

**COUNTY OF LOS ANGELES SHERIFF'S DEPARTMENT
INCIDENT REPORT**

A TRADITION OF SERVICE

DATE 07-14-01 PAGE 1 OF 8

ACTION: <input checked="" type="checkbox"/> ACTIVE <input type="checkbox"/> INACTIVE <input type="checkbox"/> PENDING	NON-CRIMINAL <input type="checkbox"/>	# OF ADULT ARRESTS <u>1</u>	# OF SUBJECT DETENTIONS <u>0</u>	URN # <u>4 01 08657</u>	RETENTION YEAR <u>0372</u>	SEQUENTIAL <u>151</u>	REPORTING DISTRICT <u>151</u>	STAT CODE
CLASSIFICATION 1 / LEVEL / STATCODE <u>POSSESSION OF UNREGISTERED ASSAULT WEAPONS, 18880(B) P.C.</u>								SEX OFFENSE VICTIM INFO? <input type="checkbox"/> YES <input checked="" type="checkbox"/> NO
CLASSIFICATION 2 / LEVEL / STATCODE <u>M/151</u>								DOMESTIC VIOLENCE <input type="checkbox"/> NON-PERSONAL (GUN, KNIFE, ETC) <input type="checkbox"/> PERSONAL (HANDS, FEET, FIST, ETC)
CLASSIFICATION 3 / LEVEL / STATCODE								INJURY <input type="checkbox"/> Major <input checked="" type="checkbox"/> Minor <input type="checkbox"/> None
DATE, TIME, DAY OF OCCURRENCE <u>07-14-01 1800 HRS. SAT.</u>				PRINTS REQUESTED <input type="checkbox"/> BY: COMPLETED <input checked="" type="checkbox"/>	TIME			
LOC. OF OCCURRENCE <u>1441 103RD ST</u>				BUS. NAME <u>N/A</u>				<input type="checkbox"/> NON-CRIMINAL

CODE: <u>V - VICTIM</u> • W - WITNESS • I - INFORMANT • R - REPORTING PARTY • P - PARTY										
CODE # of	LNAME	FNAME	MNAME	SEX	RACE	ETHNIC ORIGIN	DOB	Age		
<u>I 13</u>	<u>GARCIA</u>	<u>ADONIS</u>	<u>ESTEBAN</u>	<u>M</u>	<u>B</u>		<u>4-4-66</u>	<u>35</u>		
RES. ADDR. <u>1424 103RD ST LA</u>			CITY <u>LA</u>	ZIP <u>90047</u>	VICTIM OF OFFENSE(S) (CLASSIFICATION) #: <u>4/18</u>		RES. PHONE (Area Code) <u>323</u>	<u>777-3348</u>	Day Phone	<input checked="" type="checkbox"/>
BUS. ADDR. <u>SAME AS RESIDENCE</u>			CITY	ZIP	ENGLISH SPEAKING <input checked="" type="checkbox"/> YES <input type="checkbox"/> NO		BUS. PHONE (Area Code)		Day Phone	
CODE # of	LNAME	FNAME	MNAME	SEX	RACE	ETHNIC ORIGIN	DOB	Age		
<u>I 23</u>	<u>SIMMONS</u>	<u>ARTHUR</u>	<u>LAMONT</u>	<u>M</u>	<u>B</u>		<u>5-25-89</u>	<u>12</u>		
RES. ADDR. <u>616 E. 97TH ST LA</u>			CITY <u>LA</u>	ZIP <u>90002</u>	VICTIM OF OFFENSE(S) (CLASSIFICATION) #: <u>4/18</u>		RES. PHONE (Area Code) <u>323</u>	<u>942-8761</u>	Day Phone	<input checked="" type="checkbox"/>
BUS. ADDR. <u>"HAWTHORNE ACADEMY" SCHOOL</u>			CITY	ZIP	ENGLISH SPEAKING <input checked="" type="checkbox"/> YES <input type="checkbox"/> NO		BUS. PHONE (Area Code)		Day Phone	
							<u>LINK</u>		Day Phone	
CODE # of	LNAME	FNAME	MNAME	SEX	RACE	ETHNIC ORIGIN	DOB	Age		
<u>I 33</u>	<u>BLAKES</u>	<u>GERDY</u>	<u>ROYCE</u>	<u>M</u>	<u>B</u>		<u>11-16-93</u>	<u>7</u>		
RES. ADDR. <u>1874 CENTURY BL. LA</u>			CITY <u>LA</u>	ZIP <u>90044</u>	VICTIM OF OFFENSE(S) (CLASSIFICATION) #: <u>N/A</u>		RES. PHONE (Area Code) <u>323</u>	<u>756-3753</u>	Day Phone	<input checked="" type="checkbox"/>
BUS. ADDR. <u>"MANHATTAN PLACE" ELEM. SCHOOL</u>			CITY	ZIP	ENGLISH SPEAKING <input checked="" type="checkbox"/> YES <input type="checkbox"/> NO		BUS. PHONE (Area Code)		Day Phone	
							<u>LINK</u>		Day Phone	

CODE: <u>S - SUSPECT</u> • SJ - SUBJECT • M - PATIENT • SV - SUSPECT / VICTIM • SJ / V - SUBJECT / VICTIM									
CODE # of	LNAME	FNAME	MNAME	DRIVER'S LICENSE (STATE & No.)					
<u>S 11</u>	<u>ROSENBERGER</u>	<u>LUDOVIC</u>	<u>NMN</u>	<u>CA / N8491304</u>					
RES. ADDR. <u>1441 103RD ST L.A.</u>			CITY	ZIP <u>90047</u>	RES. PHONE (Area Code) <u>323</u>		<u>755-6426</u>		
BUS. ADDR.			CITY	ZIP	BUS. PHONE (Area Code)				

SEX <u>M</u>	RACE <u>W</u>	ETHNIC ORIGIN	HAIR <u>BRO.</u>	EYES <u>BRO.</u>	HGT. <u>508</u>	WGT. <u>220</u>	DOB <u>01-12-51</u>	Age <u>50</u>	
CHARGE <u>12880(B) P.C.</u>							WHERE DETAINED OR CITE # <u>LENNOX</u>		
AKA <u>N/A</u>			MONIKER <u>N/A</u>			BOOKING # <u>6944-687</u>			

CODE # of	LNAME	FNAME	MNAME	DRIVER'S LICENSE (STATE & No.)					
RES. ADDR.			CITY	ZIP	RES. PHONE (Area Code)				
BUS. ADDR.			CITY	ZIP	BUS. PHONE (Area Code)				
SEX	RACE	ETHNIC ORIGIN	HAIR	EYES	HGT.	WGT.	DOB	Age	
CHARGE							WHERE DETAINED OR CITE #		
AKA			MONIKER			BOOKING #			

VEHICLE #	SUSPECT STATUS	<input type="checkbox"/> IMPOUNDED	LICENSE (STATE & No.)	YEAR	MAKE	MODEL	BODY TYPE	COLOR	
	<input type="checkbox"/> VICTIM	<input type="checkbox"/> STORED	<input type="checkbox"/> OUTSTANDING						
REGISTERED OWNER			IDENTIFYING FEATURES			CHP 180 SUBMITTED:		GARAGE NAME & PH.	
						<input type="checkbox"/> YES <input checked="" type="checkbox"/> NO			

BY DEP. <u>JOHN SILVERSTEIN #30085 (94418)</u>	EMPLOYEE # <u>30085</u>	VACATION DATES <u>NO VAC</u>	DEP. <u>RUBEN LETESMA #409036 (10423)</u>	EMPLOYEE # <u>409280</u>	VACATION DATES <u>NO VAC</u>
STATION <u>LENNOX</u>	UNIT / CAR # <u>34</u>	SHIFT <u>PM 15</u>	APPROVED <u>Sgt. MARULLA</u>	DATE <u>7/15/01</u>	TIME <u>0119</u>
VICTIM DESIROUS OF PROSECUTION <input checked="" type="checkbox"/> YES <input type="checkbox"/> NO			ASSIGNMENT <u>LENNOX NIGHT D.B.</u>		
HQ NOTIFICATION REQ. <input type="checkbox"/> YES <input checked="" type="checkbox"/> NO			SPECIAL REQUEST DISTRIBUTION		
SUSP / SUBJ RELEASE APPROVED BY		TIME	PCD SUBMITTED: <input checked="" type="checkbox"/> YES <input type="checkbox"/> NO	TT B/C BY	DATE TIME

DATE: 07-14-01 TIME RECEIVED: 1750 TAG #: 164 URN #: 401-08657-0372-151 PAGE 2 OF 8
 INPUT / CHECKED NCIC, CI, ETC.: EVIDENCE ENTERED IN: PATROL: 170/99 NARCOTICS: Ledger/Pages# SAFE: Ledger/Pages# BY: LEDESMA #409056
 YES NO EVIDENCE HELD: YES NO

EVIDENCE HELD: BLOOD BULLET BULLET CASING CHECKS CLOTHES CREDIT CARDS ELECTRONIC EQUIPMENT FINGERPRINTS
 FOOTPRINTS FRAUD DOCUMENTS GSR HAIR JEWELRY MISCELLANEOUS MONEY NARCOTICS
 OTHER PRINTS PAINT PHOTOGRAPHS RAPE KIT RECEIPTS TOOLS URINE VEHICLE IMPOUNDED
 VEHICLE PARTS WEAPONS

PROPERTY CODE:	ITEM #	QUAN.	DESCRIPTION (Include kind of article, trade name, identifying numbers, physical description, material, color, condition, age and present market value)	SERIAL #	VALUE
S - STOLEN	1	1	ASSAULT RIFLE, "NOGINCO", .223 CAL, SEMI-AUTO, AK-47, SER # 845403675, W/ TWO .223 CAL MAGAZINES (1-30 RD., 1-40 RD.), N.F.D.		
S - STOLEN	2	1	CARBINE, "THOMPSON", SEMI-AUTO, MODEL 1927A, SER # 22592, W/ TWO ATTACHED .45 CAL MAGAZINES (1-50 RD., 1-30 RD.), N.F.D.		
S - STOLEN	3	1	POLAROID PICTURE DEPICTING A BLACK WOODEN STICK, APPROX. 30" LONG, N.F.D.		
S - STOLEN	4	1	POLAROID PICTURE DEPICTING A DIGITAL "MAVICA" CAMERA & DIGITAL DISC.		
S - STOLEN	5	1	1-CLEAR PLASTIC DIGITAL DISC.		

PART I STATISTICAL INFORMATION

PROPERTY			TYPE OF PROPERTY		
TYPE OF PROPERTY	STOLEN	RECOVERED	TYPE OF PROPERTY	STOLEN	RECOVERED
CLOTHING/FURS	\$	\$	JEWELRY	\$	\$
CONSUMABLE GOODS	\$	\$	LIVESTOCK	\$	\$
CURRENCY/NOTES	\$	\$	LOCAL STOLEN VEHICLES	\$	\$
FIREARMS	\$	\$	MISCELLANEOUS	\$	\$
HOUSEHOLD GOODS	\$	\$	OFFICE EQUIPMENT	\$	\$
			TV/RADIO/STEREO	\$	\$

VICTIM OF SEX CRIMES REQUEST FOR CONFIDENTIALITY
 PURSUANT TO SECTION 293(a) OF THE CALIFORNIA PENAL CODE, YOU ARE INFORMED THAT YOUR NAME WILL BECOME A MATTER OF PUBLIC RECORD, UNLESS YOU REQUEST THAT IT REMAIN CONFIDENTIAL AND NOT BE A PUBLIC RECORD, PURSUANT TO SECTION 6254 OF THE GOVERNMENT CODE.

I, _____ HEREBY (DO) (DO NOT) ELECT TO EXERCISE MY RIGHT TO PRIVACY.

SCREENING FACTORS

- | | | | | | |
|---|-------------------------------------|-------------------------------|---|-------------------------------------|-----------------------------------|
| YES <input checked="" type="checkbox"/> | NO <input type="checkbox"/> | 1. SUSPECT IN CUSTODY | YES <input checked="" type="checkbox"/> | NO <input type="checkbox"/> | 7. GENERAL SUSPECT DESCRIPTION |
| <input checked="" type="checkbox"/> | <input type="checkbox"/> | 2. SUSPECT NAMED/KNOWN | <input type="checkbox"/> | <input checked="" type="checkbox"/> | 8. GENERAL VEHICLE DESCRIPTION |
| <input type="checkbox"/> | <input checked="" type="checkbox"/> | 3. UNIQUE SUSPECT IDENTIFIERS | <input type="checkbox"/> | <input checked="" type="checkbox"/> | 9. UNIQUE M.O. OR PATTERN |
| <input type="checkbox"/> | <input checked="" type="checkbox"/> | 4. VEHICLE IN CUSTODY | <input type="checkbox"/> | <input checked="" type="checkbox"/> | 10. SIGNIFICANT PHYSICAL EVIDENCE |
| <input type="checkbox"/> | <input checked="" type="checkbox"/> | 5. UNIQUE VEHICLE IDENTIFIERS | <input type="checkbox"/> | <input checked="" type="checkbox"/> | 11. TRACEABLE STOLEN PROPERTY |
| <input type="checkbox"/> | <input type="checkbox"/> | 6. WRITER/REVIEWER DISCRETION | <input type="checkbox"/> | <input checked="" type="checkbox"/> | 12. MULTIPLE WITNESSES |

REPORT CONTINUATION - NARRATIVE

URN 401-08657-0372-151

ON 07-14-01 WE RESPONDED TO 1424
103RD ST. REGARDING A MAN WITH A GUN
CALL, TAG-164. DURING OUR RESPONSE TO
THE CALL OUR DECK (300) ADVISED US
THAT A MALE WHITE WAS POINTING AN
UNKNOWN HANDGUN (NFD) AT NEIGHBORHOOD
KIDS.

UPON OUR ARRIVAL WE CONTACTED NUMEROUS
INFORMANTS (I/1-3) WHO TOLD US THAT A
NEARBY NEIGHBOR (S/ROSENBERGER) WAS POINTING
A SILVER HANDGUN (NFD) AT THEM FROM
HIS RESIDENCE (1441 103RD ST.).

MY PARTNER (DIP. LOZEMA) ADVISED ME THAT
HE SAW THE SUSPECT (ROSENBERGER) STANDING
IN THE FRONT YARD OF 1441 103RD ST. HE
SAW S/ROSENBERGER HOLDING A LONG BLACK
CYLINDRICAL OBJECT. HE WAS HOLDING IT
WITH BOTH HANDS AS IF IT WERE A
RIFLE. AFTER SEEING US, S/ROSENBERGER RAN

401-08657-0370-151

INTO HIS RESIDENCE. AT THIS TIME WE ADVISED OUR ASSISTING UNITS OF OUR SITUATION. MOMENTS LATER S/ROSENBERGER CAME BACK OUTSIDE HIS RESIDENCE WHERE WE DETAINED HIM PENDING FURTHER INVESTIGATION.

BASED ON THE NATURE OF THE CALL, INFORMANT INFORMATION, OUR OBSERVATIONS, AND FOR THE SAFETY OF THE COMMUNITY, WE PERFORMED A PROTECTIVE SWEEP OF THE RESIDENCE. DURING THIS TIME WE LOCATED WHAT APPEARED TO BE TWO ASSAULT WEAPONS (EV. 1-2) WHICH WERE FOUND IN THE CLOSET OF THE NORTH BEDROOM OF THE RESIDENCE.

I ASKED S/ROSENBERGER IF THE WEAPONS BELONGED TO HIM, HE SAID "YES". I THEN ASKED HIM IF THE WEAPONS WERE REGISTERED AS "ASSAULT WEAPONS", HE SAID "NO, BUT THEY'RE PERFECTLY LEGAL BECAUSE I BOUGHT THE AK-47 SEVEN YEARS AGO, AND THE THOMPSON SEVEN YEARS AGO".

REPORT CONTINUATION - NARRATIVE

URN 401-08657-0370-151

WE THEN ASKED S/ROSENBERGER IF HE HAD A SILVER HANDGUN AND IF HE HAD POINTED THIS AT HIS NEIGHBORS. HE TOLD US THAT HE NEVER POINTED A GUN AT ANYBODY, BUT INSTEAD WAS CARRYING A BLACK STICK (EV. 3) WHICH WE LATER LOCATED ON HIS FRONT PORCH. HE FURTHER STATED THAT NUMEROUS MALE BLACK JUVENILES WERE THROWING ROCKS & BRICKS AT HIS RESIDENCE. HE SAID THAT HE WAS CARRYING THE BLACK STICK FOR HIS PROTECTION AND WAS ALSO TAKING PICTURES OF THE JUVENILES WITH HIS DIGITAL CAMERA (EV. 4) WHICH IS SILVER IN COLOR.

I/GARCIA TOLD US THAT HE DID NOT SEE S/ROSENBERGER WITH A GUN BUT CALLED 911 BASED ON WHAT HEARD FROM I/SIMMONS, I/BLAKES, AND NUMEROUS OTHER KIDS (NFD) IN THE NEIGHBORHOOD.

I/SIMMONS STATED THAT HE WAS WALKING WITH I/BLAKES E/B ON THE SOUTH SIDEWALK OF 103RD ST., DURING THIS TIME S/ROSENBERGER STARTED POINTING A SILVER OBJECT AT THEM WHICH THEY BELIEVED TO BE A HANDGUN. AT THIS TIME THEY BOTH RAN TO I/GARCIA'S HOUSE AND ADVISED HIM OF WHAT HAPPENED.

I/BLAKES ALSO ADDED THAT HE BELIEVED S/ROSENBERGER WAS POINTING A SILVER HANDGUN AT HIM.

I ASKED BOTH I/SIMMONS & I/BLAKES IF THEY WERE THROWING ANYTHING AT S/ROSENBERGER'S RESIDENCE. THEY BOTH SAID "NO". I THEN ASKED IF THEY WERE SURE THEY SAW A SILVER HANDGUN, THEY SAID NO BUT IT WAS DEFINITELY A SILVER METALLIC OBJECT.

REPORT CONTINUATION - NARRATIVE

URN

HOI-08657-0372-151

BASED ON THE ABOVE STATEMENTS, WE ARRESTED S/ROSENBERGER FOR POSSESSING UNREGISTERED ASSAULT WEAPONS (VIOLATION 12980(B) P.C.). WE CONFISCATED BOTH ASSAULT WEAPONS (EV. 1-2).

WE TOOK A POLAROID PICTURE OF THE BLACK STICK (EV. 3). WE ALSO PHOTOGRAPHED THE DIGITAL CAMERA (EV. 4) DUE TO THE FACT IT MAY HAVE BEEN MISTAKEN AS THE SILVER HANDGUN.

DURING OUR INVESTIGATION S/ROSENBERGER TOLD US THAT HE TOOK PICTURES OF SEVERAL JUVENILES THROWING ROCKS & BRICKS AT HIS RESIDENCE. BASED ON THIS, WE BOOKED THE DISC (EV. 5) INTO EVIDENCE.

WE TRANSPORTED S/ROSENBERGER TO LENNOX STATION, WHERE HE WAS BOOKED FOR THE INDICATED CHARGE WITH THE APPROVAL OF WATCH CMDR. LT. PLETT.

URN 401-08657-0372-151

BOTH WEAPONS WERE ENTERED INTO
AFS AS EVIDENCE BY SGT. AMANN
AT 2318 HRS.

**LOS ANGELES COUNTY SHERIFF'S DEPARTMENT
CRIME ANALYSIS INFORMATION FORM
SUSPECT/SUBJECT INFORMATION**

URN 401-08657-0372-151

SUSPECT # 1 NAME ROSENBERGER, LUDOVIC SUSPECT # _____ NAME _____
SUBJECT _____ SUBJECT _____

<p align="center">CLOTHING DESCRIPTION</p> <p><u>WHT/BLUE SHIRT, BLUE SHORTS, WHT SHOES</u></p>	<p>WRITE ONE ITEM PER DESCRIPTION</p> <p>CAP/HAT COAT/JACKET DRESS/SKIRT GLASSES GLOVES JEWELRY PANTS SHIRT/BLOUSE SHOES SHORTS OTHER</p>	<p align="center">CLOTHING DESCRIPTION</p>																																								
<table border="1" style="width:100%; border-collapse: collapse;"> <tr> <th>L</th> <th>R</th> <th>UNK</th> <th>SCARS / MARKS / TATTOOS / ODDITIES</th> </tr> <tr> <td></td> <td></td> <td></td> <td align="center"><u>N/A</u></td> </tr> <tr><td> </td><td> </td><td> </td><td> </td></tr> <tr><td> </td><td> </td><td> </td><td> </td></tr> <tr><td> </td><td> </td><td> </td><td> </td></tr> </table>	L	R	UNK	SCARS / MARKS / TATTOOS / ODDITIES				<u>N/A</u>														<table border="1" style="width:100%; border-collapse: collapse;"> <tr> <th>L</th> <th>R</th> <th>UNK</th> <th>SCARS / MARKS / TATTOOS / ODDITIES</th> </tr> <tr><td> </td><td> </td><td> </td><td> </td></tr> <tr><td> </td><td> </td><td> </td><td> </td></tr> <tr><td> </td><td> </td><td> </td><td> </td></tr> <tr><td> </td><td> </td><td> </td><td> </td></tr> </table>	L	R	UNK	SCARS / MARKS / TATTOOS / ODDITIES																
L	R	UNK	SCARS / MARKS / TATTOOS / ODDITIES																																							
			<u>N/A</u>																																							
L	R	UNK	SCARS / MARKS / TATTOOS / ODDITIES																																							
<p>SUSPECTED GANG MEMBER <input type="checkbox"/> NAME OF GANG _____</p>		<p>SUSPECTED GANG MEMBER <input type="checkbox"/> NAME OF GANG _____</p>																																								

<p>HAIR LENGTH</p> <p><input type="checkbox"/> COLLAR <input type="checkbox"/> LONG <input type="checkbox"/> SHORT <input type="checkbox"/> SHOULDER</p> <p>HAIR TYPE</p> <p><input type="checkbox"/> BALD <input type="checkbox"/> RECEDING <input checked="" type="checkbox"/> THICK <input type="checkbox"/> THINNING <input type="checkbox"/> WIG</p> <p>HAIR STYLE</p> <p><input type="checkbox"/> AFRO/NATURAL <input type="checkbox"/> BRAIDED/DREDOCKS <input type="checkbox"/> BUSHY <input type="checkbox"/> BUTCH <input type="checkbox"/> COMBED BACK <input type="checkbox"/> CURLERS <input type="checkbox"/> CURLY <input type="checkbox"/> FLAT TOP <input type="checkbox"/> GREASY <input type="checkbox"/> JHERI CURL <input type="checkbox"/> MILITARY <input type="checkbox"/> NETS <input type="checkbox"/> PONY TAIL <input type="checkbox"/> PROCESSED <input type="checkbox"/> PUNK <input type="checkbox"/> SHAVED <input checked="" type="checkbox"/> STRAIGHT <input type="checkbox"/> WAVY</p> <p>COMPLEXION</p> <p><input type="checkbox"/> ACNE/POCKED <input type="checkbox"/> ALBINO <input type="checkbox"/> DARK <input type="checkbox"/> FRECKLED <input checked="" type="checkbox"/> LIGHT/FAIR <input type="checkbox"/> MEDIUM <input type="checkbox"/> PALE <input type="checkbox"/> RUDDY <input type="checkbox"/> SALLOW <input type="checkbox"/> TANNED <input type="checkbox"/> WEATHERED <input type="checkbox"/> WRINKLED</p>	<p>FACIAL HAIR</p> <p><input type="checkbox"/> BEARD <input checked="" type="checkbox"/> CLEAN SHAVEN <input type="checkbox"/> FUZZ <input type="checkbox"/> GOATEE <input type="checkbox"/> LOWER LIP <input type="checkbox"/> MOUSTACHE <input type="checkbox"/> SIDE BURNS <input type="checkbox"/> UNSHAVEN</p> <p>TEETH</p> <p><input type="checkbox"/> BROKEN / CHIPPED <input type="checkbox"/> BRACES <input type="checkbox"/> BUCK <input type="checkbox"/> CROOKED <input checked="" type="checkbox"/> DECAYED <input type="checkbox"/> FALSE <input type="checkbox"/> GAP/SPACE <input type="checkbox"/> GOLD CAP <input type="checkbox"/> JEWELLED <input type="checkbox"/> MISSING <input type="checkbox"/> NONE <input type="checkbox"/> SILVER CAP <input type="checkbox"/> STAINED</p> <p>SPEECH</p> <p><input type="checkbox"/> ACCENT <input type="checkbox"/> DISGUISE <input type="checkbox"/> LISPS <input type="checkbox"/> MUMBLES <input checked="" type="checkbox"/> RAPID <input type="checkbox"/> RASPY <input type="checkbox"/> SLOW <input type="checkbox"/> SLURRED <input type="checkbox"/> STUTTER</p> <p>HANDED</p> <p><input type="checkbox"/> LEFT <input checked="" type="checkbox"/> RIGHT <input type="checkbox"/> BOTH</p>	<p>WEAPON FIREARM</p> <p>Style:</p> <p><input type="checkbox"/> MULTIPLE <input type="checkbox"/> BB / PELLET <input type="checkbox"/> HANDGUN <input checked="" type="checkbox"/> RIFLE <input type="checkbox"/> SAWED-OFF <input type="checkbox"/> SHOTGUN <input type="checkbox"/> SIMULATED <input type="checkbox"/> ZIP GUN</p> <p>Action:</p> <p><input type="checkbox"/> DERRINGER <input type="checkbox"/> FULLY AUTO <input type="checkbox"/> PUMP <input type="checkbox"/> REVOLVER <input checked="" type="checkbox"/> SEMI AUTO <input type="checkbox"/> SINGLE SHOT</p> <p>Barrel Type:</p> <p><input checked="" type="checkbox"/> SINGLE BARREL <input type="checkbox"/> DOUBLE BARREL <input type="checkbox"/> THREE BARREL <input type="checkbox"/> 4 OR MORE BARREL</p> <p>Color / Finish:</p> <p><input checked="" type="checkbox"/> BLUE STEEL <input type="checkbox"/> CHROME / NICKEL <input type="checkbox"/> DULL BLACK <input type="checkbox"/> RUSTED <input type="checkbox"/> STAINLESS STEEL</p> <p>Grip / Stock:</p> <p><input type="checkbox"/> ALTERED <input type="checkbox"/> BONE / PEARL / IVORY <input type="checkbox"/> COLLAPSIBLE / FOLDABLE <input type="checkbox"/> METAL / PLASTIC <input type="checkbox"/> NO GRIP <input type="checkbox"/> RUBBER / VINYL <input type="checkbox"/> TAPED <input type="checkbox"/> THUMB HOLE <input checked="" type="checkbox"/> WOOD <input type="checkbox"/> GAUGE</p> <p><input type="checkbox"/> CALIBER _____</p>	<p>KNIFE</p> <p>Style:</p> <p><input type="checkbox"/> MULTIPLE <input type="checkbox"/> BUCK <input checked="" type="checkbox"/> BUTCHER / KITCHEN <input checked="" type="checkbox"/> BIRD / DAGGER / STILETTO <input type="checkbox"/> HUNTING / BOWIE <input type="checkbox"/> SIMULATED <input checked="" type="checkbox"/> SWITCHBLADE <input type="checkbox"/> TOY</p> <p>Blade:</p> <p><input type="checkbox"/> FIXED <input type="checkbox"/> FOLDING</p> <p>CHEMICAL</p> <p><input type="checkbox"/> CAUSTIC <input type="checkbox"/> INFECTIOUS <input type="checkbox"/> MACE <input type="checkbox"/> PEPPER SPRAY <input type="checkbox"/> SIMULATED <input type="checkbox"/> TEAR GAS <input type="checkbox"/> TOXIC</p> <p>BLUNT INSTRUMENT</p> <p><input type="checkbox"/> BASEBALL BAT <input type="checkbox"/> BILLY CLUB <input type="checkbox"/> BRASS KNUCKLES <input type="checkbox"/> BRICK / ROCK / BOTTLE <input type="checkbox"/> CLUB / BLUDGEON <input type="checkbox"/> HAMMER / TOOL <input type="checkbox"/> NUNCHAKUS <input type="checkbox"/> TIRE IRON</p> <p>CUT / STAB</p> <p><input type="checkbox"/> BAYONET / SWORD <input type="checkbox"/> BOTTLE / GLASS <input type="checkbox"/> ICE PICK <input type="checkbox"/> MACHETE <input type="checkbox"/> RAZOR <input type="checkbox"/> SCREWDRIVER <input type="checkbox"/> THROWING STARS</p> <p>EXPLOSIVE / INCENDIARY</p> <p><input type="checkbox"/> FIREWORKS <input type="checkbox"/> MOLOTOV COCKTAIL</p>	<p>OTHER WEAPON</p> <p><input type="checkbox"/> BODILY FORCE <input type="checkbox"/> LIGATURE <input type="checkbox"/> SLING SHOT <input checked="" type="checkbox"/> SYRINGE <input type="checkbox"/> TASER / STUN GUN</p> <p>RELATIONSHIP OF VICTIM TO SUSPECT:</p> <p>V# _____ V# _____ ACQUAINTANCE V# _____ V# _____ BABYSITTEE (PERSONS WATCHED/BABY) V# _____ V# _____ BOYFRIEND/GIRLFRIEND V# _____ V# _____ CHILD V# _____ V# _____ CHILD OF BOYFRIEND OR GIRLFRIEND V# _____ V# _____ COMMON-LAW SPOUSE V# _____ V# _____ EMPLOYEE V# _____ V# _____ EMPLOYER V# _____ V# _____ EX-SPOUSE V# _____ V# _____ FRIEND V# _____ V# _____ GRANDCHILD V# _____ V# _____ GRANDPARENT V# _____ V# _____ HOMOSEXUAL RELATIONSHIP V# _____ V# _____ IN-LAW V# _____ V# _____ NEIGHBOR V# _____ V# _____ OTHER FAMILY MEMBER V# _____ V# _____ OTHERWISE KNOWN V# _____ V# _____ PARENT V# _____ V# _____ RELATIONSHIP UNKNOWN V# _____ V# _____ SIBLING (BROTHER OR SISTER) V# _____ V# _____ SPOUSE V# _____ V# _____ STEPCHILD V# _____ V# _____ STEPPARENT V# _____ V# _____ STEPSIBLING (STEPBROTHER OR STEPSISTER) V# _____ V# _____ VICTIM WAS OFFENDER V# _____ V# _____ VICTIM WAS STRANGER</p>
---	---	---	--	--

LOS ANGELES COUNTY SHERIFF'S DEPARTMENT
 CRIME ANALYSIS INFORMATION FORM -- M. O. FACTORS

URN 401-08657-0372-151

<p>AREA</p> <p><input type="checkbox"/> AIRPORT</p> <p><input type="checkbox"/> BEACH</p> <p><input type="checkbox"/> COMMERCIAL</p> <p><input type="checkbox"/> CONSTRUCTION SITE</p> <p><input type="checkbox"/> DESERT</p> <p><input type="checkbox"/> DRIVEWAY</p> <p><input type="checkbox"/> FREEWAY/HIGHWAY</p> <p><input type="checkbox"/> GOLF COURSE</p> <p><input type="checkbox"/> HARBOR</p> <p><input type="checkbox"/> INDUSTRIAL/WHOLESALE</p> <p><input type="checkbox"/> MOUNTAINS/FOOTHILLS</p> <p><input type="checkbox"/> OCEAN</p> <p><input type="checkbox"/> OPEN FIELD</p> <p><input type="checkbox"/> PARK</p> <p><input checked="" type="checkbox"/> RESIDENTIAL</p> <p><input type="checkbox"/> RIVER</p> <p><input type="checkbox"/> RURAL/ISOLATED</p> <p><input type="checkbox"/> SCHOOL GROUNDS</p> <p><input type="checkbox"/> SHOPPING CENTER</p> <p><input type="checkbox"/> STREET/ALLEY</p> <p><input type="checkbox"/> VACANT LOT</p> <p><input type="checkbox"/> WATER/LAKE</p> <p>STRUCTURE: RESIDENTIAL</p> <p><input type="checkbox"/> APARTMENT</p> <p><input type="checkbox"/> CONDO/TOWNHOUSE</p> <p><input type="checkbox"/> CONVALESCENT HOSPITAL</p> <p><input type="checkbox"/> DUPLEX</p> <p><input type="checkbox"/> MOBILE HOME</p> <p><input checked="" type="checkbox"/> SINGLE FAMILY</p> <p><input type="checkbox"/> VESSEL/BOAT</p> <p>STRUCTURE: NON-RESIDENTIAL</p> <p><input type="checkbox"/> BANK/FINANCE</p> <p><input type="checkbox"/> BAR</p> <p><input type="checkbox"/> BUSINESS OFFICE</p> <p><input type="checkbox"/> CARGO CONTAINER</p> <p><input type="checkbox"/> CATERING TRUCK</p> <p><input type="checkbox"/> ENTERTAIN/RECREATE</p> <p><input type="checkbox"/> FAST FOOD</p> <p><input type="checkbox"/> GAS STATION</p> <p><input type="checkbox"/> HOSPITAL</p> <p><input type="checkbox"/> HOTEL/MOTEL</p> <p><input type="checkbox"/> INDUS/MFG/WHSE</p> <p><input checked="" type="checkbox"/> JAIL / PRISON</p> <p><input type="checkbox"/> JEWEL/COIN/PAWN</p> <p><input type="checkbox"/> LIQUOR</p> <p><input checked="" type="checkbox"/> MARKET</p> <p><input type="checkbox"/> MINI/MART</p> <p><input type="checkbox"/> NURSING FACILITY</p> <p><input type="checkbox"/> PARKING STRUCT/LOT</p> <p><input type="checkbox"/> PHARM/MED/DENTAL</p> <p><input type="checkbox"/> PUBLIC BUILDING</p> <p><input type="checkbox"/> RELIGIOUS BUILDING</p> <p><input type="checkbox"/> RESTAURANT</p> <p><input type="checkbox"/> RETAIL GOODS</p> <p><input type="checkbox"/> RETAIL SERV/REPAIR</p> <p><input type="checkbox"/> SCHOOL</p> <p><input type="checkbox"/> STORAGE / RENTAL</p> <p><input type="checkbox"/> VEHICLE-COMMRL</p> <p><input type="checkbox"/> VESSEL/BOAT</p> <p><input type="checkbox"/> VIDEO/MUSIC</p> <p>TARGET: RESIDENTIAL</p> <p><input checked="" type="checkbox"/> ATTIC</p> <p><input type="checkbox"/> BEDROOM</p> <p><input type="checkbox"/> DINING ROOM</p> <p><input type="checkbox"/> GARAGE/PKG AREA</p> <p><input type="checkbox"/> HALLWAY</p> <p><input type="checkbox"/> KITCHEN</p> <p><input type="checkbox"/> LAUNDRY ROOM</p> <p><input type="checkbox"/> LIVING/FAMILY ROOM</p> <p><input type="checkbox"/> MAIL BOX</p> <p><input type="checkbox"/> PATIO/PORCH</p> <p><input type="checkbox"/> SAFE/BOX</p> <p><input type="checkbox"/> STORAGE/SHED</p> <p><input type="checkbox"/> STABLES/TACK ROOM</p> <p><input type="checkbox"/> VEHICLE</p>	<p>TARGET: NON-RESIDENTIAL</p> <p><input type="checkbox"/> AUTOMATED TELLER</p> <p><input type="checkbox"/> CASH REG/DRAWER</p> <p><input type="checkbox"/> CLASS RM/SUPPLIES</p> <p><input type="checkbox"/> COIN OP MACHINE</p> <p><input type="checkbox"/> DISPLAY ITEMS</p> <p><input type="checkbox"/> OFFICE</p> <p><input type="checkbox"/> SAFE/BOX</p> <p><input type="checkbox"/> SNACK BAR</p> <p><input type="checkbox"/> STORAGE LOCKER</p> <p><input checked="" type="checkbox"/> VEHICLE</p> <p><input type="checkbox"/> VESSEL</p> <p><input checked="" type="checkbox"/> BICYCLIST</p> <p><input type="checkbox"/> CUSTOMER</p> <p><input type="checkbox"/> ELDER/SENIOR CITIZEN</p> <p><input type="checkbox"/> DISABLED PERSON</p> <p><input type="checkbox"/> OWNER/EMPLOYEE</p> <p><input type="checkbox"/> PEDESTRIAN</p> <p><input type="checkbox"/> TRANSIENT</p> <p><input type="checkbox"/> VICTIM IN VEHICLE</p> <p>POINT OF ENTRY/EXIT</p> <p>IN EX</p> <p><input type="checkbox"/> FRONT</p> <p><input type="checkbox"/> REAR</p> <p><input type="checkbox"/> SIDE</p> <p><input type="checkbox"/> GROUND LEVEL</p> <p><input type="checkbox"/> UPPER LEVEL</p> <p><input type="checkbox"/> ADJACENT BLDG</p> <p><input type="checkbox"/> BASEMENT</p> <p><input type="checkbox"/> DOOR/SCREEN</p> <p><input type="checkbox"/> DUCT/VENT</p> <p><input checked="" type="checkbox"/> FENCE/GATE</p> <p><input type="checkbox"/> FIREPLACE</p> <p><input type="checkbox"/> FLOOR</p> <p><input checked="" type="checkbox"/> GARAGE</p> <p><input type="checkbox"/> GLASS DOOR</p> <p><input type="checkbox"/> HOUSE BEING FUMIGATED</p> <p><input type="checkbox"/> LOUVRE</p> <p><input type="checkbox"/> MAIL SLOT</p> <p><input type="checkbox"/> PET DOOR</p> <p><input type="checkbox"/> ROOF/SKYLIGHT</p> <p><input type="checkbox"/> SLIDING GLASS DR</p> <p><input type="checkbox"/> WALL</p> <p><input type="checkbox"/> WINDOW/SCREEN</p> <p>VEHICLE ENTRY/EXIT</p> <p>IN EX</p> <p><input type="checkbox"/> CAMPER/SHELL/MOTORHOME</p> <p><input type="checkbox"/> CONVERTIBLE</p> <p><input type="checkbox"/> DOOR</p> <p><input type="checkbox"/> DRIVER SIDE</p> <p><input type="checkbox"/> HOOD</p> <p><input checked="" type="checkbox"/> PASSENGER SIDE</p> <p><input type="checkbox"/> SUNROOF</p> <p><input type="checkbox"/> TRUCK BED</p> <p><input checked="" type="checkbox"/> TRUNK</p> <p><input type="checkbox"/> WINDOW</p> <p><input type="checkbox"/> WINDOWING</p> <p>METHOD OF ENTRY</p> <p><input type="checkbox"/> ATTEMPT ONLY</p> <p><input type="checkbox"/> BODILY FORCE</p> <p><input type="checkbox"/> CUT</p> <p><input type="checkbox"/> HID IN BUILDING</p> <p><input type="checkbox"/> KICKED</p> <p><input type="checkbox"/> KNOB TWIST</p> <p><input type="checkbox"/> LET IN/RUSE</p> <p><input type="checkbox"/> LOCK BOX</p> <p><input type="checkbox"/> LOCK CUT/BROKEN</p> <p><input type="checkbox"/> LOCK PUNCHED</p> <p><input checked="" type="checkbox"/> LOCK SLIP/KEY/PICK</p> <p><input type="checkbox"/> NO FORCE</p> <p><input checked="" type="checkbox"/> OPEN/UNLOCKED</p> <p><input type="checkbox"/> PHONE</p> <p><input type="checkbox"/> PRIED</p> <p><input type="checkbox"/> REMOVED</p> <p><input type="checkbox"/> SMASHED</p> <p><input type="checkbox"/> TUNNELED</p> <p><input type="checkbox"/> UNBOLTED GATE</p>	<p>METHOD OF ENTRY: TOOLS USED</p> <p><input type="checkbox"/> BODILY FORCE</p> <p><input type="checkbox"/> BOLT CUTTER</p> <p><input type="checkbox"/> BRICK/ROCK</p> <p><input type="checkbox"/> CHANNEL LOCK/PLIERS</p> <p><input type="checkbox"/> CUTTING INSTRUMENT</p> <p><input type="checkbox"/> ELECTRONIC DEVICE</p> <p><input type="checkbox"/> GLASS CUTTER</p> <p><input checked="" type="checkbox"/> KEY</p> <p><input type="checkbox"/> PRY TOOL</p> <p><input checked="" type="checkbox"/> SAW/CHAIN DRILL</p> <p><input type="checkbox"/> SLIDE HAMMER</p> <p><input type="checkbox"/> SLIP DEVICE</p> <p><input type="checkbox"/> VEHICLE</p> <p>SECURITY SYSTEM</p> <p><input type="checkbox"/> NONE</p> <p><input type="checkbox"/> AUDIBLE ALARM</p> <p><input type="checkbox"/> CAMERA</p> <p><input type="checkbox"/> CRIME WATCH</p> <p><input type="checkbox"/> DOG</p> <p><input checked="" type="checkbox"/> FENCE/BARS</p> <p><input type="checkbox"/> GUARD SERVICE</p> <p><input type="checkbox"/> OPERATION ID</p> <p><input checked="" type="checkbox"/> OUTSIDE LIGHTING</p> <p><input type="checkbox"/> SECURITY SIGN/STICKER</p> <p><input type="checkbox"/> SILENT ALARM</p> <p><input type="checkbox"/> SPECIAL LOCKS/DEADBOLT</p> <p><input type="checkbox"/> WINDOW BARS</p> <p>SUSPECT ACTIONS</p> <p><input type="checkbox"/> ATE/DRANK ON PREMISES</p> <p><input type="checkbox"/> CASED LOCATION</p> <p><input type="checkbox"/> DEFECATED / URINATED</p> <p><input type="checkbox"/> DEMAND NOTE USED</p> <p><input type="checkbox"/> DEMANDED DRUGS / MONEY / ETC.</p> <p><input type="checkbox"/> DISABLED PHONE</p> <p><input type="checkbox"/> DISABLED POWER</p> <p><input type="checkbox"/> DISABLED SECURITY SYSTEM</p> <p><input type="checkbox"/> DISABLED VEHICLE</p> <p><input type="checkbox"/> EXCESSIVE FORCE</p> <p><input type="checkbox"/> FIRED WEAPON</p> <p><input type="checkbox"/> FONDLED SELF</p> <p><input type="checkbox"/> GRAFFITI</p> <p><input type="checkbox"/> HID IN BUILDING</p> <p><input type="checkbox"/> IGNITION PUNCHED</p> <p><input type="checkbox"/> JUMPED THE COUNTER</p> <p><input type="checkbox"/> KNEW LOC OF HIDDEN CASH</p> <p><input type="checkbox"/> MASK WORN</p> <p><input type="checkbox"/> MASTERBAT. / EJAC.</p> <p><input type="checkbox"/> PHOTOGRAPHED / VIDEOED</p> <p><input type="checkbox"/> PILLOWCASE TAKEN / USED</p> <p><input type="checkbox"/> POLICE SCANNER USED</p> <p><input type="checkbox"/> RANSACKED</p> <p><input type="checkbox"/> RECORDED / LOGGED EVENTS</p> <p><input type="checkbox"/> RIPPED / CUT CLOTHING</p> <p><input type="checkbox"/> SELECTIVE PROPERTY TAKEN</p> <p><input type="checkbox"/> SMOKED</p> <p><input type="checkbox"/> TAKEOVER</p> <p><input type="checkbox"/> TOOK CONCEALABLES</p> <p><input type="checkbox"/> USED MULTIPLE WEAPONS</p> <p><input type="checkbox"/> VEH. USED TO REMOVE PROPERTY</p> <p><input type="checkbox"/> VANDALIZED</p> <p><input type="checkbox"/> VICTIM'S NAME USED</p> <p><input type="checkbox"/> VICTIM'S TOOLS USED</p> <p><input type="checkbox"/> WASHED CLOTHING / BEDDING</p> <p><input type="checkbox"/> WIPED SCENE AFTER CRIME</p> <p><input checked="" type="checkbox"/> 1230 (B) P.L.</p> <p>SUSPECT WAS/HAD:</p> <p><input type="checkbox"/> ALCOHOL ON BREATH</p> <p><input type="checkbox"/> ANGRY</p> <p><input type="checkbox"/> APOLOGETIC</p> <p><input type="checkbox"/> BAD BREATH</p> <p><input type="checkbox"/> BODY ODOR / UNUSUAL ODOR</p> <p><input type="checkbox"/> GANG-RELATED</p> <p><input type="checkbox"/> INTIMIDATE/COERCE</p> <p><input checked="" type="checkbox"/> NEVER SPOKE / QUIET</p> <p><input type="checkbox"/> POLYGLIND</p> <p><input type="checkbox"/> PROFANITY</p> <p><input type="checkbox"/> QUOTES, UNUSUAL</p> <p><input type="checkbox"/> RAGE</p> <p><input type="checkbox"/> TRUST VIOLATION</p> <p><input type="checkbox"/> UNDER INFLUENCE</p>	<p>SUSPECT PRETENDED TO BE:</p> <p><input type="checkbox"/> BUSINESS PERSON</p> <p><input type="checkbox"/> CONVERSATION / BEFRIENDED</p> <p><input type="checkbox"/> CUSTOMER</p> <p><input type="checkbox"/> DELIVERY PERSON</p> <p><input type="checkbox"/> FAMILY MEMBER</p> <p><input type="checkbox"/> FIND MONEY</p> <p><input type="checkbox"/> HANDICAPPED</p> <p><input type="checkbox"/> LEND ASSISTANCE</p> <p><input checked="" type="checkbox"/> NEED ASSISTANCE OR EMERGENCY</p> <p><input type="checkbox"/> NEED TOILET / PHONE / WATER</p> <p><input type="checkbox"/> OFFERED GOODS / SERVICES</p> <p><input checked="" type="checkbox"/> POLICE / SECURITY</p> <p><input type="checkbox"/> POSITION OF TRUST</p> <p><input type="checkbox"/> REPAIR PERSON</p> <p><input type="checkbox"/> SALES PERSON</p> <p><input type="checkbox"/> SEEK EMPLOYMENT</p> <p><input type="checkbox"/> SOLICIT DONATIONS</p> <p><input type="checkbox"/> UTILITY EMPLOYEE</p> <p>VICTIM WAS:</p> <p><input type="checkbox"/> ASKED TO POSE / MODEL</p> <p><input type="checkbox"/> BLINDFOLDED</p> <p><input type="checkbox"/> BOUND / GAGGED</p> <p><input type="checkbox"/> BURNED</p> <p><input type="checkbox"/> CUT / STABBED</p> <p><input type="checkbox"/> DISTRACTED</p> <p><input type="checkbox"/> DRUGGED / SEDATED</p> <p><input type="checkbox"/> EXPLOITED</p> <p><input type="checkbox"/> FACE COVERED</p> <p><input type="checkbox"/> FOLLOWED</p> <p><input type="checkbox"/> FONDLED</p> <p><input type="checkbox"/> FORCED TO DISROBE</p> <p><input type="checkbox"/> FORCED TO FONDLE SUSPECT</p> <p><input type="checkbox"/> FORCED TO LIE ON FLOOR</p> <p><input type="checkbox"/> FORCED TO MASTURBATE</p> <p><input type="checkbox"/> FORCED TO MOVE</p> <p><input type="checkbox"/> FORCED TO ORALLY COPULATE SUSPECT</p> <p><input type="checkbox"/> GANG RELATED</p> <p><input type="checkbox"/> HANDCUFFED</p> <p><input type="checkbox"/> INJURED / HIT</p> <p><input type="checkbox"/> LOCKED IN</p> <p><input type="checkbox"/> MADE TO COUNT</p> <p><input type="checkbox"/> PINCHED</p> <p><input type="checkbox"/> PISTOL WHIPPED</p> <p><input type="checkbox"/> SHOT</p> <p><input type="checkbox"/> SLAPPED</p> <p><input type="checkbox"/> THREATENED</p> <p><input type="checkbox"/> TORTURED / MUTILATED</p> <p>BIAS-MOTIVATED INCIDENT:</p> <p>RACIAL</p> <p><input type="checkbox"/> ANTI - WHITE</p> <p><input type="checkbox"/> ANTI - BLACK</p> <p><input type="checkbox"/> ANTI - AMERICAN INDIAN / ALASKAN NATIVE</p> <p><input type="checkbox"/> ANTI - ASIAN / PACIFIC ISLANDER</p> <p><input type="checkbox"/> ANTI - MULTIRACIAL GROUP</p> <p>RELIGIOUS</p> <p><input type="checkbox"/> ANTI - JEWISH</p> <p><input type="checkbox"/> ANTI - CATHOLIC</p> <p><input type="checkbox"/> ANTI - PROTESTANT</p> <p><input type="checkbox"/> ANTI - ISLAMIC (MOSLEM)</p> <p><input type="checkbox"/> ANTI - OTHER RELIGION</p> <p><input type="checkbox"/> ANTI - MULTIRELIGIOUS GROUP</p> <p><input type="checkbox"/> ANTI - ATHEISM / AGNOSTICISM</p> <p>ETHNICITY / NATIONAL ORIGIN</p> <p><input type="checkbox"/> ANTI - ARAB</p> <p><input type="checkbox"/> ANTI - HISPANIC</p> <p><input type="checkbox"/> ANTI - OTHER ETHNICITY / NATIONAL ORIGIN</p> <p>SEXUAL</p> <p><input type="checkbox"/> ANTI - MALE HOMOSEXUAL (GAY)</p> <p><input type="checkbox"/> ANTI - FEMALE HOMOSEXUAL (LESBIAN)</p> <p><input type="checkbox"/> ANTI - HOMOSEXUAL GAYS & LESBIANS)</p> <p><input type="checkbox"/> ANTI - HETEROSEXUAL</p> <p><input type="checkbox"/> ANTI - BISEXUAL</p> <p>GENDER</p> <p><input type="checkbox"/> ANTI - MALE</p> <p><input type="checkbox"/> ANTI - FEMALE</p> <p>DISABILITY</p> <p><input type="checkbox"/> ANTI - MENTAL</p> <p><input type="checkbox"/> ANTI - PHYSICAL</p>
--	--	---	--

COUNTY OF LOS ANGELES-SHERIFF'S DEPARTMENT-SUPPLEMENTARY REPORT

DATE: 07-14-2001

FILE: 401-08657-0372-151

C: Possession of an Assault Weapon, 12280(b) PC

ACTION: ACTIVE/Additional Information

V:

S: Rosenberger, Ludovic MW/01-12-1951 Booking # 6944-687

NARRATIVE

While working the Night Detective Unit at Lennox Station, I was contacted by Deputies Ruben Ledesma and John Silverstein. They had called me from the arrest scene and requested instructions regarding two assault rifles they had recovered in a protective sweep of the suspect's residence, while on a "man with a gun" call. Neither weapon was registered in AFS.

In reviewing the requirements of 12280(b) PC, the suspect was in violation for possessing a "Thompson" carbine rifle, which by definition under 12276.1 PC was outlawed because of the pistol grip, the detachable magazines and the flash suppressor. This is clearly depicted in the photograph below, wherein Deputy Ledesma is holding the "Thompson."



The suspect was also in violation of possessing an AK-47, which is specifically listed in the ban under 12276 PC, and not just by the definition of 12276.1 PC



The suspect told the deputies that he had purchased the AK-47 fifteen years ago and the "Thompson" seven years ago. The provisions of 12280(b) PC state that if the suspect can provide proof that the assault weapon was legally possessed prior to June 1st of 1989, that the first violation of the section could be reduced. If the suspect were able to provide receipts for the times he claimed he purchased the weapons, he "might" be able to receive a reduction with respect to the AK-47. However, the "Thompson," by the suspect's own admission, was allegedly purchased after June 1st, 1989. Therefore, a reduction pursuant to the code is not provided for.

Regardless of the suspect's claims about actions of the neighborhood kids that brought the response of deputy personnel, I informed the deputies and their sergeant that a felony arrest was in fact justified and required of them in that they had reason to believe a felony had taken place. The deputies took the suspect into custody.

With respect to the suspect, I have known him through field contacts I have had with

him over the last ten years. The suspect has had an on-going dispute with his neighbors ever since I have known him, and he has made numerous complaints about the other people in his neighborhood. These complaints have ranged from unsubstantiated drug dealers, weapons violations, noise, rocks being thrown at his house, gang members, loud music to baseballs landing in his yard "on purpose."

Notwithstanding any validity or lack of validity to the previous complaints made by the suspect in this case, this Investigator is extremely concerned to learn that the suspect was armed with two assault rifles. The suspect's previously demonstrated anger towards his neighbors, coupled by his weapons armament, pose a serious risk to the safety of the community.

Based on the above, it is my strongest recommendation to the Inglewood District Attorney's Office that this case be issued a felony complaint alleging a violation of 12280(b) PC.

APPROVED: SGT DICK MILLER #062339

BY: DET. MARK RENFROW #274578

ASSIGNED: LENNOX DETECTIVE BUREAU

COUNTY OF LOS ANGELES-SHERIFF'S DEPARTMENT-SUPPLEMENTARY REPORT**DATE:** 08-10-2001**FILE:** 401-08657-0372-151**C:** Possession of an Assault Weapon, 12280(b) PC**ACTION:** ACTIVE/Additional Information; Search Warrant Served**V:****S:** Rosenberger, Ludovic MW/01-12-1951 Booking # 6944-687NARRATIVE

On 08-03-2001, the Honorable Judge Rodney Forneret of the Inglewood Superior Court (Division 5) signed a Search Warrant for additional weapons and ammunition at the suspect's home.

On 08-09-2001 at 1900 hours, I was accompanied by Sergeant Claudine Sanchez, Deputy Ruben Ledesma, Deputy John Silverstein, Deputy Steve Longan, and Deputy Joe Garrido in going to 1441 W 103rd St (suspect's residence) to serve the warrant. Upon arrival, Sgt. Sanchez telephoned the suspect and advised him that we had a Search Warrant for his house. He was instructed to exit, and he complied. Additionally, the suspect's mother exited the house.

Although the house was allegedly now empty (although we couldn't be sure because several neighbors have reported that the suspect sometimes has a male friend at the location), knock and notice was conducted in accordance with PC 844.

Entry was made without incident and the location was searched.

The northwest bedroom was searched by Deputies Ledesma and Silverstein. In the closet, they located a Mosin-Nagant M44 rifle (with attached bayonet). They also located two (2) loaded cal .223 magazines in the same closet. Additionally, Deputy Ledesma found a loaded cal .45 drum for the previously seized "Tommy Gun" under the couch in the living room.

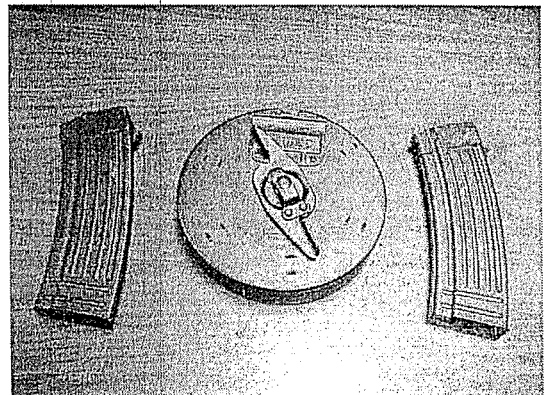
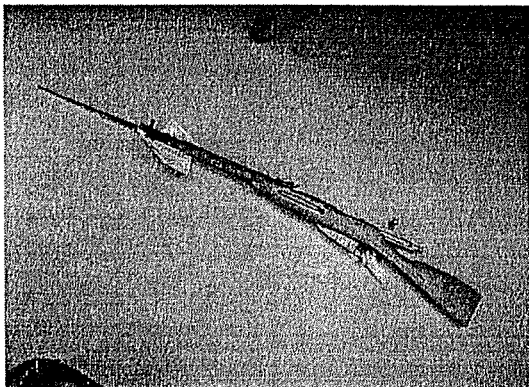

Inside the garage, Deputy Garrido and I located two pistols, that were each separately wrapped in black plastic adjacent to the northwest wall behind a red vehicle, near the trunk. Both the Browning cal .380 pistol and the Kimel Industries 9mm pistol (Tec-9 copy) had accompanying loaded magazines.

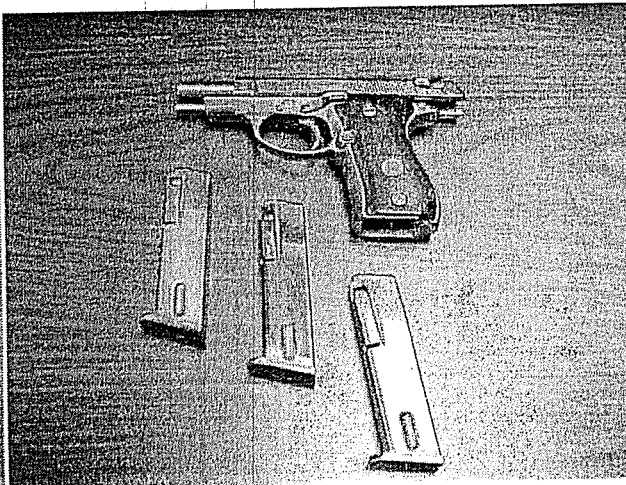
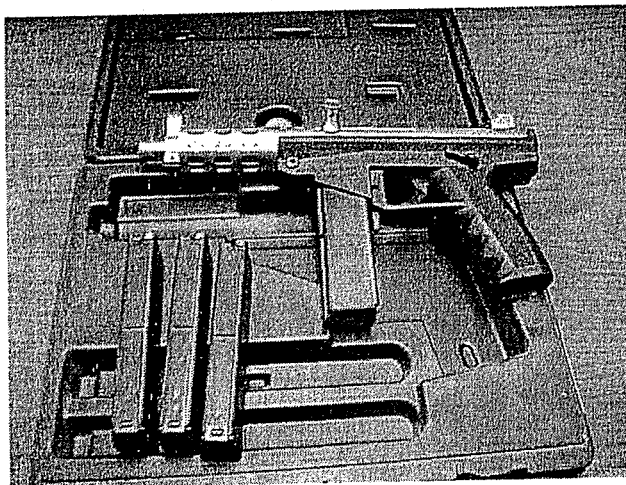

Both of the above pistols were registered to the suspect in AFS, however it remains unknown in the Kimel 9mm (above left) had further been registered as an "Assault Weapon." We were prohibited from asking the suspect questions about this pistol because I had previously received notice from the suspect's attorney that the suspect was not to speak to us without representation in this case.

It should be noted that the Browning cal .380 (above right) is of the same description as given in the initial call of 07-14-2001. This gave credence to the observations made by the witnessing children of the same day. Furthermore, I found it suspicious that the only weapons that could have been the one of the ones seen on 07-14-2001 were now wrapped in plastic in the garage, as if they were being hidden or readied for disposal with use of the aforementioned vehicle. All of the suspect's other weapons and accompanying ammunition were located in the house, and were not wrapped up in bags.

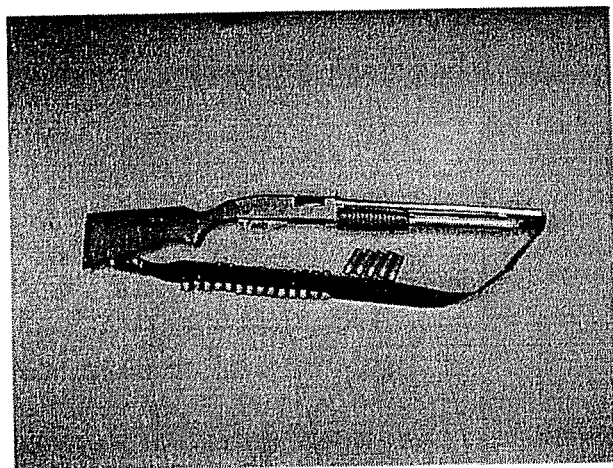

Inside the livingroom behind the hall door, Deputy Garrido located a loaded Winchester 12 gauge shotgun. This shotgun additionally had a sling with a bandoleer of ammunition.

The previously mentioned M44 rifle and the shotgun (depicted on the left) had no record in AFS, although there is currently no legal requirement for these particular type weapons to be registered.

All of the above seized weapons and ammunition were ultimately turned over to me and I later booked them into evidence at Lennox Station (book 170, page 142 & 143).

It should be noted that while surveying the location, I saw numerous boxes of assorted ammunition in the closet of the northwest bedroom. I also saw a display board on the wall of the same bedroom. This display board included nunchakus, a blow gun (for darts), a metal replica hand grenade (inert), gas masks, knives, and other military type items.

I did not seize the items on the display board, although some of the items were clearly a violation of PC 12020(a). Because the items were affixed to a display board, it did not appear likely that they were for ready usage. Additionally, I did not seize the additional ammunition, because we had already recovered ammunition in the loaded magazines, and it appeared that all weaponry that could use the ammunition that was left had already been seized. However, I am prepared to testify to my observations regarding the PC 12020(a) violations and to seek an additional Search Warrant, if requested by the District Attorney's Office.

The suspect was issued a receipt for the property that was seized pursuant to the Search Warrant. The receipt has one error, in that it states that the Browning pistol is a 9mm. It should read that the pistol is a cal .380.

Lastly, it should be noted that numerous citizens in the neighborhood approached us prior to leaving. They were expressing sincere gratitude to us for removing the weapons from the suspect's residence. We were told that the suspect had an extensive history of aggression towards neighbors, and they had seen the suspect with weapons in the past. Several neighbors told us they were willing to be contacted in the future for anything regarding the suspect's activities.

APPROVED: SGT DICK MILLER #062339

BY: DET. MARK RENFROW #274578

ASSIGNED: LENNOX DETECTIVE BUREAU

COUNTY OF LOS ANGELES-SHERIFF'S DEPARTMENT-SUPPLEMENTARY REPORT**DATE:** 07-28-2001**FILE:** 401-08657-0372-151**C:** Possession of an Assault Weapon, 12280(b) PC**ACTION:** ACTIVE/Additional Information**V:****S:** Rosenberger, Ludovic MW/01-12-1951 Booking # 6944-687**NARRATIVE**

The purpose of this report is to provide additional active information regarding the incident that led to the protective sweep and the recovery of the assault weapons. I was contacted today by Detective Renfrow regarding this case. He had some questions as to the purpose of the protective sweep, in lieu of securing the location and seeking a search warrant. I told him the following:

Upon arriving on scene on 07-14-2001, we contacted the informants who told us that the suspect had been pointing a silver handgun at the local children. Additionally, I saw the suspect standing in his front yard with what I believed was a rifle. After the suspect looked in our direction, he ran inside his residence holding what I believed was a rifle. The suspect is well known by the deputies assigned at Lennox Station as having a continuous hostile relationship with the African Americans in the neighborhood, and I had been previously briefed about the suspect and his situation by Detective Renfrow several years ago, when he (Detective Renfrow) was my field Training Officer.

Based on my previously learned information about the suspect, coupled by my direct observations, I believed that the suspect's problems with his neighbors had culminated today in an armed confrontation. I was concerned enough to request assistance from other responding units, which meant that these units were to come to the location with lights and sirens (code-3). This was documented by Detective Renfrow when he made a copy of the radio traffic on cassette tape.

As the units were responding, the suspect exited his house where he was detained. As he did so, I saw the suspect's mother standing in the doorway of the residence. In addition to the suspect, Detective Renfrow and other deputies at Lennox Station had previously informed me that the suspect's mother also had a history of problems with the neighbors. In fact, I have personally handled calls involving the Rosenberger residence since my assignment at Lennox Station.

Because I saw the suspect take what I believed to be a rifle inside the house, the fact that the information we had received on scene was that the suspect had been pointing a handgun, the fact that there is a history of the suspect and his mother having problems with persons in the neighborhood, the fact that the mother was inside the

residence when the suspect came outside, the fact that it appeared the problems had escalated into an armed confrontation, and the fact that I did not know who else the suspect might have enlisted to assist him in his confrontation with the neighborhood, I believed there was a risk to community and officer safety inside the suspect's residence.

I believed that there was the rifle I saw the suspect carrying inside the residence, the handgun reported by the informants inside the suspect's residence, and I knew the suspect's mother was inside the residence. Because of the obvious escalation that had occurred, I believed the suspect might have had somebody else inside the residence that was present to assist him in what was apparently now an "armed war" against the neighborhood.

Based on all of the above, I believed there was sufficient cause to make a protective sweep of the residence to ensure there was nobody else inside that could be hiding or that could use the weapons observed to harm deputy personnel or members of the neighboring community. During the protective sweep, the two assault rifles were recovered.

The fact that this was a "protective sweep" and not a search, was documented by the evidence that was recovered itself. Although the first report by Silverstein indicated that two cal. 223 magazines were recovered with the AK-47, this was in error. My examination of the magazines indicated that one was a cal .223, but the other one was a 7.62mm (cal .30). In fact, I tried the magazines, and only the cal .223 fit the AK-47. Had this been a "search" and not a "protective sweep," we would have searched for the weapon that went with the second magazine. Additionally, the handgun reportedly seen in possession of the suspect was not searched for. As of the writing of this report, it is my current belief that the suspect has additional evidence and weaponry inside his residence.

As for the claims that the "silver handgun" seen in possession of the suspect was in reality a digital camera, and that the rifle I saw him holding was a black stick on the porch, these were self-serving statements made by the suspect himself. They became evidence in this case based on our impartial approach to the investigation, and the possibility that they could be used as evidence in his defense.

Attached with this report are copied of the MDT logs for the last year, where units were dispatched to the Rosenberger house at their. This does not include calls made to the Lennox C.O.P.'s team, or the times the suspect and/or his mother have come to Lennox station in person.

APPROVED:  BY: DEP. RUBEN LEDESMA # 409036
ASSIGNED: LENNOX DETECTIVE BUREAU

COUNTY OF LOS ANGELES-SHERIFF'S DEPARTMENT-SUPPLEMENTARY REPORT**DATE:** 10-04-2001**FILE:** 401-08657-0372-151**C:** Possession of an Assault Weapon, 12280(b) PC**ACTION:** ACTIVE/Additional Information**V:****S:** Rosenberger, Ludovic MW/01-12-1951 Booking # 6944-687**NARRATIVE**

In preparation for the preliminary hearing in the case of People vs. Ludovic Rosenberger, I decided to contact the California Department of Justice regarding all of the weapons seized from the Rosenberger home. This was in response to unsolicited comments from Rosenberger during the Search Warrant that "his attorney told him all of his guns were legal." Although satisfied that Rosenberger was in violation of 12280(b) PC, I decided to obtain added verification.

On 10-04-2001 at approximately 1630 hours, I was referred to Augie Rodriguez. Rodriguez is the California Department of Justice's "expert" in assault weapons, and has the title of Criminal Identification Specialist. I explained about the weapons seized from the Rosenberger home, and provided him with their make, model and serial numbers.

Of specific note was the Kimel Industries model AP9 that I recovered during the Search Warrant at the Rosenberger home. This weapon is a "copycat" of an Intertec Tec-9, but is not listed by brand name under 12276 PC. The weapon does however, fall within the banned assault weapons by definition under 12276.1 PC. I told Rodriguez that the weapon did show as being registered to Rosenberger in AFS, but it did not show as an "assault weapon." After checking the records via serial number, Rodriguez corrected me.

Rodriguez informed me that AFS had a "dealer's report of sale" (DROS) to Rosenberger for the Kimel, however, it WAS NOT registered as an assault weapon with the Department of Justice. Rodriguez told me this weapon was required to be registered based on its characteristics by 01-01-2001, pursuant to Senate Bill 23.

I read the serial number of the Norinco rifle to Rodriguez, giving him "84S403675." Rodriguez explained that the correct serial number was 403675. The preceding "84S" actually stood for the model. This particular weapon is in fact listed under 12276 PC by make and model, and Rodriguez said it was on an earlier banned list. This weapon (AK series or AK-47 copycat) was required to be registered as an assault weapon with the Department of Justice by 03-31-1992 as a category 1 weapon. Rodriguez checked and found that this weapon was not registered either. Additionally, all listed banned weapons not in the category list were required to be registered by 01-23-2001.

Lastly, Rodriguez checked the serial number of the Tommy Gun and found that it was not registered as an assault weapon with the Department of Justice. By characteristic, this weapon fell under 12276.1 PC and was required to be registered as an assault weapon by 01-01-2001, pursuant to Senate Bill 23.

I informed Rodriguez I would need a certified document attesting to the fact that none of the above three mentioned assault weapons were registered as assault weapons, yet they were required to be, in the event this case goes to trial. Rodriguez supplied me with the information to obtain such documentation and a letter of request was mailed.

APPROVED: SGT. DICK MILLER #062339

BY: DET. MARK RENFROW #274578

ASSIGNED: LENNOX DETECTIVE BUREAU

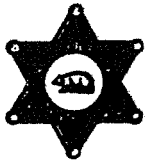

County of Los Angeles
Sheriff's Department Headquarters
4700 Ramona Boulevard
Monterey Park, California 91754-2169



LEROY D. BACA, SHERIFF

: 10-04-2001

California Department of Justice
Assault Weapons Registration
ATTN: May Wright
P.O. Box 903387
Sacramento, CA 94203-3870

Dear Agent Wright,

This letter is in response to a discussion of today's date between Detective Mark Renfrow and D.O.J. Criminal Identifications Specialist Augie Rodriguez. During this discussion, Detective Renfrow provided the serial numbers, brand names and models of three "assault weapons," which were checked in your records for registration. None of the weapons showed as registered.

Detective Renfrow is working a criminal case involving assault weapons and will need a certified document for trial from the Department of Justice, indicating these weapons have not been registered as "assault weapons," as required by the laws of the State of California.

The weapons in question are as follows:

1. Kimel Industries model AP9 (pistol and Tec-9 lookalike), 9mm, serial # 37286
2. Norinco model 84S (rifle), cal .223, serial # 403675
3. Thompson model 1927A (rifle), cal .45, serial # 22592

The person charged with violations of 12280(b) PC under Los Angeles Superior Court Case # YA048860 is Ludovic Rosenberger, D.O.B.: 01-12-1951.

If you require additional information, please contact Detective Mark L. Renfrow at (310) 680-5738, Wednesday through Saturday, between the hours of 5:00 P.M. and 3:00 A.M.. If possible, mail your response to the address listed below and fax a copy to (310) 677-7132 (ATTN: Detective Renfrow).

Thank you for your cooperation.

Sincerely,

LEROY D. BACA, SHERIFF

Sammy L. Jones, Captain
Lennox Sheriff's Station
4331 Lennox Blvd.
Inglewood, California 90304

cc:

Inglewood District Attorney's Office

A Tradition of Service

PAGE 01 10/04/01 16:15:12 LXPL PRINT REQUESTED BY TERMINAL LX0L
TO: LX0L FROM: CLETS 10/04/01 16:14:06
4AWMBLX0LR.IG
CA0190003 RE: QGB.CA0190003.SER/403675.CAL/2
RESPONSE TO QGB INQUIRY

RECORD IN AFS

CHECKING NCIC
END AFS RESPONSE.

*CORRECT SERIAL
NUMBER OF NOKING.*

PAGE 02

TO: LX0L FROM: NCIC

10/04/01 16:14:23

4AWMBLX0LR.IJ

1L01

CA0190003

RECORD SER/403675

COUNTY OF LOS ANGELES-SHERIFF'S DEPARTMENT-SUPPLEMENTARY REPORT**DATE:** 10-04-2001**FILE:** 401-08657-0372-151**C:** . Possession of an Assault Weapon, 12280(b) PC**ACTION:** ACTIVE/Additional Information**V:****S:** Rosenberger, Ludovic MW/01-12-1951 Booking # 6944-687**NARRATIVE**

In preparation for the preliminary hearing in the case of People vs. Ludovic Rosenberger, I decided to contact the California Department of Justice regarding all of the weapons seized from the Rosenberger home. This was in response to unsolicited comments from Rosenberger during the Search Warrant that "his attorney told him all of his guns were legal." Although satisfied that Rosenberger was in violation of 12280(b) PC, I decided to obtain added verification.

On 10-04-2001 at approximately 1630 hours, I was referred to Augie Rodriguez. Rodriguez is the California Department of Justice's "expert" in assault weapons, and has the title of Criminal Identification Specialist. I explained about the weapons seized from the Rosenberger home, and provided him with their make, model and serial numbers.

Of specific note was the Kimel Industries model AP9 that I recovered during the Search Warrant at the Rosenberger home. This weapon is a "copycat" of an Intertec Tec-9, but is not listed by brand name under 12276 PC. The weapon does however, fall within the banned assault weapons by definition under 12276.1 PC. I told Rodriguez that the weapon did show as being registered to Rosenberger in AFS, but it did not show as an "assault weapon." After checking the records via serial number, Rodriguez corrected me.

Rodriguez informed me that AFS had a "dealer's report of sale" (DROS) to Rosenberger for the Kimel, however, it WAS NOT registered as an assault weapon with the Department of Justice. Rodriguez told me this weapon was required to be registered based on its characteristics by 01-01-2001, pursuant to Senate Bill 23.

I read the serial number of the Norinco rifle to Rodriguez, giving him "84S403675." Rodriguez explained that the correct serial number was 403675. The preceding "84S" actually stood for the model. This particular weapon is in fact listed under 12276 PC by make and model, and Rodriguez said it was on an earlier banned list. This weapon (AK series or AK-47 copycat) was required to be registered as an assault weapon with the Department of Justice by 03-31-1992 as a category 1 weapon. Rodriguez checked and found that this weapon was not registered either. Additionally, all listed banned weapons not in the category list were required to be registered by 01-23-2001.

Lastly, Rodriguez checked the serial number of the Tommy Gun and found that it was not registered as an assault weapon with the Department of Justice. By characteristic, this weapon fell under 12276.1 PC and was required to be registered as an assault weapon by 01-01-2001, pursuant to Senate Bill 23.

I informed Rodriguez I would need a certified document attesting to the fact that none of the above three mentioned assault weapons were registered as assault weapons, yet they were required to be, in the event this case goes to trial. Rodriguez supplied me with the information to obtain such documentation and a letter of request was mailed.

APPROVED: SGT. DICK MILLER #062339

BY: DET. MARK RENFROW #274578

ASSIGNED: LENNOX DETECTIVE BUREAU



County of Los Angeles
Sheriff's Department Headquarters
4700 Ramona Boulevard
Monterey Park, California 91754-2169



LEROY D. BACA, SHERIFF

10-04-2001

California Department of Justice
Assault Weapons Registration
ATTN: May Wright
P.O. Box 903387
Sacramento, CA 94203-3870

Dear Agent Wright,

This letter is in response to a discussion of today's date between Detective Mark Renfrow and D.O.J. Criminal Identifications Specialist Augie Rodriguez. During this discussion, Detective Renfrow provided the serial numbers, brand names and models of three "assault weapons," which were checked in your records for registration. None of the weapons showed as registered.

Detective Renfrow is working a criminal case involving assault weapons and will need a certified document for trial from the Department of Justice, indicating these weapons have not been registered as "assault weapons," as required by the laws of the State of California.

The weapons in question are as follows:

1. Kimel Industries model AP9 (pistol and Tec-9 lookalike), 9mm, serial # 37286
2. Norinco model 84S (rifle), cal .223, serial # 403675
3. Thompson model 1927A (rifle), cal .45, serial # 22592

The person charged with violations of 12280(b) PC under Los Angeles Superior Court Case # YA048860 is Ludovic Rosenberger, D.O.B.: 01-12-1951.

If you require additional information, please contact Detective Mark L. Renfrow at (310) 680-5738, Wednesday through Saturday, between the hours of 5:00 P.M. and 3:00 A.M.. If possible, mail your response to the address listed below and fax a copy to (310) 677-7132 (ATTN: Detective Renfrow).

Thank you for your cooperation.

Sincerely,

LEROY D. BACA, SHERIFF

Sammy L. Jones, Captain
Lennox Sheriff's Station
4331 Lennox Blvd.
Inglewood, California 90304

cc:
Inglewood District Attorney's Office

A Tradition of Service

PAGE 01 10/04/01 16:15:12 LXPL PRINT REQUESTED BY TERMINAL LX0L
TO: LX0L FROM: CLETS 10/04/01 16:14:06
4AWMBLX0LR.IG
CA0190003 RE: QGB.CA0190003.SER/403675.CAL/2
RESPONSE TO QGB INQUIRY

RECORD IN AFS

CHECKING NCIC
END AFS RESPONSE.

*Correct Serial
Number of Name.*

PAGE 02
TO: LX0L FROM: NCIC
4AWMBLX0LR.IJ
1L01
CA0190003

10/04/01 16:14:23

RECORD SER/403675

10-403675-1

TURNER'S OUTDOORSMAN



ALEX

121004

- SIGNAL HILL
2201 E. Willow (310) 424-8628
- RESEDA
19329 Vanowen St. (818) 996-5033
- ORANGE
1932 N. Tustin Ave. (714) 974-0800
- WEST COVINA
1214 W. Francisquito (818) 917-8368

- STANTON
12775 Beach Blvd. (714) 379-3191
- RIVERSIDE
10190 Indiana Ave. (909) 351-1190
- NORWALK
11336 Firestone Bl. (310) 929-4056
- FOUNTAIN VALLEY
18808 Brookhurst (714) 965-5151

- CHINO OUTLET
12615 Colony St. (909) 590-7225
- PASADENA
800 So. Arroyo Parkway (818) 578-0155
- LAWDALE
16325 Hawthorne Bl. (310) 214-8724
- SAN BERNARDINO
491 W. Orange Show Rd. (909) 388-1090

LAYAWAY AGREEMENT

NAME LU DOVITC ROSENBERGER DATE 9-29-93
 ADDRESS 1441 W. 103RD ST.
 CITY LOS ANGELES STATE CA ZIP 90047 PHONE NO. (213) 755-6406

SOLD BY	DEPOSIT	CREDIT CARD	CHECK	CASH	SKU #	V.P.C. #	P.U. DATE	4473 #	4473 DATE
LEO	\$ FULL				487925	AP9N	10-15-93	1140622	10-18-93
QUANTITY	DESCRIPTION		PRICE	AMOUNT					
1	1	KIMEL AP-9 9mm 5" NICKEL		249.99					
	2			20.62					
	3			270.61					
S/N	037286								
C.D.L.	N8491304 1-97								
D.O.B.	1-12-51								
D.R.O.S.#	P482579 REG FEE (17.86) (NON REFUNDABLE)								
TIME	14:27								

TERMS AND CONDITIONS

Purchaser hereby agrees to purchase of the following:

AS NOTED ABOVE

For the consideration of FULL (SPECIFIC DESCRIPTION OF GOODS)
 Seller agrees to hold the above-described goods on layaway for Purchaser until
11-29-93 (AMOUNT OF DEPOSIT) (DATE FINAL PAYMENT DUE)
 The total purchase price of \$ 270.61 includes
\$ 30.00 (HANDLING AND/OR PROCESSING CHARGES) (TOTAL PURCHASE PRICE)
 in handling and/or processing charges. The purchaser further agrees to the following terms of sale:

- 1) All gun sales on layaways are final. There will be no refunds or exchanges.
- 2) Any and all money, including any deposits applied to a layaway purchase, will be forfeited if the total purchase for the goods is not paid by the specified time above. However, Seller will refund any layaway deposits or subsequent payments, if any, it, before the end of the date final payment is due, the goods have for any reason become no longer available in the same condition as they were at the time of sale.
- 3) No express warranties are given by Seller and no affirmation of Seller, by words or action, shall constitute a warranty. The entire risk as to the quality and performance of the goods rests with the Purchaser. Should the goods prove defective following their purchase, the Purchaser and not the Seller assumes the entire cost of all necessary servicing or repair.

AGREED: [Signature]
 (SIGNATURE OF PURCHASER)

09-29-1993
 (DATE)

TURNER'S OUTDOORSMAN



79019

- SIGNAL HILL
2201 E Willow (310) 424-8628
- RESEDA
19329 Vanowen St. (818) 996-5033
- ORANGE
1932 N. Tustin Ave. (714) 974-0600
- WEST COVINA
1214 W. Francisquito (818) 917-8368

- ANAHEIM
1221 Knott Ave. (714) 761-2811
- RIVERSIDE
10190 Indiana Ave. (909) 351-1190
- NORWALK
11336 Firestone E (310) 929-4056

- FOUNTAIN VALLEY
18808 Brookhurst (714) 965-5151
- CHINO OUTLET
12615 Colony St. (909) 590-7225
- PASADENA
800 So. Arroyo Parkway (818) 578-0155
- LAWDALE
16325 Hawthorne Bl. (310) 214-8724

LAYAWAY AGREEMENT

NAME LUDWIG ROSENBERGER DATE 1-2-93
 ADDRESS 1441 W 103RD STREET
 CITY COS ANGELES STATE California ZIP 90047 PHONE NO. 213-755-6426

SOLD BY	DEPOSIT	CREDIT CARD	CHECK	CASH	SKU #	V.P.C. #	P.U. DATE	4473 #	4473 DATE
DAN	\$				102887	TL	4-18-93	11-1000	5-3-93
QUANTITY	DESCRIPTION		PRICE	AMOUNT					
1	AUTO ORDINANCE			579.99					
2	THO MPSON (45ACP)		Tax	49.50					
S/N 82592			Total		649.49				
C.D.L. N 8491304 1-91			mb4200						
D.O.B. 1-12-51									
D.R.O.S. # AB003130			NON REFUNDABLE						
TIME 3:36 PM			(\$17.86) mb4200						

TERMS AND CONDITIONS

Purchaser hereby agrees to purchase of the following:

AS NOTED ABOVE

For the consideration of 649.49 (AMOUNT OF DEPOSIT) Seller agrees to hold the above-described goods on layaway for Purchaser until 6-2-93 (DATE FINAL PAYMENT DUE). The total purchase price of \$ 649.49 (TOTAL PURCHASE PRICE) includes 30.00 (HANDLING AND/OR PROCESSING CHARGES) in handling and/or processing charges. The purchaser further agrees to the following terms of sale:

- All gun sales on layaways are final. There will be no refunds or exchanges.
- Any and all money, including any deposits applied to a layaway purchase, will be forfeited if the total purchase for the goods is not paid by the specified time above. However, Seller will refund any layaway deposits or subsequent payments, if any, if, before the end of the date final payment is due, the goods have for any reason become no longer available in the same condition as they were at the time of sale. No express warranties are given by Seller and no affirmation of Seller, by words or action, shall constitute a warranty. The entire risk as to the quality and performance of the goods rests with the Purchaser. Should the goods prove defective following their purchase, the Purchaser and not the Seller assumes the entire cost of all necessary servicing or repair.

PAID
mb4200

AGREED: Ludwig Rosenberg
(SIGNATURE OF PURCHASER)

04-02-1993
(DATE)

TO: LX0H FROM: CLETS

08/09/01 20:49:58

4AWLXLX0HR.IG

CA0190003 RE: SER/425PP03606

RESPONSE TO QGB INQUIRY

DATA IN AFS.

* EVIDENCE

SER/425PP03606 MAK/BRO BROWNING CAL/380 MOD/BDA

TYP/P PISTOL CAT/I SEMI-AUTOMATIC DOT/20010809

ORI/CA0190003 OCA/010865703

FCN/2320122101455 DOP/32011

REFER DETECTIVE RENFROW #274578

FILE #401-08657-0372-151

LAB RECEIPT
J192970

TO: LX0H FROM: CLETS 08/09/01 20:52:03
4AWLXLX0HU.IG LAPH PRINT REQUESTED BY TERMINAL LX0H

CA0190003 RE: SER/37286
RESPONSE TO QGB INQUIRY

DATA IN AFS.

* EVIDENCE

SER/37286 MAK/KIM KIMEL/KIMEL IND. CAL/9 MOD/AP9
TYP/P PISTOL CAT/I SEMI-AUTOMATIC BBL/5 DOT/20010809
ORI/CA0190003 OCA/010865703
FCN/2320122101457 DOP/32011

REFER DETECTIVE RENFROW #274578
FILE #401-08657-0372-151

LAB RECEIPT
J192971

08/09/01 21:13:53 LXPB PRINT REQUESTED BY TERMINAL LX0H
TO: LX0H FROM: CLETS 08/09/01 21:13:23
4AWLXLX0HZ.IG

CA0190003 RE: SER/L2109353
RESPONSE TO QGB INQUIRY

DATA IN AFS.

* EVIDENCE

SER/L2109353 MAK/WIN WINCHESTER CAL/12 MOD/STAINLESS MARINE
TYP/S SHOTGUN CAT/P PUMP ACTION DOT/20010809
ORI/CA0190003 OCA/010865703
FCN/2320122101469 DOP/32011

REFER DETECTIVE RENFROW #274578
FILE #401-08657-0372-151

LAB RECEIPT
J192972

PAGE 01 08/09/01 21:39:56 LXPH PRINT REQUESTED BY TERMINAL LX0H

TO: LX0H FROM: CLETS

08/09/01 21:39:10

PAGE 01

4AWLXLX0HC.IG

CA0190003 RE: SER/HU411

RESPONSE TO QGB INQUIRY

DATA IN AFS.

* EVIDENCE

SER/HU411 MAK/US UNITED STATES CAL/762 MOD/M44 MOSIN NAGANT

TYP/R RIFLE CAT/B BOLT ACTION DOT/20010809

ORI/CA0190003 OCA/010865703 MIS/HAS BAYONET AFFIXED

FCN/2320122101474 DOP/32011

REFER DETECTIVE RENFROW #274578

FILE #401-08657-0372-151

*LAB RECEIPT
#J192973*



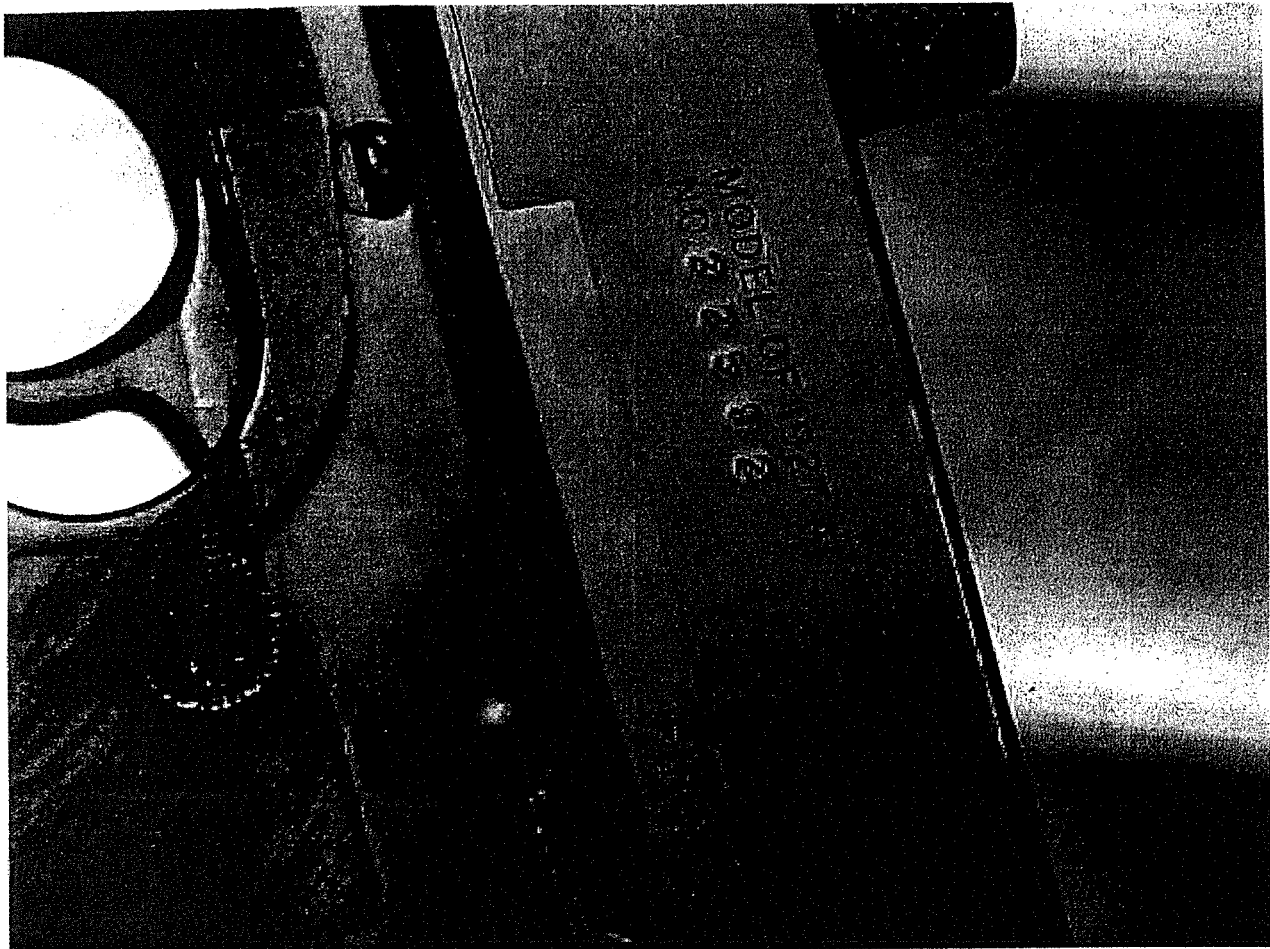
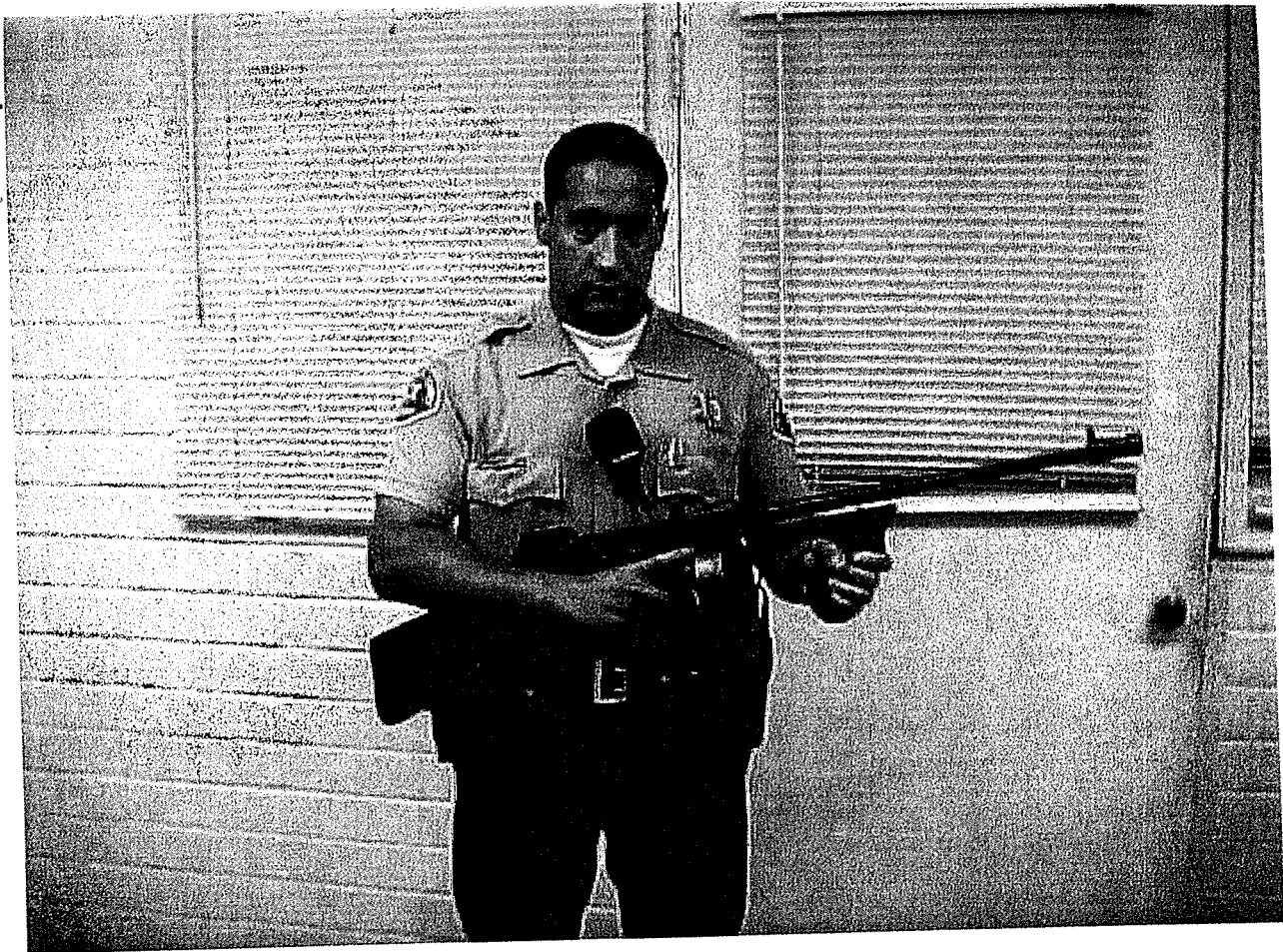

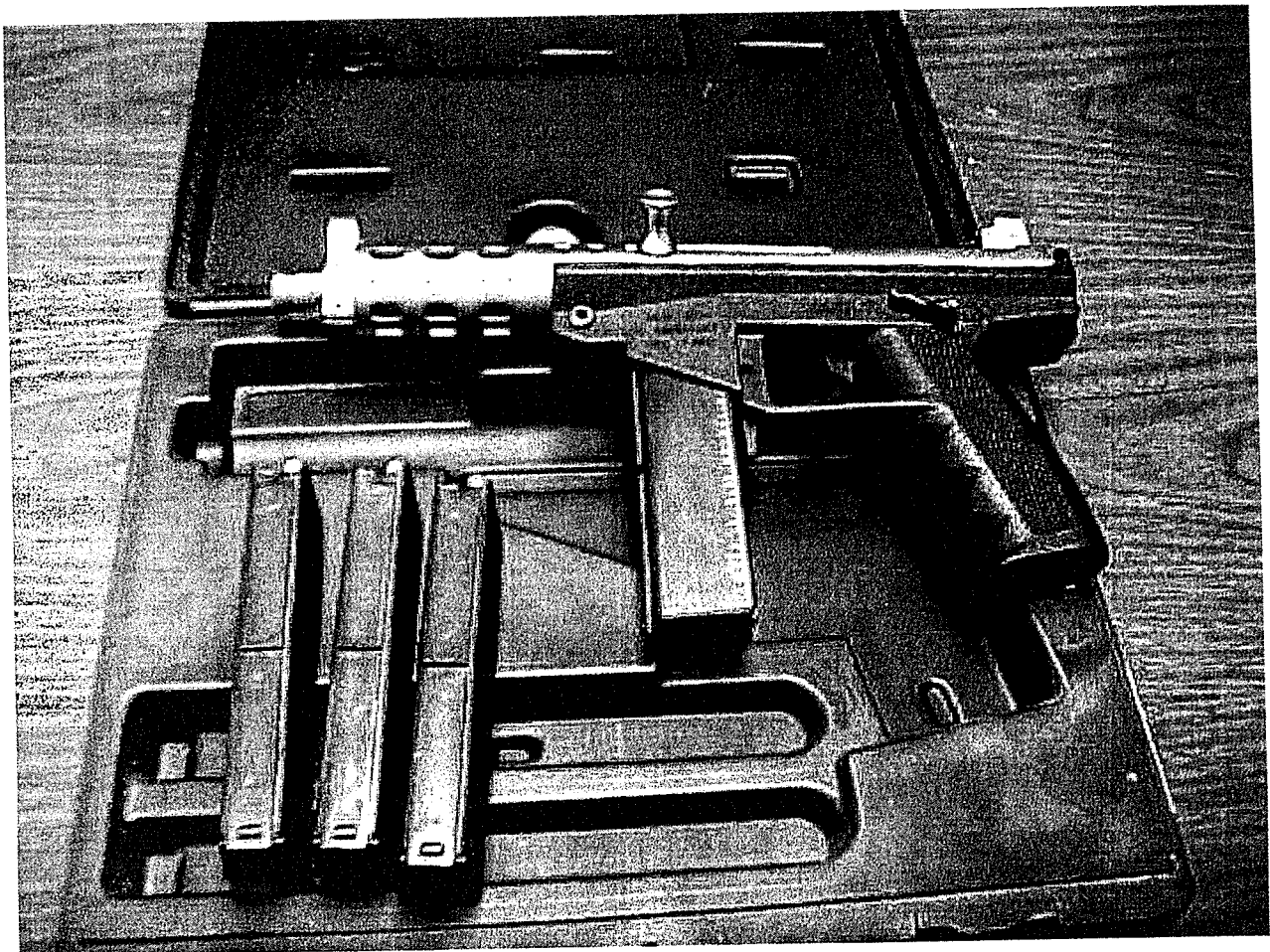

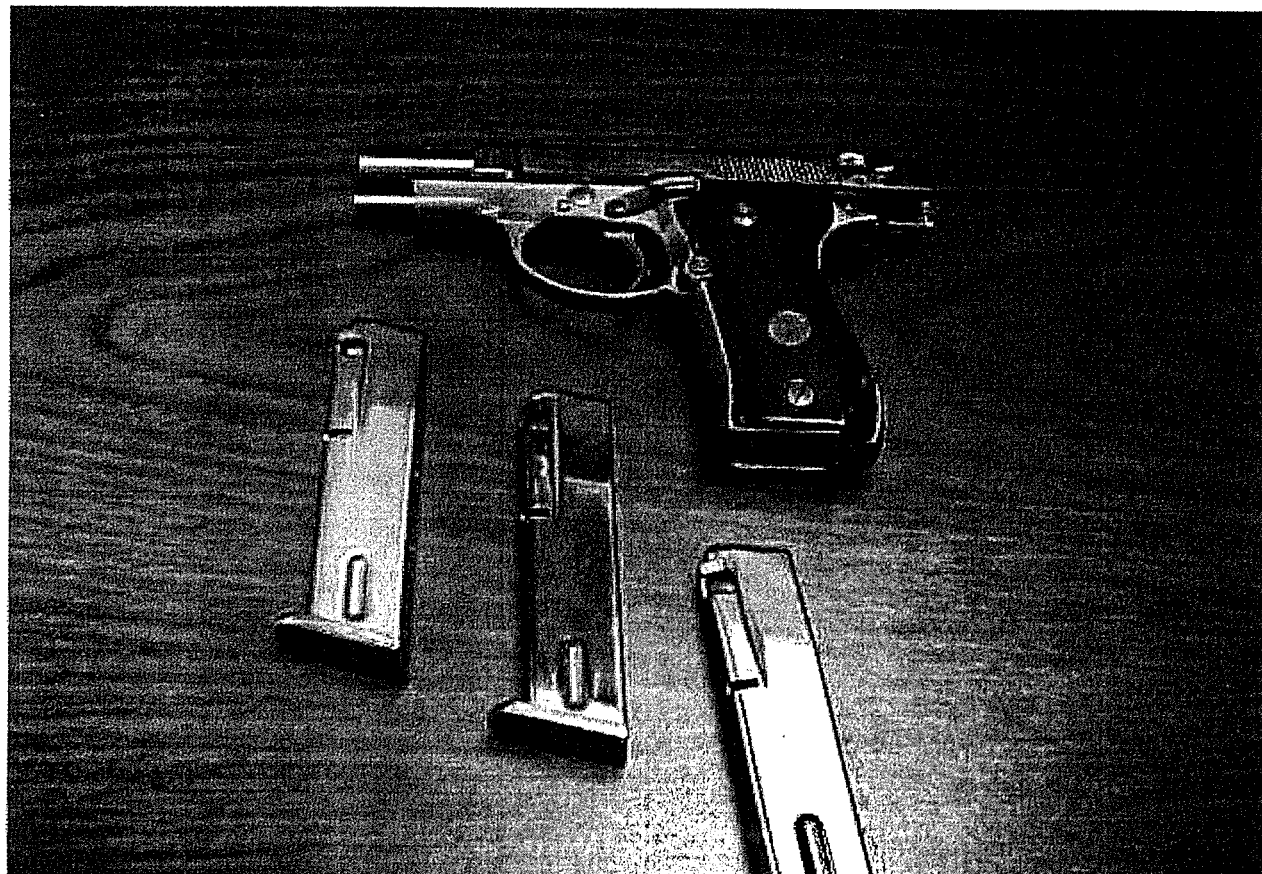

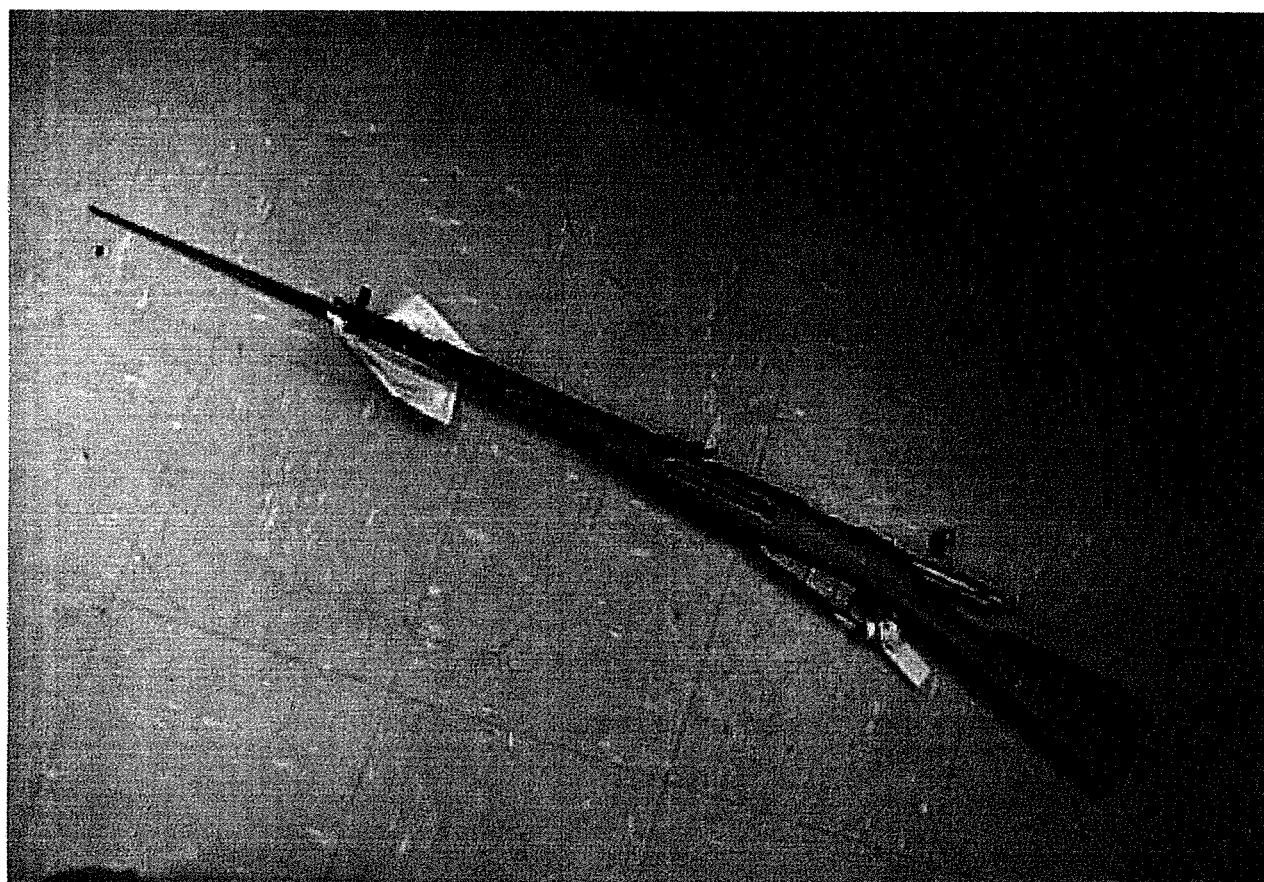
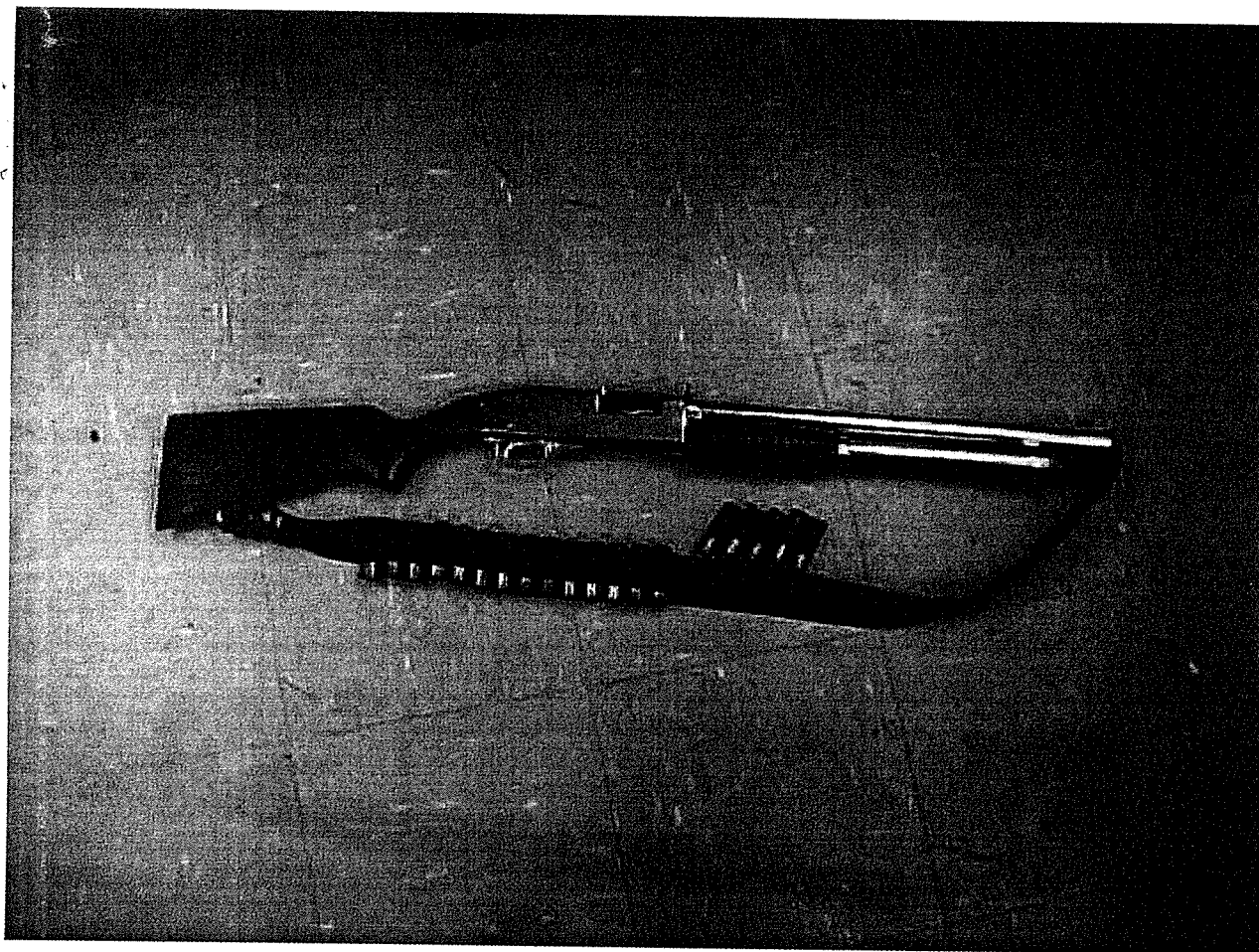

The Law Offices of
BARRY O. BERNSTEIN, INC.

*-Exclusively Criminal Defense-
California, Federal & Military*

3727 W. Magnolia Boulevard, #767, Burbank, California 91510
Telephone (818) 558-1717 - Facsimile (818) 526-7672

Barry O. Bernstein, Trial Attorney

Of Counsel

Karyn H. Bucur, Attorney

Certified Appellate Law Specialist

Jeffrey E. Karpel, Attorney

Civil and Torts

Brian D. Lerner, Attorney

Certified Immigration & Nationality Law Specialist

April 02, 2002

Chuck Michele, Attorney
407 N. Harbor Blvd.,
San Pedro, California 90731

RE: People v. Ludovic Rosenberger

Dear Mr. Michele:

Thank you for discussing this matter with my assistant this afternoon. As indicated, I have a trial date currently set for April 8, 2002 and need an expert. Please advise me whether you think you can assist. Thank you.

Enclosed please find the following:

- Felony Complaint,
- Preliminary Hearing Transcript,
- Our Motion to Dismiss and Supplementary Motion
- Incident Reports and Addendum to Incident Reports,
- Property Reports

Should you have any additional questions regarding this matter, please feel free to contact me.

Very truly yours,



Barry O. Bernstein, Attorney
Law Offices of Barry O. Bernstein

Encl.

12th EDITION

Auto-Ordnance Corporation

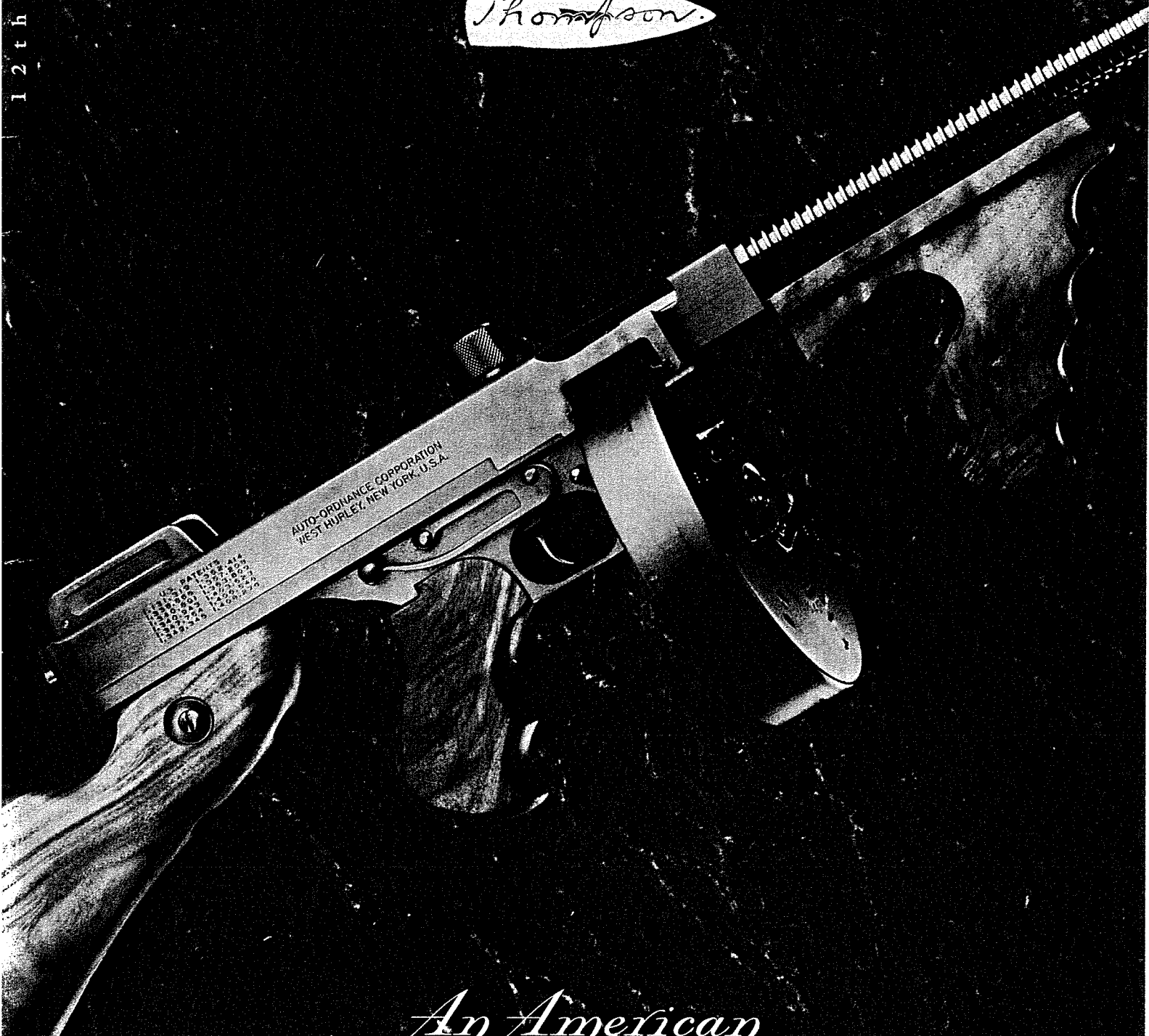
Thompson.



AUTO-ORDNANCE CORPORATION
WEST HURLEY, NEW YORK, U.S.A.

*An American
Tradition
Since 1916*

FOWLER GUN ROOM
BUY • SELL • TRADE
(714) 771-5738
258 So. Tustin - Orange, CA 92666
10:00 AM to 7:00 PM SAT 10:00 to 5:00 PM SUN 10:00 AM to 5:00 PM

Made in America

**With a Tradition of
Excellence**



Thompson.

**And a Dedication
to Quality.**

Auto-Ordnance Corporation

W. Hurley, NY 12491 Tel: (914) 679-7225 FAX: (914) 679-2698

THOMPSON 1927A-1

"Deluxe Semi-Auto"

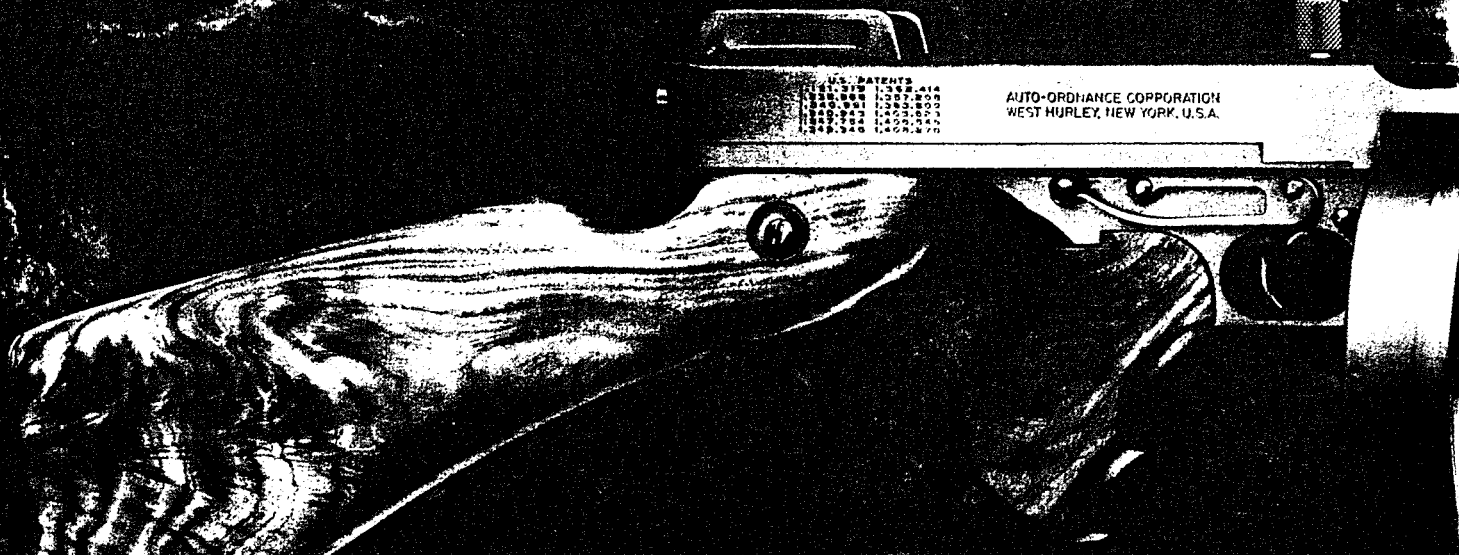

Caliber:45 ACP
Barrel:16 1/2", Finned & Threaded
(with compensator 18")
Weight:13 lbs.
Length:41" overall
Sight:Blade front, open rear adjustable
Stock:Walnut fixed stock, vertical foregrip
Magazine:30 Shot stick*

**Will accept 100 rd., 50 rd., and 10 rd. drum magazines -
Drum magazines sold separately on page 15.*

THOMPSON 1927A-1C

"Lightweight Semi-Auto"

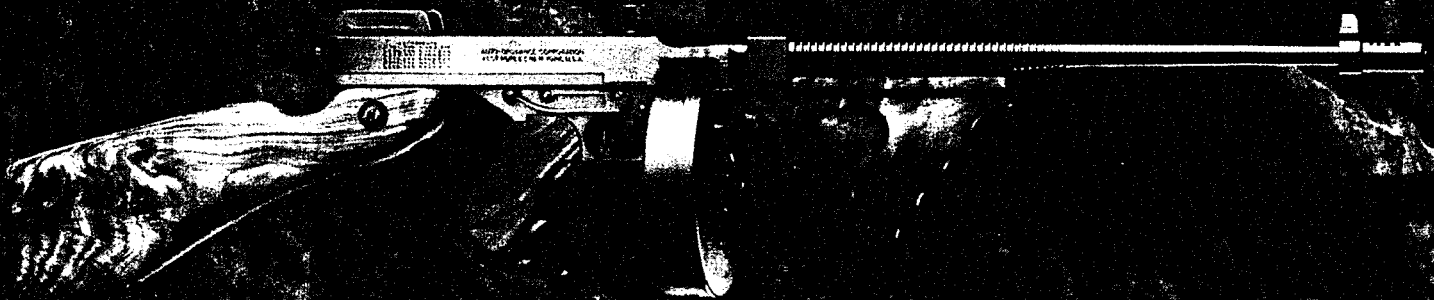

This very popular version of the .45 caliber Deluxe is identical in appearance but 25% less in weight. As you would expect, this model is durably manufactured in a light-weight alloy and offers the same reliable performance and attractive features as our all steel version.

Caliber:45 ACP
Barrel:16 1/2", Finned & Threaded
(with compensator 18")
Weight:9 1/2 lbs.
Length:41" overall
Sight:Blade front, open rear adjustable
Stock:Walnut fixed stock, vertical foregrip
Magazine:30 Shot stick*

AUTO-ORDNANCE CORPORATION

Thompson.

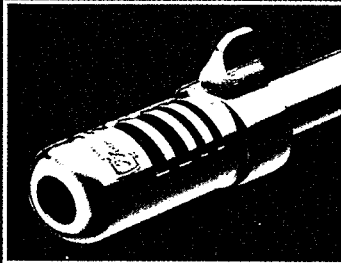

Compensator for reduced recoil.

All the classic details of the time honored original are reproduced in today's semi-auto Thompson. With the frame and receiver still machined from solid milled steel and all

wood handsomely finished genuine walnut makes this our most desired model. This .45 caliber carbine features 16 1/2" finned barrel, compensator and finished in a rich blue.

THOMPSON M1
"Semi-Automatic"



Caliber:45 ACP
Barrel:.....16 1/2", Smooth
Weight:.....11 1/2 lbs.
Length:.....38" overall
Sight:.....Blade front, fixed battle rear
Stock:..Walnut fixed stock and horizontal foregrip
Magazine:.....30 Shot stick*

*Will not accept drum magazines.

Here is a .45 caliber semi-automatic version of the world's first and most famous military rifle. The Thompson M1 was used victoriously in battles throughout the world, inscribing its place for all times as a legend among military firearms. We offer the same attention to crafts-

manship today that made the original so highly regarded. The look and feel are authentic, right down to the side bolt action. The frame and receiver are milled from solid steel, the wood is genuine walnut and the overall finish is a rich blue..

the
THOMPSON



THE
MILITARY
BOOK CLUB ★★

CHRIS ELLIS

CLASSIC WEAPONS SERIES

the

THOMPSON



THE
MILITARY
BOOK CLUB ★★

RIGHT: Sketch of the Cutts Compensator showing the later production type.

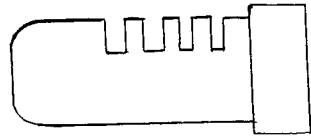

BELOW: Production M1928 for the US Army order of 1938, showing sling swivels, Cutts Compensator and early pattern 30-round box magazine with counting holes. This was later designated M1928A1.

Later variations

Several changes were made to the Thompson SMG between the two world wars. The original M1921, subsequently called M1921A when supplied in standard form, was sold unaltered for some years and the first 3,000 sales were of this type.

Model 1923 Military Thompson

In a further attempt to attract military sales, five M1921 guns were modified to fire the slightly longer .45in Remington round. Apart from rechambering for the new round, this version had a longer barrel with a fitting near the muzzle which could either take a folding bipod or a bayonet. The butt was bulked up, and a grooved front grip replaced the front hand grip. The idea was to turn the weapon into a squad light machine gun. It was demonstrated to a few military authorities and tested by the US Army in 1924, but no orders were forthcoming. Two further guns were modified with the same longer (16in/41cm) barrel and rechambering, but this time without the bipod fitting or the horizontal grooved handgrip—the pistol grip was retained. There was possibly the idea of police sales for this more powerful version, but none were made.

The Model 1923 Military Thompson was also offered with sling swivels for a

sling to meet military requirements. Subsequently this was an option on all models, the suffix S being applied to models so fitted.

Model 1921AC

Col Richard Cutts purchased his own M1921 Thompson and found one weakness of the gun in the hands of an inexperienced firer. With the first shot the muzzle jumped on recoil, and in full automatic it jumped again in rapid succession after every round, faster than the gunner could counter by forcing the muzzle down again. This meant that the gun tended to fire with a rising pattern. Cutts' first attempt to cure this was to fit a counterweight on the muzzle, but this had little effect. A physicist friend studied the problem and suggested an expansion chamber and tube at the muzzle to reduce the recoil by dispersing some of the propellant gases. The slotted unit was simply pushed onto the muzzle in front of the foresight and held in place by a tightened screw. The device was known as the Cutts Compensator and was sold from 1926 as an optional extra, adding \$25 to the price. Cutts got a royalty on sales, and the Lyman Gun Sight Corp made it. Many were retrofitted to existing guns. Over the years the Cutts Compensator was itself modified slightly, with the final types fitted on World War 2 guns. There were actually five variants with dimensional differences. The suffix C was subsequently added to all model numbers when the Cutts Compensator was fitted.

Model 1927 Thompson Semi-automatic Carbine

This was also called the Thompson Automatic Carbine Model 27A in Auto-Ordnance catalogues of the time. It was a Model 1921 gun modified to remove the automatic fire selector function so that the gun could only fire in semi-automatic mode (ie, single shots)—hence it was no longer a submachine gun. It was available with or without the Cutts Compensator or sling swivels, and another options was the grooved horizontal foregrip in place of the

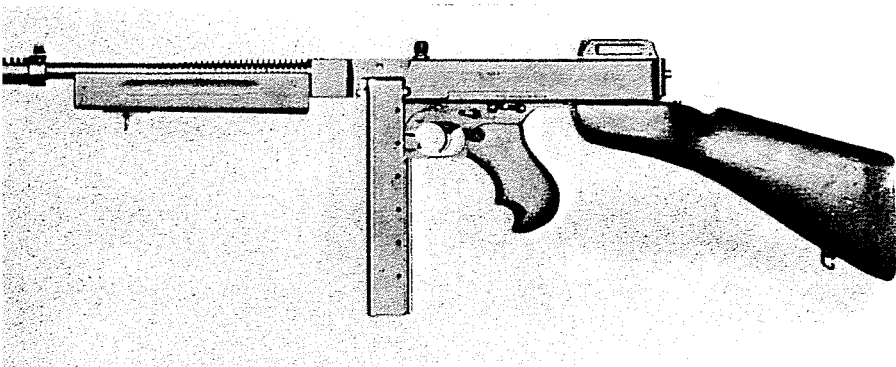

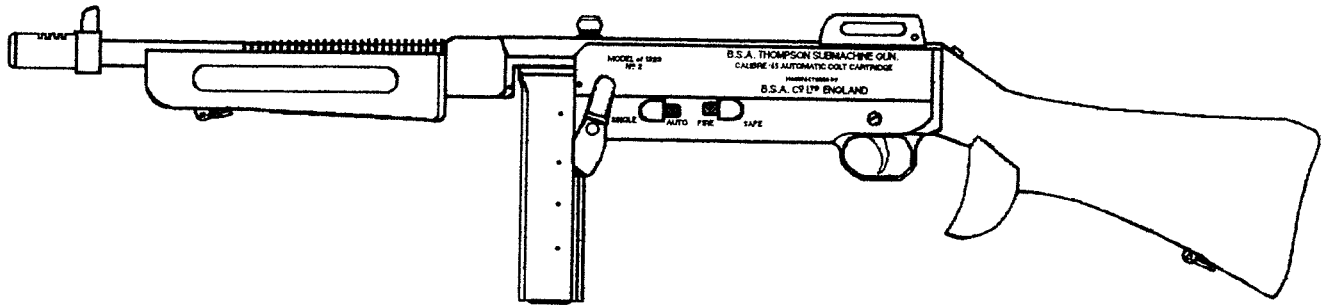

vertical foregrip, this fitting being seemingly derived from the Model 1923. Guns with this feature were described as 'Special Grade' with an S suffix in place of the A—thus Model 27S. A further option offered was the 50-round drum magazine and the suffix D was added to the designation when this was supplied fitted. So it was possible to have a Model 27SCDS indicating: S—a Model 1927 carbine special grade (with horizontal foregrip), C—fitted with Cutts Compensator, D—50-round drum magazine and S—sling swivels.

The 27S was priced more highly than the 27A. On the Model 1927 the original Model 1921 and Thompson Submachine Gun lettering had been ground off the frame and model of 1927) and 'Thompson Semi-automatic Carbine' lettering stamped in its place. This weapon was offered to police forces and prison authorities who did not require the automatic fire facility. Some of these weapons were retrospectively converted back to fully automatic fire function—either officially or otherwise.

Model 1926 BSA Thompson

The Belgian Army had showed great interest in the Thompson SMG on General Thompson's original European tour and carried out field trials in 1923. The Belgians wanted to standardise ammunition on the 9mm Parabellum round, however, and wanted a rifle-style stock and sling. Leading British gun firm BSA (Birmingham Small Arms) had been given the licence for European Thompson sales and Auto-Ordnance asked BSA to remodel

the gun for the Belgian requirement. While the frame, box magazine and firing mechanism were all unchanged, the resulting weapon had a plain finless barrel and rifle-style butt and furniture. This was tested by both the French and Belgian armies but in the event no orders were forthcoming, even though the Belgians had mentioned a requirement for 10,000.

Additionally, the French army did not consider the BSA Thompson superior to any available French weapon of similar type.

Model 1929 BSA Thompson

BSA persisted in an attempt to produce a version of the Thompson SMG for the European market. The Model 1929 more closely resembled the American-made models, having the finned barrel, frame, horizontal foregrip, box magazine and firing mechanism identical. However, the butt was of more 'British' shape and there was a conventional rifle-type trigger and trigger guard with a small handgrip behind it, said to improve steadiness when firing from the hip. Versions were produced chambered to take the .45in ACP round,

ABOVE: BSA Thompson of 1929, .45in calibre version.

BELOW: BSA Thompson of 1929, 9mm calibre version.

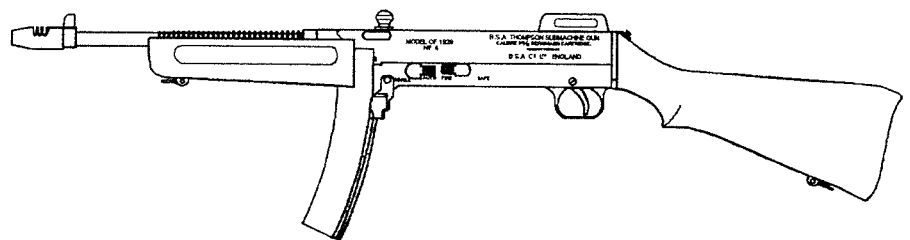

RIGHT: Cross-section through Thompson SMG Model 1928A1, from US Army TM.

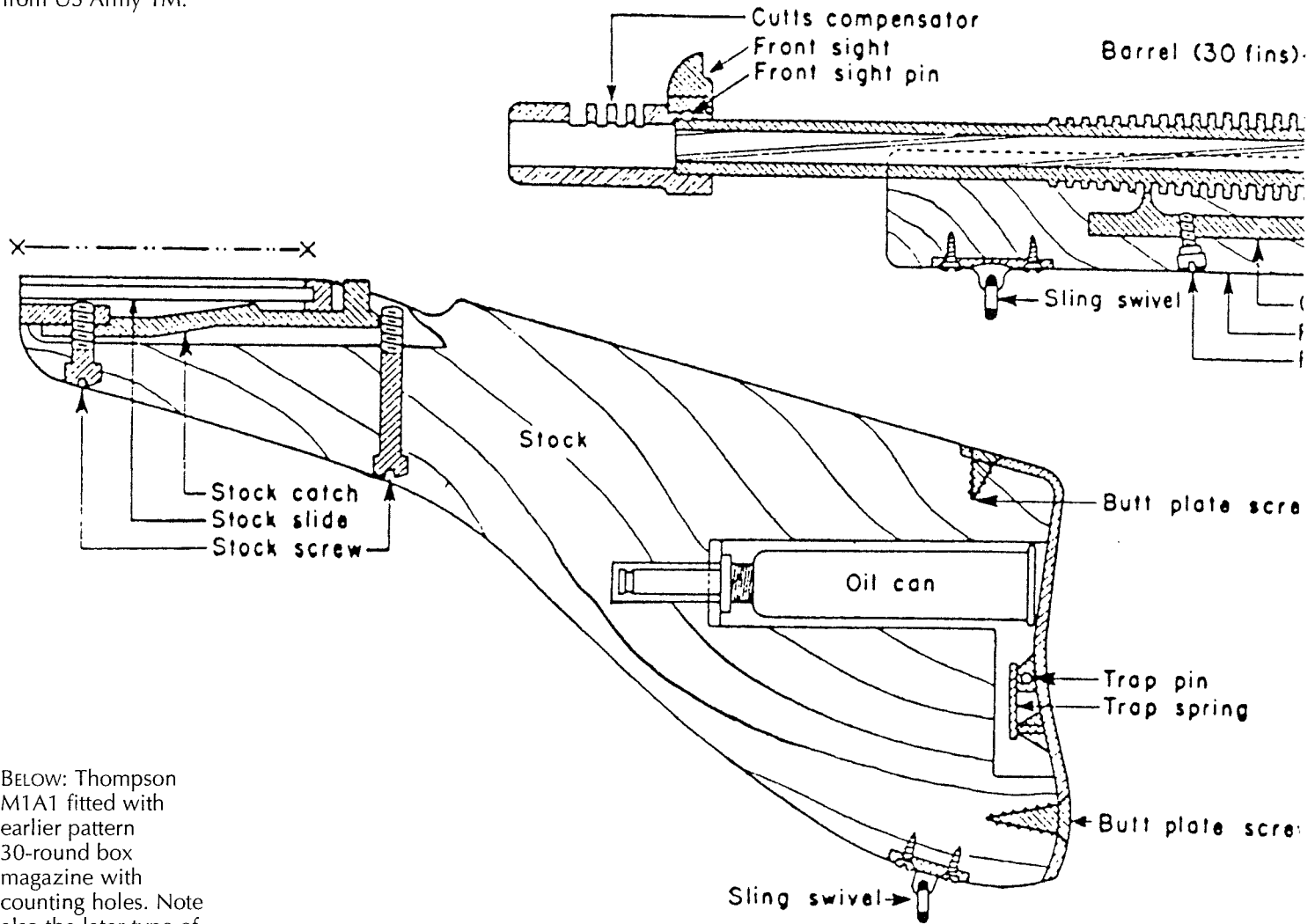

BELOW: Thompson M1A1 fitted with earlier pattern 30-round box magazine with counting holes. Note also the later type of simplified pressed metal backsight, reinforcing bolt through butt and pin-type safety/selector levers.

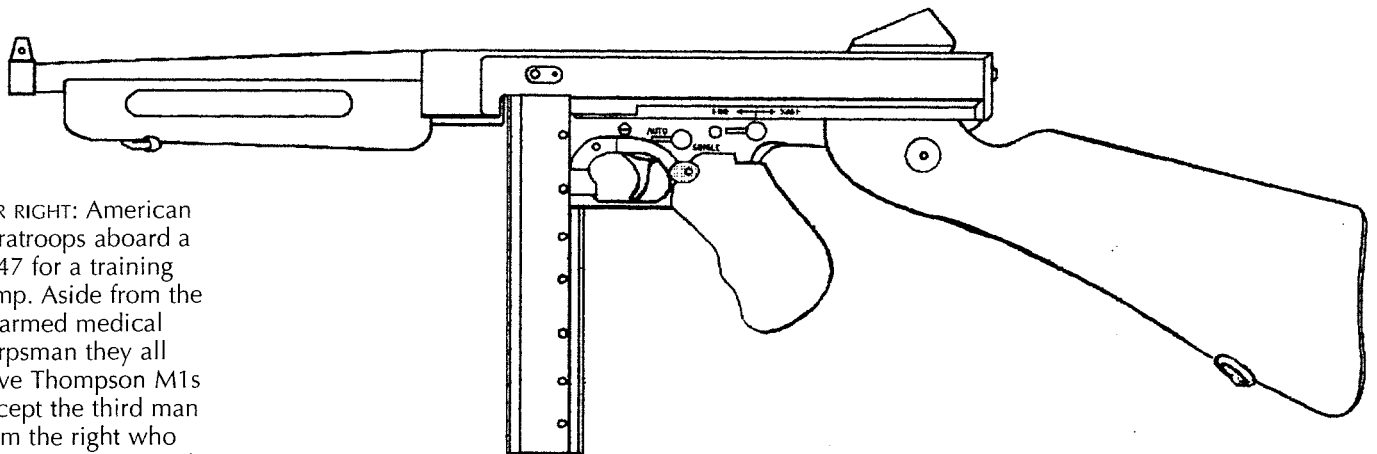

FAR RIGHT: American paratroops aboard a C-47 for a training jump. Aside from the unarmed medical corpsman they all have Thompson M1s except the third man from the right who has a M1928A1 with Cuts Compensator.

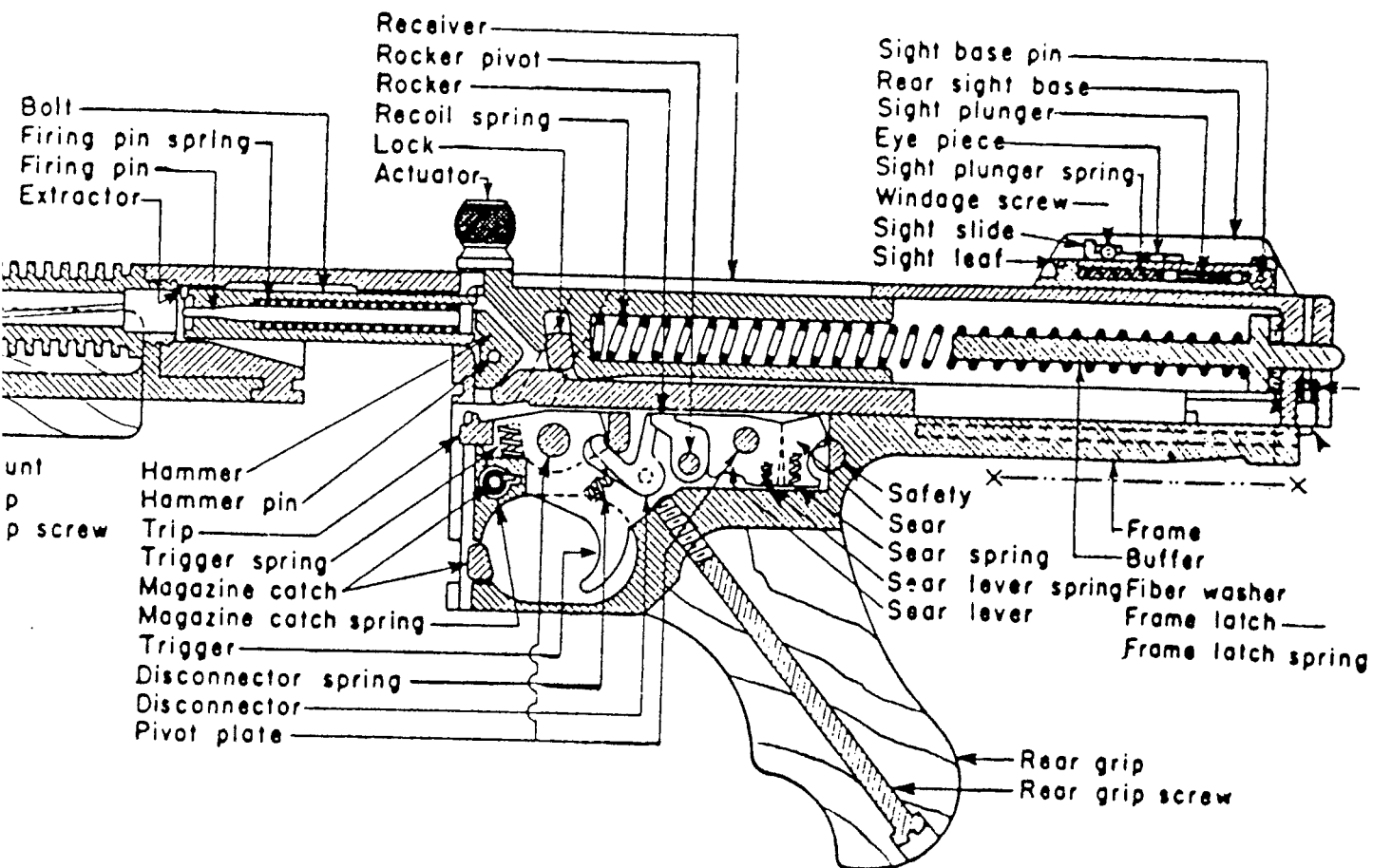



**DEPARTMENT OF THE ARMY
FRANKFORD ARSENAL
Philadelphia, Pa. 19137**

**SILENCERS
PRINCIPLES AND EVALUATIONS**

Patents - United States

<u>No.</u>	<u>Date</u>	<u>Inventor</u>	<u>Title</u>
1 482 805	5 Feb 24	H. P. Maxim	Silencer for Guns
1 487 214	18 Mar 24	R. L. Detendorf	Firearms & Ammunition Therefor
1 497 553	10 Jun 24	J. Dickman	Exhaust Silencer
1 525 846	10 Feb 25	L. E. Wurtzbach	Silencing Device for Firearms
1 554 051	15 Sep 25	O. Walker	Firearms
1 605 393	2 Nov 26	R. M. Cutts	Climb Arrester
1 605 864	2 Nov 26	R. Steinegger	Muzzle Attachment
1 636 357	19 Jul 27	Cutts	
1 667 186	24 Apr 28	W. R. Bluedorn	Muzzle Attachment for Guns
1 736 319	19 Nov 29	H. P. Maxim	Silencer
1 763 287	10 Jun 30	Z. Wilman	Damping Apparatus for Prevention of Noise, etc.
1 773 443	19 Aug 30	Z. Wilman	Silencer, etc.
1 874 326	30 Aug 32	W. P. Mason	Sound Muffler
1 939 700	19 Dec 33	C. F. Hopsetter	Muzzle Attachment for Guns
1 972 065	28 Aug 34	Q. G. Noblitt	Muffler
1 990 837	12 Feb 35	S. H. Morgenstern	Exhauster for Internal Combustion Engine
2 043 731	9 Jun 36	R. B. Bourne	Sound Attenuating Device
2 087 594	20 Jul 37	M. E. Evans	Projectile
2 101 849	14 Dec 37	S. G. Green	Muzzle Attachment for Guns
2 101 850	14 Dec 37	S. G. Green	Muzzle Attachment for Guns
2 112 831	5 Apr 38	R. M. Cutts	Compensation for Ordnance
2 128 936	6 Sep 38	S. G. Green	Muzzle Attachment for Guns
2 143 596	10 Jan 39	N. J. A. Galliot, etc.	Recoil Absorber for Firearms
2 150 161	14 Mar 39	S. G. Green	Muzzle Attachment for Guns
2 184 595	26 Dec 39	Hughes	Muzzle Attachment for Guns
2 194 484	27 Feb 40	Hughes	

Patents - United States

<u>No.</u>	<u>Date</u>	<u>Inventor</u>	<u>Title</u>
2 191 648	27 Feb 40	N. J. A. Galliot, etc.	Recoil Absorber for Firearms
2 208 093	16 Jul 40	J. L. Brown	Gun Silencer & Scavenger
2 212 685	27 Aug 40	R. H. S. Hughes	Control Device for Control of Recoil
2 212 686	27 Aug 40	R. H. S. Hughes	
2 216 653	1 Oct 40	J. Sauer	Suction Muffler
2 223 014	26 Nov 40	N. J. A. Galliot, etc	
2 233 804	4 Mar 41	R. B. Bourne	Fluid Silencer
2 241 768	13 May 41	F. E. Deremer	Silencer Construction
2 283 607	19 May 42	A. J. Ludwig	Muffler Device
2 348 114	2 May 44	A. M. Dow	Gun Stabilizer
2 351 037	13 Jun 44	S. G. Green	Stabilizer for Guns
2 375 617	8 May 45	R. B. Bourne	Gun Silencer
2 403 699	9 Jul 46	E. E. Wilson	Resonator Silencer
2 442 773	8 Jun 48	W. P. Mason	Sound Suppressor
2 448 382	31 Aug 48	W. P. Mason	Silencer
2 449 571	21 Sep 48	B. Walker	Silencer for Firearms
2 451 514	19 Oct 48	J. E. Sieg	Compensator for Guns
2 457 802	4 Jan 49	A. Bauer	Silencer & Recoil Reducer, etc.
2 501 306	21 Mar 50	P. E. Bessiere	Silencer with Flat Semicylindrical Expansion Chamber
2 503 491	11 Apr 50	R. Janz	Gun Silencer Including Side Branch Chamber
2 514 996	11 Jul 50	C. H. Faust	Flash Eliminator & Silencer for Firearms
2 625 235	13 Jan 53	C. P. Caulkins	Discharge Silencer & Recoil Compensator
2 868 078	13 Jan 59	W. J. Jarrett	Noise Reducer for Gun
3 134 330	26 May 64	B. Batou	Projectile
3 138 991	30 Jun 64	R. L. Malter	Firearm Muzzle Attachment & Projectile

2005 Standard Catalog of®

FIREARMS

THE COLLECTOR'S PRICE & REFERENCE GUIDE

15TH EDITION

From the publishers of
GunList



**7,000
photos**

NED SCHWING

- More than 110,000 accurate prices
- Prices for up to six grades of condition
- Details on 25,000 models

Thompson 1911 A1—Duo Tone

Chambered for the .45 ACP, the slide is blued and the frame is satin nickel. Discontinued in 1997.

NIB	Exc.	V.G.	Good	Fair	Poor
400	325	275	225	150	100

Thompson 1911 A—Satin Nickel

Chambered for .45 ACP or .38 Super the finish is a satin nickel on both frame and slide. Blade front sight and black checkered plastic grips. Discontinued in 1997.

NIB	Exc.	V.G.	Good	Fair	Poor
400	325	275	225	150	100

Thompson 1911 A1—Competition

Chambered for .45 ACP or .38 Super the pistol is fitted with a 5" barrel with compensator and other competition features such as custom Commander hammer, flat mainspring housing, beavertail grip safety, full length recoil guide rod, extended ejector, slide stop and thumb safety. Pistol weighs 42 oz. and is 10" overall. Discontinued in 1997.

NIB	Exc.	V.G.	Good	Fair	Poor
600	525	400	350	300	150

NOTE: For .38 Super add \$10 to above prices.

Thompson 1911 A1—Parkerized

NIB	Exc.	V.G.	Good	Fair	Poor
375	295	250	225	200	150

Thompson 1911 A1—Pit Bull

Chambered for .45 ACP and fitted with a 3-1/2" barrel this model has high profile sights and black textured rubber wrap-around grips. Magazine capacity is 7 rounds and weight is 36 oz.

NIB	Exc.	V.G.	Good	Fair	Poor
400	350	300	250	200	150

Thompson 1911 A1—General

This is a Commander-size pistol with 4-1/2" barrel, high profile sights. Chambered for .45 ACP or .38 Super. Weighs 37 oz. Discontinued in 1997.

NIB	Exc.	V.G.	Good	Fair	Poor
400	325	275	225	150	100

ZG-51 "Pit Bull"

Same as above, with a 3.5" barrel in .45 caliber. Introduced in 1988 and renamed "PIT BULL" in 1994. Discontinued.



NIB	Exc.	V.G.	Good	Fair	Poor
375	325	275	225	200	150

Thompson 1927 A1 Standard

A semi-automatic version of the Thompson submachine gun, chambered for the .45 ACP cartridge with a 16-1/2" barrel that is 18" with compensator. Blued with walnut stock. Weight is 13 lbs.

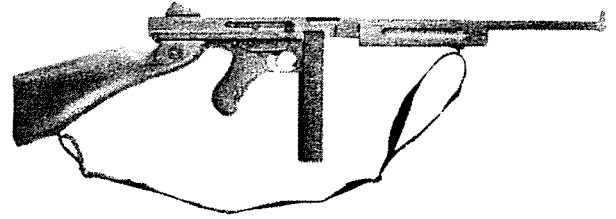

NIB	Exc.	V.G.	Good	Fair	Poor
950	750	500	400	300	150

1927 A1 Deluxe

As above, with a finned barrel, adjustable sights, pistol grip forearm, and a 50-round drum magazine costing an additional \$140. The violin-shaped carrying case adds approximately \$115 to the values listed below.

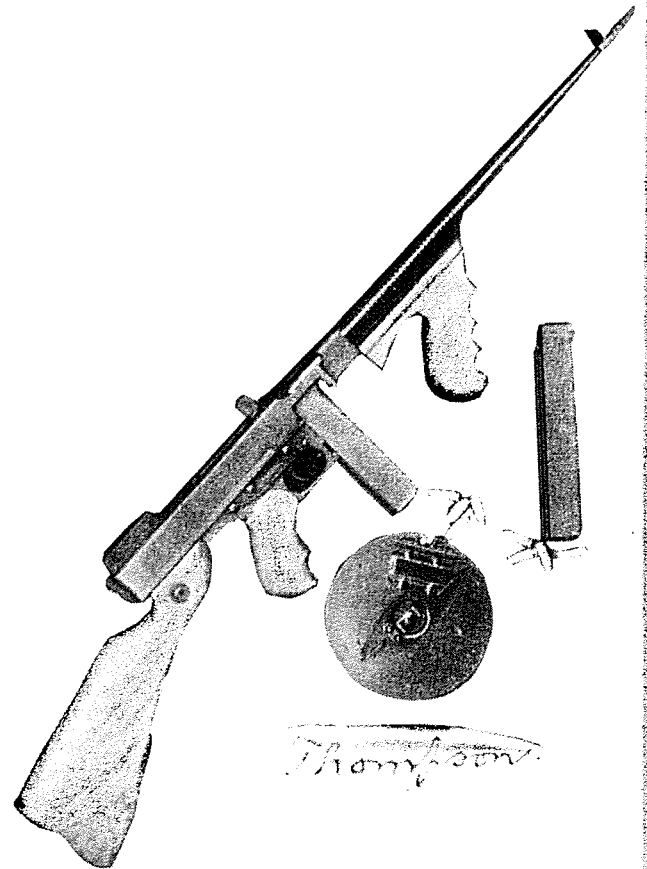

NIB	Exc.	V.G.	Good	Fair	Poor
950	750	500	400	300	150

1927 A1C

As above, with an aluminum alloy receiver. Introduced in 1984.

NIB	Exc.	V.G.	Good	Fair	Poor
925	700	500	400	300	150

1927 A1 Commando

Introduced in 1998 this version features a 16.5" finned barrel with compensator. The finish is parkerized with black wood fin-

h. Furnished with 30-round magazine and black nylon sling. Weight is about 13 lbs.

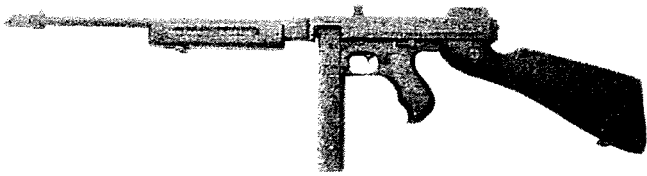

NIB	Exc.	V.G.	Good	Fair	Poor
950	750	500	—	—	—

1927 A5

A reduced-size version of the Model 1927 A1 with a 13" finned barrel, aluminum alloy receiver and no shoulder stock.

NIB	Exc.	V.G.	Good	Fair	Poor
725	625	500	400	300	150

1927 A3

.22 caliber variation of the Model 1927 A1 with a 16" barrel and aluminum alloy receiver. No longer in production.

NIB	Exc.	V.G.	Good	Fair	Poor
725	625	500	400	300	100

Auto-Ordnance M1 Carbine

Introduced in 2004 this M1 carbine version is fitted with a birch stock, metal handguard and parkerized finish. Barrel length is 18". Weight is about 5.5 lbs.

NIB	Exc.	V.G.	Good	Fair	Poor
610	475	—	—	—	—

Thompson Submachine Gun NFA

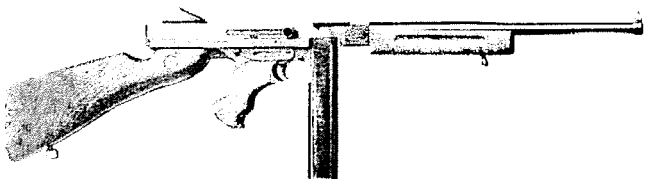

Auto Ordnance manufactured fully automatic reproductions of the Thompson Submachine Gun from approximately 1975 until the Firearm Owners Protection Act (Public Law 99-308, effective May 19, 1986) prohibited the transfer to private citizens of any machine guns that were not lawfully registered on the effective date of the 1986 Act. Some fully automatic .45 caliber Thompsons were manufactured, but their serial numbers are different from the .45 caliber guns described here, and are unavailable at this time.

With the exception of the .22 caliber guns earlier noted, all West Hurley Thompsons were caliber .45 automatic, manufactured in Model 1928 and M1 versions; however, the M1 designation "is actually incorrect, as the guns are in the M1A1 Thompson configuration" (see "The West Hurley M1 Thompson SMG," by Frank Iannamico, *Machine Gun News*, June 1995, pages 40-42). All of the so-called "West Hurley" Thompsons have the letter "A" suffix in the serial number and the West Hurley, New York, address stamped on the right side of the receiver. The Model 1928 has a 10.5" finned barrel with Cutts compensator (which adds about 2" to the barrel length); the M1 has a 10.5" plain barrel and no compensator.

The quality of the West Hurley Thompsons has been and continues to be actively debated. Some early guns were not well manufactured and required considerable work, while guns of later manufacture were of superior manufacture and expertly fitted, with some of varying quality in between. Auto Ordnance assembled many early guns with GI parts, and many collectors and shooters have replaced key parts with GI parts, in some cases to improve shooting performance. Each

gun must be evaluated individually by a qualified professional gunsmith and test fired to assess its quality of manufacture and/or mechanical/shooting proficiency, and the advisability of switching out factory parts for GI parts.

The original wholesale price of each model was \$525 (\$750 retail), and these values have risen dramatically along with the prices of many other machine guns, as demand has begun to catch up with the limited supply of "transferables" that was "frozen" by the 1986 Act. The M1 was manufactured only during 1985-86, and relatively few were made compared with the Model 1928, although the Model 1928 has so far been consistently valued higher. West Hurley Thompsons were originally considered "shooters" rather than collector's items, but the M1 (the so-called "Private Ryan" gun, after the movie), was recently ruled to be a "curio or relic" by ATF, and it seems reasonable to assume that the Model 1928 will eventually follow. The prices listed here are approximate, and reflect the premium that many people are willing to pay to own even a reproduction Thompson.

Total Model 1928 production was 3,306 guns, including Commemorative engraved Thompsons with various serial numbers, whose current retail prices may range from about \$7,500 to \$10,000 or more. (In 1992 there was a special run of 141 guns made for export or law enforcement only). The number of Commemorative guns manufactured are: World War II, 85 guns; Korean War, 145 guns; and Vietnam War, 17 guns. Total M1 production was 609 guns. There were also various special serial numbers included in the M1 production that are not listed; the factory would honor any request for a "special serial number," and these were not in the normal serial number ranges.

Model 1928 (serial numbered from 100A to 3159A?)

Exc.	V.G.	Good	Fair	Poor
6500	5750	5500	5000	4750

M1 serial numbered from M11A to M717A

Exc.	V.G.	Good	Fair	Poor
6000	5500	4750	4500	4250

The Violent Crime Control and Law Enforcement Act of 1994 (Public Law 103-322, effective September 13, 1994) has banned the production of certain so-called "assault weapons" and high-capacity ammunition feeding devices until 2004. Although those manufactured before September 13, 1994, can be and are imported regularly, some members of Congress have repeatedly introduced legislation that would prohibit their importation. As magazines wear out and replacements are sought, the prices and availability of high-capacity magazines continue to rise and vary dramatically. Standard GI Thompson 20- or 30-round stick magazines that once were plentiful and sold for \$5 to \$6, have increased to \$20 or more. Original Thompson drums have always been relatively costly, and prices of even West Hurley drums of modern manufacture suggest a high demand. New-in-box 50-round West Hurley L drums that last year were priced from \$350 to \$700 have risen to minimum asking prices of \$650, but not much higher; and 100-round C drums that last year were offered from \$750 to \$1,000, have risen to \$1,000 and higher. The quality of the West Hurley drums, particularly the 100-round C drums have been vastly criticized, and buyers would be well advised to request a demonstration before closing a purchase. As is the case with West Hurley Thompsons, some drums run flawlessly, others need work, and still others apparently are virtually unusable. The prices for vintage Thompson L drums range from \$650 and up, while the much-sought-after C drum commands \$3,000 or more. The uneven demand for these drum magazines precludes establishing firm retail prices at this time.

The Lightning Magazine Rifle from US Fire-Arms

[Sign In](#) | [Order Status](#)
 Call toll-free 877-372-3723



- 2006 Catalog
- Dealer Locator
- Media
- Resources
- Dealer Area
- Customer Support

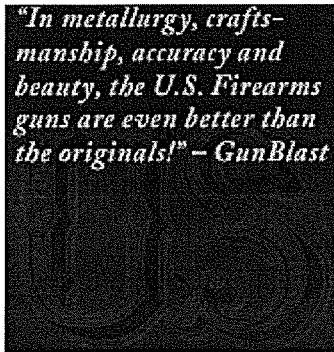

USFA Dealer

As federal law prohibits direct shipment of fire-arms, you must select a USFA stocking dealer where you gun(s) will be shipped.

Select a USFA Dealer

PDFs of Our Printed Retail Catalog

- [USFA 2006 Retail Pricing](#)
- [USFA 2005 Retail Catalog](#)

Safety & Instruction Manual

[Lightning Magazine Rifle Safety & Instruction Manual](#)



Standard



The Lightning Magazine Rifle

Cowboy shooters know that when seconds count you look for speed and accuracy in every shot. The USFA Lightning Rifle™ is built for this purpose. The most striking feature about the Lightning is the slide or pump mechanism. Many rifles of the Old West were lever action. This means the "Anchor Arm" breaks its hold in order to enable the lever to work the action. The result is that the 'anchor arm' causes the shooter to lose the critical barrel/target relationship. This unique benefit of the Lightning rifle is the ability of the shooter to never lose that critical "anchor arm" (regardless of whether you are right or left handed) and remain focused and ready on your target. When "Second Place is not an Option"... put your Score on the board with the Lightning Rifle.

The Lightning Rifle Was Produced from 1884 to 1904

Produced from 1884 to 1904, the Medium Frame Lightning Magazine Rifle was a dramatic innovation in breech loading firearms. A remarkably short action stroke, compact size, made the Lightning Magazine Rifle a success on the frontier.

In the 21st century, USFA uses the latest in modern Computer Aided Design/Computer Aided Manufacturing to reverse engineer and make new parts for our products. Having the right 'tools' is important but having the right skills and a good pair of hands is what makes USFA products better. 100% Made in America. Why buy anything else?

Like the original, our Premium Grade Lightning is available with a 26" Octagonal, or Round barrel. Upgrade to a Half-round barrel and choose a Standard Cresnet Butt or Upgrade to a Deluxe Grade Lightning with Deluxe Pistol Grip Stock in

Premium Grade Magazine Rifle Specifications

- Caliber:** 45 COLT
- Barrel Length:**
 - 26" Oct (+\$270.00)
 - 26" Round
 - 26" Half Round (+\$515.00)
- Wood Type & Grade:**
 - American Fancy Stock & Fore-End (+\$675.00)
 - Deluxe Stock & Fore-End (+\$1,350.00)
 - Exhibit Turkish Walnut Fore-End (Oil Finish)
- Wood Finish:** Oil Finish
- Stock Style:**
 - Straight Butt
 - Pistol Grip Butt (+\$32)
 - Straight Butt (+\$32)
 - "Prince" Round Knob (+\$325.00)
- Metal Finish:** High Polish
- Sights:** Rifle Buckhorn
- Magazine Capacity:** 15 Rounds
- Engraving:**
 - NO Engraving
 - Call for Price
- Optional Upgrade:**
 - Checkered Grip (+\$325.00)

Wood Samples

Browse our wood samples to choose the best one for your Lightning Upgrade.

- Fancy Grade (one step above standard),
- Deluxe Grade (two steps above standard)
- Exhibition (top of the line)

Lightning Engraving

Interested in engraving your Lightning Rifle? See our Lightning Rifle Engraving page.

Lightning Carbine

Check out The Premium Grade Lightning Carbine and Special Baby Carbine.

- The Premium Grade Lightning Carbine
- Special Baby Carbine

"An Exact Replica" - Guns of the Old West

"...the USFA lightning will appeal to collectors of old West firearms and those who can't find an original Lightning. And this is an exact replica. I've compared it side-by-side to Jay's original Colt, and the only difference that I can see between the two rifles is 100 years of honest wear. ...I think highly motivated CAS competitors are going to love it. Anyone with a yen for an authentic 19th century pump-action will have a hard time passing it by." - Guns of the Old West, Summer 2005.
 [Read the Entire Review \(pdf\).](#)

Armory Blue™ Finish. A High Polish Dome Blue™ with hand-polished blue barrel is the standard finish but a variety of options are available. See USFA Pricing guide (PDF) for details.

Fancy, Deluxe & Exhibition Walnut - Custom Gun Basics.

The start of any gun, rifle or pistol, begins with the selection of stocks or grips. The USFA Custom Shop maintains some of the highest quality wood for our custom gun customers. Imported from Turkey, all custom stock blanks are graded and selected for strength, figure and wood quality.



USFA has 4 grades; Standard, Fancy, Deluxe & Exhibition. For those who know the best.

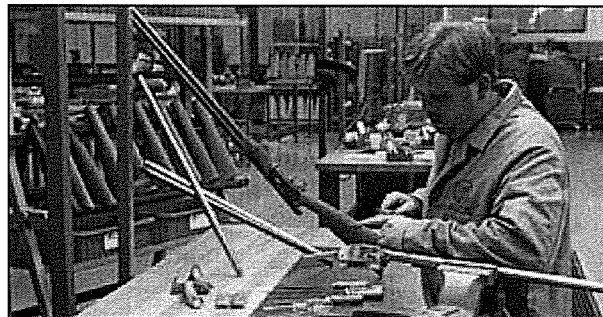

In the picture above a Lightning Rifle is being worked at the rifle benches. Hand filing of frames, barrels and stocks all done by a skilled hand. Achieving the right final contours, smooth actions, and finishes are the hallmark of USFA Premium Grades.

"A Fine Reproduction" - Guns of the Old West

"All in all, I enjoyed the USFA Lightning. It's got the looks, and it's a fine reproduction of a fine 19th Century design. ...It's a classic, 100% American. Made with modern steels, and just like the original."

Other Optional Upgrades: Full Nickel Blue Appoi Screws, Tri Gate, TRU-Contact US Shop.

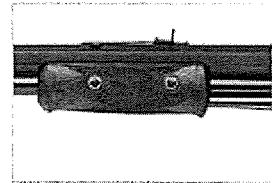

Premium Lightning Mag High Polish Dome Blue Polished Dome Blue Hal Barrel and Oil or TRU-O

Your Price: \$

Base Price/ea. \$1,480.

Update Price

Add to Cart

Fine Hand Ch

The first step in a hand pattern is the proper la proper style and proper established a series of r scribed from which all c This is the "old way" - t know. If you seek the b quality, you have found

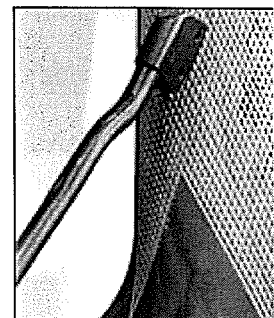

Engraving for You

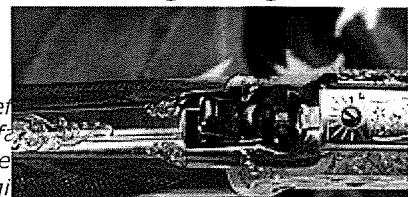

- *Guns of the Old West, Spring 2005.* [Read the Entire Review \(pdf\).](#)



[⇒ Click here for Light](#)

STARTING AT \$1,480 (MSRP)



Engraved Lightning Rifle → *Lightning Rifle Engraving Options*

© 2006 United States Firearms Mfg. Co., Inc. All Rights Reserved. Phone: (877) 227-6901. Email: usfa@usfirearm
USFA, 445 - 453 Ledyard St., Hartford, CT 06114-3211, U.S.A.

[Product Catalog](#) | [Contact Us](#) | [Customer Service](#) | [Custom Shop](#) | [Dealer Area](#) | [Dealer Locator](#) | [Engraving Co](#)
[Lightning Rifle Engraving](#) | [.22 Plinker](#) | [.22 Target](#) | [.45 A.C.P. "Lend Lease"](#) | [1910 Commercial Model](#)
[1911 Military Model](#) | [Ace .22 Long Rifle](#) | [Bisley](#) | [Cowboy](#) | [Custer Battlefield Gun](#) | [Deluxe Lightning](#)
[FlatTop Target Revolver](#) | [Gunslinger](#) | [Henry Nettleton](#) | [Lightning Magazine Rifle](#) | [Lightning Carbine](#) | [Magi](#)
[Magic Rifle Carbine](#) | [Omni-Potent Six-Shooter](#) | [Omni-Target Six-Shooter](#) | [Rodeo Gun](#) | [Sheriff's Mode](#)
[Single Action Revolver](#) | [Snubnose](#) | [Special Baby Carbine](#) | [Super 38 Automatic](#) | [US Pre-War](#) | [US 30 Cal](#)
[Current Ads](#) | [Editorials](#) | [High Resolution Gun Images](#) | [Published Reviews](#) | [USFA Product Videos](#) | [World of](#)

The Deluxe Lightning - The Finest Rifle Ever Made.

[Sign In](#) | [Order Status](#)
 Call toll-free 877-372-3723



- 2006 Catalog
- Dealer Locator
- Media
- Resources
- Dealer Area
- Customer Service

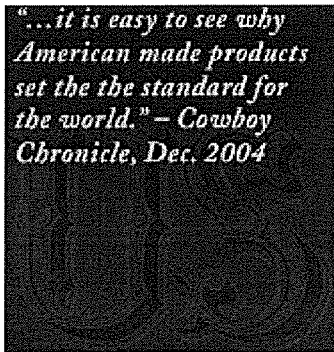

USFA Dealer

As federal law prohibits direct shipment of fire-arms, you must select a USFA stocking dealer where you gun(s) will be shipped.

Select a USFA Dealer

PDFs of Our Printed Retail Catalog

USFA 2006 Retail Pricing
 USFA 2005 Retail Catalog

Safety & Instruction Manual

Lightning Magazine Rifle
 Safety & Instruction Manual



Search

The Deluxe Lightning - The Finest Rifle Ever Made.



The Deluxe Grade is simply the best of everything - from wood quality to metal fit, polish and finish. A proper platform to begin your high grade engraving pattern or custom monogram finished off by hand checkering. The Deluxe Grade above features an optional up-grade to a custom "Prince of Wales" round knob shotgun butt; Up-grade to exhibition wood quality with Tru-Oil finish with hand checkered butt and fore end, as well as Armory Blue™ finish with fire blue appointments and full length 26" octagonal barrel with open sights.

Here is a classic heirloom to be enjoyed and passed down to the next generation. The USFA Custom Shop is known around the world as the best resource for this type of work. For assistance with customer specifications and order acceptance, please contact the USFA Custom Shop for details.

Fancy, Deluxe & Exhibition Walnut - Custom Gun Basics

The start of any gun, rifle or pistol, begins with the selection of stocks or grips. The USFA Custom Shop maintains some of the highest quality wood for our custom gun customers. Imported from Turkey, all custom stock blanks are graded and selected for strength, figure and wood quality.

The Deluxe Lightning - The Finest Rifle Ever Made. Specifications

- Caliber:** 45 COLT
- Barrel Length:**
 - 26" Oct
 - 26" Round
 - 26" Handmade (+\$140.00)
- Metal Finish:** Armory Blue Hand-Polish Barrel
- Magazine Capacity:** 15 Rounds
- Sights:** Rifle Buckhorn
- Wood Type & Grade:**
 - Fancy Stock & Fore End
 - Deluxe Stock & Fore End (+\$675.00)
 - Exhibition Turkish Walnut Fore End (+\$1000.00)
- Wood Finish:**
- Stock Style:**
 - Straight Butt
 - Pistol Grip Butt (+\$32)
 - Straight Butt (+\$32)
 - "Prince of Wales" Round Knob Butt (+\$600.00)
- Checkered Pattern:** Stock & Fore End on Deluxe
- Engraving:** NO Engraving Call for quote
- Optional Upgrades:** Full Nickel, Nickel & Gold, Blue Appointments. Contact USFA for details.

Scene Engraving

The motif below is typical of classic guns. Mythological creatures were often used for their fanciful and artistic composition. Attention to detail such as the border coverage with intertwined arrows and parchment scroll for name inscription or family motto forms an interesting and unique combination for your custom gun. A certain requested motif can be nicely incorporated into the medallions. The USFA Custom Shop stands ready to fulfill any request or modification you may desire. [More...](#)

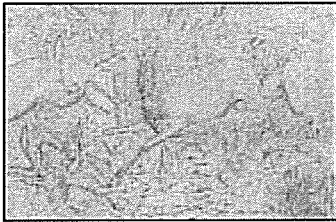

USFA has 4 grades; Standard, Fancy, Deluxe & Exhibition. For those who know the best.

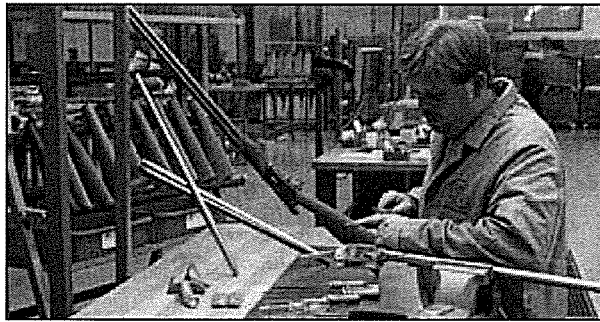

In the picture above a Lightning Rifle is being worked at the rifle benches. Hand filing of frames, barrels and stocks all done by a skilled hand. Achieving the right final contours, smooth actions, and finishes are the hallmark of USFA Premium Grades.

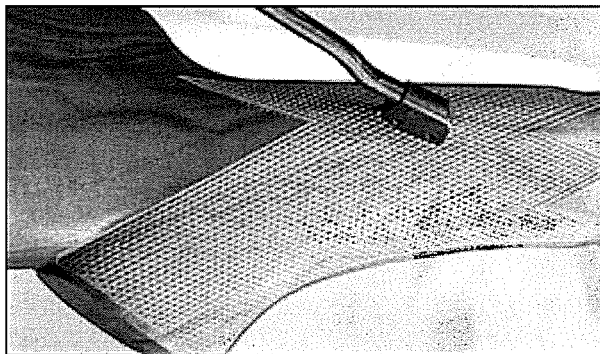

Fine Hand Checkering. The first step in a hand cut checkering pattern is the proper layout. After the proper style and proportion have been established a series of master lines are scribed from which all others are cut. This is the "old way" - the only way we know. If you seek the best, and know quality, you have found it.

[Shop.](#)

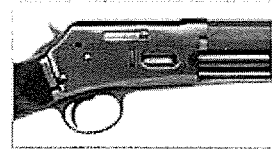

Your Price: \$

Base Price/ea. \$2,559.

[Update Price](#)

[Add to Cart](#)

Wood Samples

Browse our wood samples to find the best one for your Lightning Rifle.

- Fancy Grade (one standard)
- Deluxe Grade (two standard)
- Exhibition (top of line)

STARTING AT \$2,559 (MSRP)

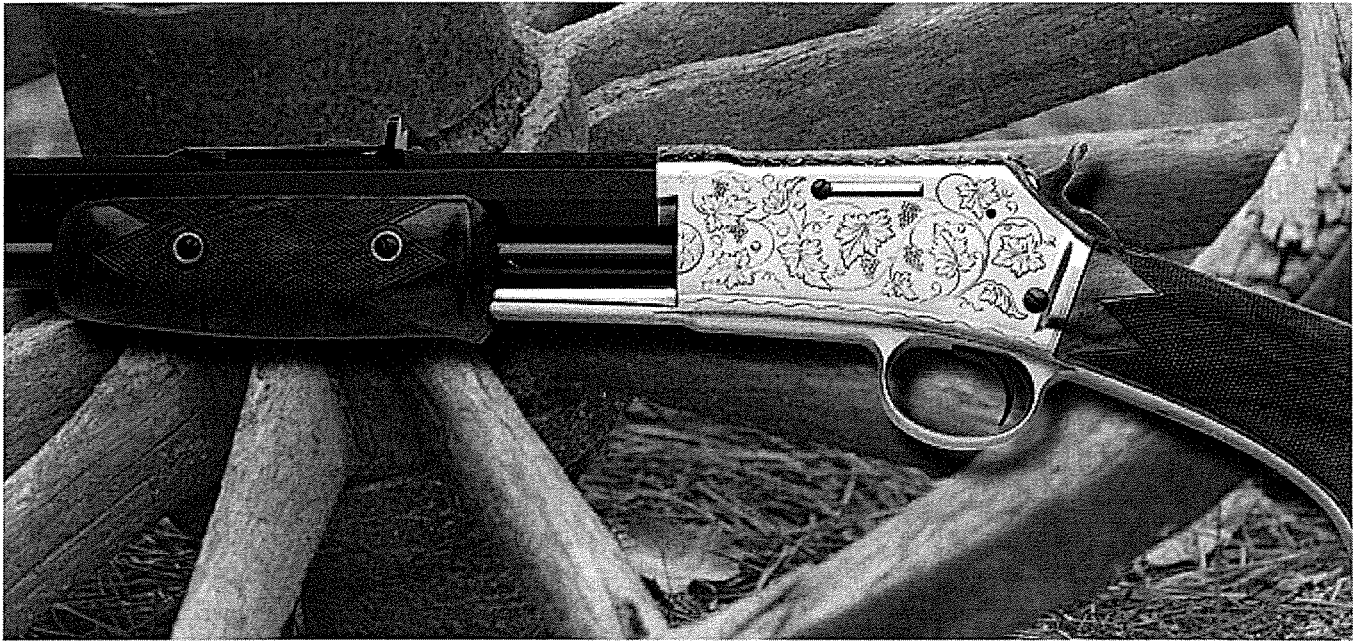

Engraved Lightning Rifle → *Lightning Rifle Engraving Options*

© 2006 United States Firearms Mfg. Co., Inc. All Rights Reserved. Phone: (877) 227-6901. Email: usfa@usfirear
USFA, 445 - 453 Ledyard St., Hartford, CT 06114-3211, U.S.A.

[Product Catalog](#) | [Contact Us](#) | [Customer Service](#) | [Custom Shop](#) | [Dealer Area](#) | [Dealer Locator](#) | [Engraving Co](#)
[Lightning Rifle Engraving](#) | [.22 Plinker](#) | [.22 Target](#) | [.45 A.C.P. "Lend Lease"](#) | [1910 Commercial Model](#)
[1911 Military Model](#) | [Ace .22 Long Rifle](#) | [Bisley](#) | [Cowboy](#) | [Custer Battlefield Gun](#) | [Deluxe Lightning](#)
[FlatTop Target Revolver](#) | [Gunslinger](#) | [Henry Nettleton](#) | [Lightning Magazine Rifle](#) | [Lightning Carbine](#) | [Magi](#)
[Magic Rifle Carbine](#) | [Omni-Potent Six-Shooter](#) | [Omni-Target Six-Shooter](#) | [Rodeo Gun](#) | [Sheriff's Mode](#)
[Single Action Revolver](#) | [Snubnose](#) | [Special Baby Carbine](#) | [Super 38 Automatic](#) | [US Pre-War](#) | [US 30 Cal](#)
[Current Ads](#) | [Editorials](#) | [High Resolution Gun Images](#) | [Published Reviews](#) | [USFA Product Videos](#) | [World of](#)