

### AFFIDAVIT OF MATTHEW WILSON

Comes now Matthew Wilson, being first sworn, and states under penalties of perjury, as follows:

1. My name is Matthew Wilson. I am one of the Plaintiff's in this case.
2. I have been provided, and have read, the Supplemental Affidavit of James E. Yurgealitis, filed as document 116-1.
3. Unlike Mr. Yurgealitis, I am being provided no compensation for my testimony or participation in this case.
4. After reading said Supplemental Affidavit, I seriously question the purported knowledge that Mr. Yurgealitis claims to possess, as he makes bald statements of fact that are objectively simply not true.
5. For instance, Mr. Yurgealitis claims that, in 9mm, the following handguns feature 15 round magazines that are not interchangeable with any rifles or other long guns, and listed the following:
  - a. CZ: Model 75, Shadow;
  - b. Heckler & Koch: P30, P2000, USP;
  - c. Sig Sauer: P226, P229;
  - d. Smith & Wesson: 5900 Series, SW40F;
  - e. Sturm Ruger: P85, P89;
  - f. Springfield Armory: XD Series; and
  - g. Walther: P88, PPQ, PDP.
6. Mr. Yurgealitis' statement is largely false, to wit:
  - a. The CZ, Model 75 and the Shadow are variants of the same pistol, use the same magazine, and the magazines are also used in the Kel Tec Sub 2000 Gen

2 rifles. See Ex. A, B, C.D. These are also similar to the Tanfoglio TZ75, formerly imported by FIE or Florida in the 1980s, and the AR-24 Pistol, formerly imported by Armalite, which itself is a CZ75 clone.

- b. As far as the Smith and Wesson 5900 Series, the pistol is discontinued, but uses the same magazine as the also discontinued Marlin Camp rifle, in 9mm. See Ex E. Marlin camp rifles used to be sold as most Wal-Marts.
- c. As to the Ruger P85 and P89, they are variants of the same basic pistol, the P89 being a product improved variant of the P85. Both pistols use the same magazine as the Ruger PC9 rifle. See. Ex. F, G.
- d. As to the Springfield Armory XD Series, it is actually a Croation made pistol, made by HS Produkt, and the magazines it uses are largely interchangeable with the Beretta M92 Series, except that one needs to cut a single notch in the XD magazines to make them work in the M92, or a single notch in a M92 Beretta magazine to make them work in an XD. In fact, during the mid to late 1990s, when new over 10 round magazines were restricted, but existing over 10 round magazines were unrestricted, it was common for owners of XD pistols to obtain surplus M92 magazines and modify them for use in the XD pistol.

7. While I am personally unaware of any rifles that use the other listed magazines, there is no reason that such a rifle could not be constructed, nor is there any way to know whether or not any such rifles have been so constructed and sold. Any claim that *any* magazine can *only* fit a handgun or *only* fit a rifle is absurd on its face. In fact, any handgun, ultimately, can be converted into a rifle. For instance, as listed in the ban itself, DSA

makes or made a FAL pistol. The FAL magazine is very similar to the M14 magazine in size and general design.

8. As far as owners of M9 / Beretta M92 style 9mm pistols, who are also owners of Beretta CX4 rifles, I am on, as are the other two named Plaintiffs in this lawsuit. If the Court would care to see a demonstration of the interchangeability of the magazines in my Beretta Pistol and rifle, I am happy to personally demonstrate same.
9. Furthermore, from a purely technical perspective, there is and are no reasons why a 20, 30 or 40 round magazine could not be modified to accept and feed only either 15 rounds, 10 rounds or even 5 rounds. In the 1950s, it was a common practice for owners of M1 Carbines, which come standard with 15 or 30 round magazines, to convert 30 round magazines to 5 round magazines to comply with the hunting regulations of the era, since it was cheaper to convert a 30 round magazine than to make a 5 round magazine new. The issue, is how is one to know that a given 15 through 11 round magazine is a “handgun magazine” as opposed to a “rifle magazine.”, or a 16 round magazine is for a firearm other than a rifle, shotgun or handgun, as defined. The ambiguity is on the magazine, not the firearm it may fit into.
10. In fact, depending on the cartridge used, a magazine that holds 30 rounds of one cartridge may well only hold 10 rounds of another. One such actual example is the AR15 magazine, in which its standard magazine holds 30 rounds of 5.56mm ammunition, or 10 rounds of .50 Beowolf ammunition, interchangeably.
11. Defendant’s expert also says,:

35. With AR platform or “AR Type” rifles, the magazines can be interchangeable between rifle and handgun variants. However, both variants are firearms that can no longer be legally purchased under the Act.

12. I am familiar with the AR7 rifle, a photograph is shown below:



13. A close up of the markings on an AR7 rifle are shown below:

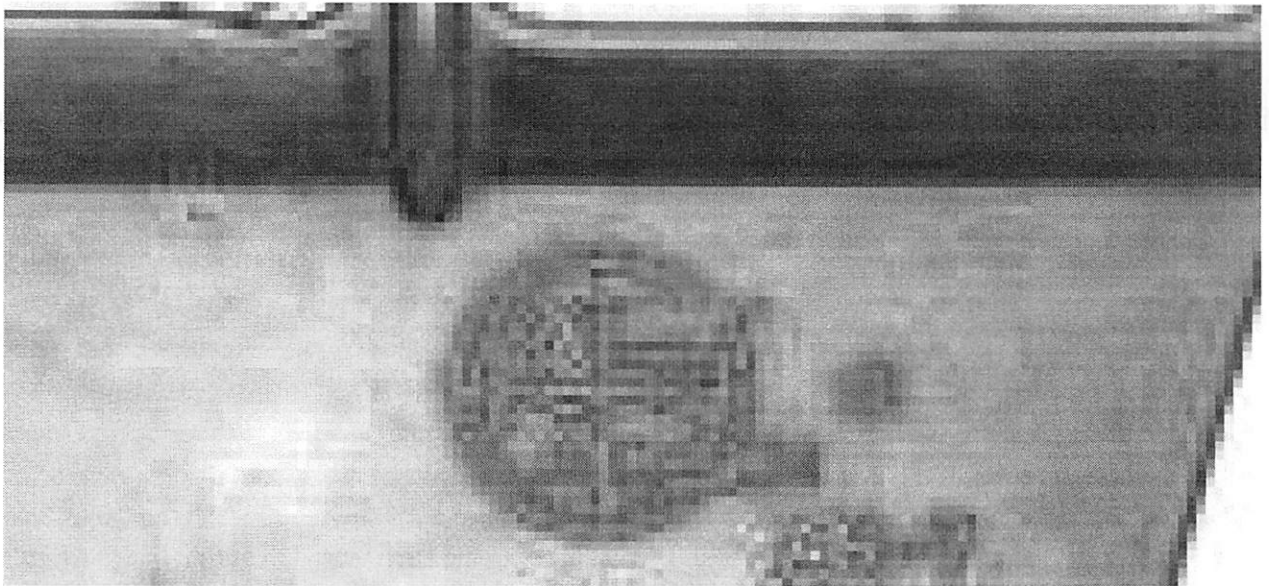

14. As can be clearly seen, the above firearm is marked as an “AR-7.”

15. I acknowledge there are both handgun and rifle versions of this firearm. However, other than the AR-7 marking, I see no reason why, under the challenged act, this firearm cannot be sold or possessed, unless this is an “AR Type” firearm, which, while marked as an AR-7, I have no idea and to not see how to discern whether this is an AR type firearm.

16. Below is depicted another firearm. From my knowledge of firearms, I can see that the AR15 has clearly influenced the design, and it appears to use an AR15 type magazine. However, I have no idea if that is an “AR Type” firearm or not.



17. I am also aware of a firearm called an AR5, below is a photograph.

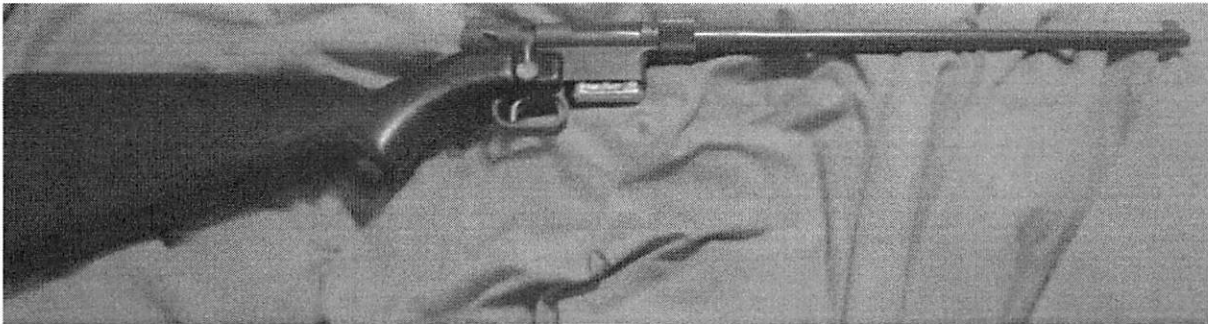

18. This is a bolt action firearm with a 4 round magazine. I do not know if this is included in the definition of an “AR type” firearm.

19. In addition, some firearms that look kind of like an AR15 are bolt action or straight pull bolt action, not semiautomatic. A photograph of one such firearm is shown below.



20. There have also been pump action firearms that look like AR15 rifles. A photograph of one such rifle is shown above.

21. I do not know if this rifle is included in the definition of “AR type,” nor can I discern it, as no definition is provided.

22. As for semi-automatic 1919A4 types, they are common as dirt in Illinois. For several years they were built by many manufacturers and home builders of firearms, as the parts

from which they were made were surplus and low cost for many years. Contrary to the expert opinion, they remain in production to this case. Ex. I.

FURTHER AFFAINT SAYETH NAUGHT

DATED: 6-27-2023

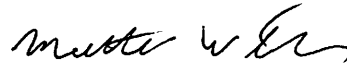

Matthew Wilson

SUBSCRIBED AND SWORN

Dated: 6-27-2023



Notary





**DAILY DEALS**

Free Shipping on Uppers, Rifle Kits, Pistol Kits, Build Kits, Part Kits, Complete Lower & PSA Firearms!



[HOME](#) / KEL-TEC MAG CATCH KIT FOR CZ75 SUB 2000 GEN2 RIFLES, BLACK - S2K-205CZ75

IN STOCK ▶

## KEL-TEC MAG CATCH KIT FOR CZ75 SUB 2000 GEN2 RIFLES, BLACK - S2K-205CZ75

IN STOCK ▶

## KEL-TEC MAG CATCH KIT FOR CZ75 SUB 2000 GEN2 RIFLES, BLACK - S2K-205CZ75

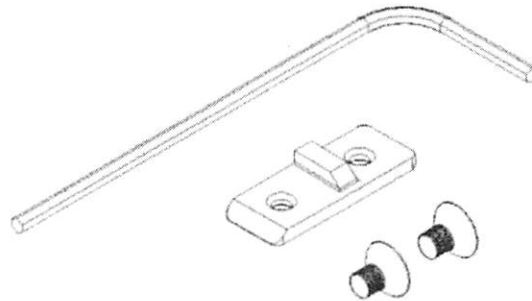

**\$12.09**

- 1 +

**ADD TO CART**

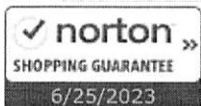

Read Compliance Information before purchasing.

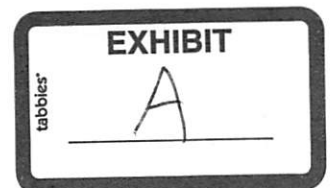







 This product is fulfilled by a PSA Partner and shipping times may vary. **DAILY DEALS**



Model Number S2K205CZ75

UPC 640832007329

 Add to Wish List  Add to Compare Share:   

Purchase protected by  **norton** SHOPPING GUARANTEE [Learn more](#)

## PRODUCT DETAILS

### DETAILS

Material: Steel

Color: Black

For Use With: CZ75 Sub 2000 Gen2 Rifles

Includes: (1) Mag Catch Plate, (1) Hex Key, (2) Screws

### FEATURES

The CZ 75 Sub 2000 Gen2 mag catch kit, from Kel-Tec comes with hey key and screws.

The Mag Catch plates will only work in the Gen 2 SUB 2000 weapon, which states "multi mag" on the left hand side of the grip.

## REVIEWS





**DAILY DEALS**



## COMPLIANCE

### Shipping Restrictions

It is the customer's responsibility for understanding state laws regarding all purchases made. For a comprehensive list of all Shipping Restrictions, please refer to our Shipping Restrictions By State Page found [Here](#).

#### All NFA Rules Apply.

These items are controlled by the U.S. Government and authorized for export only to the country of ultimate destination for use by the ultimate consignee or end-user(s) herein identified. They may not be resold, transferred, or otherwise disposed of, to any other country or to any person other than the authorized ultimate consignee or end-user(s), either in their original form or after being incorporated into other items, without first obtaining approval from the U.S. government or as otherwise authorized by U.S. law and regulations.



#### AMENDMENT II

*A well regulated Militia, being necessary to the security of a free State, the right of the people to keep and bear Arms, shall not be infringed.*

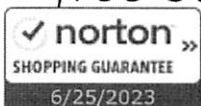



**DAILY DEALS**

Sign up for our Daily Deals and News



Questions? Need help? Call us: (877) 560-7229

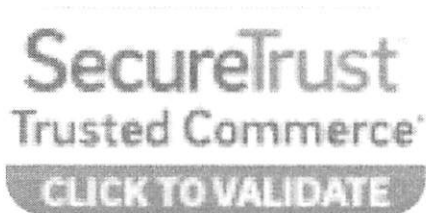

About SSL Certificates

COMPANY      INFO      LEGAL      CONTACT INFORMATION

Blog      Check Shipping Status      Terms & Conditions      Palmetto State Armory  
Careers      My Account      Retail Return Policy      3760 Fernandina Rd.  
Columbia, SC 29210

About PSA      Contact Us      Shipping Restrictions

Affiliate Program      Rebates & Promotions      Privacy Policy      **HELP CENTER**

Retail Stores      Compare Products      Sitemap

Defense Courses      Check Order Status

SC CWP Info      Gift Card Balance

Shoot ResponsiblyFAQ

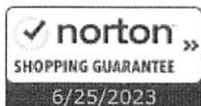

Buying a Gun Online

FFL Locator

Product Manuals

California Buying Guide

DAILY DEALS



ARMORY. ALL RIGHTS RESERVED.

[Home](#) / [Magazines](#) / S2K-205 CZ75 Mag Catch Kit

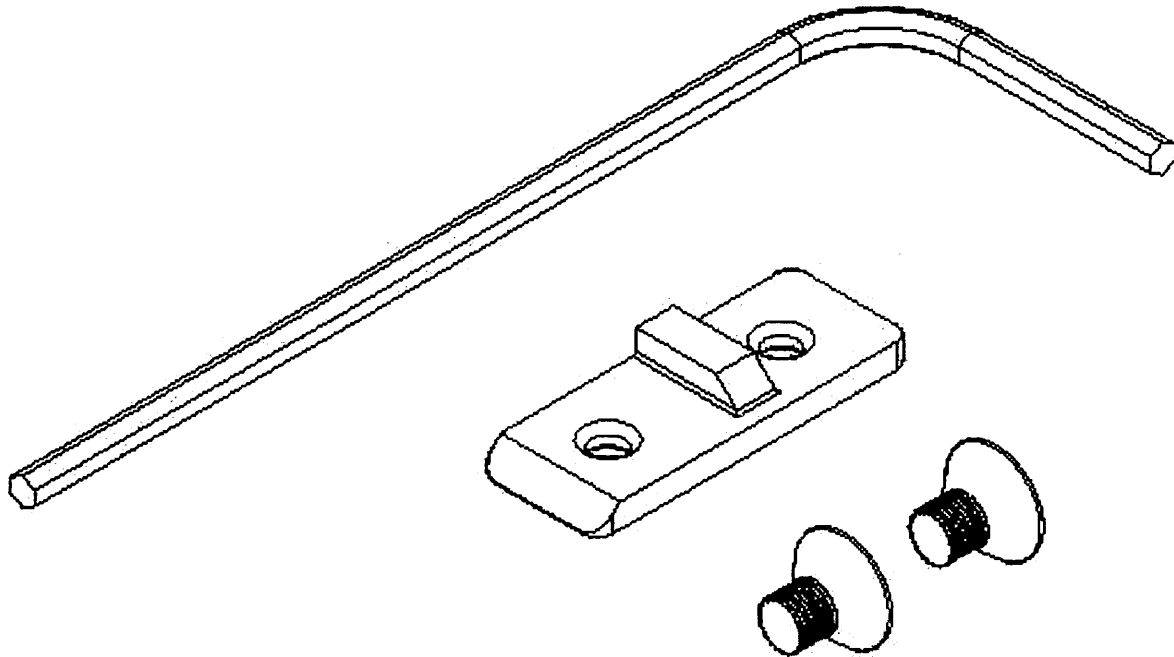

## S2K-205 CZ75 Mag Catch Kit

**SUB 2000 2ND GEN CZ75 MAG CATCH KIT**

THE MAG CATCH PLATES WILL ONLY WORK IN THE GEN 2 SUB 2000 WEAPON, WHICH STATES "MULTI MAG" ON THE LEFT HAND SIDE OF THE GRIP.

**INCLUDES;**

- 1- CZ75 MAG CATCH PLATE
- 1- HEX KEY
- 2- SCREWS

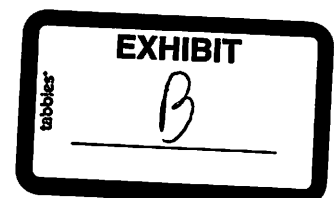

[Pistols](#) [Rifles](#) [Shotguns](#) [Parts](#) [Accessories](#) [Gear](#) [Sign In](#)

**\$13.99**

1

ADD TO CART

PRODUCT CODE: S2K-205CZ75 CATEGORY: [Magazines](#)

## KELTEC INFO:

[About](#)  
[Careers](#)  
[Distributor List](#)  
[HALO](#)  
[Media Kit](#)  
[Terms & Conditions](#)  
[Privacy Policy](#)  
[Sitemap](#)

---

## FIREARM INFO:

[Recall](#)  
[Owner's Manuals](#)  
[Discontinued](#)  
[Digital Catalog](#)  
[U.S. Firearm Magazine Restrictions](#)

---

## NEWS:

[Press](#)  
[KelTec Insider](#)

---

## CUSTOMER SERVICE:

[Gift Cards](#)  
[Shipping & Returns](#)



[Pistols](#)

[Rifles](#)

[Shotguns](#)

[Parts](#)

[Accessories](#)

[Gear](#)

[Sign In](#)



[Support Ticket](#)

[Contact](#)



***KELTEC***<sup>®</sup>





CZ

SHOWING ALL 11 RESULTS

FILTER

SORT BY LATEST

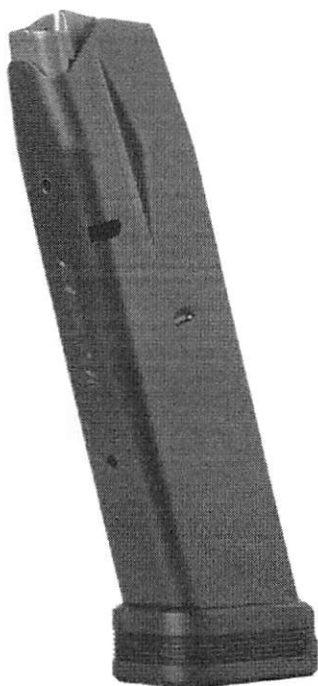

COMPETITION CZ 75B / 85B / SP-01 / SHADOW / SHADOW 2  
9MM 10-ROUND

\$68.25

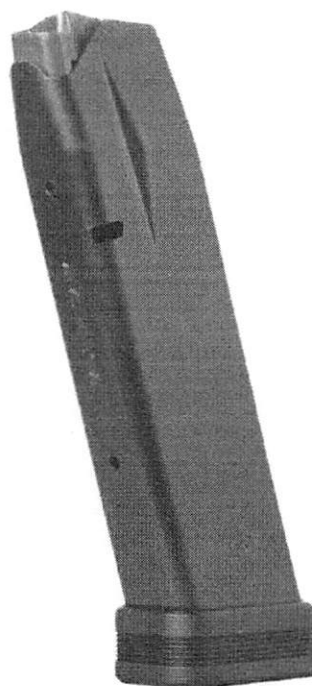

COMPETITION CZ 75B / 85B / SP-01 / SHADOW / SHADOW 2  
9MM 19-ROUND

\$68.25

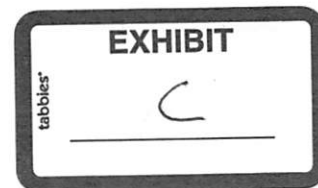



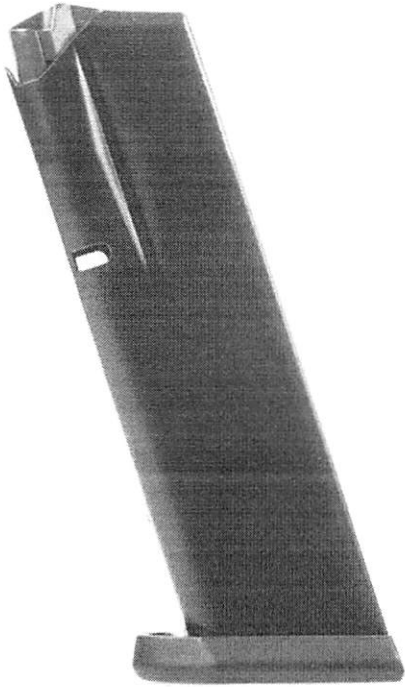

CZ 75 COMPACT / P-01 / PCR 9MM 15-ROUND  
\$40.20

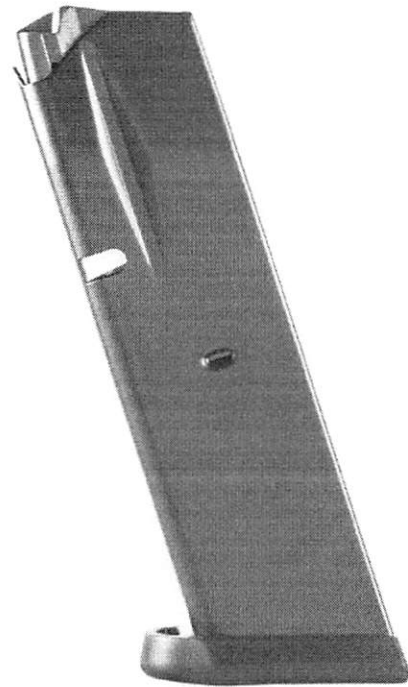

CZ 75 COMPACT / P-01 / PCR 9MM 10-ROUND  
\$32.65

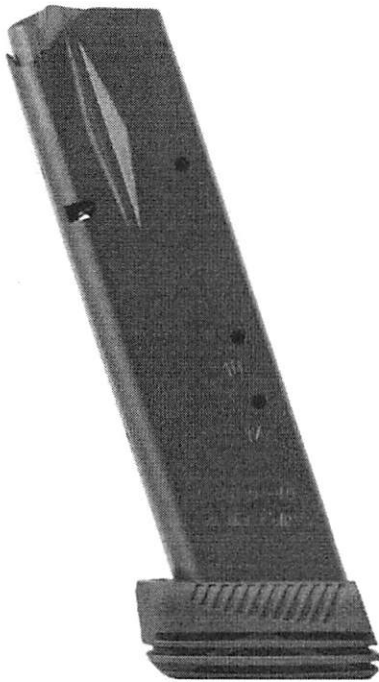

CZ 75B / 85B / SP-01 / SHADOW / SHADOW 2.40 S&W 14-ROUND  
DPS  
\$48.85

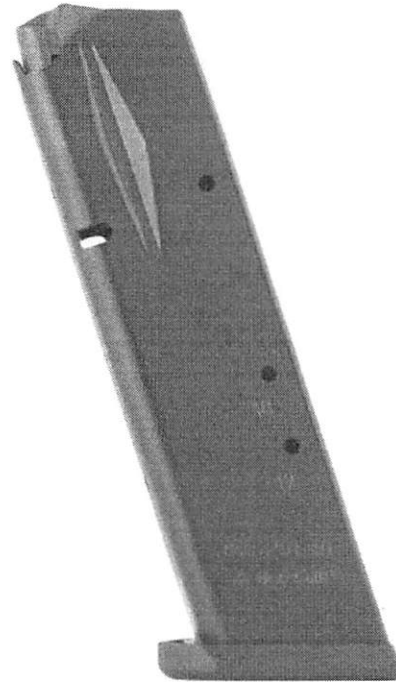

CZ 75B / 85B / SP-01 / SHADOW / SHADOW 2.40 S&W 12-ROUND  
\$40.20

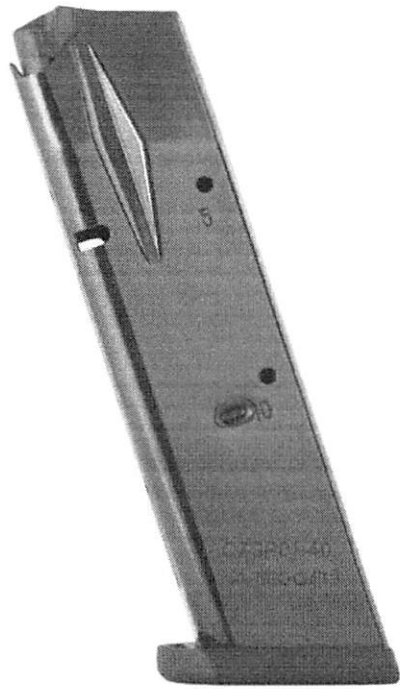

CZ 75B / 85B / SP-01 / SHADOW / SHADOW 2 .40 S&W 10-ROUND  
\$32.65

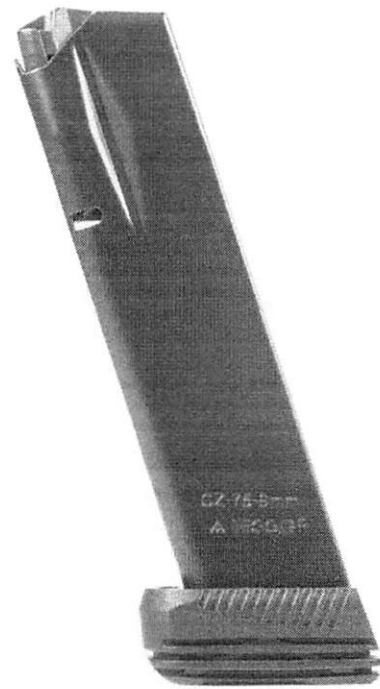

CZ 75B / 85B / SP-01 / SHADOW / SHADOW 2 9MM 19-ROUND  
DPS  
\$49.85

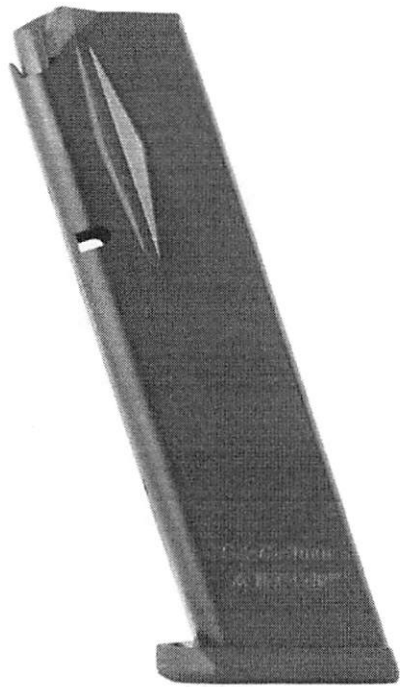

CZ 75B / 85B / SP-01 / SHADOW / SHADOW 2 9MM 17-ROUND  
\$41.05



CZ 75B / 85B / SP-01 / SHADOW / SHADOW 2 9MM 16-ROUND  
\$33.30

SOLD OUT

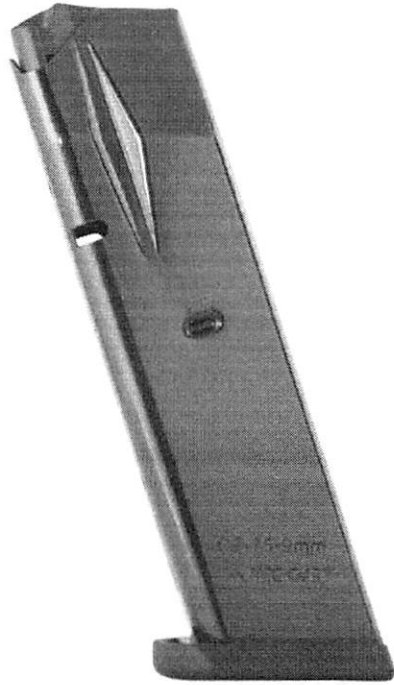

CZ 75B/85B/SP-01/SHADOW/SHADOW 2 9MM 10-ROUND

\$33.30



905 Middle Street  
Middletown, CT  
06457 USA

mags@mec-gar.com

(860) 635-1525



### Magazines

1911  
ARMSCOR/Rock Island Double Stack  
Bersa

1911 Officer  
Beretta  
Browning

CZ  
Luger  
Ruger  
Sig Sauer  
Taurus  
Witness - Tanfoglio

Kimber  
Para-Ordinance  
S&W  
Springfield  
Walther

## About

Blog / News  
IFS+ - Innovation For Shooters  
Contact Us



## Help

FAQ  
Contact Us

© 2001 - 2022 Mec-Gar USA Inc. - All rights reserved.  
[Terms and Conditions](#) | [Privacy](#) | [Legal Notice](#) | [Cookie Policy](#)



We accept



STORE › MAGAZINES › CZ

CZ 75B / 85B / SP-01 / SHADOW / SHADOW 2.40  
S&W 12-ROUND



**Compatible Firearms:** CZ 75B, 85B, SP-01, Shadow, Shadow 2

**Caliber:** .40 S&W

**Capacity:** 12 rounds (+1 round compared to factory magazines and still flush fit)

**Coating:** Anti-friction

**Follower:** High-impact polymer

**Tube:** Heat treated carbon steel

**Spring:** High tensile music wire

**Floorplate:** High-impact polymer that sits flush with the pistol

**SKU (Blued):** MGCZ4012AFC – **UPC:** 765595515727

- Anti-Friction coating allows for easy loading, reduced malfunctions, and superior anti-corrosion properties

 IN STOCK

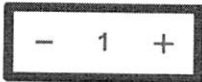

ADD TO CART



 **State Capacity Restriction**



**Safe Shopping**

Buy with confidence, your data is safe.

**Flat-Rate Shipping**

Get your items quickly with flat-rate USPS.

SKU: MGCZ4012AFC

SHARE      

**Description**



**.40 S&W - 12 rounds**

If you are looking for a magazine for your CZ 75B, 85B, SP-01, Shadow, Shadow 2 pistol, choose the magazine manufacturer that is the most trusted in the industry.

All Mec-Gar magazines are made in Italy with the most sophisticated technologies and best materials.

Since 1965 Mec-Gar has been a world leader in the production of magazines for the largest firearm manufacturers and militaries in the world.

## Specifications

<b>CALIBER</b>	.40 S&W
<b>CAPACITY</b>	12-round
<b>FINISH</b>	Anti-Friction
<b>FIREARM MAKE</b>	CZ
<b>MODEL</b>	CZ 75B, CZ 85B, CZ Shadow, CZ Shadow 2, CZ SP-01

REVIEWS (0) +





905 Middle Street  
Middletown, CT  
06457 USA

mags@mec-gar.com  
(860) 635-1525



## Magazines

1911	1911 Officer
ARMSCOR/Rock Island Double Stack	Beretta
Bersa	Browning
CZ	Kimber
Luger	Para-Ordnance
Ruger	S&W
Sig Sauer	Springfield
Taurus	Walther
Witness - Tanfoglio	

## About

Blog / News  
IFS+ - Innovation For Shooters  
Contact Us



secured by

**Help**

FAQ

Contact Us

© 2001 - 2022 Mec-Gar USA Inc. - All rights reserved.

[Terms and Conditions](#) | [Privacy](#) | [Legal Notice](#) | [Cookie Policy](#)



We accept

Toggle the table of contents

# Marlin Camp Carbine

The **Marlin Camp Carbine** is a self-loading carbine chambered for either 9mm Parabellum or .45 ACP, formerly manufactured by Marlin Firearms Company of North Haven, Connecticut. The carbine has been discontinued since 1999.<sup>[1][2]</sup>

## Description

As the name implies, it was designed as a utility firearm to be used around hunting camps for foraging or defense. It was made in 9mm Parabellum and .45 ACP calibers and can use the same magazines as popular handguns in those calibers, in keeping with a convenient American tradition of having a carbine and handgun using common ammunition. The carbine operates by direct blowback. Usually, the receiver is drilled and tapped for a scope mount. The stock was made of walnut-finished Maine birch.<sup>[1][3]</sup>

The Camp Carbine uses a detachable magazine that inserts into the magazine well in front of the trigger guard. The Camp-45 rifle magazine is compatible with most Colt 1911-type magazines; and the Camp-9 rifle magazine can be replaced by magazines from 59-series S&W pistols.<sup>[1]</sup> The Camp-9 magazine well is sized for 12-round magazines; magazines with higher capacities extend beyond the bottom of the well. A 20-round magazine was produced, but discontinued in 1989.<sup>[1][2]</sup> Numerous aftermarket magazines and drums were produced for both models.

## References

- Fjestad, S.P. (2009). *Blue Book of Gun Values 2009*. Blue Book Publications. p. 798. ISBN 978-1-886768-87-1.
- Warner, Ken (1999). *Gun Digest 2000, 54th Annual Edition*. Krause Publications. p. 306. ISBN 0-87341-752-6.
- William S. Brophy. *Marlin Firearms: A History of the Guns and the Company That Made Them*. p. 319.

## External links

- Marlin "Camp 9" Carbine (<https://web.archive.org/web/20211024212259/http://www.alpharubicon.com/leo/marlincamp9war.htm>)
- Marlin Camp Carbines (<https://web.archive.org/web/20221208170544/http://notpu/campgun9.htm>)

### Marlin Camp Carbine



Marlin Camp-45

<b>Type</b>	Hunting rifle
<b>Place of origin</b>	United States
<b>Production history</b>	
<b>Manufacturer</b>	Marlin Firearms Company
<b>Produced</b>	1985–1999
<b>Variants</b>	9mm and .45 ACP Versions
<b>Specifications</b>	
<b>Mass</b>	6¾ pounds
<b>Length</b>	35½"
<b>Barrel length</b>	16½"
<b>Cartridge</b>	.45 ACP 9mm Parabellum
<b>Action</b>	Direct blowback semi-automatic
<b>Feed system</b>	4 or 7-round (Camp-45) 4, 12, or 20-round (Camp-9) Detachable pistol magazine
<b>Sights</b>	Fixed, drilled, and tapped for scope mounts

EXHIBIT

tabbies

E

- [Marlin Camp 9 Manual \(https://web.archive.org/web/20230110172931/http://pdf.textfiles.com/manuals/FIREARMS/marlin\\_9.pdf\)](https://web.archive.org/web/20230110172931/http://pdf.textfiles.com/manuals/FIREARMS/marlin_9.pdf)
- [Marlin Camp 45 Manual \(https://archive.org/details/marlin-model-45-manual/\)](https://archive.org/details/marlin-model-45-manual/)

---

Retrieved from "[https://en.wikipedia.org/w/index.php?title=Marlin\\_Camp\\_Carbine&oldid=1149948132](https://en.wikipedia.org/w/index.php?title=Marlin_Camp_Carbine&oldid=1149948132)"

**Toggle limited content width**

BOTACH®

Cart

Search the store



**Log In / Register** to View **Member Pricing** if Available. Use The **Request For Quote Button** For RFQs, Quantity Discounts, Out-Of-Stock Items, or Agencies / Qualified Individuals Looking to Purchase & Ship **Regulated Products to Restricted States.**

- 10% OFF Storewide use coupon code JULY4 At Checkout -

HOME / GUN MAGAZINES / RUGER PC9 & P89 9MM 15-ROUNDS MAGAZINES

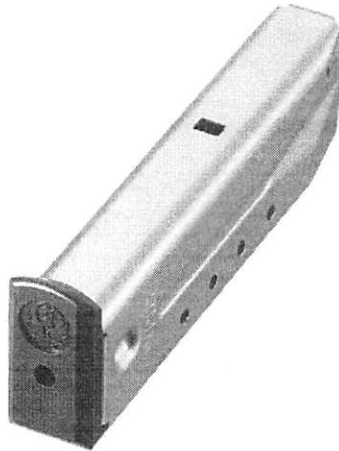

DEALS

RUGER

### Ruger PC9 & P89 9mm 15-Rounds Magazines

★★★★★ (No reviews yet)

[Write a Review](#)

SKU: Ruger-90233

UPC: 736676902330

MPN: 90233

WEIGHT: 0.20 LBS

\$27.98

or 4 interest-free payments of \$7.00 with sezzle

PayPal Checkout Disabled Due to Restrictions.

QUANTITY:

Quantity selector: 1

ADD TO CART



#### Related Products

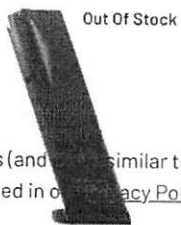

Out Of Stock



Out Of Stock



Out Of Stock

We use cookies (and similar technologies) to collect data to improve your shopping experience. By using our website, you're agreeing to the collection of data as described in our [Privacy Policy](#).

Settings Reject all Accept All Cookies

BOTACH®

Cart

CZ \$47.98	Ruger American 9mm Magazines 17-Rounds Ruger \$29.98	Ruger Security American Compact 9mm 12- Rounds Magazines Ruger \$29.98	Magazines Ruger \$19.98	Magazines Ruger \$29.98
---------------	---	--	-------------------------------	-------------------------------

Customers Also Viewed

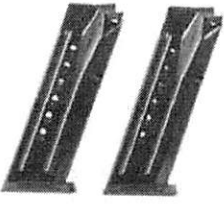

**ADD TO CART**

Ruger Security-9 9mm  
15-Rounds Magazines 2  
Pack  
Ruger  
\$47.99



**ADD TO CART**

Ruger American 9mm  
Magazines 17-Rounds  
Ruger  
\$29.98



**ADD TO CART**

Ruger, LCP II 22LR  
Threaded Barrel Kit, 1/2 x  
28 RH Threads, Fits LCP  
II 22LR  
Ruger  
\$160.95



**ADD TO CART**

Ruger LC Carbine  
5.7x28mm 16.25" 20+1rd  
Rifle  
Ruger  
\$699.98

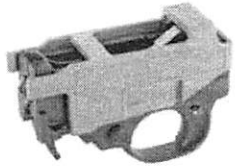

**ADD TO CART**

Ruger 90462 BX-Trigger  
Fits 10/22  
Ruger  
Now: \$69.98 Was:  
\$96.95



**DEALS**

Ruger AR  
F  
Now: \$7  
\$€

Description

Ruger 9mm Luger 15rd magazine for the P89 (Serial No. 304-70000 & Above), P93, P94, P95 pistols & PC9 Carbine.

- Pricing Unit: Each
- Model: P-Series
- UPC: 736676902330
- SKU: 90233
- Width: 3.50
- Length: 7.50
- Height: 1.50
- Weight: 0.20
- Caliber: 9mm
- Capacity: 15 Rounds
- Dimension: 1.50 X 3.45 X 6.70
- Finish: STAINLESS STEEL (SILVER)
- Series: Magazine
- Similar Items: CLRUG
- Style: Detachable

**WARNING** This product may contain chemicals known to the State of California to cause cancer and birth defects or other reproductive harm. For more information go to [www.P65Warnings.ca.gov](http://www.P65Warnings.ca.gov). You must be 18+ years old to shop and or purchase on our website and 21+ to purchase Ammunition/Firearms. Check local laws before ordering as you certify you are of legal age and satisfy all federal, state, and local legal/regulatory requirements. There are NO returns or exchanges on armor, firearms, ammunition, PPE equipment. Ammo ships UPS ground to the lower 48 states.

**VIEW ALL** We use cookies (and other similar technologies) to collect data to improve your shopping experience. By using our website, you're agreeing to the collection of data as described in our [Privacy Policy](#).

Additional Information



<https://shopruger.com/login.asp>

<https://shopruger.com/basket.asp>

All Items (default.asp) / Centerfire Pistol Accessories (Centerfire-Pistol-Accessories/departments/1000/) / P-Series (P-Series/departments/1400/) / Magazines & Loaders (Magazines-Loaders/products/1401/)

## P-Series 9mm 15-Round Magazine

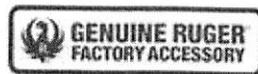
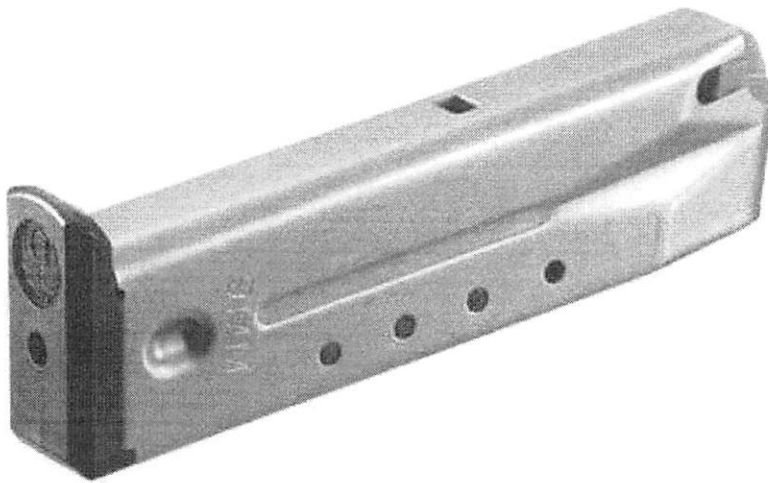

Item Number: 90233

Review Average: ★★★★★

Number of Reviews: 6

[View Reviews \(https://shopruger.com/P-Series-9mm-15-Round-Magazine/productinfo/90233/#reviews\)](https://shopruger.com/P-Series-9mm-15-Round-Magazine/productinfo/90233/#reviews) | [Review this item \(writeReview.asp?number=90233\)](#)

\$42.95

Out of Stock

Quantity

- 1 +

I am a US Citizen or a Resident Alien.

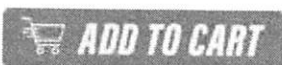

### Detailed Description

P89 (Serial No. 304-70000 & Above), P93, P94, P95™ pistols & PC9 Carbine. Stainless steel, 15-Round, 9mm magazine.

*15-round magazines are not available in all states and locales. Ruger cannot bill to or ship 15-round magazines to the following states and cities: California; Boulder, Colorado, Connecticut, Hawaii, Illinois, Maryland, Massachusetts, New Jersey, New York, Rhode Island, Vermont, Washington State, Washington DC. DO NOT ORDER THIS PRODUCT if you live in these locations.*

Genuine Ruger® Factory Accessory. NOTE: This magazine does NOT fit the PC Carbine™.

*WARNING: Discharging firearms in poorly ventilated areas, cleaning firearms, or handling ammunition may result in exposure to lead and other substances known to the State of California to cause birth defects, reproductive harm, and other serious physical injury. Have adequate ventilation at all times. Wash hands thoroughly after exposure.*

Product Reviews  
[number=90233](#)

[Click here to review this item \(https://shopruger.com/writeReview.asp?number=90233\)](https://shopruger.com/writeReview.asp?number=90233)

★★★★★

Great Job RUGER!

5/27/2019

Sent in a Mag to Ruger! Spring was broken! They replaced it no questions! I bought 2 from Pro-Mag warehouse and they are not even close to the QUALITY..... Im Buying replacements as soon as POSSIBLE!

- Bill Donoho, MO

★★★★☆

Just a teeny bit disappointed

4/4/2019

I would have given 5 stars but I did not get my discount and the one I received looked used. It had some gummy stuff on it and appears to have been stored in a leather pouch or something similar. But it functions as designed. So other than not getting the discount I'm okay with it. It works. That's the main thing.

- Don, TN

★★★★☆ **Good magazine** 3/13/2019  
Bought two of these for my P-94. Work ok but I could only get 14 bullets instead of 15 into them.

★★★★★ **Magged Up** 2/12/2018  
I've purchased one of these for a P95. It works flawlessly every time I go to the range. I plan on buying two more.

- Chuck, LA

★★★★★ **Perfect accessory for the P series** 1/18/2017  
I have purchased several of these and had no issues with any of them. The springs are a little on the stiff side but they get easier to load after usage. I recommend them for sure.

- Gary Fagg, NC

★★★★★ **Great magazine** 10/16/2014  
This is a very sturdy and well made magazine, as one would expect with a Ruger product. The spring was seriously stiff when purchased, but once broken in it is easy to load. Also I have left the magazine fully loaded for over a year and it has yet to lose any elasticity in the spring. Never had any malfunctions and the mag feeds flawlessly.

- Harry, FL





(Top to Bottom) Kel-Tec SUB-2000—9 mm Luger, Ruger PC Carbine—.40 S&W, Angstadt Arms/Macon Armory—10 mm Auto, Heckler & Koch USC—.45 ACP  
Holly Marcus

The idea of pairing a handgun and a rifle around a common cartridge is an American tradition. Some of the earliest, self-contained-cartridge, repeating firearms, such as the Henry rifle, used a pistol-size chambering. The short overall length of these cartridges allowed plenty of rounds to be stacked within a tubular magazine, and their low power wasn't overly taxing on the locking mechanisms of early repeaters. Colt, Smith & Wesson and many other manufacturers would eventually offer revolvers chambered in .44 Henry rimfire.

The system had its advantages in the frontier days of the republic, with revolvers made by Colt, Merwin Hulbert and Remington using the same cartridges as rifle designs by Marlin, Remington and Winchester. The lawman or settler had a single supply of cartridges for both his rifle and handgun. The handgun provided a conveniently carried arm, while the longer barrel of the carbine gave slightly more power out of the same cartridge, along with the increased accuracy, range and capacity of a longarm.

In the 20th century, pistol-size cartridges were adapted to designs beyond the traditional lever-action and revolvers. One of the earliest American sporting semi-automatic rifles was the Winchester Model 1905. Its simple blowback action fired what was basically a pistol cartridge with a straight-wall case that launched a .32-cal., 165-gr. bullet to just under 1400 f.p.s. from its 22" barrel—very close to the performance I got from the modern .40 S&W rifle I tested here.

The past decade has seen a resurgence in the semi-automatic form of what is now known as "pistol-caliber carbines" (PCCs). These newer firearms have often taken things one step further, by adding compatibility with not only a pistol's ammunition, but also its feeding device. Glock magazines have become the predominant choice, but for nearly every popular semi-automatic handgun there is a rifle that uses the same magazine.

The 16" barrel that most PCCs use stretches the performance of pistol cartridges. For this evaluation, I compared the ballistics of the same cartridge fired from one of our test carbines and a "service-size" handgun. The results are shown in the accompanying table (p. 74). The extra 11.5" of barrel netted a velocity gain of between 13 and 19 percent and a gain in muzzle energy of between 27 and 40 percent.

To survey the current PCC world, I looked at four very different long guns, each of which highlights a unique aspect of the market as well as the four most popular chamberings for semi-automatic PCCs.



**Kel-Tec SUB-2000—9 mm luger**

One advantage of pistol-caliber carbines is that they offer an affordable option for a self-defense long gun, with companies such as Hi-Point and Kel-Tec selling PCCs for less than the cost of a base-model AR. PCCs provide a savings on ammunition as well, since, in a normal market, cartridges such as 9 mm Luger are less expensive than rifle cartridges, allowing for more practice time on the range.

Kel-Tec's take on the PCC is to give it a folding format. The company started with the SUB-9 in 1997 and followed up with the SUB-2000 in 2001. Like its predecessor, the SUB-2000 uses a blowback action, wherein the bolt operates in a metal tube that functions as both the receiver and the mounting point for the stock. Pulling down on the trigger guard lets the rifle hinge in the middle and fold in half to the length of its 16.25" barrel. A catch at the heel of the buttstock unlocks the rifle so that it can be folded back into action. With a weight just under 4 lbs., 8 ozs., and a length under 31" when ready to fire, the SUB-2000 was the lightest and most compact of the PCCs I tested—an ideal size for being tucked into a backpack or survival bag.

The SUB-2000, available in 9 mm Luger and .40 S&W, is in its second generation, with updates including molded-in rails on the top and bottom of the fore-end, as well as M-Lok slots. Other updates include a buttstock adjustable for length of pull and a threaded muzzle. With its affordable price and unique features, the SUB-2000 has become one of the most popular PCCs, a fact affirmed by the size of the rifle's aftermarket support.

<b>KEL-TEC SUB-2000 SHOOTING RESULTS (50 YDS.)</b>					
<b>9 MM LUGER CARTRIDGE</b>	<b>VEL. @ 10' (F.P.S.)</b>	<b>ENERGY (FT.-LBS.)</b>	<b>GROUP SIZE (INCHES)</b>		
			<b>SMALLEST</b>	<b>LARGEST</b>	<b>AVERAGE</b>
<b>FEDERAL PREMIUM PUNCH 124-GR. JHP</b>	1339 AVG. 28 SD	494	1.32	2.35	1.86
<b>FEDERAL SYNTECH PCC 130-GR. TSJ</b>	1127 AVG. 9 SD	367	1.67	2.55	2.02
<b>WINCHESTER FORGED 115-GR. FMJ</b>	1318 AVG. 21 SD	444	2.19	2.54	2.33
<b>AVERAGE EXTREME SPREAD</b>					<b>2.07</b>

NOTES: MEASURED AVERAGE VELOCITY FOR 10 SHOTS OVER A COMPETITION ELECTRONICS PROCHRONO DIGITAL CHRONOGRAPH AT 10 FT. ACCURACY RESULTS FOR FIVE CONSECUTIVE, FIVE-SHOT GROUPS AT 50 YDS. FROM A CALDWELL MATRIX REST. TEMPERATURE: 57° F. HUMIDITY: 68%. ABBREVIATIONS: FMJ (FULL METAL JACKET), JHP (JACKETED HOLLOW POINT), PCC (PISTOL CALIBER CARBINE), SD (STANDARD DEVIATION), TSJ (TOTAL SYNTHETIC JACKET).

column, metal-body pistol magazines. These include the Beretta 92, CZ 75/85, Canik TP9, Smith & Wesson Model 59-series and M&P fullsize, and SIG Sauer P320 and P226, by simply switching the magazine catch.

### KEL-TEC SUB-2000 MULTI-MAG

MANUFACTURER: KEL-TEC CNC INDUSTRIES, INC. (DEPT. AR), 1505 COX ROAD, COCOA, FL 321926; (321) 631-0068; KELTECWEAPONS.COM

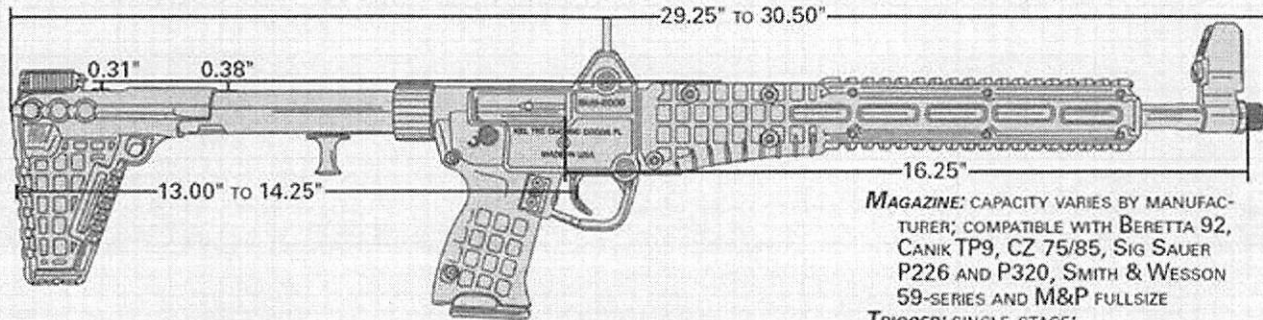

**ACTION TYPE:** BLOWBACK-OPERATED,  
SEMI-AUTOMATIC, CENTER-FIRE RIFLE  
**CHAMBERING:** 9 MM LUGER  
**RECEIVER:** STEEL  
**STOCK:** POLYMER

**BARREL:** CHROME-MOLY STEEL, MUZZLE  
THREADED 1/2X28 TPI; SIX-GROOVE,  
1:10" RH TWIST  
**SIGHTS:** FULLY ADJUSTABLE FRONT POST,  
APERTURE REAR

**MAGAZINE:** CAPACITY VARIES BY MANUFACTURER; COMPATIBLE WITH BERETTA 92, CANIK TP9, CZ 75/85, SIG SAUER P226 AND P320, SMITH & WESSON 59-SERIES AND M&P FULLSIZE

**TRIGGER:** SINGLE-STAGE;  
8-LB., 13-OZ. PULL

**WEIGHT:** 4 LBS., 7 OZS.

**ACCESSORIES:** OWNER'S MANUAL, MAGAZINE CATCH STARTER KIT

**MSRP:** \$556

### Traditionalist Favorite

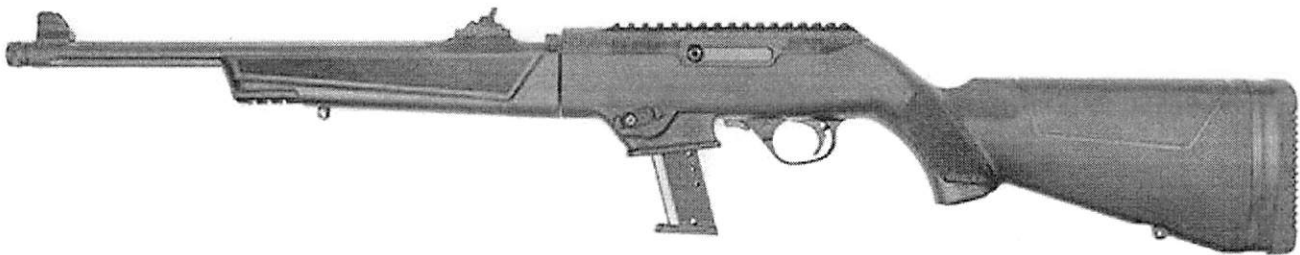

### Ruger PC Carbine—.40 S&W

The first rifle made by Sturm, Ruger & Co. was the 44 Carbine. Introduced in 1961, it was a semi-automatic rifle chambered for a revolver cartridge (.44 Mag.) that fed from a tubular magazine. Like the Winchester 1905 of a half-century prior, the Ruger Carbine cut a traditional profile with its wood stock and blued metal.

Ruger never really got out of the "rifle-chambered-in-a-handgun-cartridge" market, offering pistol chamberings in everything from its No. 3 single-shot to its Model 77 bolt-action. In 1996, it re-entered the semi-automatic PCC world with its line of "Police Carbines." The PC9 (9 mm Luger) and PC40 (.40 S&W) used magazines from the company's P-series pistols, and were manufactured for a decade.

In 2018, Ruger introduced its new, and appropriately named, PC Carbine, in both 9 mm Luger (February 2018, p. 42) and .40 S&W. The PC Carbine I tested was chambered in the latter. While handgun options in .40 S&W are dwindling these days, the cartridge is being kept alive in the PCC world by companies such as Just Right, CMMG, Kel-Tec, KRISS USA, Hi-Point and TNW.

While the PC Carbine somewhat maintains the traditional look of a big 10/22, it is packed with modern features that make it versatile. Machined into its aluminum receiver is a Picatinny rail for mounting optics. Its magazine release and charging handle are reversible. The carbine's fluted barrel is capped with a threaded muzzle. The polymer stock has molded-in sling points and a short section of universal rail on the forearm, and the length of pull is adjustable with three provided spacers. The PC Carbine utilizes a takedown system similar to that used in Ruger's takedown 10/22. A lever in the fore-end unlocks the barrel to twist free of the action, making for a package little more than 20" in length. It comes supplied with a magazine from the Ruger's SR/Security-series pistols and with an adapter to use Glock magazines (an adapter for Ruger American magazines is available as an accessory).



.40 S&W CARTRIDGE	VEL. @ 10' (F.P.S.)	ENERGY (FT.-LBS.)	GROUP SIZE (INCHES)		
			SMALLEST	LARGEST	AVERAGE
<b>AGUILA 180-GR. FMJ</b>	1155 AVG. 26 SD	533	1.72	2.54	2.18
<b>FEDERAL PREMIUM PUNCH 165-GR. JHP</b>	1245 AVG. 23 SD	568	1.64	1.94	1.80
<b>PMC BRONZE 165-GR. JHP</b>	1089 AVG. 21 SD	434	1.23	2.11	1.71
<b>AVERAGE EXTREME SPREAD</b>					1.90

NOTES: MEASURED AVERAGE VELOCITY FOR 10 SHOTS OVER A COMPETITION ELECTRONICS PROCHRONO DIGITAL CHRONOGRAPH AT 10 FT. ACCURACY RESULTS FOR FIVE CONSECUTIVE, FIVE-SHOT GROUPS AT 50 YDS. FROM A CALDWELL MATRIX REST. TEMPERATURE: 66° F. HUMIDITY: 63%. ABBREVIATIONS: FMJ (FULL METAL JACKET), JHP (JACKETED HOLLOW POINT), SD (STANDARD DEVIATION).

A PCC in a more traditional form gives an option to those looking for a semi-automatic rifle for plinking or self-defense in states that restrict certain firearm features (the PC Carbine is available in a version with a 10-round magazine and non-threaded barrel). Combining classic lines with modern conveniences, the Ruger PC Carbine proves that "traditional" does not have to mean "primitive."

**RUGER PC CARBINE .40 S&W**

MANUFACTURER: STURM, RUGER & CO., INC. (DEPT. AR), 411 SUNAPEE ST., NEWPORT, NH 03773; (336) 949-5200; RUGER.COM

**ACTION TYPE:** BLOWBACK-OPERATED, SEMI-AUTOMATIC, CENTER-FIRE RIFLE  
**CHAMBERING:** .40 S&W  
**RECEIVER:** 7075-T6 ALUMINUM ALLOY; HARD-ANODIZED

**STOCK:** POLYMER  
**BARREL:** COLD-HAMMER-FORGED, CHROME-MOLY STEEL, MUZZLE THREADED 9/16X 24TPI; SIX-GROOVE 1:16" RH TWIST

**MAGAZINE:** 15-ROUND DETACHABLE BOX; GLOCK MAGAZINE ADAPTER INCLUDED  
**SIGHTS:** BLADE FRONT, FULLY ADJUSTABLE GHOST-RING APERTURE REAR  
**TRIGGER:** SINGLE-STAGE; 6-LB., 4-OZ. PULL  
**WEIGHT:** 6 LBS. 12 OZS.  
**ACCESSORIES:** OWNER'S MANUAL, STOCK SPACERS, HEX WRENCHES, LOCK  
**MSRP:** \$649

Semi-Automatic Subgun



Heckler & Koch USC—.45 ACP

Beretta CX4 Storm, CZ Scorpion, FN PS90, Kalashnikov USA KR9, KRISS Vector, PTR9R, SIG Sauer MPX and Thompson Model 1927A1. These firearms have the rugged simplicity and proven reliability that comes from their military lineages. This pedigree comes at a price, as they also tend to be the more expensive firearms on the PCC market, and typically use their own proprietary magazines.

In 1999, Heckler & Koch released its UMP (Universal Machine Pistol) submachine gun. It differed from the company's legacy MP5 in several ways. It replaced metal with polymer in many areas, including the magazine and receiver, to reduce weight and cost. The MP5 rear diopter sight was changed to a simple adjustable rear sight with both aperture and open-notch leaves. The UMP also dispensed with H&K's famous roller-delayed-blowback action and used a simple blowback mechanism. A modular design, the UMP is made in 9 mm Luger, .40 S&W and .45 ACP, and the basic firearm has the ability to be converted to any of the three chamberings by swapping barrel, magazine and bolt.

The following year, the company introduced its Universal Self-loading Carbine (USC), a semi-automatic-only version of the UMP for civilians. Available only in .45 ACP, the USC was in production until 2013. Due to popular demand, in 2018 it was re-introduced by H&K as a "limited production" item. Beyond the fact that it sports a 16" barrel and is semi-automatic-only, the USC has several other changes from its UMP sibling so that it can be manufactured in Germany and imported into the United States. The stock is fixed and of a one-piece "thumbhole" configuration. The rifle's 10-round magazine holds its cartridges in a single stack and is not compatible with UMP magazines.

### HECKLER & KOCH USC SHOOTING RESULTS (50 YDS.)

<b>.45 ACP CARTRIDGE</b>	<b>VEL. @ 10' (F.P.S.)</b>	<b>ENERGY (FT.-LBS.)</b>	<b>GROUP SIZE (INCHES)</b>		
			<b>SMALLEST</b>	<b>LARGEST</b>	<b>AVERAGE</b>
<b>FEDERAL PREMIUM PUNCH 230-GR. JHP</b>	946 Avg. 23 SD	457	1.96	2.78	2.54
<b>HORNADY AG 185-GR. XTP</b>	1132 Avg. 16 SD	526	2.75	3.25	3.00
<b>WINCHESTER USA READY 230-GR. FMJ</b>	1000 Avg. 11 SD	511	2.13	2.84	2.47
<b>AVERAGE EXTREME SPREAD</b>					<b>2.67</b>

NOTES: MEASURED AVERAGE VELOCITY FOR 10 SHOTS OVER A COMPETITION ELECTRONICS PROCHRONO DIGITAL CHRONOGRAPH AT 10 FT. ACCURACY RESULTS FOR FIVE CONSECUTIVE, FIVE-SHOT GROUPS AT 50 YDS. FROM A CALDWELL MATRIX REST. TEMPERATURE: 67° F. HUMIDITY: 80%. ABBREVIATIONS: AG (AMERICAN GUNNER), FMJ (FULL METAL JACKET), JHP (JACKETED HOLLOW POINT), SD (STANDARD DEVIATION), XTP (EXTREME TERMINAL PERFORMANCE).

PCCs based on submachine gun designs offer civilians a well-engineered rifle with battle-proven credentials. In the case of the H&K USC, modern European design combines with a classic American handgun cartridge.

IMPORTER: HECKLER & KOCH USA (DEPT. AR), 5675 TRANSPORT BLVD., COLUMBUS, GA 31907; (706) 568-1906; HK-USA.COM



**MANUFACTURER:** HECKLER & KOCH GmbH,  
(GERMANY)

**ACTION TYPE:** BLOWBACK-OPERATED,  
SEMI-AUTOMATIC, CENTER-FIRE RIFLE  
**CHAMBERING:** .45 ACP

**RECEIVER:** POLYMER  
**STOCK:** POLYMER

**BARREL:** COLD-HAMMER-FORGED, CHROME-MOLY STEEL; SIX-GROOVE, POLYGONAL  
1:16" RH TWIST

**MAGAZINE:** 10-ROUND DETACHABLE BOX

**TRIGGER:** TWO-STAGE; 8-LB., 4-OZ. PULL

**SIGHTS:** POST FRONT; APERTURE/OPEN-NOTCH,  
FLIP-UP, FULLY ADJUSTABLE REAR

**WEIGHT:** 6 LBS., 7 OZS.

**ACCESSORIES:** OWNER'S MANUAL, EXTRA  
MAGAZINE, SOFT CASE, LOCK

**MSRP:** \$1,499

### Glock-Mag AR With A Twist



### Angstadt Arms/Macon Armory—10 mm auto

In 1982, Colt introduced a 9 mm submachine gun version of the M16. Three years later, it brought out a semi-automatic 16"-barreled carbine version, and the AR-15 pistol-caliber carbine was born. They were soon joined by AR-15 innovator Olympic Arms, which expanded the pistol-caliber-AR market beyond 9 mm to include .40 S&W, .45 ACP and 10 mm Auto. Though Olympic started out using modified Uzi magazines in its PCCs, by the late 1990s it was making AR-15 lowers compatible with common pistol magazines, including the Glock.

While the 10 mm Auto cartridge has traditionally been somewhat of a rarity in rifles, the recent resurgence in interest in the cartridge has crossed over into the PCC world. Pistol-caliber carbines in 10 mm Auto are now available from companies such as CMMG, KRISS USA, Just Right, TNW and Hi-Point. A 16" barrel wrings the maximum performance out of the high-strung 10 mm Auto, with several of the cartridges I tested producing more than 700 ft.-lbs. of muzzle energy. A PCC in 10 mm takes a pistol cartridge into the realm of close-range hunting for medium-size game.

In AR-15 rifle form, though, the 10 mm is still uncommon. While the aforementioned 10 mm PCCs have plenty of room in their receivers to house a bolt with enough mass to handle the pressures developed by the 10 mm cartridge, the AR-15 presents its own problems when trying to fit a blowback system within the confines of a 5.56 mm-sized receiver. Even when chambered in 9 mm, an AR-15-type rifle must be adapted to a blowback action, with extra weight added to the bolt, a reinforced hammer and heavier buffer.

A solution to this problem is offered by Georgia-based [Macon Armory](#). Known for its AR-45 .45 ACP AR-15 conversions, Macon builds an upper chambered in 10 mm Auto that is a locked-breech design with direct-impingement (DI) gas operation. Starting with a standard upper receiver, that includes a forward assist, a case deflector and a dustcover, Macon modifies a standard AR bolt and carrier to accommodate the 10 mm cartridge. Under the upper's free-float handguard, a low-profile gas block routes a custom-length gas tube back into the receiver. The system works exactly like a standard rifle-caliber AR-15. When a cartridge is fired, a small amount of gas is bled off the barrel. It travels back the gas tube into the receiver where it causes the carrier to move rearward, unlocking the multi-lug, rotating bolt.



recommends pairing its upper with an [Angstadt Arms](#) lower. We followed its advice, sourcing Angstadt's large-frame, Glock-magazine-compatible 1045 lower receiver. The billet receiver comes stripped, except for its proprietary parts, including the magazine release and bolt hold-open lever. We completed the build with a standard AR-15 lower parts kit and a VLTOR EMOD stock. Because of its direct-impingement operation, the Macon Armory upper is compatible with standard AR hammers and a carbine-weight buffer system.

**ANGSTADT ARMS/MACON ARMORY SHOOTING RESULTS (50 YDS.)**

10 MM AUTO CARTRIDGE	VEL. @ 10' (F.P.S.)	ENERGY (FT.-LBS.)	GROUP SIZE (INCHES)		
			SMALLEST	LARGEST	AVERAGE
<b>BUFFALO BORE HEAVY 200-GR. FMJ</b>	1268 Avg. 18 Sd	714	1.75	2.37	2.09
<b>CCI BLAZER BRASS 180-GR. FMJ</b>	1322 Avg. 13 Sd	698	1.09	1.84	1.53
<b>FEDERAL PREMIUM HST 200-GR. JHP</b>	1151 Avg. 18 Sd	588	1.58	2.24	1.84
<b>AVERAGE EXTREME SPREAD</b>					1.82

NOTES: MEASURED AVERAGE VELOCITY FOR 10 SHOTS OVER A COMPETITION ELECTRONICS PROCHRONO DIGITAL CHRONOGRAPH AT 10 FT. ACCURACY RESULTS FOR FIVE CONSECUTIVE, FIVE-SHOT GROUPS AT 50 YDS. FROM A CALDWELL MATRIX REST. TEMPERATURE: 67° F. HUMIDITY: 72%. ABBREVIATIONS: FMJ (FULL METAL JACKET), JHP (JACKETED HOLLOW POINT), Sd (STANDARD DEVIATION).

Pistol-caliber AR-15s bring many advantages to the PCC world. They combine the familiarity of America's most popular rifle with DIY-friendly aftermarket support. Toss in the 10 mm cartridge and our [Macon Armory/Angstadt Arms](#) build pushes AR PCC performance to the max.

**ANGSTADT ARMS/MACON ARMORY 10 MM DI**

MANUFACTURER: ANGSTADT ARMS (DEPT. AR), 701 ATANDO AVE., SUITE E, CHARLOTTE, NC 28206; (704) 200-9352; ANGSTADTARMS.COM  
 MACON ARMORY (DEPT. AR), 2970 McMANUS ROAD, MACON, GA 31220; (478) 474-2990; MACONARMORY.COM

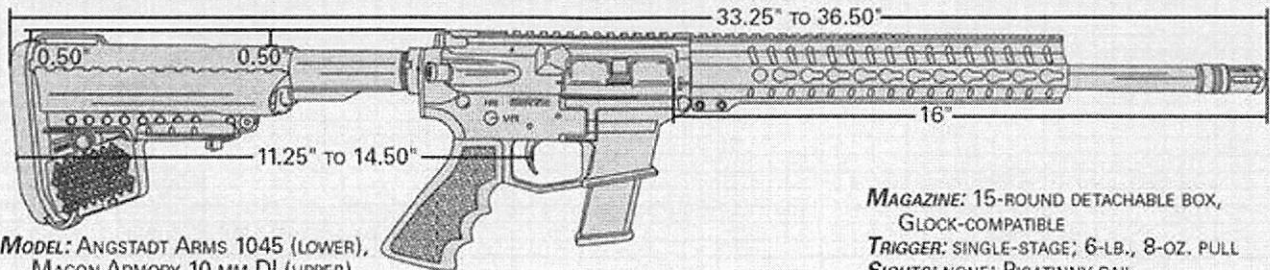

MODEL: ANGSTADT ARMS 1045 (LOWER),  
 MACON ARMORY 10 MM DI (UPPER)  
 ACTION TYPE: GAS-OPERATED,  
 SEMI-AUTOMATIC, CENTER-FIRE RIFLE  
 CHAMBERING: 10 MM AUTO  
 RECEIVER: 7075-T6 ALUMINUM ALLOY;  
 HARD-ANODIZED

STOCK: POLYMER  
 BARREL: 4140 CHROME-MOLY STEEL; MUZZLE  
 THREADED 5/8x24 TPI; SIX-GROOVE,  
 1:16" RH TWIST

MAGAZINE: 15-ROUND DETACHABLE BOX,  
 GLOCK-COMPATIBLE  
 TRIGGER: SINGLE-STAGE; 6-LB., 8-OZ. PULL  
 SIGHTS: NONE; PICATINNY RAIL  
 WEIGHT: 6 LBS., 10 OZS.  
 ACCESSORIES: N/A  
 MSRP: \$925 (UPPER), \$279 (LOWER),  
 \$140 (LOWER PARTS), \$115 (STOCK),  
 TOTAL: \$1,459

**PISTOL-CALIBER CARBINE TEST – RIFLE VS. PISTOL VELOCITY AND ENERGY COMPARISON**

CARTRIDGE	FIREARM	BARREL LENGTH (INCHES)	VEL. @ 10' (F.P.S.)	VELOCITY DIFFERENCE	ENERGY (FT.-LBS.)	ENERGY DIFFERENCE
9 MM LUGER WINCHESTER FORGED 115-GR. FMJ	GLOCK MODEL 17	4.5	1146 AVG.		336	
	KEL-TEC SUB-2000	16.25	1318 AVG.	172 F.P.S. (15.01%)	444	108 FT.-LBS. (32.14%)
.40 S&W AGUILA 180-GR. FMJ	SIG SAUER P226	4.4	1025 AVG.		421	
	RUGER PC CARBINE	16.20	1155 AVG.	130 F.P.S. (12.68%)	533	112 FT.-LBS. (26.60%)
10 MM AUTO CCI BLAZER BRASS 180-GR. FMJ	GLOCK MODEL 20	4.6	1115 AVG.		497	
	ANGSTADT ARMS/MACON ARMORY DIAR-15	16.00	1322 AVG.	207 F.P.S. (18.57%)	698	201 FT.-LBS. (40.44%)
.45 ACP WINCHESTER USA READY 230-GR. FMJ	GLOCK MODEL 21	4.6	845 AVG.		365	
	HECKLER & KOCH USC	16.00	1000 AVG.	155 F.P.S. (18.34%)	511	146 FT.-LBS. (40.00%)

MEASURED AVERAGE VELOCITY FOR 10 ROUNDS USING A COMPETITION ELECTRONICS PROCHRONO DIGITAL CHRONOGRAPH.

**Conclusion**

Nearly 150 years after Colt decided to chamber its famed Frontier Six-Shooter in the .44-40 round used by Winchester's Model 1873, pistol-caliber carbines still offer many of the same advantages. Pistol-caliber long guns are an affordable, compact, lightweight and low-recoiling option when compared with carbines or rifles chambered for rifle cartridges. In addition, they offer greater effective accuracy and increased power over a handgun chambered for the same cartridge. In times when some





...development of hunting and target sports and some handgun champions and some of our most accomplished shooters.

home defense, plinking or competitive shooting, pistol-caliber carbines represent a practical choice.

One rifle, one handgun, one cartridge.

© Copyright 2023 National Rifle Association

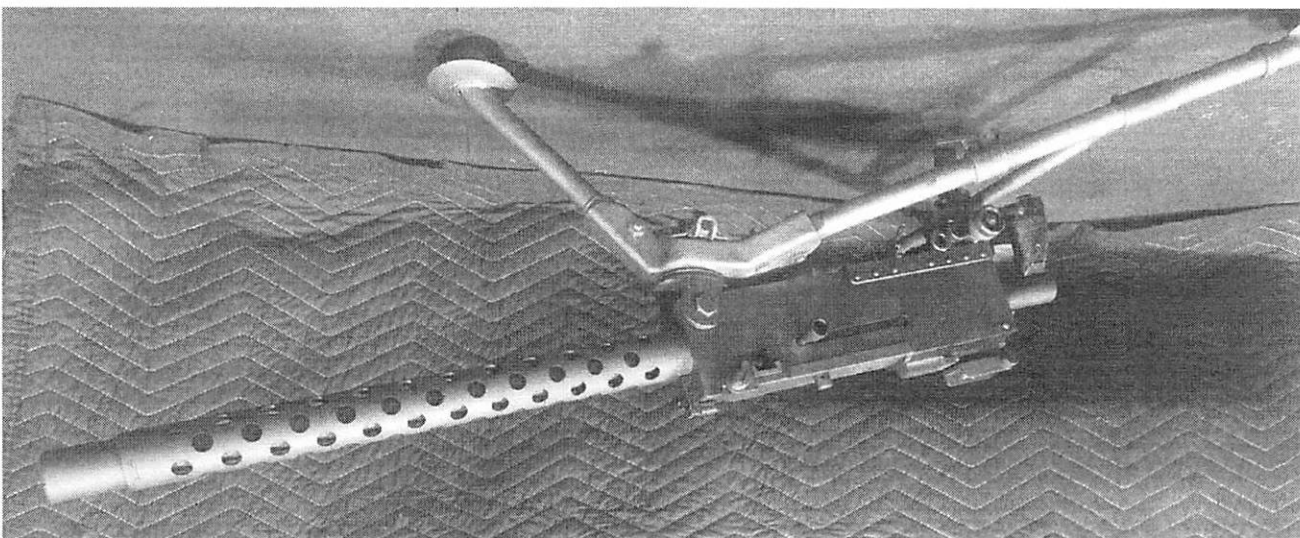
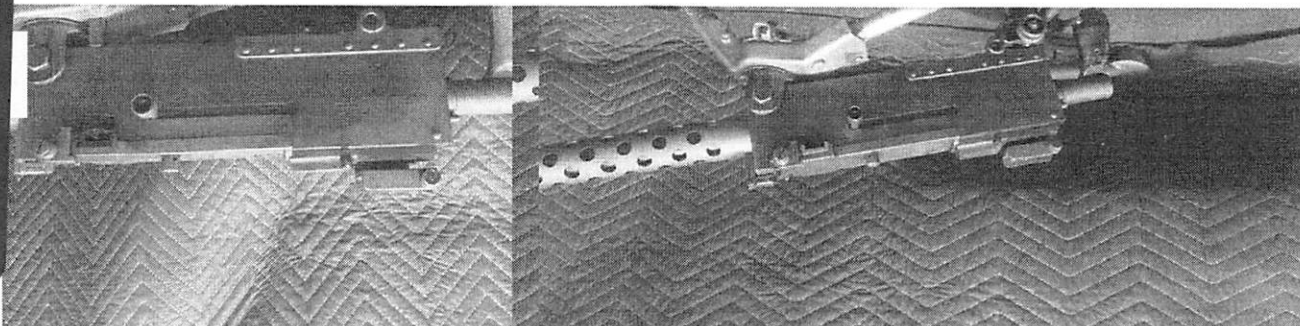
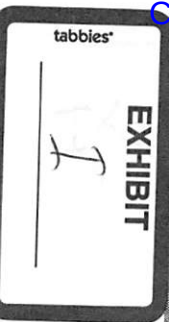

1919A4 \$ 4,500.00 1919A6 \$ 6,000.00

One of our best sellers is the Browning 1919A4-a6. These semi-auto belt fed guns are chambered in 30-06 or 308 what ever you prefer. All our guns are build here at Ice House Mfg, test fired at the range, and have a new parkerizing finish on them. These guns are very reliable to have a great day at the range. (Tri-pod not included) FFL is required

# 1919a4-a6 for sale



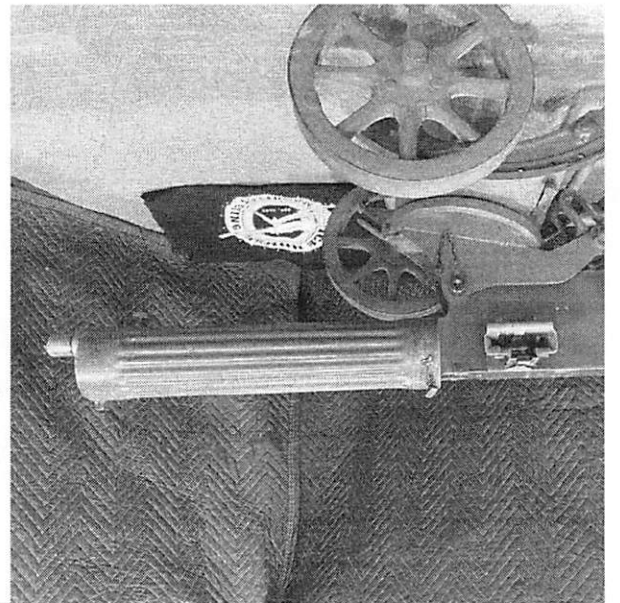
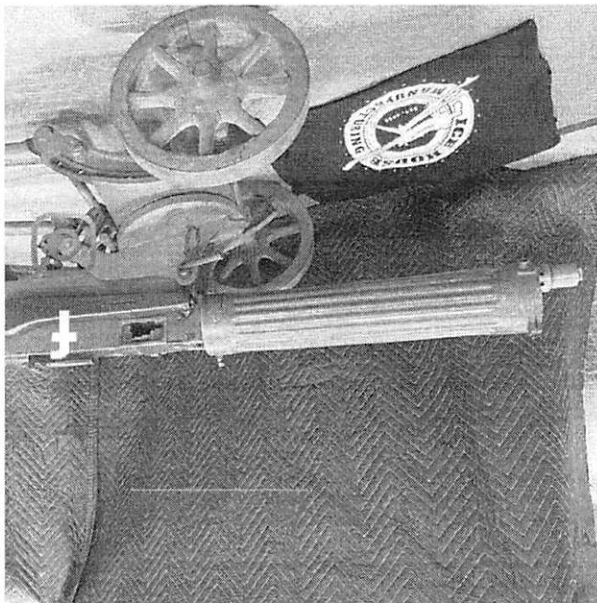

Maxim call  
for availability

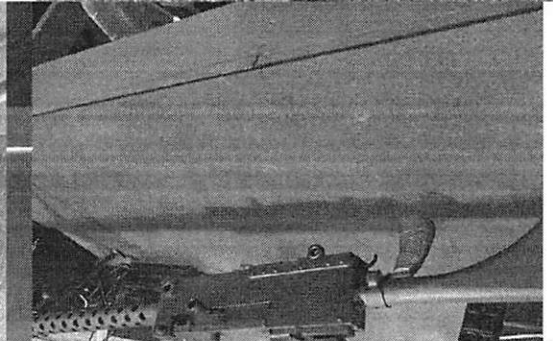
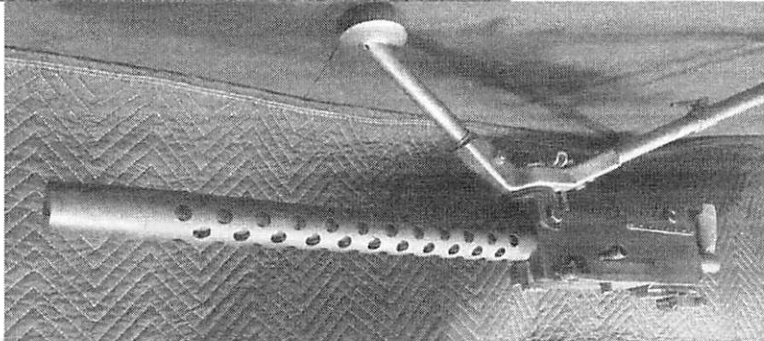

CONTACT

HOME SPECIAL FEATURE GUN BUILDS SERVICES SHOP 1919A4 FOR SALE ABOUT

