

# Group Exhibit A

Page 1

IN THE UNITED STATES DISTRICT COURT  
 FOR THE SOUTHERN DISTRICT OF ILLINOIS

CALEB BARNETT, et al., )  
 Plaintiffs, )  
 ) Case No. 3:23-cv-209-SPM  
 vs. )  
 ) Designated Lead Case  
 KWAME RAOUL, et al., )  
 Defendants. )

---

DANE HARREL, et al., )  
 Plaintiffs, )  
 ) Case No. 3:23-cv-141-SPM  
 vs. )  
 )  
 KWAME RAOUL, et al., )  
 Defendants. )

---

JEREMY W. LANGLEY, et al., )  
 Plaintiffs, )  
 ) Case No. 3:23-cv-192-SPM  
 vs. )  
 )  
 KWAME RAOUL, et al., )  
 Defendants. )

---

FEDERAL FIREARMS LICENSEES OF )  
 ILLINOIS, et al., )  
 Plaintiffs, )  
 ) Case No. 3:23-cv-215-SPM  
 vs. )  
 )  
 JAY ROBERT "JB" PRITZKER, et al., )  
 Defendants. )

VIDEOTAPED DEPOSITION OF MATTHEW WILSON  
 Taken on behalf of the Defendants  
 October 3rd, 2023  
 9:40 a.m. to 1:53 p.m.  
 Jamie Jo Kinder, CCR 842, CSR 084.003306

Page 3

1 IN THE UNITED STATES DISTRICT COURT  
 FOR THE SOUTHERN DISTRICT OF ILLINOIS

2  
 3  
 4 CALEB BARNETT, et al., )  
 Plaintiffs, )  
 5 ) Case No. 3:23-cv-209-SPM  
 vs. )  
 6 ) Designated Lead Case  
 KWAME RAOUL, et al., )  
 7 Defendants. )  
 8 -----)  
 and all related cases. )  
 9  
 10 VIDEOTAPED DEPOSITION OF WITNESS, MATTHEW WILSON,  
 11 produced, sworn, and examined on the 3rd day of October,  
 12 2023, between the hours of 8:00 o'clock in the forenoon and  
 13 5:00 o'clock in the afternoon of that day, at the Office of  
 14 the Illinois Attorney General, 201 West Pointe Drive, Suite  
 15 7, Swansea, IL, before Jamie Jo Kinder, Missouri CCR 842,  
 16 Illinois CSR 084-003306, a Certified Shorthand Reporter  
 17 within and for the State of Illinois, in a certain cause  
 18 now pending in the United States District Court for the  
 19 Southern District of Illinois.  
 20  
 21  
 22  
 23  
 24  
 25

Page 2

1 I N D E X

2 Page

3 EXAMINATION

4 QUESTIONS BY MR. WELLS 8

5 QUESTIONS BY MR. MAAG 140

6 QUESTIONS BY MR. WELLS 156

7 EXHIBITS

8 Deposition Exhibit 1 20

9 Deposition Exhibit 2 33

10 Deposition Exhibit 3 41

11 Deposition Exhibit 4 48

12 Deposition Exhibit 5 55

13 Deposition Exhibit 6 87

14 Deposition Exhibit 7 97

15 Deposition Exhibit 8 115

16 Deposition Exhibit 9 119

17 Deposition Exhibit 10 128

18 Deposition Exhibit 11 131

19

20 (Exhibits retained by the Reporter and attached.)

21 (The material quoted in the transcript was written verbatim

22 as read, and may not be a direct quote from the exhibit.)

23

24

25

Page 4

1 A P P E A R A N C E S

2 For the Plaintiffs Langley, et al.:

3 Mr. Thomas G. Maag  
 MAAG LAW FIRM, LLC  
 4 22 W. Lorena Avenue  
 Wood River, IL 62095  
 5 (618) 216-5291  
 tmaag@maaglaw.com

6

7 For the Defendants Raoul and Kelly:

8 Mr. Christopher G. Wells  
 Ms. Gretchen Helfrich  
 9 OFFICE OF THE ATTORNEY GENERAL  
 100 W. Randolph Street  
 10 Chicago, IL 60601  
 (312) 814-3000  
 11 christopher.wells@ilag.gov

12

13 For Cole Shaner:

14 Mr. Keith Hill (via Zoom)  
 HEYL ROYSTER VOELKER & ALLEN  
 15 103 W. Vandalia Street, Suite 100  
 Edwardsville, IL 62025-0467  
 16 (618) 656-4646  
 khill@heyloyster.com

17

18 Also present via Zoom: Mr. John Zimmerman and  
 Ms. Abby Sgro,  
 19 in-house counsel for ISP

20

21 Ms. Jamie Jo Kinder, CCR, CSR  
 Mr. Ken Carden, Videographer

22 LEXITAS LEGAL  
 711 N. Eleventh Street  
 23 St. Louis, MO 63101  
 (800) 280-3376  
 24 https://lexitaslegal.com  
 stl.customerservice@lexitaslegal.com

25

Page 5

1 (Deposition commenced at 9:40 a.m.)  
2 IT IS HEREBY STIPULATED AND AGREED, by and  
3 between counsel for Plaintiffs and counsel for Defendants,  
4 that the videotaped deposition of MATTHEW WILSON may be taken  
5 in shorthand by Jamie Jo Kinder, CCR, CSR, a notary public and  
6 shorthand reporter, and afterwards transcribed into  
7 typewriting; and the signature of the witness is expressly  
8 waived.  
9 \* \* \* \* \*  
10 THE VIDEOGRAPHER: We are on the record.  
11 Today's date is October 3rd, 2023, and the time now is  
12 9:40. This is the video-recorded deposition of Matthew  
13 Wilson in the matter of Caleb Barnett, et al., v Kwame  
14 Raoul, et al., Case No. 3:23-cv-209-SPM in the United  
15 States District Court for the Southern District of  
16 Illinois.  
17 This deposition is being held at 201 West  
18 Pointe Drive. The reporter's name is Jamie Kinder. My  
19 name is Ken Carden. I'm the legal videographer.  
20 Would the attorneys present please introduce  
21 themselves and the parties they represent.  
22 MR. WELLS: Sure. Christopher Wells on behalf  
23 of the State defendants, Mr. Raoul and also Mr. Kelly.  
24 MR. MAAG: Thomas Maag, M-A-A-G, on behalf of  
25 Mr. Wilson and the Langley plaintiffs generally.

Page 6

1 MS. HELFRICH: Gretchen Helfrich on behalf of  
2 the State defendants.  
3 MR. WELLS: And I just note for the record,  
4 that this is actually specific to the Langley v. Kelly  
5 matter.  
6 MR. MAAG: Yes.  
7 MR. WELLS: The motions that plaintiffs have  
8 filed on two of their claims that are specific to the  
9 Langley case.  
10 MR. MAAG: Right, but there are other people  
11 on-line as well.  
12 MR. WELLS: Correct. That's right. And that  
13 case number, just for the record, is 23-cv-192-SPM also in  
14 the Southern District of Illinois.  
15 THE VIDEOGRAPHER: Would the court reporter  
16 please swear in the witness.  
17 (Witness sworn in.)  
18 MR. WELLS: And I just note for the record, so  
19 we're taking this deposition related to the Langley  
20 plaintiffs' motion for summary judgment on their two  
21 vagueness claims. We are reserving our right to  
22 potentially seek an additional deposition if the other  
23 Second Amendment claims in the consolidated Barnett action  
24 come back to the district court at some point. So I just  
25 want to make that note for the record.

Page 7

1 MR. MAAG: You have noted your position for  
2 the record.  
3 MR. WELLS: Understood. And I'd also note  
4 that we have served discovery, some written discovery, on  
5 Mr. Wilson.  
6 MR. MAAG: I think it's due tomorrow  
7 technically.  
8 MR. WELLS: Well, I think it was due  
9 yesterday. So we served it on September 1st and the rule  
10 would be --  
11 MR. MAAG: You get to add the three days, so  
12 ...  
13 MR. WELLS: Well, regardless, we haven't  
14 received it, but we are proceeding with the deposition --  
15 MR. MAAG: Right.  
16 MR. WELLS: -- absent that. Obviously  
17 reserving our rights with respect to any objections related  
18 to that discovery, et cetera.  
19 MR. MAAG: Sure. I assume you're going to ask  
20 him questions that are --  
21 MR. WELLS: Similar?  
22 MR. MAAG: -- very similar.  
23 MR. WELLS: Yes. Exactly.  
24 \* \* \* \* \*  
25 MATTHEW WILSON,

Page 8

1 of lawful age, being produced, sworn and examined on  
2 behalf of the Defendants, deposes and says:  
3 EXAMINATION  
4 QUESTIONS BY MR. WELLS:  
5 Q Okay. So with that, sorry, to start with some  
6 of that legales. Have you ever been deposed before?  
7 A Yes.  
8 Q When have you been deposed?  
9 A 2009, I believe.  
10 Q Okay. And was that just one time that you  
11 have been deposed?  
12 A I believe so.  
13 Q And what were you -- What kind of case were  
14 you deposed in?  
15 A The -- It was a contract dispute.  
16 Q Okay.  
17 A That's about as simple as I can put it.  
18 Q Understood. And were you a party in that  
19 case?  
20 A The company that I owned was.  
21 Q All right.  
22 MS. SGRO: We can't hear. It cuts out any  
23 time he responds. I don't know if there's not a mic near  
24 him, but we cannot hear anything he says.  
25 MR. MAAG: Just try to speak up.

Page 9

1 MR. WELLS: There's, like, three different  
2 audio systems.  
3 A I didn't realize there was a third.  
4 MR. WELLS: No. It's okay.  
5 MR. MAAG: Matt is soft spoken.  
6 Q (By Mr. Wells) I'm sorry about all of the  
7 technological complication. So I'm just going to go over  
8 some brief ground rules for a deposition. You're under  
9 oath.  
10 A Yes.  
11 Q Just like you are -- like you would be in  
12 court. We have a court reporter here who is taking down  
13 everything that's said in the room, my words, your words.  
14 And to help her out, we're going to ask -- or I'm going to  
15 ask you to wait for me to finish my questions, and I will  
16 also wait for you to finish your answers, just so that she  
17 can get a clean record. If you wouldn't mind, try not to  
18 interrupt me. It will inevitably happen. I will interrupt  
19 you, you will interrupt me. We will try to remind each  
20 other along the way not to do that, just to help the court  
21 reporter out.  
22 When I ask you a question, I'm going to assume  
23 you understand if you answer. If you don't understand the  
24 question, then ask me to clarify it. If -- Mr. Maag, he  
25 may object at various points during the deposition.

Page 10

1 Generally speaking, if he objects, you still need to  
2 answer. If he instructs you not to answer, and there are a  
3 limited number of circumstances in which he can do that, if  
4 he instructs you not to answer, that's a different  
5 situation. But generally speaking, if he objects, you can  
6 still answer.  
7 Let me know if you need a break. You know,  
8 hopefully we can keep it moving pretty quickly here, but if  
9 you need a break to get water, go to the bathroom, just let  
10 me know.  
11 A Thank you for the courtesy.  
12 Q Of course. If there's a question pending, I  
13 will ask that you answer the question pending before we  
14 take the break and then we'll take the break.  
15 A (Witness nods head affirmatively.)  
16 Q And I don't -- This is kind of a probing  
17 question, I apologize for it, but are you on any medication  
18 today that would affect your ability to testify truthfully  
19 and completely?  
20 A No, sir.  
21 Q Are you on any drugs or alcohol that would  
22 impact your ability to testify truthfully?  
23 A No.  
24 Q Okay. This deposition relates to a lawsuit  
25 that you filed challenging the constitutionality of the

Page 11

1 Protecting Illinois Communities Act, Public Act 102-1116.  
2 Throughout the deposition, I'm going to refer to that as  
3 PICA, so P-I-C-A.  
4 A Acronym.  
5 Q Is that okay?  
6 A I just have to remember is all.  
7 Q So when I say PICA -- Again, if you don't  
8 understand, you can ask me. I may also use the number  
9 102-1116.  
10 A Let's just stick with PICA. That would be  
11 easier for my mind.  
12 Q Okay. Understood. Understood. So I'll stick  
13 with PICA. So the reason that we are here today is because  
14 your attorney has filed a motion for summary judgment on  
15 two of the claims in your lawsuit relating to vagueness.  
16 So I'll just ask you to tell me in your own words what you  
17 think is unconstitutionally vague in PICA.  
18 MR. MAAG: I'll just object to the form as  
19 being very broad. Subject to that, go ahead.  
20 A I mean, with my experience on some firearms  
21 and tooling and your definition of 50 BMG, I'm going to  
22 start with the magazine -- or the magazines and the rifles.  
23 There are many rifle/pistol combinations that  
24 I can think of that share magazines. And the way that I  
25 understand PICA is I won't be allowed to possess or

Page 12

1 transfer or buy anything over 15 rounds. And what am I  
2 supposed to do if I have a -- a pistol that shares the same  
3 magazine that a rifle? How are you to tell the difference?  
4 How am I to tell the difference? How am I to know what's  
5 legal?  
6 And then you've made reference to some  
7 tooling. I mean, what is that? I don't understand what  
8 that means. I don't know if you're talking about specific  
9 tools. I don't know if you're talking about Snap-on tools.  
10 I don't know if you're talking about machine tools.  
11 And then there's a reference to registration  
12 of 50 BMG, all the ammunition. I don't know if that's  
13 specific to 50 BMG. I don't know if that's -- that  
14 includes the Smith & Wesson 500. I don't know if that  
15 includes the Beowulf .50. I don't know if that includes  
16 black powder Sabots. And does that mean that I cannot buy  
17 any more? Does that mean that resources are finite once  
18 those are used? Or does that mean if I were to buy more, I  
19 would have to immediately register them?  
20 Q (By Mr. Wells) Okay. So you've -- you've  
21 covered a couple of different topics there. As I  
22 understand it, your attorney filed a motion for summary  
23 judgment on two specific claims. I think you mentioned in  
24 particular the claim related to magazines; right? So what  
25 is the capacity, the magazine capacity, for firearms in



Page 13

1 Illinois that you can still purchase, is that your  
2 understanding of what that claim is?  
3 A Would you repeat that?  
4 Q Can you read it back?  
5 MS. SGRO: Rick, I'm really sorry, but we  
6 can't hear him at all.  
7 MR. WELLS: All right. I've got it right next  
8 to him now.  
9 (The requested portion of the  
10 record read by the reporter.)  
11 A No.  
12 Q (By Mr. Wells) So what is your understanding  
13 of that claim?  
14 A My question is the possession. If I have a  
15 platform, for example, the Beretta 92A, it holds -- my  
16 understanding, the pistol can hold 15 rounds. If I have  
17 the Beretta Cx4 and it's only allowed to have 10 rounds,  
18 and the magazines are completely interchangeable, and I  
19 have both of them in my vehicle and I get pulled over, what  
20 is law enforcement to do?  
21 Q Okay. And one of the other claims that your  
22 attorney has filed a motion for summary judgment on is  
23 vagueness related to the use of the phrase AR-type and  
24 AK-type. Can you tell me what your understanding of that  
25 claim is?

Page 14

1 A That's the problem. I don't understand it  
2 because it looks like -- that you have grouped things such  
3 as the SKS in with the AKs, and I don't understand why  
4 because they don't share -- if you're looking at it from a  
5 factory standpoint, they don't share anything in common,  
6 except for they both have sights and they have triggers.  
7 The rest of it, internal-wise, is two different animals.  
8 It's like comparing a train to an airplane.  
9 Q Okay.  
10 A And then the AR-type is, I think, even more  
11 confusing.  
12 Q Can you just tell me a little bit about your  
13 educational background?  
14 A I have a manufacturing degree from Wabash  
15 Valley College in Mount Carmel.  
16 Q When you say manufacturing degree, is that --  
17 What type of degree is that? Is that a bachelor's,  
18 associate's or --  
19 A It's associate's in science.  
20 Q And what other -- Are there other degrees that  
21 you have? Did you graduate?  
22 A I have a general in science.  
23 Q Okay. General, when you say general --  
24 A Associate's.  
25 Q Okay. What's your current address?

Page 15

1 A I will give you that off the record.  
2 Q Okay. What's your date of birth?  
3 A September 3rd, 1978.  
4 Q Are you currently employed?  
5 A Yes.  
6 Q Who is your employer?  
7 A Myself.  
8 Q When you say yourself, do you have a business  
9 that's registered?  
10 A I have more than one.  
11 Q Okay. And what are those? What's the nature  
12 of those businesses?  
13 A Oil and gas and farming.  
14 Q Have you ever served in the military?  
15 A No.  
16 Q And I don't mean this to be at all insulting,  
17 but this is a legal term. Would you consider yourself a  
18 person of ordinary intelligence?  
19 A With the way the world today is, I don't know  
20 what that means.  
21 Q Understood. Have you ever -- And again, I  
22 don't mean to probe, but --  
23 A Just be blunt. I won't take it personally.  
24 Q No. These are just some of the questions that  
25 we have to ask. Have you ever been convicted of a crime?

Page 16

1 A Can we go off the record for a minute?  
2 MR. MAAG: I mean, I'll interpose an  
3 objection. If your question is a felony or a crime of  
4 moral turpitude, he can go ahead and answer. I mean, if  
5 you're asking about speeding tickets.  
6 Q (By Mr. Wells) No, I'm not asking about  
7 speeding tickets.  
8 A No, I have not.  
9 Q Okay. So misdemeanor or felony?  
10 A No felonies.  
11 Q No felonies. Any misdemeanors?  
12 A I don't think so.  
13 Q Okay. Do you have a FOID card?  
14 A Yes.  
15 Q When did you first obtain a FOID card? If you  
16 don't remember --  
17 A '97, I think.  
18 Q Okay. And you have maintained a FOID card  
19 since then?  
20 A Yes.  
21 Q And when I say FOID card, for the benefit of  
22 the court reporter, it's Firearms Owner's Identification  
23 Card, F-O-I-D. Do you have a concealed carry license in  
24 Illinois?  
25 A I do.

Page 17

1 Q When did you get that license?  
2 A When I applied or when I received the  
3 physical?  
4 Q Well, just when -- Approximately when you  
5 received it.  
6 A I think March of '15.  
7 Q And have you maintained that license since --  
8 A Yes.  
9 Q -- March of 2015? Again, just wait. I know  
10 it's -- Wait for me to get the question out so that she can  
11 get the clean record, if that's okay.  
12 A My bad.  
13 Q No, it's okay. And just -- you mentioned you  
14 in terms of what the state has done. I just want to  
15 clarify for your own purposes. I'm just an attorney  
16 representing a client. I personally didn't, you know,  
17 write the law. Right? So it's not necessarily me in that  
18 sense. Right? So it's the state. I just want to be clear  
19 about that.  
20 MR. MAAG: I wouldn't take credit for it  
21 either.  
22 Q (By Mr. Wells) Do you carry a concealed  
23 handgun in public?  
24 A Yes.  
25 Q And when you carry a concealed firearm in

Page 18

1 public, it is a handgun; right?  
2 A Yes.  
3 Q Do you ever carry a concealed rifle in public?  
4 A I'm not sure that we're allowed to, but I have  
5 not.  
6 Q So is it fair to say your understanding of  
7 your concealed carry license is that --  
8 A Pistols only.  
9 Q Pistols only? You can carry a handgun,  
10 pistols, revolvers, but not a rifle, is that your  
11 understanding?  
12 A That's my understanding.  
13 Q And would that understanding also apply to a  
14 shotgun? You couldn't carry a concealed shotgun in public?  
15 A Let me ask you this. Taurus makes the Judge,  
16 which you can put 410 shotgun shells in, and Smith & Wesson  
17 makes the Governor, which you can put shotgun shells in.  
18 And I do consider those shotguns because they have shotgun  
19 or -- shotgun shot and shells in them.  
20 Q Do you carry those in public?  
21 A No.  
22 Q Okay.  
23 A But I've considered it. I have been dog bit  
24 bicycling a handful of times and I've considered it for  
25 dogs.

Page 19

1 Q Understood. But generally speaking, when you  
2 carry a concealed firearm in public, you're carrying a  
3 handgun?  
4 A Yeah.  
5 Q And what type of handgun do you carry?  
6 A A pistol.  
7 Q And what's the magazine capacity on that  
8 pistol?  
9 MR. MAAG: Presently or prior to this statute  
10 being enacted?  
11 Q (By Mr. Wells) Let's go with presently.  
12 A I think it's nine.  
13 Q Nine?  
14 A Nine rounds.  
15 Q Nine rounds. Prior to this statute being  
16 enacted, what kind of handgun did you carry when you  
17 concealed carry?  
18 A Held 33 rounds.  
19 Q Held 33 rounds?  
20 A (Witness nods head affirmatively.)  
21 Q So since the PICA has gone into effect, you  
22 have switched from a 33-round magazine on your concealed  
23 carry handgun to a nine-round magazine on your concealed  
24 carry handgun; is that right?  
25 A That's correct.

Page 20

1 Q And is it a different pistol that you used to  
2 carry compared to what you carry now?  
3 A Yes, sir.  
4 Q What's the pistol that you carry now?  
5 A Smith & Wesson 609.  
6 Q And when you concealed carry now, now that  
7 PICA is in effect, you understand that that handgun has to  
8 have a magazine that's 15 rounds or less?  
9 A That's my understanding, yes.  
10 Q What firearms do you currently own?  
11 MR. MAAG: Objection. Overbroad. Irrelevant.  
12 Q (By Mr. Wells) Well, if he's --  
13 A I refuse to answer that.  
14 Q Okay. On what basis are you refusing to  
15 answer?  
16 A I'm going to go with Fifth Amendment.  
17 Q Okay. So you're asserting your Fifth  
18 Amendment right to not answer a question about what  
19 firearms you currently have?  
20 A No. I think it's none of your business what I  
21 own.  
22 Q Okay. You mentioned in your declaration --  
23 I'm going to go ahead and hand this to you. We will mark  
24 this as Exhibit 1.  
25 (Deposition Exhibit No. 1 marked for

Page 21

1 identification.)  
2 MR. WELLS: Do you want a sticker, Tom?  
3 MR. MAAG: I don't care about a sticker.  
4 A He can have my sticker.  
5 Q (By Mr. Wells) So I have just marked as  
6 Exhibit 1 a document titled Statement Pursuant [sic],  
7 which I think is pursuant, to 28 USC 1746. Do you  
8 recognize this document?  
9 A I do.  
10 Q What is it?  
11 A It's a list outlining what we don't  
12 understand.  
13 Q Okay. Is that your signature at the bottom of  
14 this document?  
15 A Yep.  
16 Q Did you prepare this document?  
17 A With the help of my attorney.  
18 Q I would like to direct your attention to  
19 paragraph six. In paragraph six you wrote, "I personally  
20 own at least one rifle that uses the same magazine as at  
21 least one pistol I own uses. The magazines for the rifle  
22 and the pistol are made by the same company and are  
23 indistinguishable from either other as they are identical."  
24 What firearms are you referring to in that  
25 paragraph?

Page 22

1 A I can't recall the pistol, but I can recall  
2 the other one as a Ruger 1022, Competition edition.  
3 Q Is that a pistol?  
4 A That's a rifle.  
5 Q A rifle. And what is the handgun that you're  
6 referencing?  
7 A It's also a Ruger. I can't remember the  
8 model.  
9 Q Okay. And in paragraph six, you say at least  
10 one rifle. Are there other rifles that you own that use  
11 the same magazine as a pistol you own?  
12 A Yes.  
13 Q Can you tell me what those are?  
14 A If I got my numbers right, Kel-Tec CMR-30, and  
15 Kel-Tec PMR-30.  
16 Q And which is which there?  
17 A The -- The latter is the pistol.  
18 Q So the Kel-Tec --  
19 A PMR-30 is the pistol and the CMR-30 is the  
20 rifle.  
21 Q And when you wrote at least one -- Well, let  
22 me pause for a second. Are there any others where you have  
23 a pistol and a rifle that share or use the same magazine?  
24 A Yes.  
25 Q What other ones?

Page 23

1 A I'm -- Beretta 92A and Beretta Cx4.  
2 Q You mentioned that earlier at the beginning;  
3 is that right?  
4 A Uh-huh (yes).  
5 Q Any others?  
6 A I don't think so.  
7 Q Okay. Are there rifles you own that don't use  
8 a magazine, the same magazine as any of the pistols you  
9 own?  
10 A I'm sorry. You have to read that back.  
11 (The requested portion of the  
12 record read by the reporter.)  
13 A Correct. No, I think the answer is no. I  
14 don't have anything else that -- systems that share.  
15 Q Got it. I'll clarify. So, for instance, you  
16 may own rifles that use magazines that only work in that  
17 rifle; is that right?  
18 A That's correct. And I would like to add if  
19 there is a system that I am unaware of that shares it in a  
20 pistol, I do not have it.  
21 Q Okay. And what are examples of rifles like  
22 that, that you own?  
23 A I don't have any other examples.  
24 Q Well, do you own, for instance, an AR-15  
25 rifle?

Page 24

1 A Yes.  
2 Q What type of AR-15 rifle?  
3 A No, I do not own an AR-15 rifle.  
4 Q What type of rifles do you own?  
5 A I have --  
6 Q Other than the ones we've already talked  
7 about?  
8 A I have a few lever action and I have a few  
9 bolt action.  
10 Q Do you have any semi-automatic rifles?  
11 A Yes.  
12 Q Do you have any semi-automatic rifles that  
13 have magazines that aren't interchangeable with the pistols  
14 you own?  
15 A As I stated earlier, yes.  
16 Q If PICA were struck down, what firearms would  
17 you purchase that you cannot currently purchase because  
18 PICA is in effect?  
19 A Well, I don't have enough money. I'd like to  
20 have something on the platform of an AR-10.  
21 Q Anything else that you would want to --  
22 A Right now, no. I have a purpose for it.  
23 Q Let me finish the question.  
24 A My bad. I'm sorry.  
25 Q No, it's okay. It's okay. Are there any

Page 25

1 other firearms beyond something on the AR-10 platform that  
2 you would purchase right now if PICA were not in effect?  
3 A At the moment, no.  
4 Q When did you develop the desire to purchase  
5 something on the AR-10 platform?  
6 A Do you understand what nuisance permits are  
7 for deer?  
8 Q Yes. I have some understanding.  
9 A Okay. I live on 80 acres and beside my 80 is  
10 another 80 that has not been hunted for at least  
11 three decades and the -- Are you familiar with farming?  
12 Q Yes.  
13 A Do you understand what rows are?  
14 Q Yes.  
15 A Okay. So if you take the first 24 rows, my  
16 yields are nothing. So I would like to have something like  
17 that to nuisance hunt with.  
18 Q So to take care of the deer population, for  
19 instance?  
20 A Well, that -- That's the main reason. I think  
21 it's a smooth, elegant platform.  
22 Q And in terms of caliber, what about the AR-10  
23 platform appeals to you?  
24 A I have a friend that builds them and he's got  
25 the accuracy dialed in. So I would like to copy what he's

Page 26

1 doing.  
2 Q And is the AR-10 an AR-type firearm?  
3 A I don't think so.  
4 Q Why not?  
5 A If you compare it to the original back in the  
6 '50s, I think it's been -- I don't think they share enough  
7 stuff to be in the same family.  
8 Q When you say the original back in the '50s,  
9 what are you referring to?  
10 A The ArmaLite 15.  
11 Q So when someone says AR-type, you think of --  
12 A I think that's so generic.  
13 Q Let me just finish again.  
14 A My bad. My bad. There was a pause in there.  
15 Q No, it's okay. I pause a lot. I talk slowly.  
16 When you say the original back in the '50s, are you  
17 referring to the AR-15 design by Eugene Stoner?  
18 A Yeah. The one that evolved into the M-16 that  
19 got all of our guys killed in 'Nam.  
20 Q So when I say AR-type, your first thought is  
21 AR-15?  
22 A Yeah. Back to the original platform, yes.  
23 Q Would you include AR-10 in AR-type?  
24 A No.  
25 Q That was a no?

Page 27

1 A Correct.  
2 Q Why not?  
3 A I don't think they share enough from the  
4 original. From the original --  
5 Q What do you mean by that?  
6 A I think they hastily rushed that thing  
7 together to answer the AK, is what I think, and it got a  
8 lot of guys killed in Vietnam.  
9 Q Is that one of the reasons why you don't want  
10 to have an AR-15?  
11 A Yes. My father was a Vietnam veteran and he  
12 forbid me from having one.  
13 Q And as you've said before, you don't currently  
14 have an AR-15 and you have no plans to obtain one?  
15 A Not unless one's given to me. I never turn  
16 down a free gun.  
17 Q But absent someone giving an AR-15 to you --  
18 A I don't plan on purchasing one.  
19 Q You mentioned in your declaration in paragraph  
20 three, which is marked as Exhibit 1, and this is your  
21 May 19th, 2023, declaration. "I'm a lifetime firearm owner  
22 and am familiar with most kinds of common firearms and  
23 magazines."  
24 When did you first get a firearm?  
25 A I think age 14.

Page 28

1 Q And have you owned firearms since then?  
2 A Oh, yes.  
3 Q When you say you're familiar with most kinds  
4 of common firearms and magazines in paragraph three of your  
5 May 19 declaration, how did you develop this familiarity?  
6 A When you get to go to the shooting range,  
7 everybody is excited to show off their stuff and let you  
8 shoot it. And if you put a little money in for ammunition,  
9 they let you shoot a little bit more.  
10 Q So from going to the shooting range, that's  
11 one way that you developed familiarity?  
12 A (Witness nods head affirmatively.)  
13 Q Are there other ways that you have become  
14 familiar with firearms?  
15 A YouTube.  
16 Q YouTube?  
17 A (Witness nods head affirmatively.)  
18 Q Anything else on the internet?  
19 A I can't think of any forums that I like.  
20 Q Are there other sources of knowledge where --  
21 that you have relied on to develop your familiarity with  
22 firearms?  
23 A I can't think of the names of books.  
24 Q But there may be some books that you've --  
25 A Yeah, there have been. Yeah. I looked

Page 29

1 into -- at Wabash Valley College, they had a firearms  
2 maintenance program, I think. I looked into that, but I  
3 couldn't get time to -- with the business and school, I  
4 couldn't make the two schedules line up.  
5 Q Got it. I'm going to mention some websites,  
6 and I want to hear from you whether or not you've ever  
7 looked at those websites.  
8 A All right.  
9 Q Have you ever visited Pew Pew Tactical?  
10 A No.  
11 Q Have you ever seen any of their videos on  
12 YouTube?  
13 A I don't think so.  
14 Q How about guns.com, have you ever visited  
15 guns.com?  
16 A No.  
17 Q How about AR Build Junkie?  
18 A No.  
19 Q When I say AR Build and AR Build Junie, what  
20 do you think the AR refers to?  
21 MR. MAAG: Calls for speculation. You can  
22 answer.  
23 A I don't know.  
24 Q (By Mr. Wells) How about American Rifleman, is  
25 that a source that you rely on?

Page 30

1 A Is that the magazine?  
2 Q So it's an NRA publication.  
3 A I get that, yes.  
4 Q So you receive the NRA Rifleman magazine?  
5 A Yes.  
6 Q How about AR-15.com, is that a website that  
7 you have been to?  
8 A No.  
9 Q The Truth About Guns, is that a website that  
10 you have been to?  
11 A Possibly.  
12 Q Do you ever look at gun manufacturers'  
13 websites?  
14 A Yes.  
15 Q Do you look at gun manufacturers' websites to  
16 learn about their products?  
17 A Yes.  
18 Q Do you rely on that information?  
19 A Yes. Because I believe that the manufacturer  
20 probably has a better idea of defaults and corrections than  
21 just about anybody else.  
22 Q Do you ever read product reviews on gun  
23 manufacturers' websites?  
24 A No.  
25 Q How about Wikipedia, do you ever read about

Page 31

1 guns on Wikipedia?  
2 A I hadn't thought about that.  
3 Q Have you ever heard of Firearm Wiki?  
4 A No.  
5 Q Have you ever heard of the Shooter's Bible?  
6 A Yeah.  
7 Q Let the record reflect I'm showing the witness  
8 a Shooter's Bible, 114th Edition. So you are familiar with  
9 Shooter's Bible?  
10 A Yes.  
11 Q Do you have any copies of Shooter's Bible?  
12 A No.  
13 Q How are you familiar with it?  
14 A A couple of the gun stores I used to visit  
15 that don't exist anymore had them on display on the coffee  
16 table.  
17 Q Did you ever look at them?  
18 A Yeah.  
19 Q Did you ever rely on information in them to  
20 learn about firearms?  
21 A Sort of. I never really used their  
22 information to -- to purchase or grow my wish list.  
23 Q Have you ever received any formal firearms  
24 training?  
25 A Yes.

Page 32

1 Q What training?  
2 A I received the required training for the  
3 concealed carry and a friend of mine is the training deputy  
4 at home, so he's -- I have worked with him.  
5 Q Any other trainings?  
6 A No.  
7 Q Do you consider yourself a firearms expert?  
8 A On what I am familiar with, what I have laid  
9 hands on.  
10 Q So you would consider yourself a firearms  
11 expert on the firearms that you've laid hands on?  
12 A Yeah.  
13 Q Have you ever published any articles, books or  
14 other writings about firearms?  
15 A No.  
16 Q Have you ever held a job that involved using  
17 or selling firearms products?  
18 A Yes.  
19 Q What job was that?  
20 A It would be my own.  
21 Q When you say my own, what do you mean?  
22 A My job. When I have raccoons get inside my  
23 vehicles and destroy the wiring harness, I've got to get  
24 rid of that problem and fix the hole and fix the damage.  
25 And then I've also had -- I've had some skunks. I've



Page 33

1 eliminated skunks with my pistol.  
2 Q And what is the nature of that specific  
3 business where you're using your firearms?  
4 A Farm.  
5 Q Were you given any training specific to your  
6 job as a farmer related to your use of firearms?  
7 A No.  
8 (Deposition Exhibit No. 2 marked for  
9 identification.)  
10 Q (By Mr. Wells) Okay. I want to hand you your  
11 second sworn statement, which I'm going to mark as  
12 Exhibit 2. And we'll be going back and forth with these.  
13 Oops, look at that. The staple didn't work. Just keep  
14 that on there so it doesn't fall apart. These we're going  
15 to go back and forth with, so you want to keep them handy.  
16 MR. MAAG: You got a sticker this time maybe?  
17 No?  
18 MR. WELLS: Nope. Sorry, they are right here  
19 if you want them, Tom.  
20 MR. MAAG: No, that's okay.  
21 Q (By Mr. Wells) So do you recognize this  
22 document?  
23 A See, there's an example of the tools I was  
24 talking about, L-wrenches. Sorry, not to answer the  
25 question, but my mind will scroll a lot, so ...

Page 34

1 Q Understood. Do you recognize this document?  
2 A No, I don't.  
3 Q Okay. Let me direct your attention to -- and  
4 For the record, this is what I've marked as Exhibit 2.  
5 It's titled Affidavit of Matthew Wilson, has a case number  
6 at the top of 23-cv-0029 SPM, Document No. 117-1. It says  
7 filed 6/27/23. I'm directing your attention to page seven  
8 of 43.  
9 A Yep, I see my signature.  
10 Q Is that your signature there --  
11 A (Witness nods head affirmatively.)  
12 Q -- at the bottom? Let the record reflect --  
13 A Yes.  
14 Q -- the witness is pointing to a signature.  
15 A Yes.  
16 Q That's Matthew Wilson, that's you; is that  
17 right?  
18 A Yeah.  
19 Q So did you review this document before you  
20 signed it?  
21 A Yes.  
22 Q And is this document a reflection of your  
23 personal testimony?  
24 A Yes.  
25 Q All right. I'm going to direct your attention

Page 35

1 to paragraph nine.  
2 A Yes.  
3 Q I'm going to direct your attention to the  
4 last -- or the sentence down there that starts "the issue".  
5 Do you see that?  
6 A Yes.  
7 Q So I'm going to read it to you. It says, "The  
8 issue is how is one to know that a given 15 through 11  
9 round magazine is a handgun magazine as opposed to a rifle  
10 magazine, or a 16 round magazine is for a firearm other  
11 than a rifle, shotgun or handgun, as defined. The  
12 ambiguity is on the magazine, not the firearm it may fit  
13 into."  
14 Is that your testimony?  
15 A That's what I brought up earlier, is a lot of  
16 these don't have markings for what they belong to and many  
17 of them are interchangeable and sometimes manufacturers  
18 will -- will inadvertently work in a different pistol.  
19 Q You said many of them are interchangeable.  
20 Many magazines are interchangeable between -- let me  
21 finish -- between handguns and rifles. Are there some  
22 magazines that are not interchangeable between handguns and  
23 rifles?  
24 A I believe so.  
25 Q And as I understand it from paragraph nine

Page 36

1 here in your June 27 declaration, your concern is that if I  
2 handed you a magazine by itself and you had no other  
3 information to go on, other than looking at the magazine,  
4 you could not say whether the magazine was for a handgun or  
5 a rifle; is that right?  
6 A Yeah. That could be the case.  
7 Q If I handed you a magazine and didn't give you  
8 any other information, what information could you figure  
9 out from just looking at the magazine?  
10 A I could probably only be able to tell whether  
11 or not the user took care of his equipment or not.  
12 Q Would you be able to tell the caliber?  
13 A Maybe.  
14 Q Do magazines sometimes list the caliber on  
15 there?  
16 A Sometimes they do, sometimes they don't.  
17 MR. MAAG: If you like, we have some actual  
18 magazines that you can ask him about.  
19 MR. WELLS: That's okay.  
20 MR. MAAG: I didn't think you would want to.  
21 Q (By Mr. Wells) Could you tell the capacity at  
22 a certain caliber by looking at a magazine?  
23 A Sometimes yes, sometimes no.  
24 Q Could you tell the manufacturer of a  
25 particular magazine?

Page 37

1 A Sometimes yes, sometimes no. Not everybody  
2 stamps or laser engravings.

3 Q Can you give me examples of magazines where  
4 you would be able to tell the caliber just by looking at  
5 the magazines?

6 A I think some of Smith & Wesson and some of  
7 Glock.

8 Q How about of your personal firearms, do your  
9 personal firearms have on the magazines the caliber?

10 A I don't think so.

11 Q Do they have the manufacturer?

12 A Some do, some don't.

13 Q But you know personally what magazines -- or  
14 what firearms those magazines are for; right?

15 A Right.

16 Q And you would agree with me that not all  
17 magazines can be used in all firearms; correct?

18 A Physically impossible.

19 Q For instance, you can't use a Beretta M-92  
20 9-millimeter magazine in a 5.56 NATO caliber AR-15;  
21 correct?

22 A You shouldn't be able to.

23 Q For two firearms to be able to use the same  
24 magazine, the firearms at least have to use the same  
25 caliber of ammunition?

Page 38

1 A Roughly.

2 Q Roughly. When you say roughly, what do you  
3 mean?

4 A If I remember right, .308 and 76 -- I can't  
5 remember. 762 by 51 or 762 by 54.

6 MR. MAAG: Just what you remember.

7 A Yeah. I think you can put the 762 or -- yes,  
8 if you had a -- I don't remember what the name of that was.  
9 I think you could put a .308 in a 762 by 54 and it would  
10 work, but you couldn't go the other way.

11 Q (By Mr. Wells) But it's got to be pretty  
12 close; right?

13 A It has -- If you're saying work, as in work as  
14 it was intended to, if you get much past those tolerances,  
15 the efficiency is gone.

16 Q When you say the efficiency is gone, what do  
17 you mean?

18 A Okay. Imagine a paper towel tube. If you put  
19 a bullet in it that size, all the gases are going to go  
20 past the bullet and then therefore you have nothing. But  
21 if you had something that was close to that in size, it  
22 would utilize the barrel as close as it could to project  
23 the bullet.

24 Q And let the record reflect, that the witness  
25 was holding his hand up in a circle and putting a pen to

Page 39

1 simulate the barrel. So you mentioned that the barrel and  
2 the bullet have to be kind of a close fit in order for the  
3 bullet to actually have enough velocity and work the way  
4 it's intended?

5 A Yes, I have seen -- and I'm comparing apples  
6 to oranges on this one. I have seen people put 50 BMG in a  
7 12-gauge. It will fit, but it doesn't have the same feet  
8 per minute as it would coming out of what it was  
9 intended -- the 50 BMG was intended to come out of.

10 Q For instance?

11 A For, like, Ma Deuce, for example.

12 Q Okay. So the example I gave you earlier of a  
13 Beretta M-92 9-millimeter, you could not put that  
14 9-millimeter round into a 5.56 NATO AR-15 and fire the  
15 AR-15; correct?

16 A If you did, it would explode.

17 Q So that would be bad; correct?

18 MR. MAAG: Depends on your point of view.

19 A If you like your eyes and your fingers, yeah,  
20 it's bad.

21 Q (By Mr. Wells) So you can't -- you can't --  
22 There's certain weapons, there's certain firearms, where if  
23 you load them with the wrong caliber of ammunition, it can  
24 cause the firearm to explode; correct?

25 A If you could even get the ammunition in there.

Page 40

1 Q It may not fit; is that right?

2 A It may not cycle.

3 Q When you say cycle, what do you mean?

4 A I wish I had an example. But if the bolt  
5 doesn't come all the way down, firing pin won't pull. So  
6 it won't strike the primer and won't go anywhere.

7 Q You mentioned earlier your Beretta M-92 that  
8 uses 9-millimeter.

9 A Yeah.

10 Q And your Beretta Cx4 rifle, that caliber is  
11 also a 9-millimeter?

12 A Right.

13 Q And that -- them both -- the Beretta Cx4 and  
14 the Beretta M-92 both using 9-millimeter ammunition is the  
15 reason why they can have interchangeable magazines; right?

16 A You have to ask the manufacturer why that  
17 works.

18 Q But if they didn't share the same caliber, you  
19 wouldn't be able to interchange the magazines; is that  
20 right?

21 A It's not likely.

22 Q Are you familiar with the Beretta ARX 100?

23 A I don't think I've held one.

24 Q Is that a no?

25 A Correct. No.



Page 41

1 (Deposition Exhibit No. 3 marked for  
2 identification.)  
3 Q (By Mr. Wells) I'm going to mark Exhibit 3  
4 here and hand it to you. No sticker. Sorry, Tom.  
5 MR. MAAG: I feel cheated, as much as I pay in  
6 taxes to the state.  
7 Q (By Mr. Wells) I'm directing your attention to  
8 what I have marked as Deposition Exhibit 3. I can  
9 represent to you that this is a printout from the Beretta  
10 website. You can see at the bottom it's got the URL of  
11 <https://www.beretta.com/en-us/arx-100>. Do you see that?  
12 A Yes, I do. Lower left-hand corner.  
13 Q Right. And I would ask you to flip to the  
14 second page, so page two of five, and next to caliber, what  
15 does it say there?  
16 A It says 556.  
17 Q And what does 556 refer to?  
18 A 556-millimeter.  
19 Q And that's a caliber of a firearm?  
20 A It's an equivalent of a caliber.  
21 Q When you say equivalent of a caliber, what do  
22 you mean?  
23 A In the American side of it, we call it  
24 caliber. In -- Everywhere else in the world that adopted  
25 the metric system, they run on millimeters.

Page 42

1 Q But 556 here refers to the caliber of  
2 ammunition that you would use this in the Beretta --  
3 A Yes.  
4 Q -- ARX 100? Just let me finish. That was a  
5 yes?  
6 A Correct.  
7 Q 9-millimeter ammunition won't work in the ARX  
8 100; correct?  
9 A No. If the picture is an accurate  
10 representation, I don't think you could even get that in  
11 the magazine.  
12 Q Okay. You can set that to the side. You can  
13 set that exhibit to the side, yeah. So is it fair to say  
14 that there are some calibers that are more commonly used in  
15 rifles than in handguns?  
16 A You're going to have to break that down  
17 farther.  
18 Q So, for instance, are you familiar with the  
19 6.5 Grendel ammunition?  
20 A No.  
21 Q Are you familiar with the 338 Lapua?  
22 A Lapua.  
23 Q Although, I think there is a debate online  
24 about how it's pronounced.  
25 A There is?

Page 43

1 Q Yes.  
2 A I conned a friend of mine into naming his  
3 puppy Lapua.  
4 Q I'll go with Lapua. All right.  
5 MR. MAAG: I think the Finns pronounce it  
6 Lapua, so ...  
7 Q (By Mr. Wells) Okay. Well, that's, you  
8 know --  
9 MR. MAAG: It's designed in Finland. I think  
10 they get to pick.  
11 Q (By Mr. Wells) They probably do. For your  
12 second witness, I have a story about pronunciation. 338  
13 Lapua, that tends to be a rifle caliber; right?  
14 A Yeah. That's a pretty awesome platform.  
15 Q Are you aware of any handguns that use the 338  
16 Lapua?  
17 A Nope.  
18 Q Some calibers are better suited for a rifle  
19 because of the amount of recoil; right?  
20 A I just think it depends on how tough you are.  
21 Q You do sometimes prefer a different caliber,  
22 though, because of the recoil?  
23 A No. I prefer a different caliber for a  
24 different job. So if I am using something inside of a  
25 building, I want a .22, or a bird shot, so I don't go

Page 44

1 through the building. If I'm reaching out and touching  
2 something, I want something like your 338 Lapua, because  
3 that is a nice, flat trajectory.  
4 Q So, for instance, that 338 Lapua, it has a  
5 much longer range than a .22 --  
6 A Oh, yes.  
7 Q Let me finish.  
8 A I'm sorry.  
9 Q A 338 Lapua has a much longer range than the  
10 .22 that you just mentioned; right?  
11 MR. MAAG: If you know.  
12 A I don't know because I don't have a 338 Lapua  
13 and I know on the boxes of the .22s it says deadly within  
14 one and a quarter mile.  
15 Q (By Mr. Wells) Do you agree that caliber  
16 affects range?  
17 A No.  
18 Q A special operations sniper is not going to  
19 use a handgun with 9-millimeter ammunition to take out a  
20 target a thousand yards away, though; right?  
21 MR. MAAG: If you know what special operations  
22 snipers use.  
23 A I don't know what they use, and I -- that's  
24 not to say that there's not something out there that's not  
25 on the market available to us that they have that we don't.

Page 45

1 Q (By Mr. Wells) Do you hunt?  
2 A Yeah.  
3 Q What's your range hunting? How far out?  
4 A Oh, I'm limited because the State of Illinois  
5 won't let me have anything real. I could do 75 yards with  
6 my bow and I can do -- if I don't have any wind, I can do  
7 300 with my shotgun, but I haven't yet purchased a rifle  
8 because the rifle season is new. If I could have 338  
9 Lapua, hunting would be fun.  
10 Q Do rifles generally have longer range than  
11 handguns?  
12 A If you're comparing same caliber to same  
13 caliber, yes.  
14 Q How about an AR-15 with 5.56 NATO compared to  
15 a Beretta M-92 in 9-millimeter, which has the longer range?  
16 A I'm not sure.  
17 Q In addition to caliber, what else has to be  
18 the same about two firearms in order for them to be able to  
19 use the same magazine?  
20 A Preferably if they have the same accept, the  
21 same cartridge.  
22 Q Anything else?  
23 A Have to have the same well. That's all I can  
24 think of.  
25 Q Is it fair to say, for instance, a Beretta

Page 46

1 M-92 may not have the same well as a Glock that uses  
2 9-millimeter?  
3 A Yes.  
4 Q Do you agree that there is a category of  
5 firearms called handguns?  
6 A Yes.  
7 MR. MAAG: Are you asking -- Go ahead.  
8 Q (By Mr. Wells) What is a handgun?  
9 MR. MAAG: Are you asking as defined in the  
10 statute or generally speaking?  
11 MR. WELLS: Based on his knowledge.  
12 MR. MAAG: So generally speaking?  
13 MR. WELLS: Yes.  
14 A Can you repeat his last question?  
15 (The requested portion of the  
16 record read by the reporter.)  
17 A I hadn't answered that yet? Yes, I agree.  
18 Q (By Mr. Wells) Do you agree there is a  
19 category of firearms called shotguns?  
20 A Yes.  
21 Q Do you agree there's a category of firearms  
22 called rifles?  
23 A Yes.  
24 Q Do you agree that rifles are, generally  
25 speaking, shoulder-fired firearms?

Page 47

1 A You said generally? Yes.  
2 Q Do you agree that shotguns are generally  
3 shoulder-fired firearms?  
4 A Yes.  
5 Q When you buy a new firearm from a gun store,  
6 the firearm comes with a magazine for that firearm?  
7 A Yes.  
8 Q And the manufacturer that made the firearm  
9 you're purchasing is also the manufacturer of the magazine?  
10 A Most of the time.  
11 Q And the manufacturer that made -- the  
12 manufacturer that made the firearm and made the magazine,  
13 they made the magazine to fit that specific firearm; right?  
14 A They'd have to.  
15 Q When you buy a new firearm with a magazine,  
16 you know how many rounds of a specific caliber of  
17 ammunition will fit in the magazine?  
18 A If it's so advertised, yes.  
19 Q And manufacturers do advertise the number of  
20 rounds that will fit in a particular magazine for a  
21 particular firearm; right?  
22 A Yes.  
23 Q Manufacturers include capacity as one of the  
24 specifications for a firearm in their advertising; correct?  
25 A I think so.

Page 48

1 Q And capacity refers to how many rounds will  
2 fit in the magazine or the magazine plus the firing  
3 chamber; is that right?  
4 A I agree.  
5 Q So sometimes they'll list 15 rounds, sometimes  
6 the manufacturer will list 15 plus one; is that right?  
7 A That's what I've seen.  
8 Q And the 15 plus one situation is when there's  
9 a 15-round magazine and you can also have a round in the  
10 chamber; is that fair?  
11 A Yes.  
12 (Deposition Exhibit No. 4 marked for  
13 identification.)  
14 Q (By Mr. Wells) All right. We are on No. 4.  
15 I'm handing the witness what I have marked as Deposition  
16 Exhibit 4. This one has a photocopied sticker for you,  
17 Tom.  
18 MR. MAAG: Photocopied sticker.  
19 Q (By Mr. Wells) All right. So I have just  
20 handed the witness what I have marked as Deposition  
21 Exhibit 4, which is a -- I can represent to you is a  
22 printout from the Walther -- Do you say Walther or Walther?  
23 A Walther.  
24 Q Walther. Walther.  
25 MR. MAAG: Never watched a James Bond movie,

Page 49

1 did you?  
2 A That's exactly my reference.  
3 Q (By Mr. Wells) I thought it was German. So  
4 you do the hard "th" like Thomas.  
5 MR. MAAG: No, it's Walther.  
6 Q (By Mr. Wells) All right. Walther. From  
7 Walther's website, I've got the URL up there at the top,  
8 waltherarms.com/pdp. Are you familiar with the Walther PDP  
9 handgun?  
10 A No. Come to think of it, I don't think I have  
11 held anything Walther.  
12 Q Do you remember reviewing a deposition -- or,  
13 I'm sorry, a declaration from our expert in this case,  
14 named James Yurgealitis?  
15 A I have read so much in the last 10 days, I  
16 can't remember everything.  
17 Q So I'm going to direct your attention back to  
18 Deposition Exhibit 2. Right there. Paragraphs two, three  
19 and four. You say, "I have been provided and have read the  
20 supplemental affidavit of James E. Yurgealitis."  
21 Do you see that?  
22 A Yeah, but --  
23 MR. MAAG: That's just saying he read the  
24 affidavit.  
25 A I've read it, but recalling everything, I

Page 50

1 can't recall everything.  
2 Q (By Mr. Wells) Okay. And in paragraph five,  
3 do you see --  
4 A Yes.  
5 Q -- at the bottom, 5G, Walther PDP? Do you see  
6 that?  
7 A Uh-huh (yes).  
8 Q So you reviewed Mr. Yurgealitis' declaration  
9 and you saw the reference to the Walther PDP; is that  
10 right?  
11 A Tom walked me through that.  
12 Q And the Walther PDP is one of the firearms  
13 that you described as follows in paragraph seven. Go on  
14 here now.  
15 "While I'm personally unaware of any rifles  
16 that use the other listed magazines, there is no reason  
17 that such a rifle could not be constructed, nor is there  
18 any way to know whether or not any such rifles have been so  
19 constructed and sold."  
20 So the Walther PDP is an example of a handgun  
21 that Mr. Yurgealitis mentioned where you're not aware of  
22 any rifle that uses the same magazine; is that fair to say?  
23 A That's fair to say.  
24 Q So I'm going to direct your attention to the  
25 second page of Exhibit 4. So this is the Walther PDP

Page 51

1 website screenshots. Right here.  
2 MR. MAAG: Which page are we on?  
3 MR. WELLS: Page two. Sorry. And they are  
4 kind of topsy-turvy a little bit.  
5 MR. MAAG: I'm looking for a page number.  
6 A You don't have page numbers.  
7 MR. MAAG: You're fine.  
8 A If you fold the top one.  
9 Q (By Mr. Wells) Yeah. I think -- Actually,  
10 there you go. So do you see where it says PDP compact?  
11 A Yes.  
12 Q Okay. Do you see where it says magazine  
13 capacity?  
14 A Yes.  
15 Q How many rounds does it list?  
16 A It says 15.  
17 Q I'm going to move on to the PDP full-size  
18 4-inch. Do you see where it says magazine capacity?  
19 A Yes.  
20 Q How many rounds does it list?  
21 A It says 18.  
22 Q So is it fair to say for the PDP compact you  
23 can get a magazine that has 15 rounds?  
24 MR. MAAG: Are you asking if that's what it  
25 says or whether that's true?

Page 52

1 Q (By Mr. Wells) Is it your understanding based  
2 on this, going to the Walther website, that you could  
3 purchase a PDP compact with a magazine of 15 rounds?  
4 A Yes, it looks like I could purchase it that  
5 way.  
6 Q And you could also purchase, at least  
7 according to this website, the PDP full-size with a  
8 magazine capacity of 18 rounds. Do you see that?  
9 A I believe today I can't purchase that anymore.  
10 Q Okay. So you understand that between these  
11 two firearms, you could purchase the PDP compact with the  
12 15-round magazine, but because of PICA you couldn't  
13 purchase the PDP full-size because of the 18-round  
14 magazine; is that right?  
15 A I may be able to purchase the pistol, but I  
16 would not be able to have a magazine.  
17 Q So you could purchase the pistol, but not the  
18 magazine; is that correct?  
19 A That's my understanding.  
20 Q And that's because under PICA, the magazine  
21 limit for pistols is 15 rounds; is that right?  
22 A Yes.  
23 Q Do you see at the bottom of the page here,  
24 where it says 10-round item?  
25 A Yes.

Page 53

1 Q Do you have an understanding as to what that  
2 might mean?  
3 A No. I'm assuming it's a --  
4 MR. MAAG: That's on the third page?  
5 MR. WELLS: The same page.  
6 A No, no. It's at the bottom -- the bottom of  
7 the compact.  
8 MR. MAAG: Got it.  
9 Q (By Mr. Wells) What do you think that means,  
10 the 10-round item?  
11 A I'm assuming it's a compliance issue.  
12 Q When you say compliance issue, what do you  
13 mean?  
14 A For the states that limited everything down to  
15 10, they offered it with that magazine so it could be sold  
16 in a state like California.  
17 Q So if you lived in California, you would know  
18 that you could only purchase the 10-round magazine for that  
19 handgun; is that right?  
20 MR. MAAG: Objection. He's not an expert on  
21 California law.  
22 Q (By Mr. Wells) Understood. But if you lived  
23 in a state that had the 10-round magazine limit, you would  
24 only be able to purchase the 10-round magazine for the  
25 Walther PDP compact; is that right?

Page 54

1 A Right.  
2 Q And Walther does offer 10-round magazines;  
3 right?  
4 A That's what that looks like.  
5 Q So I'm going to direct your attention to the  
6 last page. That one's easier. The last page of what I  
7 have marked as Deposition Exhibit 4. This is another  
8 printout from the Walther website. Take a second to look  
9 at it.  
10 Does this indicate to you that Walther sells a  
11 10-round magazine for --  
12 A That's what it looks like.  
13 Q -- the PDP pistol?  
14 A That's what it looks like.  
15 Q Okay. You can put that one away.  
16 A Will we be referencing it again?  
17 Q Probably not.  
18 A Okay.  
19 Q Let's see here.  
20 MS. HELFRICH: It's an hour.  
21 MR. WELLS: At an hour. Do you want a break?  
22 THE WITNESS: I'm good.  
23 MR. WELLS: Give me one second. Let me take a  
24 sip of water. The key is for me not to knock that over.  
25 MR. MAAG: Like this?

Page 55

1 MR. WELLS: Might cool you down, though. It's  
2 hot in here.  
3 MR. MAAG: I'm comfortable.  
4 MR. WELLS: I run hot, always have. All  
5 right. I will put a sticker on this one.  
6 MR. MAAG: The book, Stimpy, the book.  
7 MR. WELLS: Is that a running Stimpy  
8 reference?  
9 MR. MAAG: It is.  
10 MR. WELLS: All right. I'm going to put a  
11 sticker on this one. What number are we up to?  
12 THE REPORTER: Five.  
13 MR. WELLS: I'm giving you a sticker, Tom.  
14 MR. MAAG: Thank you.  
15 (Deposition Exhibit No. 5 marked for  
16 identification.)  
17 Q (By Mr. Wells) I'm handing you what has been  
18 marked as Deposition Exhibit 5, which is an excerpt, so  
19 it's not the full thing, of Shooter's Bible, 114th Edition.  
20 I have a full copy here, just so you know, but these are  
21 copies of pages from the Shooter's Bible.  
22 A CliffsNotes.  
23 Q Yeah, or selections from it. So I'm going to  
24 direct your attention to page 153. So you'll see it says  
25 at the bottom right there.

Page 56

1 MR. MAAG: Skipped a few here.  
2 Q (By Mr. Wells) All right. So directing your  
3 attention to page 153 of what I have marked as Deposition  
4 Exhibit 5, which is the Shooter's Bible, 114th Edition.  
5 A Same page, right?  
6 Q Correct. Do you see where it says  
7 Heckler & Koch?  
8 A I see it at the bottom.  
9 Q Yep. I'm going to direct your attention to  
10 the Heckler & Koch MR762A1. Do you see that particular  
11 firearm?  
12 MR. MAAG: Bottom right-hand corner.  
13 Q (By Mr. Wells) That one.  
14 A The bottom right?  
15 Q No, middle.  
16 A Middle. MR762A1.  
17 Q What do you think the 762 refers to there?  
18 A Diameter of the round.  
19 Q Which we might also call the caliber?  
20 A Could be called a caliber, yes.  
21 Q And the Heckler & Koch MR762A1 is a rifle;  
22 correct?  
23 A It looks like a rifle, yes.  
24 Q And a rifle is a long gun; right?  
25 MR. MAAG: Object to what's meant by long.

Page 57

1 A Please clarify.  
2 MR. MAAG: They can have a short barrel, a  
3 long barrel, a --  
4 A Because there are such things as  
5 short-barreled rifles.  
6 Q (By Mr. Wells) Right. Do you own any  
7 short-barreled rifles?  
8 A I wish I did.  
9 Q But under federal law, you would have to  
10 follow additional hoops to get a short-barreled rifle;  
11 right?  
12 A Right. And I'm too cheap to pay for that.  
13 Q And if -- In order to avoid having to go  
14 through those hoops to comply with federal law, there is a  
15 regulation on barrel length for rifles; is that right?  
16 A There are regulations on barrel lengths.  
17 Q So for rifles that are not short-barreled  
18 rifles, would you call those long guns?  
19 A I suppose.  
20 Q Long guns tend to be shoulder-fired; is that  
21 right?  
22 A You could fire anything from the hip.  
23 Q Right. But generally speaking, rifles have --  
24 A A buttstock.  
25 Q -- a buttstock that enables you to fire from

Page 58

1 the shoulder; is that right?  
2 A I would say they are designed that way.  
3 Q When you go hunting, do you shoot from the  
4 hip?  
5 A If it's close, yes.  
6 Q But ordinarily if it's at long-range and you  
7 want to be precise and accurate you would fire from the  
8 shoulder; right?  
9 A That's right. Yeah, if you want to say that.  
10 Q So I want to -- imagine if you owned a  
11 grandfathered version of the Heckler & Koch MR762A1 and you  
12 needed to replace the magazine. Do you see where it says  
13 magazine there?  
14 A Yes.  
15 Q And it lists 10 rounds and 20 rounds?  
16 A Yes.  
17 Q Under PICA, which magazine could you purchase  
18 legally?  
19 A Only the 10.  
20 Q And these three rifles that you see down here,  
21 the three Heckler & Koch rifles, they use 5.56 NATO, 7.62  
22 NATO and seven -- two of them use 7.62 NATO. Do you see  
23 that?  
24 A Yes.  
25 Q 5.56 NATO and 7.62 NATO are more common as a

Page 59

1 rifle caliber; correct?  
2 A Would you read that back, please?  
3 (The requested portion of the  
4 record read by the reporter.)  
5 MR. MAAG: Objection. Vague. More common  
6 than what?  
7 Q (By Mr. Wells) Than as a pistol caliber.  
8 A I'm not sure.  
9 Q All right. We are still in Shooter's Bible.  
10 We're going to go to page 363, Heckler & Koch.  
11 A I know. Mine is not -- 363 you said? I'm a  
12 page short.  
13 Q There you go.  
14 All right. So we are at page 363 of  
15 Deposition Exhibit 5, Shooter's Bible, 114th Edition. I'm  
16 directing your attention to upper left-hand corner,  
17 heckler & Koch SP5. Do you see that?  
18 A Yes.  
19 Q Do you see where it says capacity there?  
20 A Yes.  
21 Q For the Heckler & Koch SP5, what is the  
22 capacities that Heckler & Koch offers for the magazines?  
23 A 10, 15 and 30-round.  
24 Q Under PICA, which of those magazines could you  
25 purchase legally?

Page 60

1 A I'm not sure I could purchase any of them.  
2 Q If you owned a grandfathered Heckler & Koch  
3 SP5, so you owned it before January the 10th, and you  
4 needed to replace the magazine --  
5 A Like I said, I'm not sure I could buy any of  
6 them.  
7 Q Why not?  
8 A My understanding of PICA is we can no longer  
9 have a pistol that does not contain the magazine inside the  
10 grip. So I'm not sure if I would legally be allowed to  
11 replace it or not.  
12 Q Do you understand that PICA allows weapons  
13 that were lawfully owned prior to January 10, 2023, for  
14 people to keep owning them if they submit certain  
15 information to the Illinois State Police?  
16 A That's my understanding, but that doesn't --  
17 to my understanding, it doesn't include servicing them. So  
18 if these get destroyed or are wore out, I'm not sure that  
19 we can have them anymore.  
20 Q When you say these, what are you referring to?  
21 A The magazines. Not the pistol. The magazine.  
22 Q So I want you to assume, just for purposes of  
23 this question, that it's legal under PICA to have a  
24 Heckler & Koch SP5 as long as you comply with the  
25 endorsement affidavit requirement, and you're looking to



Page 61

1 replace the magazine. Which magazine can you purchase for  
2 this handgun under PICA?  
3 A The 10 and 15.  
4 Q But not the 30?  
5 A My understanding of PICA is we can't no  
6 longer -- it exceeds the 15-round limit.  
7 Q Do you see on the right-hand side of this  
8 page, where it says handguns?  
9 A Uh-huh (yes).  
10 Q Is that a yes?  
11 A Yes, sir, I do.  
12 Q Sorry. She sometimes can't --  
13 A I understand. I understand. I'm not used to  
14 this format.  
15 Q No, it's unnatural. All right. So let's see.  
16 I'm going to direct your attention back to your June 27,  
17 '23, affidavit.  
18 A That's No. 2?  
19 Q I hope so.  
20 MS. HELFRICH: Yes.  
21 A Are we through with this?  
22 Q (By Mr. Wells) Yeah. You can put that away.  
23 We might come back to it, but --  
24 A I'll leave it on that page.  
25 Q Okay. So I'm going to direct your attention

Page 62

1 to paragraph 6A. 6A, you say, "The CZ, Model 75 and the  
2 Shadow are variants of the same pistol, use the same  
3 magazine, and the magazines are also used in the Kel-Tec  
4 SUB2000 Gen2 rifles."  
5 Do you see that?  
6 A Yes.  
7 Q And then it says, "See Exhibits A, B, C and  
8 D."  
9 Do you see that?  
10 A Yes.  
11 Q Okay. I'm going to direct your attention to  
12 pages eight through nine, and you're looking at the top  
13 here, the blue.  
14 A All right.  
15 Q Eight through nine.  
16 A Okay.  
17 Q You can start on eight. And this is actually  
18 a page that you pointed to earlier in the deposition; is  
19 that right?  
20 A Yes. That's correct.  
21 Q Right. And it's -- What is shown here on page  
22 eight? Sorry, is it --  
23 A No, it was -- I didn't want to crimp it.  
24 MR. MAAG: Don't worry about destroying it.  
25 He can print more.

Page 63

1 A All right.  
2 Q (By Mr. Wells) Could you read that back  
3 please?  
4 (The requested portion of the  
5 record read by the reporter.)  
6 A An attachment.  
7 Q (By Mr. Wells) What do you mean by an  
8 attachment?  
9 A It is physically bolted on to the rifle -- or  
10 screws, machine screws. I'm sorry.  
11 Q And what is it called?  
12 A The kit, it's labeled as a Kel-Tec mag catch  
13 kit.  
14 Q What is a mag catch kit?  
15 A I don't remember.  
16 Q Okay. Is this an exhibit that you identified?  
17 A Yes.  
18 Q You said it was an attachment, the mag catch  
19 kit was an attachment or at least what's depicted on page  
20 eight was an attachment; is that right?  
21 A It's page eight. Yeah.  
22 Q And you said it's something that's bolted on  
23 to a firearm; is that right?  
24 A It has to be.  
25 Q Why does it have to be?

Page 64

1 A It's in the description.  
2 Q And what happened -- Why would you bolt it on  
3 to a firearm? What would be the purpose of doing that?  
4 A I'm not sure. I've slept since then.  
5 Q Is it fair to say that you would --  
6 A I remember.  
7 Q Go ahead.  
8 A Putting the magazine near the well holds it in  
9 place.  
10 Q And why would you purchase a Kel-Tec mag catch  
11 kit?  
12 A I'm not sure.  
13 Q Is it fair to say that you might purchase a  
14 Kel-Tec mag catch kit because you need that attachment to  
15 actually make the CZ 75 magazine work in the Kel-Tec  
16 SUB2000 Gen2 rifle; is that fair?  
17 A To assume that, yes.  
18 Q So that's -- Actually there's a kit that you  
19 have to buy for \$12.09 to make the Kel-Tec SUB2000 Gen2  
20 rifle take a magazine from the CZ 75 handgun; is that  
21 right?  
22 A I think so.  
23 Q So you have to physically modify the Kel-Tec  
24 SUB2000 Gen2 rifle with the Kel-Tec mag catch kit to make  
25 the CZ 75 magazine work in the Kel-Tec; is that right?

Page 65

1 A Right.  
2 Q I'm going to direct your attention to -- back  
3 to your declaration, so that's, I think, Exhibit 2. Still  
4 on Exhibit 2. Paragraph 6A.  
5 A The one we just referenced?  
6 Q Yes. The next sentence, "These are also  
7 similar to the Tanfoglio TZ-75, formerly imported by FIE or  
8 Florida in 1980s, and the AR-24 pistol, formerly imported  
9 by ArmaLite, which itself is a CZ 75 clone."  
10 Do you see that?  
11 A Yes.  
12 Q What kind of gun is a Tanfoglio TZ-75?  
13 A I believe it's a rifle.  
14 Q You say you believe. Are you sure?  
15 A No.  
16 Q It says here that the TZ-75 was formerly  
17 imported by FIE or Florida, I think that means of Florida,  
18 in the 1980s. Do you know if the Tanfoglio -- You say  
19 formerly imported. So it's no longer imported; is that  
20 right?  
21 A Formerly means no longer, yes.  
22 Q And those are your words, formerly imported?  
23 A Yes.  
24 Q Are you aware that the Tanfoglio TZ-75 was  
25 imported at some point in the 1980s?

Page 66

1 A I believe it was.  
2 Q Is that based on your personal knowledge or  
3 did you learn it somewhere?  
4 MR. MAAG: We can show you one if you want.  
5 MR. WELLS: I'm asking the witness.  
6 MR. MAAG: Okay.  
7 A I think it's one of the discussions we had at  
8 the gun shop.  
9 Q (By Mr. Wells) Okay. Do you know what the  
10 status of FIE, the business, is?  
11 A No.  
12 Q Are you aware that they declared bankruptcy in  
13 1990?  
14 A No.  
15 Q You also mention the AR-24 pistol in paragraph  
16 6A of your June 27th sworn statement. Again, you said  
17 formerly imported by ArmaLite. The AR-24 is no longer  
18 being imported; correct?  
19 A Not by FIE.  
20 Q How about by ArmaLite?  
21 A I don't think so.  
22 Q Do you own an AR-24?  
23 A No.  
24 Q Do you have any intent to purchase an AR-24?  
25 A Not currently.

Page 67

1 Q I'm directing your attention to paragraph 6B  
2 in Exhibit 2. So this is your declaration still.  
3 "As far as the Smith & Wesson 5900 series, the  
4 pistol is discontinued but uses the same magazine as the  
5 also discontinue," I think it means discontinued, "Marlin  
6 Camp rifle in 9-millimeter."  
7 Do you see that?  
8 A Yes.  
9 Q It says, "See Exhibit E."  
10 A Yes.  
11 Q "Marlin Camp rifles used to be sold as,"  
12 meaning at, "most Wal-Marts."  
13 Do you see that?  
14 A Yeah. Yeah, that was a neat setup.  
15 Q But the Marlin Camp rifle has been  
16 discontinued since 1999; correct?  
17 A Uh-huh (yes).  
18 Q Is that a yes?  
19 A Yes, sir.  
20 Q Do you own a Marlin Camp rifle?  
21 A No.  
22 Q Have you ever owned a Marlin Camp rifle?  
23 A No.  
24 Q And when you said that Marlin Camp rifles used  
25 to be sold at most Wal-Marts, how do you know that?

Page 68

1 A Dad told me about it.  
2 Q When?  
3 A Oh, wow. Probably '97.  
4 Q Are you aware that Marlin is now a subsidiary  
5 of Ruger?  
6 A Unfortunately, yes.  
7 Q Why do you say unfortunately?  
8 A I don't think quality control is going to be  
9 what it was.  
10 Q I may have already asked you this, so I  
11 apologize if I have, but do you have any intent to purchase  
12 a Marlin Camp rifle?  
13 MR. MAAG: Asked and answered.  
14 MR. WELLS: I'm sorry. I'll withdraw it. I  
15 couldn't remember. Thank you.  
16 MS. SGRO: Hey, Chris, we kind of lost his  
17 sound again. It helped that he was kind of like leaning  
18 forward with his back in the chair.  
19 MR. WELLS: I'm sorry. The witness is doing  
20 the best he can. We will try to --  
21 MS. SGRO: Thank you.  
22 Q (By Mr. Wells) Yeah. All right. I'm going to  
23 direct your attention back to 6B. And this is again in  
24 your declaration, Exhibit 2. You mentioned the  
25 Smith & Wesson 5900 series and you note that the pistol is



Page 69

1 discontinued?  
2 A Discontinued.  
3 Q Let me finish.  
4 A I'm sorry. My bad.  
5 Q The Smith & Wesson 5900 series, you say that  
6 the pistol is discontinued and that -- that's correct;  
7 right?  
8 A Correct.  
9 Q Do you know when the S&W 5900 series was  
10 discontinued?  
11 A No.  
12 Q So at least according to Wikipedia, it says  
13 1999. Does that sound about right to you?  
14 A I'm not sure.  
15 Q In paragraph 6B you're talking about a pistol  
16 that's been discontinued since the 1990s that uses a  
17 magazine that can also be used in a rifle that's been  
18 discontinued since the 1990s; is that fair to say?  
19 A Yes.  
20 MR. MAAG: Well, he was referring to  
21 Mr. Yurgealitis' affidavit that said that the 5900 --  
22 MR. WELLS: Do you have an objection?  
23 MR. MAAG: Yes. I mean, you're taking it out  
24 of context and he's referring to the -- rebutting  
25 Mr. Yurgealitis' affidavit where he says the 5900, there

Page 70

1 was no rifle that uses that magazine.  
2 Q (By Mr. Wells) Okay. I understand. But the  
3 Marlin Camp rifle has been discontinued since 1999, and  
4 that's one of the examples that you have picked; is that  
5 right?  
6 A Right. What we've cited.  
7 Q All right. I'm directing your attention to  
8 paragraph 9C, where you say, as to Ruger P85 -- I'm sorry,  
9 6C. Did I mess you up there?  
10 "As to the Ruger P85 and P89 they are variants  
11 of the same basic pistol, the P89 being a product-improved  
12 variant of the P85. Both pistols use the same magazine as  
13 the Ruger PC9 rifle."  
14 Do you see that?  
15 A I do.  
16 Q Is that your testimony?  
17 A Yes.  
18 Q You use the word variant. What do you mean by  
19 variant in this paragraph?  
20 A I kind of think of it like evolution. It's  
21 growth.  
22 Q So you have an understanding of what the word  
23 variant means?  
24 A That's my interpretation of variant.  
25 Q And in fact you used the word variant in your

Page 71

1 declaration; is that right?  
2 A I see it right there.  
3 Q And you say evolution, so the P85 was one type  
4 of handgun and it evolved into the P89; is that right?  
5 A Sort of, yes.  
6 Q And you understand that even the -- one of the  
7 firearms is called a P85 and another is called a P89, the  
8 fact that they are different numbers in the name, you  
9 understand that one can still be a variant of the other?  
10 A If that's what the manufacturer intended.  
11 Q Is that a yes?  
12 A Yes.  
13 Q And the reason they can be called  
14 variant is -- variants, the P85 and P89, is because they  
15 share common features; is that right?  
16 A They may also share common parts, being as how  
17 they came from the same manufacturer.  
18 Q Anything else that makes them common enough to  
19 call them a variant?  
20 A I can't think of any.  
21 Q The Ruger PC9 -- Oh, go ahead.  
22 A They may have used some of the same tooling in  
23 production. That's what came to mind.  
24 Q And it's the same manufacturer?  
25 A Yes.

Page 72

1 Q And it's the same caliber?  
2 A I think so.  
3 Q The Ruger PC9, it's a pistol caliber carbine;  
4 right?  
5 A I believe so.  
6 Q What is a pistol caliber carbine?  
7 A It would be -- It would be a rifle. I can't  
8 remember where the barrel length stops at to where it would  
9 be -- the carbine length of -- is shorter than a rifle  
10 length, but as you said or asked me earlier, it would still  
11 be considered a long gun, so the length would be a little  
12 more compact than the rifle. Overall length would be a  
13 little more compact.  
14 Q What does the pistol caliber mean?  
15 A My guess is a reference to the Luger  
16 9-millimeter.  
17 Q So when it says pistol caliber carbine, it's a  
18 carbine-style rifle?  
19 A Yes.  
20 Q With likely a 9-millimeter Luger caliber; is  
21 that right?  
22 A Yes.  
23 Q And 9-millimeter is a common caliber for  
24 handguns; right?  
25 A Yes.

Page 73

1 Q It's not as common as a caliber for rifles;  
2 right?  
3 A I have not seen as many available to choose  
4 from in rifles as pistols.  
5 Q Okay. I'm going to direct you to page 33 at  
6 the top, looking at the blue number. This is page 33 of  
7 Exhibit 2, which is your declaration of June 27th. And  
8 what's labeled in your declaration as Exhibit H.  
9 A Okay. I'm with you.  
10 Q I'm directing your attention to the one, two,  
11 three, fourth paragraph. Do you see where it says, "The  
12 past decade has seen a resurgence in the semi-automatic  
13 form of what is known as pistol caliber carbines (PCCs)."  
14 Do you see that?  
15 A I do. First sentence.  
16 Q And that's what we were just talking about,  
17 pistol caliber carbines; is that right?  
18 A Correct.  
19 Q Now, I'm going to direct your attention to  
20 paragraph 40 -- or, I'm sorry, page 40 up here.  
21 MR. MAAG: 4-0?  
22 Q (By Mr. Wells) 4-0. It's the conclusion  
23 section. I'm directing you to the second sentence that  
24 starts pistol caliber.  
25 A I'm with you.

Page 74

1 Q Pistol caliber --  
2 MS. HELFRICH: The videographer would like a  
3 break soon.  
4 MR. WELLS: Yeah. After this one. Give me  
5 one second.  
6 MR. MAAG: No break for you.  
7 Q (By Mr. Wells) Do you see where it says,  
8 "Pistol caliber long guns are an affordable compact" --  
9 A I do not.  
10 Q I'm sorry. At the bottom there. The second  
11 sentence.  
12 A Okay. Mid-sentence. Okay. I'm with you.  
13 Q You got it? So Exhibit 2, page 40, bottom of  
14 the page under conclusion, second sentence. It says,  
15 "Pistol caliber long guns are an affordable, compact,  
16 lightweight and low-recoiling option when compared with  
17 carbines or rifles chambered for rifle cartridges."  
18 Do you see that?  
19 A I do.  
20 Q Do you agree that not all rifles are pistol  
21 caliber carbines?  
22 A I agree.  
23 Q In fact, most rifles are not pistol caliber  
24 carbines; is that right?  
25 A I agree.

Page 75

1 Q Then are you aware that the Ruger PC9  
2 production was discontinued in 2006? Are you aware of that  
3 fact?  
4 A No.  
5 Q Do you own a Ruger PC9?  
6 A No.  
7 Q Do you have any intent to purchase a Ruger  
8 PC9?  
9 A I might.  
10 Q Do you have any intent right now?  
11 MR. MAAG: Today in this room?  
12 Q (By Mr. Wells) Today in this room.  
13 A No, I don't.  
14 Q Before PICA was enacted, were you planning to  
15 acquire a Ruger PC9?  
16 A That was not on my wish list.  
17 MR. WELLS: We can take a break.  
18 THE VIDEOGRAPHER: This is the videographer.  
19 We are going off the record. Time now is 11:10.  
20 (Whereupon, a short break was taken.)  
21 THE VIDEOGRAPHER: This is the videographer.  
22 We are back on the record. Time now is 11:18.  
23 Q (By Mr. Wells) So, Mr. Wilson, when we last  
24 left off, we were talking about one of the exhibits to your  
25 declaration from the American Rifleman. I'm going to

Page 76

1 direct you back to paragraph six of your declaration, so  
2 back to Exhibit 2.  
3 Still in Exhibit 2, back to paragraph 6C. It says,  
4 "As to the Ruger P85 and P89, they are variants of the same  
5 basic pistol, the P89 being a product-improved variant of  
6 the P85. Both pistols use the same magazine as the Ruger  
7 PC9 rifle."  
8 Do you see that?  
9 A Yes.  
10 Q What is your source of information for what we  
11 see in paragraph 6C?  
12 A YouTube.  
13 Q YouTube. Would it surprise you to know that  
14 the -- that Ruger itself, customer service department, says  
15 that the P85 does not actually use the same magazine as the  
16 Ruger PC9 rifle?  
17 A Yes.  
18 Q If the customer service department advised you  
19 not to use that particular magazine from a Ruger P85 in a  
20 PC9, would you follow that instruction?  
21 A I would definitely heed it. But it's like  
22 everything else, sometimes you accidentally put the wrong  
23 parts in the wrong place and then, wow, they fit and then  
24 you keep running with it.  
25 Q But would you agree that a manufacturer is

Page 77

1 more likely to know what works best in their firearms?  
2 A I would say they are more likely to put  
3 statements out to limit their liability.  
4 Q Because, for instance, if you used a magazine  
5 that you shouldn't use in a firearm, it could explode;  
6 right?  
7 A It could explode and then land back on them  
8 because they are the manufacturer.  
9 Q Are you aware that Ruger's customer service  
10 department advises that only certain P89 pistols in a  
11 specific serial number range use magazines that are  
12 interchangeable with some PC9 rifles manufactured in 2003  
13 or earlier?  
14 A I'm sorry. Would you read that back?  
15 (The requested portion of the  
16 record read by the reporter.)  
17 A No.  
18 Q So you didn't speak to anyone at Ruger to  
19 validate your statement about P85s and P89s using  
20 interchangeable magazines with the Ruger PC9?  
21 A No, I have not consulted Ruger.  
22 Q What was the basis of your statement there,  
23 about the P85 and P89 using the same magazine as the Ruger  
24 PC9?  
25 A That they can be interchangeable.

Page 78

1 Q How do you know that?  
2 A YouTube.  
3 Q Have you ever done it yourself?  
4 A Not yet.  
5 Q So you relied on a YouTube video, watching a  
6 YouTube video, to make the determination in paragraph 6C  
7 that the Ruger PC9 can take magazines from the P85 and P89;  
8 is that right?  
9 A Yes.  
10 Q I'm going to direct your attention to  
11 paragraph 6D. Do you see it says, "As to the Springfield  
12 Armory XD series, it's actually a Croatian-made pistol,  
13 made by HS Produkt, and the magazines it uses are largely  
14 interchangeable with the Beretta M-92 series, except that  
15 one needs to cut a single notch in the XD magazines to make  
16 them work in the M-92 or a single notch in an M-92 Beretta  
17 magazine to make them work in an XD."  
18 Is that your testimony?  
19 A Yeah.  
20 Q When you say cut a notch, what do you mean?  
21 A Have you ever used a mill?  
22 Q What kind of mill?  
23 A A Bridgeport.  
24 Q I have not personally.  
25 A Okay. So if you have the right sized end

Page 79

1 mill, you can put it in your -- an end mill is a cutting  
2 tool you insert in the mill which provides the power, put  
3 it in the vise and if you measure the distance right, you  
4 cut the notch in it and then it will lock into place and  
5 hold.  
6 Q So you have to use a mill and a vise to  
7 physically cut a notch in a magazine; is that right?  
8 A There are probably other methods, but that's  
9 how I did it.  
10 Q And if you don't cut that notch in the  
11 magazine using the mill and using the vise, then that  
12 magazine won't actually be interchangeable; is that right?  
13 A I think it depends on anyone's individual  
14 skills.  
15 Q What do you mean?  
16 A The reason that I would use the mill and the  
17 vise is, it is a rigid setup and won't move. If you did it  
18 by hand, the results may not be the same every time.  
19 Q So you can either use a mill with a vise or  
20 make the single cut by hand, is that what you're saying?  
21 A You could, yes.  
22 Q But you would still have to make that cut in  
23 order for the magazine to be interchangeable between the  
24 Springfield Armory XD series and the Beretta M-92?  
25 A Yes.

Page 80

1 Q So you actually have to physically modify the  
2 magazine?  
3 A Yes.  
4 Q And the Beretta M-92 and Springfield Armory XD  
5 series, those are both handguns; right?  
6 A Yes.  
7 Q So the 15-round capacity limit would apply to  
8 both of those firearms under PICA; right?  
9 A Yes.  
10 Q When you're buying a magazine for a specific  
11 handgun, it is possible to know how many rounds of  
12 ammunition of a particular caliber that magazine will hold;  
13 correct?  
14 A Yeah. Usually when you order them that way.  
15 Q When you're buying a magazine for a specific  
16 handgun, it is possible to buy a magazine of 15 rounds or  
17 less; correct?  
18 A Read that back, please.  
19 (The requested portion of the  
20 record read by the reporter.)  
21 MR. MAAG: For which handgun?  
22 Q (By Mr. Wells) For the handgun that you own  
23 and that you use.  
24 A Yes.  
25 Q And when you're buying a magazine for a

Page 81

1 specific rifle, it is possible to know how many rounds of  
2 ammunition of a particular caliber that magazine will hold?  
3 A Yes, as advertised.  
4 Q When you're buying a magazine for a specific  
5 rifle, it is possible to buy a magazine of 10 rounds or  
6 less; correct?  
7 MR. MAAG: For which rifle?  
8 Q (By Mr. Wells) A rifle that the manufacturer  
9 offers a 10-round magazine, you can purchase the 10-round  
10 magazine for that rifle; is that fair to say?  
11 A Are you asking as the manufacturer of the  
12 rifle or are you asking as a manufacturer that is  
13 aftermarket?  
14 Q Not aftermarket.  
15 A Okay.  
16 Q Can you read back the question?  
17 (The requested portion of the  
18 record read by the reporter.)  
19 A Yes.  
20 Q What is an AR-type rifle?  
21 A I think that's a generic term.  
22 Q What do you mean by generic term?  
23 A I don't think it's defined by law and I think  
24 it's overly broad.  
25 Q How is it overly broad?

Page 82

1 A I think there's a whole lot of things swept  
2 into it that are not related to the AR-15 ArmaLite rifle.  
3 Q What are those things?  
4 A Over time, there are other manufacturers that  
5 kind of adjusted things to get off the patent, so I don't  
6 think everything that advertises AR is an AR. And then  
7 when you get to doing that, I think you've got to really do  
8 your homework to make sure that what you are buying and  
9 what you are buying to fit will fit because sometimes they  
10 have changed pins, sometimes they have added screws. I  
11 don't -- I don't think there's such a thing -- In my mind,  
12 I don't think there's a blanket AR-type.  
13 Q When you mentioned a patent, what are you  
14 referring to?  
15 A The patents held at the U.S. Patent Office.  
16 Q But which specific patent?  
17 A I don't have a specific patent. I'm just  
18 trying to -- are you familiar when -- before World War I,  
19 Springfield Armory or the U.S., they stole the 9-bolt  
20 locking lug from Mauser.  
21 Q I wasn't aware of that. But let's refocus  
22 on --  
23 A But, like, paying royalties. So if you ripped  
24 off somebody's patent and the patent hasn't expired yet,  
25 you are obligated to pay royalties. So if you change

Page 83

1 things just a little bit, you get around that.  
2 Q Right, so -- But you were referring to a  
3 specific patent for the AR-15?  
4 A No, not -- Yes. Okay.  
5 Q Is that right?  
6 A Yes.  
7 Q So when you said patent earlier, you were  
8 referring to a specific patent for the AR-15 rifle. Is  
9 that the AR-15 rifle that was originally designed by Eugene  
10 Stoner?  
11 A In '57 I think, yeah.  
12 Q And then do you know who had the patent for  
13 the AR-15?  
14 A No.  
15 Q Colt, does that sound right?  
16 A I think so.  
17 Q And when you said patent, is that generally  
18 what you were referring to, that design?  
19 A Yeah.  
20 Q And as I understood what you were saying,  
21 manufacturers have come along and looked at that design and  
22 made little changes to it over time; is that right?  
23 A Yes. They have made changes in I guess I want  
24 to say structure and materials. Man, materials have  
25 changed so much since the '50s.

Page 84

1 Q And eventually, is it your testimony, that so  
2 many changes over time may push you so far beyond that  
3 original design that you've got something different; is  
4 that right?  
5 A I think so.  
6 Q But there still is an original AR-15 and you  
7 know what that is; right?  
8 A The Colt you referenced.  
9 Q And are there firearms on the market today  
10 that you would agree are properly called an AR-15?  
11 A On the market today?  
12 Q Yes.  
13 A That could be purchased by me today?  
14 Q Not purchased in Illinois, but just available  
15 in the market in the United States?  
16 A In my mind, no.  
17 Q There's nothing called an AR-15 on the market  
18 today?  
19 A They can call it what they want, but I don't  
20 think it's the AR-15.  
21 Q What do you think it is?  
22 A It's like the evolution from a 1950s pickup to  
23 what you've got today. It's a different animal.  
24 Q But you agree that there's a line in that  
25 evolutionary trajectory that goes back to Eugene Stoner's

Page 85

1 design from the 1950s; is that right?  
2 A Sort of like roots. Yeah, you could say that.  
3 Q Have you ever seen just the letters A-R used  
4 to describe a firearm?  
5 A Seen them? I don't think so.  
6 Q Have you ever heard people just refer to an  
7 AR?  
8 A I think so.  
9 Q What did you understand that to mean?  
10 A I didn't know what they meant because I don't  
11 know one.  
12 Q Did you have any idea what those two letters  
13 meant together?  
14 A ArmaLite Rifle.  
15 Q When you -- And you have heard somebody say  
16 AR?  
17 A Oh, yeah.  
18 Q And did you have any sense of what they were  
19 talking about?  
20 A I'm sure they are referring to their rifles.  
21 Q And what rifles did you understand them to be  
22 referring to?  
23 A I didn't see them.  
24 Q Without having seen them, did you have an idea  
25 in your head?

Page 86

1 A I can't recall visualizing anything.  
2 Q When you heard people use the term AR, is it  
3 your testimony that you had no idea what make, model,  
4 caliber of rifle they were talking about?  
5 A Wasn't concerned.  
6 Q Did you have any idea what type of rifle they  
7 were talking about when they used the term AR?  
8 MR. MAAG: Objection. Asked and answered  
9 about five times now.  
10 Q (By Mr. Wells) You can answer.  
11 A I wasn't concerned. Dad forbid me from owning  
12 one, so I didn't invest a lot of time looking into it.  
13 Q And your dad forbid you from owning the AR-15,  
14 which became the M-16, because it failed in Vietnam; is  
15 that right?  
16 A Right.  
17 Q So you understood that people were referring  
18 to that rifle, the AR-15, when they said AR; is that right?  
19 A You mean the AR-15 to the M-16?  
20 Q When you had the thought in your head that  
21 your dad forbid you from getting an AR-15.  
22 A Uh-huh (yes).  
23 Q You associated that thought with when you  
24 heard the term AR; is that right?  
25 A Yeah. I still wasn't interested in owning one

Page 87

1 so I didn't put a lot of stock into it.  
2 Q Did I hear you say yes?  
3 A No, you did not.  
4 Q So you were not connecting -- Never mind.  
5 I'll withdraw that question. What number are we on?  
6 THE REPORTER: Six.  
7 (Deposition Exhibit No. 6 marked for  
8 identification.)  
9 Q (By Mr. Wells) I'm showing you what has been  
10 marked as Deposition Exhibit 6. It's an excerpt of  
11 Shooter's Bible Guide to AR-15s.  
12 A Okay.  
13 Q Got the full book here in person, but I'm  
14 going to just focus on these excerpts to keep it simple.  
15 Are you familiar with the Shooter's Guide -- the Shooter's  
16 Bible, generally?  
17 A Not very much.  
18 Q But you said you had looked at a Shooter's  
19 Bible?  
20 A I have seen them, but I haven't spent a lot of  
21 time looking at them.  
22 Q Just remember to let me finish the question,  
23 if you don't mind.  
24 A My bad.  
25 Q So I'm going to direct your attention to the

Page 88

1 last page of this exhibit. Okay. Do you see how it  
2 identifies the author, one author, as Doug Howlett? Do you  
3 see that?  
4 A Yes, the first one in red.  
5 Q Yes. And do you see that it says that Doug  
6 Howlett used to work for the National Rifle Association  
7 where he worked as an assistant editor of American Hunter  
8 Magazine? Do you see that?  
9 MR. MAAG: Are you asking him if the document  
10 says that?  
11 Q (By Mr. Wells) I'm asking him if he sees it.  
12 A In the same paragraph where it says Doug  
13 Howlett?  
14 Q Yes.  
15 A Yes.  
16 Q And you subscribe to the American Rifleman,  
17 which is an NRA publication; right?  
18 A Yes.  
19 Q So the NRA knows what it's talking about when  
20 it's talking about firearms?  
21 A I hope so.  
22 Q And you see that Rob Howling -- I'm sorry, Rob  
23 Manning. Do you see he's the current editor of Gun World  
24 Magazine, at least as of the publication of this book?  
25 A Yes, the last paragraph -- or last sentence.



Page 89

1 Q Are you familiar with Gun World Magazine?  
2 A No.  
3 Q Okay. I'm going to direct your attention to  
4 the second paragraph here. Do you see where it says, "In  
5 the complete book of AR-style firearms, you can peruse the  
6 products of all manufacturers, learn about the evolution of  
7 the AR from its uses in the military in the 1960s as well  
8 as gain essential knowledge on the parts and functions of  
9 the rifle"?

10 Do you have an understanding of what AR-style  
11 firearms means in this sentence?  
12 A The way he led it out, yes.  
13 Q What is that understanding?  
14 A That his book outlines the evolution of the  
15 AR.  
16 Q When you say AR, what do you mean?  
17 A That's what it says, AR.  
18 Q But when you say AR, what do you mean?  
19 A I'm referring to what it says here, AR.  
20 Q Okay. Do you see in the next sentence, it  
21 says, "Also included are chapters on customizing,  
22 accessorizing ARs and much more."  
23 Do you see that?  
24 A Yes.  
25 Q Do you have an understanding as to what ARs

Page 90

1 means in that sentence?  
2 A Yes, it's something you can spend money on.  
3 Q Is it a firearm?  
4 A In the first sentence, it says AR-style  
5 firearms, so I'm assuming that's his reference.  
6 Q So from this context you can understand what  
7 the phrase ARs means?  
8 A Phrase? Yes.  
9 Q Okay. I'm going to direct your attention  
10 earlier in the exhibit to the page labeled contents. Do  
11 you see under chapter four, it says AR rifle models?  
12 A Chapter four? Chapter four, yep.  
13 Q Do you have an understanding as to what AR  
14 rifle models means?  
15 A Not yet.  
16 Q Do you have any idea what you think AR rifles  
17 models might mean?  
18 A Not until after I read the chapter.  
19 Q Let's take a look at the chapter. I'm going  
20 to direct your attention --  
21 A Page 51?  
22 Q -- to page 51. Directing your attention to  
23 where it says AR rifle models and then the first sentence.  
24 It says, "Following is undoubtedly the most comprehensive  
25 listing of current AR-style rifle models available in print

Page 91

1 or on the web, though it is by no means exhaustive."  
2 Do you have an understanding as to what the  
3 phrase AR-style rifle models means in this sentence?  
4 A Yeah, it's referring to everything underneath.  
5 Q Directing your attention to the last sentence  
6 in that paragraph. "And admittedly, with so many small gun  
7 makers coming into the fold, and just as quickly falling  
8 back out of it, capturing every manufacturer is a target  
9 even a custom-built AR couldn't hit."  
10 Do you see that?  
11 A No. The last -- I'm sorry. Yes.  
12 Q Do you understand what the phrase custom-built  
13 AR means in that sentence?  
14 A Maybe.  
15 Q What do you think your understanding is?  
16 A That he is outlining his preferred way to  
17 modify these rifles.  
18 Q Do people sometimes build their own AR rifles?  
19 A I think so.  
20 Q Do you know anybody who builds their own AR  
21 rifles?  
22 A Maybe.  
23 Q Who is that?  
24 A I think his name was Bob Updike.  
25 Q And you were aware that he custom built his

Page 92

1 own ARs?  
2 A Well, from this article, that makes sense.  
3 Q But out in the world in your knowledge of, you  
4 know, talking to people at the range, for instance, you're  
5 aware that people custom build their own ARs; is that  
6 right?  
7 A Well, I guess they can.  
8 Q But you're aware that they do?  
9 A I hadn't watched them modify anything, so I  
10 don't know.  
11 Q Have you ever heard anybody mention that they  
12 built their own AR?  
13 A I don't know.  
14 Q Direct your attention to what's labeled as  
15 Appendix 1. Do you see that? So it's page 225.  
16 MR. MAAG: 2-2-5?  
17 Q (By Mr. Wells) 2-2-5. And we are still on  
18 Exhibit 6, Shooter's Bible Guide to AR-15s. So I'm just  
19 going to ask you to look at this briefly, and it says AR  
20 manufacturers.  
21 A Got it.  
22 Q What do you think that means?  
23 A Who they are -- who the author believes  
24 manufactures ARs.  
25 Q ARs means firearms in this context; is that

Page 93

1 right?  
2 A I believe so.  
3 Q And specific types of firearms, like the  
4 AR-15; is that right?  
5 A It just says AR.  
6 Q Looking at this list, I counted 141  
7 manufacturers. I'm not going to ask you to count. Is it  
8 fair to say that there are a lot of manufacturers of  
9 AR-type firearms?  
10 A Yes.  
11 Q And the fact that there are lots of  
12 manufacturers, do you think it's fair to say that that's a  
13 reflection of the popularity of AR-type firearms?  
14 A It would have to be, because they would have  
15 to be in business to make money.  
16 Q You mentioned this earlier, but just to  
17 clarify, when you're referring to the AR-15, what does the  
18 AR stand for?  
19 A ArmaLite Rifle.  
20 Q What's the 15 mean?  
21 A My guess is 15th try.  
22 Q You said you wanted to potentially acquire an  
23 AR-10 rifle?  
24 A Yes.  
25 Q What's an AR-10 rifle?

Page 94

1 A 308.  
2 Q Can you explain what you mean?  
3 A It chambers 308.  
4 Q How else would you describe an AR-10 rifle?  
5 A Cheap to shoot.  
6 Q It's cheap to shoot and it's chambered in --  
7 what did you say?  
8 A 308.  
9 Q What did the AR in AR-10 stand for?  
10 A I don't know.  
11 Q Do you know which one is more popular, an  
12 AR-10 or an AR-15 rifle?  
13 A I don't know.  
14 Q Do you own an AR-7 rifle?  
15 A No.  
16 Q Do you have any plans to purchase an AR-7  
17 rifle?  
18 A Not right now.  
19 Q Did you have any plans to purchase an AR-7  
20 rifle before January 10th, 2023?  
21 A Yeah.  
22 Q When did you develop those plans?  
23 A During COVID.  
24 Q Why did you want to purchase an AR-7 rifle  
25 during COVID?

Page 95

1 A Because I didn't have one.  
2 Q What were you intending to do with the AR-7  
3 rifle that you were planning to purchase during COVID?  
4 A Collect.  
5 Q Anything else?  
6 A No.  
7 Q All right. I'm going to direct your attention  
8 to Exhibit 2. You can set that to the side for right now.  
9 So back to your June 27, '23 declaration,  
10 paragraph 12. I'm reading from your declaration. It says,  
11 "I am familiar with the AR-7 rifle. A photograph is shown  
12 below."  
13 Do you see that?  
14 A Oh, I was looking at the wrong paragraph. I'm  
15 sorry. Yes.  
16 Q Where did that picture come from under  
17 paragraph 12?  
18 A I don't know.  
19 Q So you personally didn't --  
20 A I didn't pick that photo, no.  
21 Q You personally did not pick this photo in  
22 paragraph 12; is that right?  
23 A Correct.  
24 Q I'm directing your attention to paragraph 15,  
25 at the bottom. In paragraph 15, you say -- and this is in

Page 96

1 reference to the firearms depicted in paragraphs 12 and 13.  
2 "I acknowledge there are both handgun and  
3 rifle versions of this firearm;" -- meaning the AR-7 --  
4 "however, other than the AR-7 marking, I see no reason why  
5 under the challenged act" -- referring to PICA -- "this  
6 firearm cannot be sold or possessed unless this is, in  
7 quote, AR-type, close quote, firearm, which while marked as  
8 an AR-7, I have no idea and to not see how to discern  
9 whether this is an AR-type firearm."  
10 I think it meant "do not see how to discern  
11 whether this is an AR-type firearm." So based on what you  
12 testified -- And that's your testimony in paragraph 15; is  
13 that right?  
14 A Yes.  
15 Q And based on paragraph 15, the only reason you  
16 have a question about whether this firearm is covered by  
17 the Act is because AR is in the name; is that right?  
18 A Right.  
19 Q Other than AR being in the name, you see, "no  
20 reason why this firearm cannot be sold or possessed;" is  
21 that right?  
22 A Correct.  
23 Q You agree that the AR-7 depicted in paragraph  
24 13 does not have any of the prohibited features listed in  
25 the first definition of assault weapon in PICA; right?



Page 97

1 A Correct.

2 Q And specifically I'm referring to 720 ILCS

3 5/24-91A1, capital A. You're familiar with what I'm

4 referring to when I say the features list in that statutory

5 provision?

6 A You called it the futures list?

7 Q Features.

8 A Features. It's been a while since I read it,

9 so I don't remember the details.

10 Q What number are we on?

11 A Seven.

12 Q Good memory.

13 (Deposition Exhibit No. 7 marked for

14 identification.)

15 Q (By Mr. Wells) I'm showing you what's been

16 marked as Deposition Exhibit 7, which I can represent to

17 you is 720 ILCS 5/24-1.9, and I'm directing your attention

18 to (a)(1)(A). You can take a look at that.

19 A Here.

20 Q So when I asked you earlier whether or not the

21 AR-7 had any of the features listed in section -- in PICA,

22 I was referring to 1.9(a)(1)(A).

23 A Uh-huh (yes).

24 Q And you agree that the AR-7 as depicted in

25 paragraph 12 of your declaration does not have any of these

Page 98

1 features that are listed in the statute?

2 A I think it's a pistol grip.

3 Q So now your testimony is that you think what's

4 depicted in paragraph 12 is a pistol grip?

5 A It doesn't have the -- like, the straight back

6 stock.

7 Q But your prior testimony was that it did not

8 have any of the features in PICA; is that right?

9 A Correct.

10 Q So you're changing your testimony, that the

11 AR-7 is now covered by PICA?

12 A I forgot what was in there. There's so much

13 into it it's hard to remember every detail.

14 Q Would you agree that an AR-7 is a very

15 different rifle than an AR-15?

16 MR. MAAG: Objection. Vague. You can answer.

17 A Looks to be.

18 Q (By Mr. Wells) Do you know how many companies

19 make an AR-7 rifle today?

20 A No.

21 Q So according to Wikipedia, only the Henry

22 Repeating Arms Company makes an AR-7 today. Does that

23 sound about right to you?

24 A That means it ought to be a pretty good rifle.

25 Q Do you own an AR-5 rifle?

Page 99

1 A No.

2 Q Why not?

3 A Don't have money.

4 Q Did you ever have any intent to buy an AR-5

5 rifle?

6 A No.

7 Q I'm directing your attention to paragraph 17

8 and 18 of your declaration, your June 27th declaration,

9 where you say, "I'm also aware of a firearm called an AR-5.

10 Below is a photograph."

11 Do you see that?

12 A I do.

13 Q And then in paragraph 18, you wrote, "This is

14 a bolt-action firearm with a four-round magazine."

15 A Yes.

16 Q So that AR-5 that's depicted there is a

17 bolt-action firearm; is that right?

18 A That's what I see.

19 Q Bolt-action is different than semi-automatic;

20 right?

21 A Yes.

22 Q And, again, you say, "I do not know if this,"

23 meaning the AR-5, "is included in the definition of an

24 AR-type firearm."

25 Is that right?

Page 100

1 A Yes.

2 Q Is the reason that you're confused is because

3 the letters AR appear in the AR-5 name?

4 A Yes.

5 Q Are there any other reasons?

6 A Nothing I can think of.

7 Q Do you have an understanding as to whether or

8 not this AR-5 is covered by PICA, as to whether it's

9 defined as an assault weapon under PICA?

10 A I don't think it is.

11 Q Directing your attention to Deposition

12 Exhibit 7. So that's the statute. You got it in your

13 hand. Section 1.9. So it's got page numbers at the bottom

14 right. You can flip to page five. Okay. So directing

15 your attention to where it says two.

16 MR. MAAG: What page are we on?

17 Q (By Mr. Wells) Page five. And for the record,

18 this is Section 1.9 A2 capital-- I'm sorry. 2A2. Do you

19 see where it says, assault weapon does not include, and

20 then it's got an A and then a B, and then C says, "A

21 firearm that is manually operated by bolt-pump lever or

22 slide action, unless the firearm is a shotgun with a

23 revolving cylinder."

24 Do you see that?

25 A Yes.

Page 101

1 Q And that AR-5 that we were just talking about  
2 in paragraph 17 of your declaration, it's a firearm that's  
3 operated by bolt; is that fair to say?  
4 A Yes.  
5 Q So it would specifically be excluded from the  
6 definition of assault weapon under PICA?  
7 MR. MAAG: Objection. Calls for a legal  
8 conclusion.  
9 Q (By Mr. Wells) Is that your understanding?  
10 MR. MAAG: Same objection.  
11 A Yes.  
12 Q (By Mr. Wells) So now I'm directing your  
13 attention to paragraph 19 and then the picture below it --  
14 pictures below it. Do you see that?  
15 A Yes.  
16 Q And then paragraph 19 you say, "In addition,  
17 some firearms that look kind of like an AR-15 are  
18 bolt-action or straight pull bolt-action, not  
19 semi-automatic."  
20 Do you see that?  
21 A Yes.  
22 Q And directing your attention to what's marked  
23 as page six in this exhibit, at the top, six of 43, there  
24 are actually two pictures here. Do you see that?  
25 A Yes.

Page 102

1 Q And is it fair to say that both of the two  
2 pictures in here show firearms that are bolt-action  
3 firearms -- or, I'm sorry, pump-action firearms.  
4 (The requested portion of the  
5 record read by the reporter.)  
6 Q (By Mr. Wells) Let me repeat the question for  
7 you. Is it fair to say that the two pictures on page six  
8 of 43 of Exhibit 2 are pump-action firearms?  
9 A No. One is pump, one's bolt.  
10 Q Okay. Is the top one pump or bolt?  
11 A Bolt.  
12 Q Is the bottom one pump or bolt?  
13 A Pump.  
14 Q So the two firearms depicted here are either  
15 pump-action or bolt-action; is that fair to say?  
16 (The requested portion of the  
17 record read by the reporter.)  
18 A I think so.  
19 Q Neither one of them depicted on page six of 43  
20 is semi-automatic; right?  
21 (The requested portion of the  
22 record read by the reporter.)  
23 A I'm not sure.  
24 Q (By Mr. Wells) Did you find these pictures  
25 yourself?

Page 103

1 A No.  
2 Q Do you know where these pictures come from?  
3 A No.  
4 Q Have you ever seen these pictures before?  
5 A Yes.  
6 Q When you described the pictures on the  
7 following page in paragraph 19 --  
8 A The following page?  
9 Q So go back one.  
10 A The previous page?  
11 Q The previous page. "In addition, some  
12 firearms that look kind of like an AR-15 are bolt-action or  
13 straight pull bolt-action, not semi-automatic. A  
14 photograph of one such firearm is shown below."  
15 So you just described these pictures as  
16 bolt-action or straight pull bolt-action; is that right? I  
17 see what the problem is. I'm messing you up.  
18 Paragraph 19, you're referring to the  
19 photograph at the top of the page that's marked six of 43;  
20 is that right?  
21 A That was the confusion.  
22 Q And that's what you were referring to in  
23 paragraph 19, the photo at the top of page six which you  
24 describe as a bolt-action, the paragraph at the top of page  
25 six is a bolt-action rifle; correct?

Page 104

1 A I believe it is.  
2 Q Okay. Let's look at paragraph 20 now, the  
3 next page.  
4 A Okay. So -- Got it.  
5 Q Then paragraph 20, there's a picture  
6 immediately above paragraph 20. And paragraph 20 says,  
7 "There have also been pump-action firearms that look like  
8 AR-15 rifles. A photograph of one such rifle is shown  
9 above."  
10 Do you see that?  
11 A I do.  
12 Q And that firearm that's depicted immediately  
13 above paragraph 20 is a pump-action firearm; is that right?  
14 A That's what it appears to be.  
15 Q And when you said in paragraph 20, firearms  
16 that look like AR-15 rifles, you had an understanding of  
17 what an AR-15 rifle was?  
18 A With these pictures, yes.  
19 Q How does the firearm depicted in paragraph 20,  
20 immediately above paragraph 20, look like an AR-15 rifle?  
21 A They have a similar silhouette.  
22 Q What do you mean by silhouette?  
23 A The best way I can describe it is a shadow or  
24 an outline.  
25 Q So the shape of the firearm; is that fair to

Page 105

1 say?  
2 A Yes.  
3 Q And the reason the shape of the firearm  
4 depicted above paragraph 20 is similar to an AR-15 is  
5 because there's a pistol grip; is that right? That's one  
6 of the reasons?  
7 A Yeah. They look like they have a similar mag  
8 well.  
9 Q Similar mag well. How about the buttstock, is  
10 that similar?  
11 A Kind of.  
12 Q What about the flash suppressor, is that  
13 similar to an AR-15 flash suppressor?  
14 A I don't know.  
15 Q Well, when you wrote this, and you said that  
16 this pump-action firearm depicted above paragraph 20 looks  
17 like an AR-15 rifle, what did you mean?  
18 A The silhouette. I mean, at first glance.  
19 Q At first glance what?  
20 A Have you ever got a Belgian Malinois confused  
21 with a German Shepherd?  
22 Q I think you can just answer my question.  
23 A That's what I mean, the characteristics are  
24 similar, look similar.  
25 Q So this -- this picture and -- Above paragraph

Page 106

1 20 looks similar to an AR-15 rifle; is that right?  
2 MR. MAAG: Misstates his testimony. The  
3 affidavit says kind of like.  
4 Q (By Mr. Wells) You can answer.  
5 A Yes.  
6 Q And when you say it looks kind of like an  
7 AR-15 rifle, you have an idea in your head of what an AR-15  
8 rifle looks like; is that right?  
9 A I do.  
10 Q And as we discussed, this is a pump-action  
11 firearm in -- depicted immediately above paragraph 20; is  
12 that right?  
13 A That's what it looks like, yes.  
14 Q And directing your attention back to PICA  
15 Section 1.9, Deposition Exhibit 7. So back to the middle  
16 of the page.  
17 A Okay.  
18 Q It says, "Assault weapon does not include,"  
19 and then sub C, "a firearm that is manually operated by  
20 bolt, pump, lever or slide action unless the firearm is a  
21 shotgun with a revolving cylinder."  
22 So you would agree that the firearm depicted  
23 in paragraph -- or immediately above paragraph 20 is a  
24 pump-action firearm; is that right?  
25 A That's what it looks like.

Page 107

1 Q Is it a shotgun with a revolving cylinder?  
2 A It doesn't look like it.  
3 Q So the paragraph, as far as you understand --  
4 or, I'm sorry. The firearm depicted immediately above  
5 paragraph 20, it would not be an assault weapon under PICA,  
6 is that your understanding?  
7 MR. MAAG: Objection. Calls for a legal  
8 conclusion. You can answer.  
9 A It kind of looks that way.  
10 Q (By Mr. Wells) The firearm depicted above  
11 paragraph 20, do you have any -- did you, prior to PICA,  
12 when it took effect on January 10, 2023, were you intending  
13 to purchase this firearm?  
14 A No.  
15 Q If PICA were struck down today, would you go  
16 out and purchase this firearm depicted above paragraph 20?  
17 A Maybe some day.  
18 Q But how about today?  
19 A Today, I don't have a need for it.  
20 Q Before you prepared your June 27, 2023,  
21 affidavit, had you read the exception for bolt and  
22 pump-action rifles -- or, I'm sorry, bolt and pump-action  
23 firearms in Section 1.9A2C, shown in Exhibit 7?  
24 A Here. Yeah. I remember reading this.  
25 Q Before you selected the examples that you

Page 108

1 included?  
2 A Well, I read this before J.B. signed it, so --  
3 Sorry. Would you repeat his question?  
4 Q So let me just --  
5 MR. MAAG: I think you've answered his  
6 question.  
7 Q (By Mr. Wells) Yeah. You said you read the  
8 statute before J.B., meaning Governor Pritzker, signed the  
9 statute; is that right?  
10 A Right.  
11 Q So let me direct your attention to page two of  
12 Exhibit 7. So directing your attention to the subpart  
13 where it says AR-types. So subpart J(ii), little Roman  
14 two. Do you see that?  
15 A Yeah. I'm with you.  
16 Q So you've been following this legislation even  
17 before it was signed into law; is that right?  
18 A Yes.  
19 Q And you're familiar with the firearms listed  
20 under all AR-types on page two of paragraph seven; is that  
21 right?  
22 A Not completely.  
23 Q I would ask you to take a look at the list  
24 under subpart J, small Roman two, continuing on to page  
25 three, and tell me which of the firearms on this list you

Page 109

1 don't think are AR-types?  
2 MR. MAAG: Objection. Calls for a legal  
3 conclusion.  
4 A I don't know how to answer that because I  
5 haven't seen all of these.  
6 Q (By Mr. Wells) Are there -- So you have not  
7 seen all of these firearms, so you can't comment on whether  
8 or not they are AR-types?  
9 A Right.  
10 MR. MAAG: The statute is defining those all  
11 as AR.  
12 MR. WELLS: Tom, if you have an objection, you  
13 can state it, but we don't need you to testify.  
14 MR. MAAG: Yeah. Objection to the form of  
15 your question. It misstates the statute.  
16 Q (By Mr. Wells) Reviewing the list and the  
17 statute, subsection J(ii), under all AR-types, are there  
18 firearms in this list that you don't think are properly  
19 called an AR-type?  
20 A Definitely on little Roman numeral one, at 6,  
21 SKS with detachable magazine, so --  
22 Q That's under AK-type, though; correct?  
23 A Is that what you were asking?  
24 Q No, I was asking about AR-type.  
25 A I'm confused. Can we start over?

Page 110

1 Q Can you review the list under section J(ii)?  
2 A Oh, you're on ii. J(ii). J(ii). J(ii).  
3 Q Yeah, where it says all AR-types. Can you  
4 review the list and tell me which of the listed firearms  
5 you don't believe are AR-types?  
6 A I'm going to say number -- Roman Numeral four.  
7 Roman Numeral 37.  
8 MR. MAAG: Did you say 37 or seven?  
9 A Thirty-seven, the --  
10 Q (By Mr. Wells) Smith & Wesson M&P rifles --  
11 M&P 15 rifles?  
12 A Yeah.  
13 MR. MAAG: Got it.  
14 Q (By Mr. Wells) You can stop before you get to  
15 subpart little iii.  
16 A All right. I stopped --  
17 Q You stopped at XL?  
18 A I stopped there.  
19 Q You stopped at XLIII, which is Roman numeral  
20 43, do you see that?  
21 A Okay. Roman Numeral 43. All right.  
22 Q So I've just asked you to review --  
23 A That's where it stops.  
24 Q J(ii), Roman Numeral one through Roman numeral  
25 43 and you have identified two firearms that you don't

Page 111

1 think are properly characterized as an AR-type; is that  
2 right?  
3 A Correct.  
4 Q And the two that you have identified are the  
5 ArmaLite M-15 .22 LR carbine and the Smith & Wesson M&P 15  
6 rifles; is that right?  
7 A Correct.  
8 Q So for the other 41, at least as you sit here  
9 today, you don't have any reason to think they are not  
10 AR-types?  
11 A I don't have any reason to think they are,  
12 either.  
13 Q But as you sit here today, they are not one of  
14 the rifles that you've identified as definitely not being  
15 an AR-type; is that fair to say?  
16 A Correct.  
17 Q And when I asked you to look at that list and  
18 you selected two of the 43, which you don't think are  
19 properly characterized as an AR-type, you had an idea in  
20 your mind as to what AR-type meant; right?  
21 A After our discussion and the pictures, yes.  
22 Q I'm directing your attention to paragraph 10  
23 of your June 27th affidavit. So Exhibit 2. In paragraph  
24 10 you say, "At one point, likewise, there are no objective  
25 standards to determine whether a given firearm is an

Page 112

1 AK-type, an AR-type or something else."  
2 MR. MAAG: Did you say paragraph 10?  
3 MR. WELLS: Paragraph 10.  
4 MR. MAAG: Of which exhibit?  
5 MR. WELLS: I might have the wrong one. I  
6 think I do.  
7 MR. MAAG: Because what I read doesn't say  
8 what you just said.  
9 MR. WELLS: Yeah. You're right. You're  
10 right. Give me a second here.  
11 MS. HELFRICH: Do you want me to look for it?  
12 Q (By Mr. Wells) Yeah. I'm sorry. It was your  
13 other one. So we're back to --  
14 A Exhibit 1?  
15 Q Yeah. So paragraph 10 of Exhibit 1. Do you  
16 see where it says, "Likewise, there are no objective  
17 standards to determine whether a given firearm is an  
18 AK-type, an AR-type or something else. In fact, even the  
19 listed examples are oftentimes not within the parameters of  
20 what even most firearms experts would consider to be an  
21 AK-type, like the SKS of an AR-type."  
22 Is that your testimony?  
23 A Yes.  
24 Q You do believe there are quote, parameters,  
25 close quote, for what most firearms experts would consider

Page 113

1 an AR-type; correct?  
2 A Correct.  
3 Q In your mind, what are the parameters that  
4 most firearms experts would consider to be an AR-type?  
5 A I don't know. I haven't talked to any of  
6 them.  
7 Q Your testimony was, though --  
8 A Uh-huh (yes).  
9 Q -- that most firearms experts would consider  
10 certain parameters?  
11 A Uh-huh (yes).  
12 Q You haven't talked to any, though?  
13 A They have their opinion, but I don't know what  
14 their opinion is.  
15 Q But you're aware that there are firearms  
16 experts out there who have a set of parameters in their  
17 mind to refer to an AR-type?  
18 A Yes.  
19 Q And you're aware that that -- Well, let me  
20 strike that. In your mind, what are the parameters that  
21 most firearms experts would consider to be an AR-type?  
22 A I don't have an answer.  
23 Q When we went through the list and the statute,  
24 you identified the ArmaLite M-15 .22 LR carbine. Why do  
25 you think that the ArmaLite M-15 .22 LR carbine is not an

Page 114

1 AR-type?  
2 A Because it uses .22 magnum -- or not -- .22  
3 long rifle.  
4 Q How does that make it not an AR-type?  
5 A Because it's not using 7.62.  
6 Q Why does 7.62 ammunition make something an  
7 AR-type?  
8 A And I also think that thing is made out of  
9 plastic.  
10 Q So it's a different caliber than what you  
11 typically think of as an AR-type; is that fair to say? I'm  
12 referring to the ArmaLite M-15 .22 LR carbine.  
13 A Yes.  
14 Q And the other thing that you have just  
15 mentioned is that the ArmaLite M-15 .22 LR carbine is made  
16 out of plastic and that's different than --  
17 A Polyethylene, I think. I'm sorry.  
18 Q The ArmaLite M-15 .22 LR carbine is made out  
19 of polyethylene, whereas other AR-type rifles are made out  
20 of a different material; is that fair to say?  
21 A Yes.  
22 Q Are there any other differences that you can  
23 think of?  
24 A No.  
25 Q How about the Smith & Wesson M&P 15 rifles,

Page 115

1 why do you believe those are not properly called an  
2 AR-type?  
3 A I think they are also a polyethylene compound.  
4 Q So the materials that are used to make the  
5 frame and receiver of the rifle?  
6 A Yes. Yes.  
7 Q Are there any other reasons why the  
8 Smith & Wesson M&P 15 rifles should not be classified as an  
9 AR-type in your mind?  
10 A No.  
11 Q All right. I'm going to -- Let's see. How  
12 long -- Let me know if you need a break, remember?  
13 A Thank you.  
14 Q Are you familiar with a Daniel Defense M4 V7?  
15 A I remember the name of the company.  
16 Q So we are on --  
17 A Eight.  
18 (Deposition Exhibit No. 8 marked for  
19 identification.)  
20 Q (By Mr. Wells) I'm marking Deposition  
21 Exhibit 8, which I can represent to you is a printout from  
22 Daniel Defense's website. It's got the URL at the bottom.  
23 Do you recognize the DDM4 V7? Have you seen this firearm  
24 before?  
25 A I think I have.

Page 116

1 Q Where have you seen it?  
2 A I think it was Indy, Indianapolis.  
3 Q Where? In what context?  
4 A I was shown a collection. I think it was that  
5 one.  
6 Q And you testified earlier that you sometimes  
7 look at manufacturers' websites for information about  
8 firearms; is that right?  
9 A Yes.  
10 Q All right. I'm directing you to page two --  
11 A Of which exhibit?  
12 Q -- of this exhibit. The one you've got in  
13 your hand. Do you see under details, where it says, "The  
14 DDM4 V7 AR-15 style firearm features M-LOK attachment  
15 technology with the Daniel Defense MFR 15.0 rail."  
16 Do you see that?  
17 A I do.  
18 Q Do you have an understanding as to what AR-15  
19 style firearm means in that sentence?  
20 A I think it shares the same silhouette, or a  
21 similar silhouette.  
22 Q And would you agree that the Daniel Defense  
23 DDM4 V7 is an AR-15 style firearm?  
24 A That's what the manufacturer says.  
25 Q The manufacturers, if they represent that



Page 117

1 something is an AR-15 style firearm, they generally know  
2 what they are talking about?  
3 MR. MAAG: Object to generalities.  
4 Q (By Mr. Wells) I'll withdraw the question.  
5 All right. I'm going to direct your attention  
6 to page five. Do you see where it says terrific weapon?  
7 A Yes.  
8 Q And in the first sentence under terrific  
9 weapon, it says, "After looking at many AR-style 5.56  
10 rifles, including Ruger, SIG, Savage and others, I settled  
11 on the DDM4 V7 mil-spec version."  
12 Do you see that?  
13 A I do.  
14 Q Do you have an understanding of what AR-style  
15 means in this sentence?  
16 A I believe I do.  
17 Q What is that understanding?  
18 A That it is similar in appearance to an AR.  
19 Q When you say similar in appearance, what do  
20 you mean?  
21 A Visually.  
22 Q Directing your attention to the last sentence.  
23 A Same paragraph?  
24 Q Same paragraph under terrific weapon. Do you  
25 see where it says, "I did not intend to spend this much

Page 118

1 money on an AR rifle, but this is a beautiful weapon that  
2 will provide me with many years of use and enjoyment."  
3 Do you see that?  
4 A I do.  
5 Q Do you have an understanding as to what AR  
6 rifle means in this sentence?  
7 A Yes.  
8 Q What is that understanding?  
9 A That the author believes it's an AR rifle.  
10 Q All right. I'm directing your attention to  
11 page six. So just flip one page. To the very bottom, do  
12 you see where it says, "My dream AR"?  
13 A Yes.  
14 Q Do you have an understanding as to what AR  
15 means there?  
16 A Yes.  
17 Q Do you understand AR there to refer to an AR  
18 rifle?  
19 A I'm assuming it means this particular rifle.  
20 Q Which is an AR-15 rifle; is that right?  
21 A It could be.  
22 Q Do you see in that same comment, page six at  
23 the bottom, "I don't have a lot to add to all the other  
24 five-star reviews. Without a doubt the best AR I have ever  
25 held or shot."

Page 119

1 Do you have an understanding as to what AR  
2 means in that sentence?  
3 A Yes.  
4 Q Have you ever shot an AR-15 rifle?  
5 A I don't think so.  
6 Q Have you ever held an AR-15 rifle?  
7 A I don't think so.  
8 MR. WELLS: Why don't we take a short break.  
9 THE VIDEOGRAPHER: This is the videographer.  
10 We are going off the record. Time now is 12:25.  
11 (Whereupon, a short break was taken.)  
12 THE VIDEOGRAPHER: This is the videographer.  
13 We are back on the record. Time now is 12:31.  
14 Q (By Mr. Wells) I'm going to mark another  
15 exhibit here. We are on to No. 9.  
16 A Nine.  
17 (Deposition Exhibit No. 9 marked for  
18 identification.)  
19 Q (By Mr. Wells) I'm showing you what I have  
20 marked as Deposition Exhibit 9, which I can represent to  
21 you is a printout from pewpewtactical.com. It's a  
22 screenshot. I would like to direct your attention to the  
23 second page. Do you see where it says "the modern AR-15"  
24 at the bottom of the page?  
25 A Yep.

Page 120

1 Q It says, "It used to be really easy, head down  
2 to your local gun shop and choose from the two or three ARs  
3 they had on the shelf. But those days are long gone. Now  
4 you're bombarded with too many choices."  
5 Do you see that?  
6 A Yes.  
7 Q What do you understand those sentences to  
8 mean?  
9 A They are marketing their inventory.  
10 Q Who is they?  
11 A Pew Pew Tactical.  
12 Q Do you have an understanding as to what head  
13 down to your local gun shop and choose from the two or  
14 three ARs they had on the shelf, do you have an  
15 understanding as to what two or three ARs means in that  
16 sentence?  
17 A I think this is referencing two or three  
18 manufacturers.  
19 Q Manufacturers of what?  
20 A Rifles.  
21 Q What kind of rifles?  
22 A What they are calling AR-type.  
23 Q Do you understand what they are saying in this  
24 sentence?  
25 A Yes. The market has exploded.

Page 121

1 Q The market for what has exploded?  
2 A The choices of AR-types.  
3 Q I would like to direct your attention back to  
4 paragraph 10 of your May 19th exhibit -- declaration.  
5 A Exhibit 1?  
6 Q Exhibit 1. Where you say, "In fact, even the  
7 list examples" -- and you're referring to PICA there; is  
8 that right?  
9 A Correct.  
10 Q "Are oftentimes not within the parameters of  
11 what even most firearms experts would consider to be an  
12 AK-type, like the SKS of an AR-type."  
13 A Yes.  
14 Q What do you mean by this sentence?  
15 A I don't remember my thinking from May.  
16 Q Do you wish to withdraw that testimony now?  
17 A Not at the moment.  
18 Q As you sit here right now, do you still  
19 believe that there are parameters of what even most  
20 firearms experts would consider to be an AK-type, like the  
21 SKS of an AR-type?  
22 (The requested portion of the  
23 record read by the reporter.)  
24 A Yes, I believe they have their opinion.  
25 Q Do you have an opinion as to what parameters

Page 122

1 there are for an AR-type?  
2 MR. MAAG: Objection. Asked and answered  
3 about 10 times earlier in the deposition.  
4 A Do you have another question?  
5 Q (By Mr. Wells) There's still a question  
6 pending. I can withdraw and move on.  
7 All right. Let's talk about AK-47s. What is  
8 an AK-47?  
9 A It was designed by Kalashnikov during World  
10 War II for -- when Kalashnikov interviewed many of his  
11 fellow soldiers, that he realized many of the wounded were  
12 wounded because their rifles were unreliable and he  
13 developed a rifle that would go through extreme conditions  
14 and still be functional.  
15 Q What does the AK stand for in AK-47?  
16 A I can't remember his first name. His last  
17 name is Kalashnikov. I think it's Anton [sic].  
18 Q So the K stands for Kalashnikov in AK?  
19 A I think so.  
20 Q And would you agree that the AK-47 is one of  
21 the most famous weapons in the world?  
22 A I guess a rifle can have fame. Dukes of  
23 Hazard did.  
24 Q Is that a yes?  
25 A Yes.

Page 123

1 Q And there have been many millions of AK-47s  
2 produced; correct?  
3 A I think so.  
4 Q I'm going to read you a statement and I want  
5 you to let me know if you agree with it.  
6 "After more than seven decades since its  
7 creation, the AK-47 model and its variants remain one of  
8 the most popular and widely used firearms in the world."  
9 Do you agree with that statement?  
10 A Yes.  
11 Q Do you own an AK-47?  
12 A No.  
13 Q Do you own any AK-type firearm?  
14 A No.  
15 Q Prior to PICA taking effect on January 10th,  
16 2023, did you intend to acquire an AK-type firearm?  
17 A I'd like to have one, yes.  
18 Q So right now you'd like to acquire an AK-type  
19 firearm; is that right?  
20 A Yes.  
21 Q Prior to PICA taking effect on January 10th,  
22 2023, did you have any plans to purchase an AK-type  
23 firearm?  
24 A If I found a deal, I would have bought it.  
25 Q Did you ever do that?

Page 124

1 A No.  
2 Q What's changed between when PICA took effect  
3 and now that has made you want to get an AK-type firearm?  
4 I'm sorry. Prior to -- Let me rephrase that. What has  
5 changed from prior to January 10th, 2023, and now, so  
6 subsequent to January 10th, 2023, to the present, that's  
7 made you want to acquire an AK-type firearm?  
8 A Personal choice.  
9 Q What do you mean by personal choice?  
10 A Well, I don't plan in advance to have  
11 McDonald's, so when I choose to have McDonald's, I have  
12 McDonald's.  
13 Q But since PICA has taken effect on  
14 January 10th, 2023, it's since then that you have developed  
15 a desire to acquire an AK-type firearm; is that fair?  
16 A Yeah. That's fair.  
17 Q Are you familiar with what an AK-74 firearm  
18 is?  
19 A I think so.  
20 Q Are you familiar with what an AK-56 firearm  
21 is?  
22 A I'm not sure.  
23 Q Are you familiar with what a type 56 rifle is?  
24 A I'm not sure.  
25 Q So we're going to go back to the statute. I



Page 125

1 think it's Exhibit 7., and I'm directing your attention to  
2 page two. So we were looking at subsection J, little Roman  
3 two. Now we're going to be looking at J, little Roman one,  
4 where it says all AK-types. Do you see that?  
5 A I do.  
6 Q And you said earlier that you were familiar  
7 with this statute even before it was signed; is that right?  
8 A Correct.  
9 Q I want you to review the list of firearms  
10 listed under all AK-types, so it's Roman one through six,  
11 and Roman one has several different numbers. I want you to  
12 review one through six and tell me which firearms in there  
13 you don't believe were properly categorized as an AK-type.  
14 A Roman numeral six.  
15 Q Any others?  
16 A I don't think so.  
17 Q So Roman numeral six is the SKS with the  
18 detachable magazine; is that right?  
19 A Right.  
20 Q Why do you think that the SKS is not an AK  
21 type?  
22 A Because they share no parts.  
23 Q Are there any other reasons?  
24 A If I remember right, the SKS came with a  
25 10-round fixed magazine. So the detachable mag is an

Page 126

1 aftermarket thing.  
2 Q Any other reasons?  
3 A A couple of the YouTube videos that I watched  
4 said that when the SKS was converted, many of them  
5 didn't -- or converted to the magazine type, many of them  
6 didn't cycle properly.  
7 Q Do you remember what those YouTube videos were  
8 called?  
9 A Something like the difference between AK and  
10 SKS.  
11 Q When did you review those videos on YouTube?  
12 A Oh, May through present.  
13 Q May through present?  
14 A Yeah.  
15 Q Did you review those videos on YouTube prior  
16 to preparing your May 19th, 2023, declaration in this case?  
17 A I think so. Yeah. I think I -- Yeah, then  
18 that would be April then. That would be just after the  
19 tornado hit. So that would be April through present.  
20 Q Have you ever owned an SKS firearm?  
21 A No.  
22 Q Prior to January 10th, 2023, did you have any  
23 plans to purchase an SKS firearm?  
24 A I considered buying one.  
25 Q When did you consider that?

Page 127

1 A Maybe four years ago.  
2 Q But four years ago you didn't actually follow  
3 through and purchase the SKS at that time?  
4 A No, it was defective.  
5 Q Do you know what caliber the SKS uses?  
6 A 7.62.  
7 Q Is that the same caliber as an AK-47?  
8 A Yes.  
9 Q What's the country of origin for an SKS?  
10 A I think Russia and then there's -- I think  
11 there's a bunch of Chinese knockoffs, too.  
12 Q But in terms of the original SKS --  
13 A Originally, I think Russia.  
14 Q Let me say --  
15 A My bad.  
16 Q The original SKS rifle you would agree was  
17 designed by a Russian; is that right?  
18 A I believe so.  
19 Q And the AK-47 was also designed by a Russian  
20 originally?  
21 A Correct.  
22 Q So the SKS shares a common caliber with the  
23 AK-47 and originated from the same country as the AK-47;  
24 fair enough?  
25 A Yes.

Page 128

1 Q Are you familiar with Palmetto State Armory?  
2 A Yes.  
3 Q What do you think of Palmetto State Armory as  
4 a manufacturer?  
5 A I think their prices are reasonable.  
6 Q Do you own any firearms made by Palmetto State  
7 Armory?  
8 A I don't think so.  
9 Q Have you ever thought about buying any  
10 firearms manufactured by Palmetto State Armory?  
11 A I don't think so.  
12 Q Have you ever looked at the Palmetto State  
13 Armory website?  
14 A I think so.  
15 Q Ten?  
16 (Deposition Exhibit No. 10 marked for  
17 identification.)  
18 Q (By Mr. Wells) So I'm marking Deposition  
19 Exhibit 10. No sticker, Tom, I'm sorry.  
20 So I have shown you what I have marked as  
21 Deposition Exhibit 10, which I can represent to you are  
22 screenshots of the Palmetto State Armory Website,  
23 palmettostatearmory.com. Do you see on the first page here  
24 across the top, the black banner with the white script?  
25 A I do.

Page 129

1 Q Do you see where it says AR-15, AR-10 and  
2 AK-47?  
3 A Yes.  
4 Q Do you have an understanding as to what those  
5 terms mean?  
6 A Yes.  
7 Q And you understand what AK-47 in particular  
8 means here; is that correct?  
9 A I think you're referring to the rifle.  
10 Q The rifle that shares common design elements  
11 with the original AK-47 designed by Kalashnikov; is that  
12 right?  
13 A Yes.  
14 Q And if you look at the top here, you don't see  
15 any reference to SKS, do you?  
16 A I do not.  
17 Q Do you know if the SKS is still being  
18 manufactured for sale in the U.S.?  
19 A I do not.  
20 Q Would you agree that the SKS is not nearly as  
21 common in the U.S. as the AK-47; is that correct?  
22 A Yes.  
23 Q So I'm directing your attention to the third  
24 page here. You got to count.  
25 MR. MAAG: I can do that.

Page 130

1 Q (By Mr. Wells) Directing your attention to the  
2 middle of the page underneath where it says AK-47 rifles,  
3 pistols, parts and much more.  
4 A Yes.  
5 Q Underneath there it says, "Palmetto State  
6 Armory is your online AK-47 headquarters. Whether you are  
7 looking for a complete AK-47 rifle/pistol or AK parts, we  
8 have it all and from the top brands you know and trust."  
9 Do you have an understanding as to what AK  
10 parts means there?  
11 A Yes.  
12 Q And is it fair to say the reference to AK  
13 parts is a reference to AK-47 parts?  
14 A In the advertisement, yes.  
15 Q Okay. Turning to the next page, AK-P. Do you  
16 see that?  
17 A Yes.  
18 Q Do you have an understanding as to what AK-P  
19 means as depicted here?  
20 A My guess is Palmetto manufactured AK parts.  
21 Q I'm going to direct your attention to the  
22 couple of sentences right underneath there. It says,  
23 "Feast your eyes on Palmetto State Armory's AK-P, the new  
24 standard in AK-47 pistols."  
25 Do you see that?

Page 131

1 A Yes.  
2 Q So having read that, do you understand AK-P to  
3 mean AK pistol?  
4 A Yes.  
5 Q And an AK pistol is a pistol version of an  
6 AK-47; right?  
7 A Right.  
8 Q You can put that one away. Eleven?  
9 A Correct.  
10 (Deposition Exhibit No. 11 marked for  
11 identification.)  
12 Q (By Mr. Wells) I'm showing you what I have  
13 marked as Deposition 11 -- Exhibit 11, which I can  
14 represent to you is a PDF of website information from  
15 Palmetto State Armory. You can see the URL at the bottom,  
16 Palmettostatearmory.com/psak-47, and then it goes on.  
17 Directing your attention to the first page  
18 where it says PS AK-47 and then it's got a picture of a  
19 firearm below that. Do you see that?  
20 A I see.  
21 Q Would you agree that this rifle that's  
22 depicted on page one of Deposition 11, Deposition  
23 Exhibit 11, is an AK-type firearm?  
24 A Yeah.  
25 Q What are you basing that answer on?

Page 132

1 A That's how they are advertising it.  
2 Q Any other reasons besides how they are  
3 advertising it that you think this is an AK-type firearm?  
4 A I'm kind of surprised to see somebody selling  
5 a forged, but it's not an original forged, but the  
6 silhouette looks the same.  
7 Q Anything else about it that makes you think  
8 it's an AK-type firearm?  
9 A No.  
10 Q Directing your attention to page two, under  
11 product details, towards the bottom. Do you see where it  
12 says 7.62 by 39 caliber?  
13 A I do.  
14 Q That's the AK-47 caliber; right?  
15 A Traditionally.  
16 Q So is the caliber another aspect of this rifle  
17 that you think would put it in the AK-47 category?  
18 A I think so.  
19 Q I'm directing your attention to page three.  
20 Bottom of the page -- or bottom of the written part of the  
21 page. It says, "As we are transitioning to Soviet Arms,  
22 your receivers may be stamped with our new AK Soviet Arms  
23 logo on firearms manufactured after March 8th, 2023. This  
24 will not affect the quality or function of the firearm, as  
25 they are the same AK receivers used for our AKs."

Page 133

1 Do you see that?  
2 A Yes.  
3 Q Do you understand what AK means in this  
4 sentence?  
5 A Yes.  
6 Q All right. I'm directing your attention to  
7 page seven. And again, we're on Exhibit 11. Do you see  
8 the comment, another PSA winner, in the middle of the page?  
9 A I do.  
10 Q And under that it says, "My first AK and it is  
11 a beauty."  
12 Do you see that?  
13 A I do.  
14 Q Do you have an understanding as to what AK  
15 means?  
16 A Yes.  
17 Q What is that understanding?  
18 A It's the model of the rifle that he's proud  
19 of.  
20 Q And what is that model?  
21 A AK-47.  
22 MR. WELLS: Just take a short break.  
23 THE VIDEOGRAPHER: This is the videographer.  
24 We are going off the record. Time now is 12:57.  
25 (Whereupon, a short break was taken.)

Page 134

1 THE VIDEOGRAPHER: This is the videographer.  
2 We are back on the record. Time now is 12:59.  
3 Q (By Mr. Wells) So I'm going to direct your  
4 attention back to Exhibit 2. So this is your June 27th  
5 affidavit. The very last two pages.  
6 MR. MAAG: Number two?  
7 MR. WELLS: Yeah.  
8 MR. MAAG: And which page?  
9 MR. WELLS: The last very two. So 42 and 43,  
10 according to the ECF stamp.  
11 MR. MAAG: Right.  
12 A Yeah. I found it. I just had to get to the  
13 bottom of the pile. What page?  
14 Q (By Mr. Wells) 42 and 43.  
15 A 42, 43. Yeah. Those are cool.  
16 Q So we're looking at Deposition Exhibit 11,  
17 pages 42 and 43. You said those are cool. What do you  
18 mean?  
19 (Interruption during the depo.)  
20 Q (By Mr. Wells) All right. So let me go back.  
21 Can you read back my last question?  
22 (The requested portion of the  
23 record read by the reporter.)  
24 A John Browning revolutionized the gun industry  
25 with the BMG. These are -- I think these should be

Page 135

1 considered national treasurers.  
2 Q And you're referring to the firearms depicted  
3 on 42 and 43?  
4 A One on page 42. Yes, and 43.  
5 Q Do you own these firearms?  
6 A I wish.  
7 Q So that's a no?  
8 A Correct.  
9 Q Prior to January 10th, 2023, did you ever have  
10 any plans to acquire these firearms?  
11 A If I won the lottery, yeah.  
12 Q Why do you say if you won the lottery?  
13 A Oh, man. I'm not sure I can legally own them  
14 in Illinois, but I know I can own them in Indiana.  
15 Q Are they expensive?  
16 A I think so.  
17 Q Do you have any idea how much the firearms  
18 depicted on pages 42 and 43 of Deposition Exhibit 11 cost  
19 today?  
20 A No.  
21 Q But your sense is that it's a lot of money?  
22 A That's historical, so, yeah.  
23 Q When you say that's historical, what do you  
24 mean?  
25 A That's a hundred years old.

Page 136

1 Q Is it still in production?  
2 A Oh, no.  
3 Q So the firearm depicted at page 42 of  
4 Deposition Exhibit 11 is no longer in production, as far as  
5 you know?  
6 A As far as I know, it's not in production any  
7 longer.  
8 Q And it's in fact over a hundred years old, is  
9 that what I heard?  
10 A Uh-huh (yes).  
11 Q Is that a yes?  
12 A Correct.  
13 Q And flipping to page -- and, I'm sorry, what  
14 was the name of this firearm again?  
15 A The Browning BMG.  
16 Q And what does BMG stand for?  
17 A Browning Machine Gun.  
18 Q Is that a reference to a World War I era  
19 machine gun?  
20 A No, I think it's a reference from then to  
21 date.  
22 Q Okay. But Browning was somebody who lived in  
23 the early 20th century; right?  
24 A Yes.  
25 Q Or the company Browning made this rifle in the

Page 137

1 early 20th century; is that right?  
2 A Yeah. But I think he was born in the 19th  
3 century, so 1800s, but ...  
4 Q And as far as you understand, the firearm  
5 depicted at page 42 of Deposition Exhibit 11, it's not  
6 legal under Illinois law; is that right?  
7 A I don't think it is.  
8 Q Do you know if it's legal to own under federal  
9 law?  
10 A I think it is.  
11 Q But you have never tried to follow through and  
12 purchase one; is that right?  
13 A Correct.  
14 Q Looking at -- Is it a fully automatic weapon,  
15 the weapon on page 42 of Deposition Exhibit 11?  
16 A Yes.  
17 Q Is it a machine gun?  
18 A Yes, that's what the M stands for.  
19 Q Looking at page 43 of Deposition Exhibit 2.  
20 Are these firearms also machine guns?  
21 A Yes.  
22 Q They are also fully automatic?  
23 A Yes.  
24 Q Have you ever tried to buy any of the firearms  
25 depicted on page 43 of Deposition Exhibit 2?

Page 138

1 A No.  
2 Q Why not?  
3 A One, I can't afford them. Two, I don't want  
4 to put up with the maintenance of a water-cooled machine.  
5 Q Have you ever personally fired an AK-47?  
6 A I don't think so.  
7 Q Have you ever fired an AK-type firearm of any  
8 kind?  
9 A I don't think so.  
10 Q Have you ever personally fired an AK pistol?  
11 A Yeah, that's a definite no. I'd remember  
12 that. Those are ugly.  
13 Q When you say ugly, what do you mean?  
14 A They don't look symmetrical in my mind.  
15 Q The AK pistol does not?  
16 A Yeah. It just doesn't look like it has  
17 balance.  
18 Q Is that because the caliber and the pistol  
19 itself are --  
20 A Just my eye.  
21 Q Just your eye?  
22 A Yeah.  
23 Q Just looks uneven?  
24 A It just looks wrong.  
25 Q Okay.

Page 139

1 MR. MAAG: No feng shui?  
2 THE WITNESS: Yeah. That's about right.  
3 MR. WELLS: With my reservation of rights at  
4 the beginning that obviously we're just here on a  
5 deposition on your motion for summary judgment on the two  
6 vagueness claims and recognizing that the case may come  
7 back from the Seventh Circuit on the Second Amendment  
8 claims at which time we may seek additional discovery,  
9 including written discovery and possibly a second  
10 deposition of Mr. Wilson, I have no further questions at  
11 this time.  
12 MR. MAAG: I do have some questions, and from  
13 a mechanical standpoint, it may be a lot faster if you and  
14 I change spots, if that would be agreeable.  
15 MR. WELLS: Okay. And let me just clarify.  
16 So at the beginning of the deposition, before the  
17 deposition started, Mr. Maag and Mr. Wilson brought in  
18 several boxes of objects that I don't know what they are,  
19 but I assume we're about to find out. Is that fair enough?  
20 MR. MAAG: That's a fair statement.  
21 MR. WELLS: And these are items that have not  
22 been produced or that I haven't been allowed to inspect  
23 them in the course of this litigation; is that fair to say?  
24 MR. MAAG: I invited you and your other  
25 associates over on multiple occasions.

Page 140

1 MR. WELLS: And did you identify any of these  
2 items in the discovery, in response to the written  
3 discovery that we served?  
4 MR. MAAG: That's due tomorrow, no.  
5 MR. WELLS: I just note for the record that I  
6 object to the use of whatever is in these boxes. I'd note  
7 that, Mr. Maag, you chose to file a motion for summary  
8 judgment without having conducted discovery, no party had  
9 conducted discovery, and these are now being brought in  
10 potentially in some fashion to supplement your motion for  
11 summary judgment and I would object to that. I will note  
12 it for the record.  
13 MR. MAAG: Your objection is so noted for the  
14 record.  
15 THE VIDEOGRAPHER: This is the videographer.  
16 We are going off the record. Time now is 1:07.  
17 (Whereupon, a short break was taken.)  
18 THE VIDEOGRAPHER: This is the videographer.  
19 We are back on the record. Time now is 1:08.  
20 EXAMINATION  
21 QUESTIONS BY MR. MAAG:  
22 Q And you're still under oath, Mr. Wilson.  
23 There was a discussion of magazines. I'm handing you  
24 various magazines.  
25 MR. WELLS: I'm going to just note my

Page 141

1 objection for the record that these are items that I have  
2 never seen prior to right now and that haven't been  
3 identified in any discovery.  
4 Q (By Mr. Maag) And as I noted, you and your  
5 predecessors have been invited many times. Do you  
6 recognize those, generally speaking, as firearm magazines?  
7 A I do.  
8 Q All right. And is it fair to say there are  
9 various designs?  
10 A Easily.  
11 Q All right. Do you recognize one of those as a  
12 Glock-type magazine?  
13 A Yes.  
14 Q Which one is that?  
15 A It would be this one with Glock on the bottom.  
16 Q All right. Is that a pistol magazine, rifle  
17 magazine, shotgun magazine or something different, or do  
18 you know?  
19 A I don't know.  
20 MR. WELLS: Objection to the form. Compound  
21 question.  
22 Q (By Mr. Maag) All right. Why is it that you  
23 don't know?  
24 A Because I can't tell by looking.  
25 Q Is that magazine potentially compatible with a

Page 142

1 pistol?  
2 A I would assume it is.  
3 Q All right. Is that magazine potentially  
4 compatible with a rifle?  
5 A It could be.  
6 Q Okay. I'm handing you a different magazine.  
7 Do you recognize that magazine?  
8 A No.  
9 Q If I were to represent to you that that is a  
10 magazine for a U.S. M1 carbine, would you recognize that  
11 model of firearm?  
12 A I think so.  
13 Q Is that a rifle or a pistol?  
14 A M1 carbine is a rifle.  
15 Q All right. Are you aware of whether or not a  
16 pistol version of the M1 carbine is manufactured?  
17 A I think so.  
18 Q And assuming that that magazine held 15  
19 rounds, would that magazine be legal as you understand it  
20 for sale or trade in Illinois under PICA for pistols?  
21 MR. WELLS: Objection. Legal conclusion.  
22 Q (By Mr. Maag) You can answer.  
23 (The requested portion of the  
24 record read by the reporter.)  
25 A Yes.

Page 143

1 Q Assuming that magazine held 15 rounds, as you  
2 understand PICA, would that magazine be legal for sale,  
3 trade or non-grandfathered possession for a rifle?  
4 MR. WELLS: Objection. Form.  
5 Q (By Mr. Maag) You can answer.  
6 A I don't believe so.  
7 Q Is there any objective way to determine  
8 whether that magazine is for a rifle or a pistol?  
9 MR. WELLS: Objection to the form. Vague.  
10 Q (By Mr. Maag) You can answer.  
11 A I don't see how you can tell a difference.  
12 Q Okay. I'm handing you another magazine. Are  
13 there any markings on that magazine?  
14 A No.  
15 Q Are you able to discern whether that magazine  
16 is for a rifle, pistol, shotgun or other?  
17 A A rifle or a pistol. I don't see a shotgun  
18 shell fitting in that.  
19 Q All right. So it's your testimony that could  
20 fit either potentially a rifle or a pistol; is that  
21 accurate?  
22 A Yes.  
23 Q All right. Is there any way, as you hold that  
24 magazine in your hand today, that you can discern whether  
25 that is a rifle or a pistol magazine?

Page 144

1 A No.  
2 Q Handing you the next magazine. Are there any  
3 markings on that one?  
4 A No.  
5 Q Are you able to determine whether --  
6 A I'm wrong. There is a serial number here.  
7 Q What is the serial number?  
8 A Or model number.  
9 Q Whatever the number is.  
10 A Alpha 15981.  
11 Q Okay. As you look at that today, are you able  
12 to discern whether that is a magazine for a rifle, pistol,  
13 shotgun or other?  
14 A No.  
15 Q As you hold that today, are you able to see  
16 any way you could objectively discern whether that fits a  
17 rifle, pistol, shotgun or other?  
18 A No.  
19 MR. WELLS: Objection. Form. Go ahead.  
20 Q (By Mr. Maag) All right. I'm handing you  
21 another magazine. Are there any markings on that one?  
22 A No.  
23 Q Are you able to discern from looking at that  
24 magazine whether that magazine is for a rifle, pistol,  
25 shotgun or other?



Page 145

1 A No.

2 Q Handing you another magazine. Are you able to

3 discern whether that magazine is for a rifle, pistol,

4 shotgun or other?

5 A No.

6 Q Are there any markings on that magazine?

7 A No.

8 Q I'm handing you another magazine. Are there

9 any markings on that magazine?

10 A Yes.

11 Q And generally what are they?

12 A FN Manufacturing, Columbia, South Carolina.

13 Q All right. Do you recognize that magazine?

14 Not that particular one, but that kind of magazine?

15 A No.

16 Q Okay. Do you know whether that magazine would

17 fit in a rifle, pistol, shotgun or other?

18 A No.

19 Q All right. Are there any markings on that

20 magazine?

21 A Yes.

22 Q What are the markings?

23 A 35\_Alpha.

24 Q Are you able to discern whether that magazine

25 is for a rifle, pistol, shotgun or other?

Page 146

1 A No.

2 Q Handing you another magazine. Are there any

3 markings on that magazine?

4 A No.

5 Q Perhaps on the bottom side?

6 A Oh, there it is. Walther P1 9-millimeter.

7 Q Are you able to discern whether that is for a

8 rifle, pistol, shotgun or other?

9 A No.

10 Q I'll hand you another magazine. Are there any

11 markings on that?

12 A Yes. Colyer clip.

13 Q Any other markings?

14 A M88, M100, .308 caliber, .243 caliber.

15 Q Are you able to discern whether that magazine

16 is for a rifle, pistol, shotgun or other?

17 A No.

18 Q I'm handing you -- Are there any markings on

19 that magazine?

20 A Made in China. That's all I see.

21 Q Are you able to discern whether that magazine

22 is for a rifle, pistol, shotgun or other?

23 A I think this is from the SKS comparison video.

24 Q Okay. Is that simply because you recognize it

25 or is there something about it marking-wise?

Page 147

1 A I recognized it from the video.

2 Q All right. Beyond that, are you able to

3 discern whether that's for a rifle, pistol, shotgun or

4 other, other than the fact that you recognize that it may

5 be from an SKS?

6 A I'm going to guess rifle.

7 Q Okay. Is that a guess?

8 A That's a guess.

9 Q All right.

10 MR. WELLS: Tom, just to be clear, you don't

11 have any fully assembled firearms?

12 MR. MAAG: No.

13 A Correct.

14 MR. MAAG: There is nothing here that could

15 potentially go bang.

16 MR. WELLS: Understood.

17 Q (By Mr. Maag) I'm handing you a magazine. Do

18 you recognize what that is for?

19 A With everything in front of me, I think it's

20 for a 1911.

21 Q All right. Is that a rifle, pistol, shotgun

22 or other magazine?

23 A I think it's all of the above.

24 Q All right. Do you recognize what that is,

25 generally?

Page 148

1 A That's the frame of a 1911.

2 Q And what is a 1911? A rifle, pistol, shotgun?

3 A Pistol. Pistol.

4 Q All right. Can you put the magazine in?

5 A I can.

6 Q And of course it's missing parts so it won't

7 stay in, but for demonstrative purposes, does that magazine

8 fit?

9 A Yeah.

10 Q All right.

11 A It looks like it would cycle.

12 Q And I'm handing you a wooden stock. Can you

13 attach that? Until it snaps. And by attaching that, does

14 that become a rifle, assuming it was assembled with a

15 barrel?

16 A I think it is.

17 Q And would that be the same magazine both ways?

18 A Yes, it's the same frame.

19 Q Thank you. You were asked about AR-type

20 firearms.

21 MR. WELLS: I just note again my objection for

22 the records. These are items that have --

23 MR. MAAG: As far as I'm concerned, you have a

24 standing objection.

25 MR. WELLS: I may still note it, but

Page 149

1 understood.  
2 Q (By Mr. Maag) I'm handing you various items.  
3 Do you recognize generally what those are?  
4 A Yes.  
5 Q Generally what are they?  
6 A Frames for rifles.  
7 Q All right. Are they necessarily for rifles or  
8 can they also potentially be assembled as pistols?  
9 A They could be assembled as pistols as well.  
10 Q All right. And I'm going to hand you one.  
11 Can you read the marking on that to identify it?  
12 A Yes. Palmetto State Armory.  
13 Q Is there a model number?  
14 A I don't know. I don't know if it's G3-10.  
15 Q Do you see anything else that might be a model  
16 number?  
17 A And then multi on it and then "golf" 381517.  
18 Q All right. I'll hand you what has been marked  
19 as Deposition Exhibit 7. Under AR-type, do you see that  
20 model number listed as an AR-type firearm?  
21 A I don't see anything for Palmetto Armory.  
22 Q Just make sure that's right. All right. Do  
23 you see anything on that frame that identifies it as an  
24 AR-10, AR-15 or AR-type?  
25 A No.

Page 150

1 Q Do you know if that is an AR-10, AR-15 or  
2 AR-type?  
3 A No.  
4 Q Thank you. I'm going to hand you another  
5 receiver. Does it have a make and model on it?  
6 A I don't know if Maadi EE is it.  
7 Q Probably -- Yeah. That's correct. Go ahead.  
8 A Maadi EE, caliber .308.  
9 Q All right. Is that particular firearm listed  
10 as an AR-type or anywhere else on this list of Exhibit 7?  
11 A No.  
12 Q Is there anything on there that would indicate  
13 that that is an AR-10, AR-15 or AR-type, generally?  
14 A I don't see anything on it.  
15 Q I'll hand you the next item. Does that have a  
16 model number?  
17 A Model TGM-9.  
18 Q Has that got a manufacturer on it?  
19 A Yes.  
20 Q What's the manufacturer?  
21 A Benbow City Sports.  
22 Q Is that listed anywhere by name on the assault  
23 weapons ban?  
24 A No, it's not listed in the Bs.  
25 Q All right.

Page 151

1 MR. WELLS: Just for the record, Mr. Maag,  
2 Benbow City Sports, that's your business; is that right?  
3 MR. MAAG: I do own Benbow City Sports, that's  
4 correct.  
5 Q (By Mr. Maag) Will you hold onto that? Do you  
6 still have that Glock magazine? Does the Glock magazine  
7 fit that?  
8 A It does. It locks into it.  
9 Q All right. I'll hand you another receiver.  
10 Is there a make and model on that?  
11 A Model M4E1.  
12 Q And is there a brand name?  
13 A Aero Precision.  
14 Q Is there anything marked on that or otherwise  
15 that would indicate that that's an AR-type, an AR-10 or an  
16 AR-15?  
17 A Not that I see.  
18 Q All right. Do you see that receiver listed  
19 anywhere on the banned list?  
20 MR. WELLS: Objection. Form.  
21 A I don't see it in the As or the Ms.  
22 Q (By Mr. Maag) All right. Do you know whether  
23 or not those particular receivers are AR-15s or AR-10s or  
24 AR-types?  
25 A No.

Page 152

1 Q No, you don't know, or, no, they are not?  
2 A I do not know.  
3 Q All right. Do you know if any of the parts  
4 that are compatible with one of them are compatible with  
5 another one of them?  
6 A Are you asking me between what's on the table  
7 here, if they are interchangeable?  
8 Q Yeah. Or do you believe any parts from which  
9 you're looking at are potentially -- are any of the major  
10 parts interchangeable?  
11 MR. WELLS: Objection. Form. Vague.  
12 Q (By Mr. Maag) I'll rephrase.  
13 A I do not know.  
14 Q We have an upper receiver for one of these  
15 firearms that will fit on the Benbow City Sports lower  
16 receiver; correct?  
17 A Correct.  
18 Q Will that fit on the Palmetto State Armory  
19 lower receiver? And if you want to remove the tag, feel  
20 free, if you think that's going to matter.  
21 A Yeah. It fits. No, it does not. It does not  
22 make up.  
23 Q So there's a difference between the two lower  
24 receivers that are larger?  
25 A Correct.

Page 153

1 Q You were asked about the AK-47. Do you  
2 recognize that part?  
3 A I think this is the gas piston and bolt.  
4 Q All right. Are you familiar with the M1  
5 Garand?  
6 A A little bit.  
7 Q Substantively, is there any difference that  
8 you're aware of, other than the size, between the gas  
9 piston and bolt on the AK-47 and the M1 Garand?  
10 MR. WELLS: Objection. Form.  
11 (The requested portion of the  
12 record read by the reporter.)  
13 Q (By Mr. Maag) Garand, G-A-R-A-N-D.  
14 A I don't think that there is. I think they  
15 are -- what Russians do best, copy everybody else's stuff  
16 and integrate it.  
17 Q Okay. The M1 Garand, that would have been  
18 developed before World War II?  
19 A I think so.  
20 Q And I think that you were asked about when the  
21 AK-47 was designed.  
22 A Yes, World War II.  
23 Q So the Garand came first?  
24 A Yes.  
25 Q Based on your reading of this ban list, do you

Page 154

1 know whether or not the M1 Garand is a copy, duplicate,  
2 variant or altered facsimile with the capability of an  
3 AK-type rifle?  
4 (The requested portion of the  
5 record read by the reporter.)  
6 A I don't think so.  
7 Q (By Mr. Maag) But do you know?  
8 A I do not know.  
9 Q You were asked about AR-types on the banned  
10 list, do you remember that?  
11 A I do.  
12 Q Are you familiar with the Bushmaster ACR?  
13 A No.  
14 Q Are you familiar with the Beretta AR-70?  
15 A I can't remember.  
16 Q All right. Are you familiar with all of the  
17 firearms listed on the banned list?  
18 A Oh, no.  
19 Q Does the ban make reference to prohibiting a  
20 semi-automatic rifle that has the capacity to have a pistol  
21 grip?  
22 A Yes.  
23 Q I'm handing you a wooden stock. What kind of  
24 stock is that commonly called, what you're holding on to?  
25 A Pistol grip.

Page 155

1 Q If I were to represent to you that that stock  
2 is for a U.S. carbine caliber .30 M1, would you have any  
3 reason to dispute me?  
4 A No.  
5 Q Assuming that a semi-automatic rifle that has  
6 the capacity to accept a detachable magazine and has a  
7 pistol grip stock is prohibited under the ban, and assuming  
8 that an M1 carbine is a semi-automatic rifle that has the  
9 capacity to accept a detachable magazine, and assuming that  
10 that is a factory M1 carbine stock, do you believe that the  
11 M1 carbine would be banned under a plain reading of this  
12 statute?  
13 MR. WELLS: Objection to form. Compound.  
14 Calls for a legal conclusion.  
15 Q (By Mr. Maag) You can answer.  
16 A The pistol grip, yes.  
17 Q Does that stock also have a shroud that  
18 partially or completely encircles the bearer, allowing the  
19 bearer to hold the firearm with a non-trigger hand without  
20 being burned?  
21 A It does.  
22 Q Is there anything about that stock that is  
23 novel or different from any traditional stock that has been  
24 on the market in the United States well over a hundred  
25 years?

Page 156

1 MR. WELLS: Objection to form.  
2 A I don't think so that.  
3 MR. MAAG: Nothing further.  
4 MR. WELLS: Can we switch again real quick?  
5 MR. MAAG: Sure.  
6 EXAMINATION  
7 QUESTIONS BY MR. WELLS:  
8 Q So, Mr. Wilson, Mr. Maag has just put various  
9 items in front of you, including some magazines and some  
10 receivers, and he's asked you questions about those; is  
11 that right?  
12 A Correct.  
13 Q Are any of these items on this table yours?  
14 A No.  
15 Q You were shown various magazines, including a  
16 Glock magazine. Are you able to identify the Glock  
17 magazine?  
18 A If you wish, you may take it.  
19 Q And you're handing it to me now; is that  
20 right?  
21 A Assuming you would like to look at it.  
22 Q And you were able to identify on the Glock  
23 magazine that it's manufactured by Glock; is that right?  
24 A Yes, it's stamped on there.  
25 Q And do you own any Glock firearms?

Page 157

1 A I do not.  
2 Q Okay. But you do own a Beretta M-92; is that  
3 right?  
4 A Right.  
5 Q And before you used a magazine in the Beretta  
6 M-92, you would be sure to know that that magazine held  
7 9-millimeter caliber ammunition; right?  
8 A Yes.  
9 Q And for any firearm that you used, you would  
10 make sure that the magazine that you're using held the  
11 right caliber of ammunition for that firearm; is that  
12 right?  
13 A Yes.  
14 Q And for some of these magazines that you  
15 looked at, there was no marking about caliber on them; is  
16 that correct?  
17 A Some of them, yes.  
18 Q Would you ever purchase a magazine for a  
19 firearm without knowing what caliber the magazine was for?  
20 A I think I have in the past.  
21 Q When?  
22 A Oh, man. 2006, maybe.  
23 Q Have you ever used ammunition in a firearm  
24 where you weren't sure whether the ammunition was the right  
25 caliber for the firearm?

Page 158

1 A No.  
2 Q Turning back to this Glock magazine. Do you  
3 see how it's got markings that say four, five, six, seven,  
4 eight, nine, 10, 11, 12, 13, 14, 15 on that?  
5 A I see that.  
6 Q And do you understand that this indicates how  
7 many rounds can actually fit in this magazine?  
8 A Or how many left.  
9 Q Right. But --  
10 A Yes.  
11 Q If you load it fully to 15, you understand  
12 that this particular magazine can hold 15 rounds; is that  
13 right?  
14 A Correct.  
15 Q Do you own an M1 carbine?  
16 A No.  
17 Q Have you ever owned an M1 carbine?  
18 A No, I've tried.  
19 Q You mentioned earlier when you were shown the  
20 1911 frame and you were asked to insert a magazine into  
21 it -- Can you find that magazine?  
22 A There it is.  
23 Q Okay. So you were able to look at the  
24 magazines on the table here and figure out which one would  
25 fit into the 1911; is that right?

Page 159

1 A Yes.  
2 Q Do you know whether that particular magazine  
3 with it inserted into that firearm and the firearm fully  
4 assembled, whether it would actually fire as you sit here  
5 today?  
6 A I believe it would.  
7 Q Well, you would have to test it, though;  
8 right?  
9 A Correct.  
10 Q And you haven't tested this magazine with this  
11 particular frame for a 1911; is that right?  
12 A I have not.  
13 Q So is it fair to say you were speculating as  
14 to whether or not this magazine would work in this 1911  
15 frame when fully assembled?  
16 (The requested portion of the  
17 record read by the reporter.)  
18 A No, I believe it will work.  
19 Q But you're just speculating?  
20 MR. MAAG: Objection. Asked and answered. If  
21 you really want, give me 30 minutes, I'll put it together  
22 and we can test it out back.  
23 MR. WELLS: Counsel, you're not testifying.  
24 MR. MAAG: Object.  
25 Q (By Mr. Wells) You mentioned a Colyer clip

Page 160

1 earlier; is that right?  
2 A Yes.  
3 MR. MAAG: It's the shinier one.  
4 A This one, there.  
5 Q (By Mr. Wells) So when I said Colyer clip,  
6 with Mr. Maag's assistance you were able to identify which  
7 magazine that was?  
8 A After I could read it, yeah.  
9 Q And on that particular magazine, the caliber  
10 was marked; is that right?  
11 A You're right. It was.  
12 Q When you attached the 1911 to the buttstock  
13 and Mr. Maag asked you whether that's a rifle, now, why did  
14 you say that it's a rifle?  
15 A Because it has a stock affixed to it.  
16 Q Why does that make it a rifle?  
17 A I believe the ATF defines it that way.  
18 Q So you're familiar with the ATF regulations?  
19 A Not all of them.  
20 Q But at least some of them?  
21 A Yes, a few.  
22 Q So you recognize under ATF regulations that  
23 this would be a short-barreled rifle; is that right?  
24 A Yes.  
25 Q And that would be regulated under federal law

Page 161

1 in a specific way; is that fair to say?  
2 MR. MAAG: Objection. It would depend on the  
3 length of the barrel.  
4 Q (By Mr. Wells) Do you agree with that?  
5 A Yes, sorry. I'm imagining it and it messes  
6 with my head. Yeah. He's right. The length of the  
7 barrel. I didn't consider that. But, yeah, it's a  
8 short-barreled rifle.  
9 Q So without having the barrel inserted, you  
10 can't tell today whether it's a short-barreled rifle under  
11 ATF regulations?  
12 A Oh, it is, because I've seen all the parts.  
13 Q You have seen all the parts?  
14 A Yeah.  
15 Q When did you see them?  
16 MR. MAAG: We can stipulate it's a registered  
17 short-barreled rifle frame.  
18 A I think January.  
19 Q (By Mr. Wells) Okay, so -- But as you sit here  
20 today, you can't tell based on that whether it's a  
21 short-barreled rifle as it's constructed right now?  
22 (The requested portion of the  
23 record read by the reporter.)  
24 A It is a short-barreled rifle.  
25 Q (By Mr. Wells) There's no barrel on it,

Page 162

1 though; right?  
2 A Correct.  
3 Q So you can't really call it a short-barreled  
4 rifle at this point without knowing actually how many  
5 inches the barrel is; is that right?  
6 A I would agree with you, but I have seen the  
7 barrel that goes with this gun.  
8 Q Where have you seen it?  
9 A At Benbow City Sports.  
10 Q Is that Mr. Maag's firearm business?  
11 A Correct.  
12 Q Have you been a customer of Mr. Maag's firearm  
13 business?  
14 A I have.  
15 Q On how many occasions have you been a customer  
16 of Mr. Maag's in his firearm business?  
17 A Four times.  
18 Q And what have you purchased on those four  
19 occasions?  
20 A A Beretta -- What's that thing called?  
21 Tomcat. Dan Wesson .357. I don't remember the others.  
22 Q Over what time period have you been a customer  
23 of Mr. Maag's firearm business?  
24 A I think the last three years.  
25 Q Approximately how much money have you spent on

Page 163

1 firearms and firearms products at Mr. Maag's business, his  
2 firearms business?  
3 A I don't know.  
4 Q Would you say it's over a thousand dollars?  
5 A Oh, yeah.  
6 Q Would you say it's over \$5,000?  
7 A I don't think so.  
8 Q So you would say it's between 1,000 and  
9 \$5,000?  
10 A I think so.  
11 Q So you have spent approximately between 1 and  
12 \$5,000 at Mr. Maag's firearm business; is that right? Over  
13 the last three years?  
14 A Yes.  
15 Q Mr. Maag showed you a variety of different  
16 receivers. Do you recall that?  
17 A I do.  
18 Q And those receivers are in front of you here  
19 on the table; is that right?  
20 A Yes.  
21 Q Have you ever personally purchased a receiver  
22 for a firearm by itself?  
23 A I think so.  
24 Q When did you make that purchase?  
25 A January.

Page 164

1 Q What did you purchase?  
2 A I don't remember exactly what they were.  
3 Q What they were? Was there more than one?  
4 A Yes.  
5 Q Approximately how many receivers did you  
6 purchase in January this year?  
7 A Two.  
8 Q Do you remember any other information about  
9 what kind of receivers those were?  
10 A No.  
11 Q Why did you purchase them?  
12 A They were on sale.  
13 Q Where did you purchase them from?  
14 A From Mr. Maag at Benbow City Sports.  
15 Q Were they custom-built receivers?  
16 A No.  
17 Q Do you know who the manufacturer of the  
18 receivers were?  
19 A I don't remember.  
20 Q Other than purchasing two receivers in January  
21 of this year from Mr. Maag, have you ever purchased  
22 receivers by themselves at any other time?  
23 A I don't remember.  
24 Q So as you sit here today, the only time that  
25 you can remember purchasing receivers only is those two



Page 165

1 receivers that you purchased from Mr. Maag in January of  
2 this year; is that fair to say?  
3 A Yes.  
4 Q You mentioned -- You were asked about a bolt  
5 for the AK-47.  
6 MR. MAAG: Right in front of you.  
7 Q (By Mr. Wells) Oh, right there. Sorry.  
8 Thanks. Do you recognize this?  
9 A I do.  
10 Q Before when I asked you if you had ever held  
11 an AK-47, you said that you had not; is that right?  
12 A Right.  
13 Q But you were still able to recognize this as  
14 an AK-47 bolt?  
15 A Yeah.  
16 Q And how?  
17 A The videos that tore them down and put them  
18 back together and -- oh, you remember R. Lee Ermey?  
19 Q Yes.  
20 A He had -- He had a side-by-side episode and  
21 they tore that down and put it back together.  
22 Q Was it this very bolt?  
23 A I don't know if it's specifically the one in  
24 your hand. No, I don't think so, but it was that.  
25 Q So you are basing your knowledge of what this

Page 166

1 is based on a visual comparison of a video you saw on  
2 YouTube involving R. Lee Ermey?  
3 A I don't think it was YouTube. I think it  
4 was -- What was his show's name? I think it was Locked and  
5 Loaded [sic] with R. Lee Ermey, I think. I think it was on  
6 The History Channel.  
7 Q So you were basing your assessment of what I'm  
8 holding in my hand being a part for an AK-47 based on a  
9 program that you watched on The History Channel with R. Lee  
10 Ermey as the host; is that right?  
11 A Yes.  
12 Q And that's -- Were you basing it on anything  
13 else?  
14 A No.  
15 Q Have you ever taken this part and put it in an  
16 AK-47 or combined it with other parts to assemble an AK-47  
17 and fired it?  
18 A I don't think so.  
19 Q So you -- As you sit here today, you don't  
20 know whether this particular part would actually function  
21 if assembled with other AK parts into an AK-47?  
22 A Correct.  
23 Q And you mentioned earlier that the M1 Garand,  
24 you're not sure whether or not that would be classified as  
25 an AK-type; is that right?

Page 167

1 A Correct.  
2 Q Do you agree that the first AK-type was the  
3 AK-47; is that right?  
4 MR. MAAG: Calls for speculation.  
5 (The requested portion of the  
6 record read by the reporter.)  
7 A That would be one way to look at it. That  
8 would be one way to look at it.  
9 Q So you agree?  
10 A I guess, yes.  
11 Q And the 47 in AK-47 refers to 1947; right?  
12 A It may. I can't remember if he developed it  
13 during World War II or after.  
14 Q Because World War II ended in 1945; right?  
15 A Right.  
16 Q And the M1 Garand was the standard-issue  
17 infantry weapon in World War II for the United States;  
18 right?  
19 A I don't know. There was a lot of guys with  
20 Tommy guns.  
21 Q How about D-Day, are you familiar with D-Day?  
22 A Yeah.  
23 Q When the soldiers were getting off the boats,  
24 American soldiers, were they carrying M1 Garands?  
25 A I believe they were.

Page 168

1 Q And D-Day was in 1944; right?  
2 MR. MAAG: Objection. Vague. D-Day?  
3 Q (By Mr. Wells) D-Day, June 6th, 1944, invasion  
4 of Normandy, you're familiar with that?  
5 A I am.  
6 Q The invasion of Normandy, where U.S. troops --  
7 A Stormed the beach.  
8 Q -- stormed the beaches at Normandy, they were  
9 carrying M1 Garands; right?  
10 A I believe many of them were.  
11 Q And that was 1944?  
12 A Yes.  
13 Q And prior to that, the U.S. had been involved  
14 in World War II; is that right?  
15 A I don't know how to answer that. I mean, I  
16 know they were involved in the Lend-Lease program, but I  
17 don't know exactly how many boots were on the ground prior  
18 to D-Day.  
19 Q Do you have any understanding as to whether or  
20 not American soldiers were carrying the M1 Garand in battle  
21 in World War II prior to June 6th, 1944?  
22 A I think they were carrying them in the African  
23 campaign.  
24 Q And that would have been in 1943, for  
25 instance; is that right?

Page 169

1 A Yes.  
2 Q And 1942?  
3 A I don't remember all the dates.  
4 Q And the M1 Garand was developed in the 1930s;  
5 right?  
6 A I don't remember.  
7 Q Okay. But you were aware that it was  
8 developed before World War II started; right?  
9 A Yes.  
10 Q And the United States didn't get involved in  
11 World War II until December 7th, 1941, Pearl Harbor; right?  
12 A I don't think we put boots on the ground until  
13 that day.  
14 Q So if the AK-47 was developed in 1947, that  
15 would have been after the M1 Garand; is that right?  
16 A Correct.  
17 Q So there were changes between the M1 Garand  
18 and the AK-47; is that right?  
19 A Yes.  
20 Q AK-47 as originally designed by Kalashnikov  
21 was a fully automatic rifle; is that right?  
22 A Yes.  
23 Q And the M1 Garand was a semi-automatic rifle;  
24 is that right?  
25 A I'm not sure.

Page 170

1 Q So you don't know whether --  
2 A Yes, they were.  
3 Q -- M1 Garand --  
4 A Because the click, click, click, click, ping,  
5 reload.  
6 Q So the M1 Garand was a semi-automatic rifle;  
7 correct?  
8 A Yes.  
9 Q And the M1 Garand used a fixed internal  
10 magazine or -- with a clip; is that right?  
11 A Right.  
12 Q And in fact, the M1 Garand was subsequently  
13 replaced by fully automatic firearms in the U.S. military;  
14 correct?  
15 A Yes.  
16 Q And part of the reason that the U.S. military  
17 replaced the M1 Garand was to match the fully automatic  
18 capability of the AK-47; is that right?  
19 (The requested portion of the  
20 record read by the reporter.)  
21 A I think you're right.  
22 Q (By Mr. Wells) Were the receivers that you  
23 purchased from Mr. Maag in January of this year, did you  
24 purchase those before or after January 10th, 2023?  
25 A Before.

Page 171

1 Q Before?  
2 A (Witness nods head affirmatively.)  
3 MR. WELLS: I don't have any further questions  
4 at this time. Subject to my prior objections.  
5 MR. MAAG: I don't think I have any further.  
6 Do you want to read this, look for typos, or  
7 do you want to waive signature? You can't change your  
8 answer, but you can correct typos.  
9 THE WITNESS: I waive signature.  
10 MR. WELLS: Let the record reflect that the  
11 witness waived signature.  
12 THE VIDEOGRAPHER: This ends the  
13 video-recorded deposition of Matthew Wilson. We are going  
14 off the record. The time now is 1:52.  
15 THE REPORTER: Transcript orders?  
16 MR. MAAG: E-tran.  
17  
18 SIGNATURE WAIVED, BY AGREEMENT OF COUNSEL  
19 AND WITNESS.  
20  
21 (Deposition was adjourned at 1:52 p.m.)  
22  
23  
24  
25

Page 172

1 CERTIFICATE OF REPORTER  
2  
3 I, Jamie Jo Kinder, CCR No. 842, CSR No.  
4 084.003306, do hereby certify that the witness whose  
5 testimony appears in the foregoing deposition was duly  
6 sworn by me; that the testimony of said witness was taken  
7 by me to the best of my ability and thereafter reduced to  
8 typewriting under my direction; that I am neither counsel  
9 for, related to, nor employed by any of the parties to the  
10 action in which this deposition was taken, and further that  
11 I am not a relative or employee of any attorney or counsel  
12 employed by the parties thereto, nor financially or  
13 otherwise interested in the outcome of the action.  
14  
15 \_\_\_\_\_  
16 Certified Shorthand Reporter  
17  
18  
19  
20  
21  
22  
23  
24  
25

<hr/> <b>\$</b> <hr/>	136:4 137:5,15 158:4	<b>18</b> 51:21 52:8 99:8,13	4 67:2 68:24 73:7 74:13 76:2,3 95:8 102:8 111:23 134:4 137:19,25
<b>\$12.09</b> 64:19	<b>114th</b> 31:8 55:19 56:4 59:15	<b>18-round</b> 52:13	<b>2-2-5</b> 92:16,17
<b>\$5,000</b> 163:6,9,12	<b>117-1</b> 34:6	<b>1800s</b> 137:3	<b>20</b> 58:15 104:2,5, 6,13,15,19,20 105:4,16 106:1, 11,23 107:5,11,16
<hr/> <b>(</b> <hr/>	<b>11:10</b> 75:19	<b>19</b> 28:5 101:13,16 103:7,18,23	<b>2003</b> 77:12
<b>(a)(1)(a)</b> 97:18	<b>11:18</b> 75:22	<b>1911</b> 147:20 148:1,2 158:20,25 159:11,14 160:12	<b>2006</b> 75:2 157:22
<hr/> <b>1</b> <hr/>	<b>12</b> 95:10,17,22 96:1 97:25 98:4 158:4	<b>1930s</b> 169:4	<b>2009</b> 8:9
<b>1</b> 20:24,25 21:6 27:20 92:15 112:14,15 121:5,6 163:11	<b>12-gauge</b> 39:7	<b>1941</b> 169:11	<b>201</b> 5:17
<b>1,000</b> 163:8	<b>12:25</b> 119:10	<b>1942</b> 169:2	<b>2015</b> 17:9
<b>1.9</b> 100:13,18 106:15	<b>12:31</b> 119:13	<b>1943</b> 168:24	<b>2023</b> 5:11 27:21 60:13 94:20 107:12,20 123:16, 22 124:5,6,14 126:16,22 132:23 135:9 170:24
<b>1.9A2C</b> 107:23	<b>12:57</b> 133:24	<b>1944</b> 168:1,3,11, 21	<b>20th</b> 136:23 137:1
<b>10</b> 13:17 49:15 53:15 58:15,19 59:23 60:13 61:3 81:5 107:12 111:22,24 112:2, 3,15 121:4 122:3 128:16,19,21 158:4	<b>12:59</b> 134:2	<b>1945</b> 167:14	<b>22</b> 43:25 44:5,10 111:5 113:24,25 114:2,12,15,18
<b>10-round</b> 52:24 53:10,18,23,24 54:2,11 81:9 125:25	<b>13</b> 96:1,24 158:4	<b>1947</b> 167:11 169:14	<b>225</b> 92:15
<b>100</b> 40:22 42:4,8	<b>14</b> 27:25 158:4	<b>1950s</b> 84:22 85:1	<b>22s</b> 44:13
<b>102-1116</b> 11:1,9	<b>141</b> 93:6	<b>1960s</b> 89:7	<b>23</b> 61:17 95:9
<b>1022</b> 22:2	<b>15</b> 12:1 13:16 17:6 20:8 26:10 35:8 48:5,6,8 51:16,23 52:3,21 59:23 61:3 80:16 93:20 95:24,25 96:12,15 110:11 111:5 114:25 115:8 142:18 143:1 158:4,11,12	<b>1978</b> 15:3	<b>23-cv-0029</b> 34:6
<b>10th</b> 60:3 94:20 123:15,21 124:5, 6,14 126:22 135:9 170:24	<b>15-round</b> 48:9 52:12 61:6 80:7	<b>1980s</b> 65:8,18,25	<b>23-cv-192-spm</b> 6:13
<b>11</b> 35:8 131:10,13, 22,23 133:7 134:16 135:18	<b>15.0</b> 116:15	<b>1990</b> 66:13	<b>24</b> 25:15
	<b>153</b> 55:24 56:3	<b>1990s</b> 69:16,18	<b>243</b> 146:14
	<b>15981</b> 144:10	<b>1999</b> 67:16 69:13 70:3	<b>27</b> 36:1 61:16 95:9 107:20
	<b>15th</b> 93:21	<b>19th</b> 27:21 121:4 126:16 137:2	<b>27th</b> 66:16 73:7 99:8 111:23 134:4
	<b>16</b> 35:10	<b>1:07</b> 140:16	<b>28</b> 21:7
	<b>17</b> 99:7 101:2	<b>1:08</b> 140:19	<b>2A2</b> 100:18
	<b>1746</b> 21:7	<b>1:52</b> 171:14,21	
		<b>1st</b> 7:9	
		<hr/> <b>2</b> <hr/>	
		<b>2</b> 33:8,12 34:4 49:18 61:18 65:3,	

<b>3</b>	<b>43</b> 34:8 101:23 102:8,19 103:19 110:20,21,25 111:18 134:9,14, 15,17 135:3,4,18 137:19,25	<b>609</b> 20:5	157:7
<b>3</b> 41:1,3,8	<b>47</b> 167:11	<b>6A</b> 62:1 65:4 66:16	<b>92A</b> 13:15 23:1
<b>30</b> 61:4 155:2 159:21	<b>5</b>	<b>6B</b> 67:1 68:23 69:15	<b>97</b> 16:17 68:3
<b>30-round</b> 59:23	<b>5</b> 55:15,18 56:4 59:15	<b>6C</b> 70:9 76:3,11 78:6	<b>9:40</b> 5:1,12
<b>300</b> 45:7	<b>5.56</b> 37:20 39:14 45:14 58:21,25 117:9	<b>6D</b> 78:11	<b>9C</b> 70:8
<b>308</b> 38:4,9 94:1,3, 8 146:14 150:8	<b>5/24-1.9</b> 97:17	<b>6th</b> 168:3,21	<b>A</b>
<b>33</b> 19:18,19 73:5,6	<b>5/24-91A1</b> 97:3	<b>7</b>	<b>A-R</b> 85:3
<b>33-round</b> 19:22	<b>50</b> 11:21 12:12,13, 15 39:6,9	<b>7</b> 97:13,16 100:12 106:15 107:23 108:12 125:1 149:19 150:10	<b>a.m.</b> 5:1
<b>338</b> 42:21 43:12, 15 44:2,4,9,12 45:8	<b>500</b> 12:14	<b>7.62</b> 58:21,22,25 114:5,6 127:6 132:12	<b>A2</b> 100:18
<b>357</b> 162:21	<b>50s</b> 26:6,8,16 83:25	<b>720</b> 97:2,17	<b>ability</b> 10:18,22
<b>35_alpha</b> 145:23	<b>51</b> 38:5 90:21,22	<b>75</b> 45:5 62:1 64:15,20,25 65:9	<b>absent</b> 7:16 27:17
<b>363</b> 59:10,11,14	<b>54</b> 38:5,9	<b>76</b> 38:4	<b>accept</b> 45:20 155:6,9
<b>37</b> 110:7,8	<b>556</b> 41:16,17 42:1	<b>762</b> 38:5,7,9 56:17	<b>accessorizing</b> 89:22
<b>381517</b> 149:17	<b>556-millimeter</b> 41:18	<b>7th</b> 169:11	<b>accidentally</b> 76:22
<b>39</b> 132:12	<b>56</b> 124:23	<b>8</b>	<b>accuracy</b> 25:25
<b>3:23-cv-209-spm</b> 5:14	<b>57</b> 83:11	<b>8</b> 115:18,21	<b>accurate</b> 42:9 58:7 143:21
<b>3rd</b> 5:11 15:3	<b>5900</b> 67:3 68:25 69:5,9,21,25	<b>80</b> 25:9,10	<b>acknowledge</b> 96:2
<b>4</b>	<b>5G</b> 50:5	<b>8th</b> 132:23	<b>acquire</b> 75:15 93:22 123:16,18 124:7,15 135:10
<b>4</b> 48:12,14,16,21 50:25 54:7	<b>6</b>	<b>9</b>	<b>ACR</b> 154:12
<b>4-0</b> 73:21,22	<b>6</b> 87:7,10 92:18 109:20	<b>9</b> 119:15,17,20	<b>acres</b> 25:9
<b>4-inch</b> 51:18	<b>6.5</b> 42:19	<b>9-bolt</b> 82:19	<b>Acronym</b> 11:4
<b>40</b> 73:20 74:13	<b>6/27/23</b> 34:7	<b>9-millimeter</b> 37:20 39:13,14 40:8,11, 14 42:7 44:19 45:15 46:2 67:6 72:16,20,23 146:6	<b>act</b> 11:1 96:5,17
<b>41</b> 111:8			<b>action</b> 6:23 24:8,9 100:22 106:20
<b>410</b> 18:16			<b>actual</b> 36:17
<b>42</b> 134:9,14,15,17 135:3,4,18 136:3 137:5,15			<b>add</b> 7:11 23:18 118:23
			<b>added</b> 82:10
			<b>addition</b> 45:17 101:16 103:11

<p><b>additional</b> 6:22 57:10 139:8</p> <p><b>address</b> 14:25</p> <p><b>adjourned</b> 171:21</p> <p><b>adjusted</b> 82:5</p> <p><b>admittedly</b> 91:6</p> <p><b>adopted</b> 41:24</p> <p><b>advance</b> 124:10</p> <p><b>advertise</b> 47:19</p> <p><b>advertised</b> 47:18 81:3</p> <p><b>advertisement</b> 130:14</p> <p><b>advertises</b> 82:6</p> <p><b>advertising</b> 47:24 132:1,3</p> <p><b>advised</b> 76:18</p> <p><b>advises</b> 77:10</p> <p><b>Aero</b> 151:13</p> <p><b>affect</b> 10:18 132:24</p> <p><b>affects</b> 44:16</p> <p><b>affidavit</b> 34:5 49:20,24 60:25 61:17 69:21,25 106:3 107:21 111:23 134:5</p> <p><b>affirmatively</b> 10:15 19:20 28:12,17 34:11 171:2</p> <p><b>affixed</b> 160:15</p> <p><b>afford</b> 138:3</p> <p><b>affordable</b> 74:8,15</p> <p><b>African</b> 168:22</p> <p><b>aftermarket</b> 81:13, 14 126:1</p>	<p><b>age</b> 8:1 27:25</p> <p><b>agree</b> 37:16 44:15 46:4,17,18,21,24 47:2 48:4 74:20, 22,25 76:25 84:10,24 96:23 97:24 98:14 106:22 116:22 122:20 123:5,9 127:16 129:20 131:21 161:4 162:6 167:2,9</p> <p><b>agreeable</b> 139:14</p> <p><b>AGREED</b> 5:2</p> <p><b>AGREEMENT</b> 171:18</p> <p><b>ahead</b> 11:19 16:4 20:23 46:7 64:7 71:21 144:19 150:7</p> <p><b>airplane</b> 14:8</p> <p><b>AK</b> 27:7 122:15,18 125:20 126:9 130:7,9,12,20 131:3,5 132:22,25 133:3,10,14 138:10,15 166:21</p> <p><b>AK-47</b> 122:8,15,20 123:7,11 127:7, 19,23 129:2,7,11, 21 130:2,6,7,13, 24 131:6,18 132:14,17 133:21 138:5 153:1,9,21 165:5,11,14 166:8,16,21 167:3,11 169:14, 18,20 170:18</p> <p><b>AK-47S</b> 122:7 123:1</p> <p><b>AK-56</b> 124:20</p> <p><b>AK-74</b> 124:17</p>	<p><b>AK-P</b> 130:15,18,23 131:2</p> <p><b>AK-TYPE</b> 13:24 109:22 112:1,18, 21 121:12,20 123:13,16,18,22 124:3,7,15 125:13 131:23 132:3,8 138:7 154:3 166:25 167:2</p> <p><b>AK-TYPES</b> 125:4, 10</p> <p><b>AKS</b> 14:3 132:25</p> <p><b>alcohol</b> 10:21</p> <p><b>allowed</b> 11:25 13:17 18:4 60:10 139:22</p> <p><b>allowing</b> 155:18</p> <p><b>Alpha</b> 144:10</p> <p><b>altered</b> 154:2</p> <p><b>ambiguity</b> 35:12</p> <p><b>Amendment</b> 6:23 20:16,18 139:7</p> <p><b>American</b> 29:24 41:23 75:25 88:7, 16 167:24 168:20</p> <p><b>ammunition</b> 12:12 28:8 37:25 39:23, 25 40:14 42:2,7, 19 44:19 47:17 80:12 81:2 114:6 157:7,11,23,24</p> <p><b>amount</b> 43:19</p> <p><b>animal</b> 84:23</p> <p><b>animals</b> 14:7</p> <p><b>answers</b> 9:16</p> <p><b>Anton</b> 122:17</p> <p><b>anymore</b> 31:15 52:9 60:19</p>	<p><b>anyone's</b> 79:13</p> <p><b>apologize</b> 10:17 68:11</p> <p><b>appeals</b> 25:23</p> <p><b>appearance</b> 117:18,19</p> <p><b>appears</b> 104:14</p> <p><b>Appendix</b> 92:15</p> <p><b>apples</b> 39:5</p> <p><b>applied</b> 17:2</p> <p><b>apply</b> 18:13 80:7</p> <p><b>approximately</b> 17:4 162:25 163:11 164:5</p> <p><b>April</b> 126:18,19</p> <p><b>AR</b> 29:17,19,20 82:6 85:7,16 86:2, 7,18,24 89:7,15, 16,17,18,19 90:11,13,16,23 91:9,13,18,20 92:12,19 93:5,18 94:9 96:17,19 100:3 109:11 117:18 118:1,5,9, 12,14,17,24 119:1</p> <p><b>AR-10</b> 24:20 25:1, 5,22 26:2,23 93:23,25 94:4,9, 12 129:1 149:24 150:1,13 151:15</p> <p><b>AR-10S</b> 151:23</p> <p><b>AR-15</b> 23:24 24:2, 3 26:17,21 27:10, 14,17 37:20 39:14,15 45:14 82:2 83:3,8,9,13 84:6,10,17,20 86:13,18,19,21 93:4,17 94:12 98:15 101:17</p>
--	---	--	--



103:12 104:8,16, 17,20 105:4,13,17 106:1,7 116:14, 18,23 117:1 118:20 119:4,6,23 129:1 149:24 150:1,13 151:16 <b>AR-15.COM</b> 30:6 <b>AR-15S</b> 87:11 92:18 151:23 <b>AR-24</b> 65:8 66:15, 17,22,24 <b>AR-5</b> 98:25 99:4,9, 16,23 100:3,8 101:1 <b>AR-7</b> 94:14,16,19, 24 95:2,11 96:3,4, 8,23 97:21,24 98:11,14,19,22 <b>AR-70</b> 154:14 <b>AR-STYLE</b> 89:5, 10 90:4,25 91:3 117:9,14 <b>AR-TYPE</b> 13:23 14:10 26:2,11,20, 23 81:20 82:12 93:9,13 96:7,9,11 99:24 109:19,24 111:1,15,19,20 112:1,18,21 113:1,4,17,21 114:1,4,7,11,19 115:2,9 120:22 121:12,21 122:1 148:19 149:19,20, 24 150:2,10,13 151:15 <b>AR-TYPES</b> 108:13,20 109:1, 8,17 110:3,5 111:10 121:2 151:24 154:9 <b>Armalite</b> 26:10	65:9 66:17,20 82:2 85:14 93:19 111:5 113:24,25 114:12,15,18 <b>Armory</b> 78:12 79:24 80:4 82:19 128:1,3,7,10,13, 22 130:6 131:15 149:12,21 152:18 <b>Armory's</b> 130:23 <b>Arms</b> 98:22 132:21,22 <b>ARS</b> 89:22,25 90:7 92:1,5,24,25 120:2,14,15 <b>article</b> 92:2 <b>articles</b> 32:13 <b>ARX</b> 40:22 42:4,7 <b>aspect</b> 132:16 <b>assault</b> 96:25 100:9,19 101:6 106:18 107:5 150:22 <b>assemble</b> 166:16 <b>assembled</b> 147:11 148:14 149:8,9 159:4,15 166:21 <b>asserting</b> 20:17 <b>assessment</b> 166:7 <b>assistance</b> 160:6 <b>assistant</b> 88:7 <b>associate's</b> 14:18, 19,24 <b>associates</b> 139:25 <b>Association</b> 88:6 <b>assume</b> 7:19 9:22 60:22 64:17 139:19 142:2	<b>assuming</b> 53:3,11 90:5 118:19 142:18 143:1 148:14 155:5,7,9 156:21 <b>ATF</b> 160:17,18,22 161:11 <b>attach</b> 148:13 <b>attached</b> 160:12 <b>attaching</b> 148:13 <b>attachment</b> 63:6, 8,18,19,20 64:14 116:14 <b>attention</b> 21:18 34:3,7,25 35:3 41:7 49:17 50:24 54:5 55:24 56:3,9 59:16 61:16,25 62:11 65:2 67:1 68:23 70:7 73:10, 19 78:10 87:25 89:3 90:9,20,22 91:5 92:14 95:7, 24 97:17 99:7 100:11,15 101:13, 22 106:14 108:11, 12 111:22 117:5, 22 118:10 119:22 121:3 125:1 129:23 130:1,21 131:17 132:10,19 133:6 134:4 <b>attorney</b> 11:14 12:22 13:22 17:15 21:17 <b>attorneys</b> 5:20 <b>audio</b> 9:2 <b>author</b> 88:2 92:23 118:9 <b>automatic</b> 137:14, 22 169:21 170:13, 17	<b>avoid</b> 57:13 <b>aware</b> 43:15 50:21 65:24 66:12 68:4 75:1,2 77:9 82:21 91:25 92:5,8 99:9 113:15,19 142:15 153:8 169:7 <b>awesome</b> 43:14 <hr/> <b>B</b> <hr/> <b>bachelor's</b> 14:17 <b>back</b> 6:24 13:4 23:10 26:5,8,16, 22 33:12,15 49:17 59:2 61:16,23 63:2 65:2 68:18, 23 75:22 76:1,2,3 77:7,14 80:18 81:16 84:25 91:8 95:9 98:5 103:9 106:14,15 112:13 119:13 121:3 124:25 134:2,4, 20,21 139:7 140:19 158:2 159:22 165:18,21 <b>background</b> 14:13 <b>bad</b> 17:12 24:24 26:14 39:17,20 69:4 87:24 127:15 <b>balance</b> 138:17 <b>ban</b> 150:23 153:25 154:19 155:7 <b>bang</b> 147:15 <b>bankruptcy</b> 66:12 <b>banned</b> 151:19 154:9,17 155:11 <b>banner</b> 128:24 <b>Barnett</b> 5:13 6:23 <b>barrel</b> 38:22 39:1 57:2,3,15,16 72:8
--	--	---	---

<p>148:15 161:3,7,9, 25 162:5,7</p> <p><b>based</b> 46:11 52:1 66:2 96:11,15 153:25 161:20 166:1,8</p> <p><b>basic</b> 70:11 76:5</p> <p><b>basing</b> 131:25 165:25 166:7,12</p> <p><b>basis</b> 20:14 77:22</p> <p><b>bathroom</b> 10:9</p> <p><b>battle</b> 168:20</p> <p><b>beach</b> 168:7</p> <p><b>beaches</b> 168:8</p> <p><b>bearer</b> 155:18,19</p> <p><b>beautiful</b> 118:1</p> <p><b>beauty</b> 133:11</p> <p><b>beginning</b> 23:2 139:4,16</p> <p><b>behalf</b> 5:22,24 6:1 8:2</p> <p><b>Belgian</b> 105:20</p> <p><b>believes</b> 92:23 118:9</p> <p><b>belong</b> 35:16</p> <p><b>Benbow</b> 150:21 151:2,3 152:15 162:9 164:14</p> <p><b>benefit</b> 16:21</p> <p><b>Beowulf</b> 12:15</p> <p><b>Beretta</b> 13:15,17 23:1 37:19 39:13 40:7,10,13,14,22 41:9 42:2 45:15, 25 78:14,16 79:24 80:4 154:14 157:2,5 162:20</p> <p><b>Bible</b> 31:5,8,9,11 55:19,21 56:4</p>	<p>59:9,15 87:11,16, 19 92:18</p> <p><b>bicycling</b> 18:24</p> <p><b>bird</b> 43:25</p> <p><b>birth</b> 15:2</p> <p><b>bit</b> 14:12 18:23 28:9 51:4 83:1 153:6</p> <p><b>black</b> 12:16 128:24</p> <p><b>blanket</b> 82:12</p> <p><b>blue</b> 62:13 73:6</p> <p><b>blunt</b> 15:23</p> <p><b>BMG</b> 11:21 12:12, 13 39:6,9 134:25 136:15,16</p> <p><b>boats</b> 167:23</p> <p><b>Bob</b> 91:24</p> <p><b>bolt</b> 24:9 40:4 64:2 101:3 102:9,10, 11,12 106:20 107:21,22 153:3,9 165:4,14,22</p> <p><b>bolt-action</b> 99:14, 17,19 101:18 102:2,15 103:12, 13,16,24,25</p> <p><b>bolt-pump</b> 100:21</p> <p><b>bolted</b> 63:9,22</p> <p><b>bombarded</b> 120:4</p> <p><b>Bond</b> 48:25</p> <p><b>book</b> 55:6 87:13 88:24 89:5,14</p> <p><b>books</b> 28:23,24 32:13</p> <p><b>boots</b> 168:17 169:12</p> <p><b>born</b> 137:2</p>	<p><b>bottom</b> 21:13 34:12 41:10 50:5 52:23 53:6 55:25 56:8,12,14 74:10, 13 95:25 100:13 102:12 115:22 118:11,23 119:24 131:15 132:11,20 134:13 141:15 146:5</p> <p><b>bought</b> 123:24</p> <p><b>bow</b> 45:6</p> <p><b>boxes</b> 44:13 139:18 140:6</p> <p><b>brand</b> 151:12</p> <p><b>brands</b> 130:8</p> <p><b>break</b> 10:7,9,14 42:16 54:21 74:3, 6 75:17,20 115:12 119:8,11 133:22, 25 140:17</p> <p><b>Bridgeport</b> 78:23</p> <p><b>briefly</b> 92:19</p> <p><b>broad</b> 11:19 81:24,25</p> <p><b>brought</b> 35:15 139:17 140:9</p> <p><b>Browning</b> 134:24 136:15,17,22,25</p> <p><b>Bs</b> 150:24</p> <p><b>build</b> 29:17,19 91:18 92:5</p> <p><b>building</b> 43:25 44:1</p> <p><b>builds</b> 25:24 91:20</p> <p><b>built</b> 91:25 92:12</p> <p><b>bullet</b> 38:19,20,23 39:2,3</p> <p><b>bunch</b> 127:11</p>	<p><b>burned</b> 155:20</p> <p><b>Bushmaster</b> 154:12</p> <p><b>business</b> 15:8 20:20 29:3 33:3 66:10 93:15 151:2 162:10,13,16,23 163:1,2,12</p> <p><b>businesses</b> 15:12</p> <p><b>buttstock</b> 57:24, 25 105:9 160:12</p> <p><b>buy</b> 12:1,16,18 47:5,15 60:5 64:19 80:16 81:5 99:4 137:24</p> <p><b>buying</b> 80:10,15, 25 81:4 82:8,9 126:24 128:9</p> <hr/> <p style="text-align: center;"><b>C</b></p> <hr/> <p><b>Caleb</b> 5:13</p> <p><b>caliber</b> 25:22 36:12,14,22 37:4, 9,20,25 39:23 40:10,18 41:14, 19,20,21,24 42:1 43:13,21,23 44:15 45:12,13,17 47:16 56:19,20 59:1,7 72:1,3,6,14,17,20, 23 73:1,13,17,24 74:1,8,15,21,23 80:12 81:2 86:4 114:10 127:5,7,22 132:12,14,16 138:18 146:14 150:8 155:2 157:7,11,15,19,25 160:9</p> <p><b>calibers</b> 42:14 43:18</p> <p><b>California</b> 53:16,</p>
---	---	--	--

<p>17,21</p> <p><b>call</b> 41:23 56:19 57:18 71:19 84:19 162:3</p> <p><b>called</b> 46:5,19,22 56:20 63:11 71:7, 13 84:10,17 97:6 99:9 109:19 115:1 126:8 154:24 162:20</p> <p><b>calling</b> 120:22</p> <p><b>Calls</b> 29:21 101:7 107:7 109:2 155:14 167:4</p> <p><b>Camp</b> 67:6,11,15, 20,22,24 68:12 70:3</p> <p><b>campaign</b> 168:23</p> <p><b>capability</b> 154:2 170:18</p> <p><b>capacities</b> 59:22</p> <p><b>capacity</b> 12:25 19:7 36:21 47:23 48:1 51:13,18 52:8 59:19 80:7 154:20 155:6,9</p> <p><b>capital</b> 97:3</p> <p><b>capital--</b> 100:18</p> <p><b>capturing</b> 91:8</p> <p><b>carbine</b> 72:3,6,9, 17 111:5 113:24, 25 114:12,15,18 142:10,14,16 155:2,8,10,11 158:15,17</p> <p><b>carbine-style</b> 72:18</p> <p><b>carbines</b> 73:13,17 74:17,21,24</p> <p><b>card</b> 16:13,15,18, 21,23</p>	<p><b>Carden</b> 5:19</p> <p><b>care</b> 21:3 25:18 36:11</p> <p><b>Carmel</b> 14:15</p> <p><b>Carolina</b> 145:12</p> <p><b>carry</b> 16:23 17:22, 25 18:3,7,9,14,20 19:2,5,16,17,23, 24 20:2,4,6 32:3</p> <p><b>carrying</b> 19:2 167:24 168:9,20, 22</p> <p><b>cartridge</b> 45:21</p> <p><b>cartridges</b> 74:17</p> <p><b>case</b> 5:14 6:9,13 8:13,19 34:5 36:6 49:13 126:16 139:6</p> <p><b>catch</b> 63:12,14,18 64:10,14,24</p> <p><b>categorized</b> 125:13</p> <p><b>category</b> 46:4,19, 21 132:17</p> <p><b>CCR</b> 5:5</p> <p><b>century</b> 136:23 137:1,3</p> <p><b>cetera</b> 7:18</p> <p><b>chair</b> 68:18</p> <p><b>challenged</b> 96:5</p> <p><b>challenging</b> 10:25</p> <p><b>chamber</b> 48:3,10</p> <p><b>chambered</b> 74:17 94:6</p> <p><b>chambers</b> 94:3</p> <p><b>change</b> 82:25 139:14 171:7</p> <p><b>changed</b> 82:10</p>	<p>83:25 124:2,5</p> <p><b>changing</b> 98:10</p> <p><b>Channel</b> 166:6,9</p> <p><b>chapter</b> 90:11,12, 18,19</p> <p><b>chapters</b> 89:21</p> <p><b>characteristics</b> 105:23</p> <p><b>characterized</b> 111:1,19</p> <p><b>cheap</b> 57:12 94:5, 6</p> <p><b>cheated</b> 41:5</p> <p><b>China</b> 146:20</p> <p><b>Chinese</b> 127:11</p> <p><b>choice</b> 124:8,9</p> <p><b>choices</b> 120:4 121:2</p> <p><b>choose</b> 73:3 120:2,13 124:11</p> <p><b>chose</b> 140:7</p> <p><b>Chris</b> 68:16</p> <p><b>Christopher</b> 5:22</p> <p><b>circle</b> 38:25</p> <p><b>Circuit</b> 139:7</p> <p><b>circumstances</b> 10:3</p> <p><b>cited</b> 70:6</p> <p><b>City</b> 150:21 151:2, 3 152:15 162:9 164:14</p> <p><b>claim</b> 12:24 13:2, 13,25</p> <p><b>claims</b> 6:8,21,23 11:15 12:23 13:21 139:6,8</p> <p><b>clarify</b> 9:24 17:15</p>	<p>23:15 57:1 93:17 139:15</p> <p><b>classified</b> 115:8 166:24</p> <p><b>clean</b> 9:17 17:11</p> <p><b>clear</b> 17:18 147:10</p> <p><b>click</b> 170:4</p> <p><b>client</b> 17:16</p> <p><b>Cliffsnotes</b> 55:22</p> <p><b>clip</b> 146:12 159:25 160:5 170:10</p> <p><b>clone</b> 65:9</p> <p><b>close</b> 38:12,21,22 39:2 58:5 96:7 112:25</p> <p><b>CMR-30</b> 22:14,19</p> <p><b>coffee</b> 31:15</p> <p><b>Collect</b> 95:4</p> <p><b>collection</b> 116:4</p> <p><b>College</b> 14:15 29:1</p> <p><b>Colt</b> 83:15 84:8</p> <p><b>Columbia</b> 145:12</p> <p><b>Colyer</b> 146:12 159:25 160:5</p> <p><b>combinations</b> 11:23</p> <p><b>combined</b> 166:16</p> <p><b>comfortable</b> 55:3</p> <p><b>commenced</b> 5:1</p> <p><b>comment</b> 109:7 118:22 133:8</p> <p><b>common</b> 14:5 27:22 28:4 58:25 59:5 71:15,16,18 72:23 73:1 127:22 129:10,21</p>
--	---	---	--

<b>commonly</b> 42:14 154:24	<b>concern</b> 36:1	<b>copy</b> 25:25 55:20 153:15 154:1	96:16 98:11 100:8
<b>Communities</b> 11:1	<b>concerned</b> 86:5, 11 148:23	<b>corner</b> 41:12 56:12 59:16	<b>COVID</b> 94:23,25 95:3
<b>compact</b> 51:10,22 52:3,11 53:7,25 72:12,13 74:8,15	<b>conclusion</b> 73:22 74:14 101:8 107:8 109:3 142:21 155:14	<b>correct</b> 6:12 19:25 23:13,18 27:1 37:17,21 39:15, 17,24 40:25 42:6, 8 47:24 52:18 56:6,22 59:1 62:20 66:18 67:16 69:6,8 73:18 80:13,17 81:6 95:23 96:22 97:1 98:9 103:25 109:22 111:3,7,16 113:1,2 121:9 123:2 125:8 127:21 129:8,21 131:9 135:8 136:12 137:13 147:13 150:7 151:4 152:16,17, 25 156:12 157:16 158:14 159:9 162:2,11 166:22 167:1 169:16 170:7,14 171:8	<b>creation</b> 123:7
<b>companies</b> 98:18	<b>conditions</b> 122:13	<b>corrections</b> 30:20	<b>credit</b> 17:20
<b>company</b> 8:20 21:22 98:22 115:15 136:25	<b>conducted</b> 140:8, 9	<b>cost</b> 135:18	<b>crime</b> 15:25 16:3
<b>compare</b> 26:5	<b>confused</b> 100:2 105:20 109:25	<b>counsel</b> 5:3 159:23 171:18	<b>crimp</b> 62:23
<b>compared</b> 20:2 45:14 74:16	<b>confusing</b> 14:11	<b>count</b> 93:7 129:24	<b>Croatian-made</b> 78:12
<b>comparing</b> 14:8 39:5 45:12	<b>confusion</b> 103:21	<b>counted</b> 93:6	<b>CSR</b> 5:5
<b>comparison</b> 146:23 166:1	<b>connecting</b> 87:4	<b>country</b> 127:9,23	<b>current</b> 14:25 88:23 90:25
<b>compatible</b> 141:25 142:4 152:4	<b>conned</b> 43:2	<b>couple</b> 12:21 31:14 126:3 130:22	<b>custom</b> 91:25 92:5
<b>Competition</b> 22:2	<b>considered</b> 18:23, 24 72:11 126:24 135:1	<b>court</b> 5:15 6:15,24 9:12,20 16:22	<b>custom-built</b> 91:9, 12 164:15
<b>complete</b> 89:5 130:7	<b>consolidated</b> 6:23	<b>courtesy</b> 10:11	<b>customer</b> 76:14, 18 77:9 162:12, 15,22
<b>completely</b> 10:19 13:18 108:22 155:18	<b>constitutionality</b> 10:25	<b>covered</b> 12:21	<b>customizing</b> 89:21
<b>compliance</b> 53:11, 12	<b>constructed</b> 50:17,19 161:21		<b>cut</b> 78:15,20 79:4, 7,10,20,22
<b>complication</b> 9:7	<b>consulted</b> 77:21		<b>cuts</b> 8:22
<b>comply</b> 57:14 60:24	<b>contents</b> 90:10		<b>cutting</b> 79:1
<b>compound</b> 115:3 141:20 155:13	<b>context</b> 69:24 90:6 92:25 116:3		<b>Cx4</b> 13:17 23:1 40:10,13
<b>comprehensive</b> 90:24	<b>continuing</b> 108:24		<b>cycle</b> 40:2,3 126:6 148:11
<b>concealed</b> 16:23 17:22,25 18:3,7, 14 19:2,17,22,23 20:6 32:3	<b>contract</b> 8:15		<b>cylinder</b> 100:23 106:21 107:1
	<b>control</b> 68:8		<b>CZ</b> 62:1 64:15,20, 25 65:9
	<b>converted</b> 126:4,5		
	<b>convicted</b> 15:25		<b>D</b>
	<b>cool</b> 55:1 134:15, 17		<b>D-DAY</b> 167:21 168:1,2,3,18
	<b>copies</b> 31:11 55:21		<b>dad</b> 68:1 86:11,13, 21

<b>damage</b> 32:24	<b>defines</b> 160:17	22 134:16 135:18	<b>Diameter</b> 56:18
<b>Dan</b> 162:21	<b>defining</b> 109:10	136:4 137:5,15,	<b>difference</b> 12:3,4
<b>Daniel</b> 115:14,22	<b>definite</b> 138:11	19,25 139:5,10,	126:9 143:11
116:15,22	<b>definition</b> 11:21	16,17 149:19	152:23 153:7
<b>date</b> 5:11 15:2	96:25 99:23 101:6	171:13,21	<b>differences</b>
136:21	<b>degree</b> 14:14,16,	<b>deputy</b> 32:3	114:22
<b>dates</b> 169:3	17	<b>describe</b> 85:4 94:4	<b>direct</b> 21:18 34:3,
<b>day</b> 107:17 169:13	<b>degrees</b> 14:20	103:24 104:23	25 35:3 49:17
<b>days</b> 7:11 49:15	<b>demonstrative</b>	<b>description</b> 64:1	50:24 54:5 55:24
120:3	148:7	<b>design</b> 26:17	56:9 61:16,25
<b>DDM4</b> 115:23	<b>department</b> 76:14,	83:18,21 84:3	62:11 65:2 68:23
116:14,23 117:11	18 77:10	85:1 129:10	73:5,19 76:1
<b>deadly</b> 44:13	<b>depend</b> 161:2	<b>designed</b> 43:9	78:10 87:25 89:3
<b>deal</b> 123:24	<b>depends</b> 39:18	58:2 83:9 122:9	90:9,20 92:14
<b>debate</b> 42:23	43:20 79:13	127:17,19 129:11	95:7 108:11 117:5
<b>decade</b> 73:12	<b>depicted</b> 63:19	153:21 169:20	119:22 121:3
<b>decades</b> 25:11	96:1,23 97:24	<b>designs</b> 141:9	130:21 134:3
123:6	98:4 99:16	<b>desire</b> 25:4 124:15	<b>directing</b> 34:7
<b>December</b> 169:11	102:14,19 104:12,	<b>destroy</b> 32:23	41:7 56:2 59:16
<b>declaration</b> 20:22	19 105:4,16	<b>destroyed</b> 60:18	67:1 70:7 73:10,
27:19,21 28:5	106:11,22 107:4,	<b>destroying</b> 62:24	23 90:22 91:5
36:1 49:13 50:8	10,16 130:19	<b>detachable</b> 109:21	95:24 97:17 99:7
65:3 67:2 68:24	131:22 135:2,18	125:18,25 155:6,9	100:11,14 101:12,
71:1 73:7,8 75:25	136:3 137:5,25	<b>detail</b> 98:13	22 106:14 108:12
76:1 95:9,10	<b>depo</b> 134:19	<b>details</b> 97:9	111:22 116:10
97:25 99:8 101:2	<b>deposed</b> 8:6,8,11,	116:13 132:11	117:22 118:10
121:4 126:16	14	<b>determination</b>	125:1 129:23
<b>declared</b> 66:12	<b>deposes</b> 8:2	78:6	130:1 131:17
<b>deer</b> 25:7,18	<b>deposition</b> 5:1,4,	<b>determine</b> 111:25	132:10,19 133:6
<b>defaults</b> 30:20	12,17 6:19,22	112:17 143:7	<b>discern</b> 96:8,10
<b>defective</b> 127:4	7:14 9:8,25 10:24	144:5	143:15,24 144:12,
<b>defendants</b> 5:3,23	11:2 20:25 33:8	<b>Deuce</b> 39:11	16,23 145:3,24
6:2 8:2	41:1,8 48:12,15,	<b>develop</b> 25:4 28:5,	146:7,15,21 147:3
<b>Defense</b> 115:14	20 49:12,18 54:7	21 94:22	<b>discontinue</b> 67:5
116:15,22	55:15,18 56:3	<b>developed</b> 28:11	<b>discontinued</b>
<b>Defense's</b> 115:22	59:15 62:18 87:7,	122:13 124:14	67:4,5,16 69:1,2,
<b>defined</b> 35:11 46:9	10 97:13,16	153:18 167:12	6,10,16,18 70:3
81:23 100:9	100:11 106:15	169:4,8,14	75:2
	115:18,20 119:17,	<b>dialed</b> 25:25	<b>discovery</b> 7:4,18
	20 122:3 128:16,		139:8,9 140:2,3,8,
	18,21 131:10,13,		9 141:3
			<b>discussed</b> 106:10
			<b>discussion</b> 111:21



140:23	<b>edition</b> 22:2 31:8 55:19 56:4 59:15	<b>Ermev</b> 165:18 166:2,5,10	97:13,16 100:12 101:23 102:8 106:15 107:23 108:12 111:23 112:4,14,15 115:18,21 116:11, 12 119:15,17,20 121:4,5,6 125:1 128:16,19,21 131:10,13,23 133:7 134:4,16 135:18 136:4 137:5,15,19,25 149:19 150:10
<b>discussions</b> 66:7	<b>editor</b> 88:7,23	<b>essential</b> 89:8	<b>exhibits</b> 62:7 75:24
<b>display</b> 31:15	<b>educational</b> 14:13	<b>et al</b> 5:13,14	<b>exist</b> 31:15
<b>dispute</b> 8:15 155:3	<b>EE</b> 150:6,8	<b>Eugene</b> 26:17 83:9 84:25	<b>expensive</b> 135:15
<b>distance</b> 79:3	<b>effect</b> 19:21 20:7 24:18 25:2 107:12 123:15,21 124:2, 13	<b>eventually</b> 84:1	<b>experience</b> 11:20
<b>district</b> 5:15 6:14, 24	<b>efficiency</b> 38:15, 16	<b>evolution</b> 70:20 71:3 84:22 89:6, 14	<b>expert</b> 32:7,11 49:13 53:20
<b>document</b> 21:6,8, 14,16 33:22 34:1, 6,19,22 88:9	<b>elegant</b> 25:21	<b>evolutionary</b> 84:25	<b>experts</b> 112:20,25 113:4,9,16,21 121:11,20
<b>dog</b> 18:23	<b>elements</b> 129:10	<b>evolved</b> 26:18 71:4	<b>expired</b> 82:24
<b>dogs</b> 18:25	<b>Eleven</b> 131:8	<b>EXAMINATION</b> 8:3 140:20 156:6	<b>explain</b> 94:2
<b>dollars</b> 163:4	<b>eliminated</b> 33:1	<b>examined</b> 8:1	<b>explode</b> 39:16,24 77:5,7
<b>doubt</b> 118:24	<b>else's</b> 153:15	<b>examples</b> 23:21, 23 37:3 70:4 107:25 112:19 121:7	<b>exploded</b> 120:25 121:1
<b>Doug</b> 88:2,5,12	<b>employed</b> 15:4	<b>exceeds</b> 61:6	<b>expressly</b> 5:7
<b>dream</b> 118:12	<b>employer</b> 15:6	<b>exception</b> 107:21	<b>extreme</b> 122:13
<b>Drive</b> 5:18	<b>enables</b> 57:25	<b>excerpt</b> 55:18 87:10	<b>eye</b> 138:20,21
<b>drugs</b> 10:21	<b>enacted</b> 19:10,16 75:14	<b>excerpts</b> 87:14	<b>eyes</b> 39:19 130:23
<b>due</b> 7:6,8 140:4	<b>encircles</b> 155:18	<b>excited</b> 28:7	
<b>Dukes</b> 122:22	<b>end</b> 78:25 79:1	<b>excluded</b> 101:5	<b>F</b>
<b>duplicate</b> 154:1	<b>ended</b> 167:14	<b>exhaustive</b> 91:1	
<hr/> <b>E</b> <hr/>	<b>endorsement</b> 60:25	<b>exhibit</b> 20:24,25 21:6 27:20 33:8, 12 34:4 41:1,3,8 42:13 48:12,16,21 49:18 50:25 54:7 55:15,18 56:4 59:15 63:16 65:3, 4 67:2,9 68:24 73:7,8 74:13 76:2, 3 87:7,10 88:1 90:10 92:18 95:8	<b>F-O-I-D</b> 16:23
<b>E-TRAN</b> 171:16	<b>ends</b> 171:12	<b>excites</b> 28:7	<b>facsimile</b> 154:2
<b>earlier</b> 23:2 24:15 35:15 39:12 40:7 62:18 72:10 77:13 83:7 90:10 93:16 97:20 116:6 122:3 125:6 158:19 160:1 166:23	<b>enforcement</b> 13:20	<b>excludes</b> 61:6	<b>fact</b> 70:25 71:8
<b>early</b> 136:23 137:1	<b>enraves</b> 37:2	<b>exception</b> 107:21	
<b>easier</b> 11:11 54:6	<b>enjoyment</b> 118:2	<b>excerpt</b> 55:18 87:10	
<b>Easily</b> 141:10	<b>episode</b> 165:20	<b>excerpts</b> 87:14	
<b>easy</b> 120:1	<b>equipment</b> 36:11	<b>excited</b> 28:7	
<b>ECF</b> 134:10	<b>equivalent</b> 41:20, 21	<b>excluded</b> 101:5	
	<b>era</b> 136:18	<b>exhaustive</b> 91:1	

74:23 75:3 93:11 112:18 121:6 136:8 147:4 170:12 <b>factory</b> 14:5 155:10 <b>failed</b> 86:14 <b>fair</b> 18:6 42:13 45:25 48:10 50:22,23 51:22 64:5,13,16 69:18 81:10 93:8,12 101:3 102:1,7,15 104:25 111:15 114:11,20 124:15, 16 127:24 130:12 139:19,20,23 141:8 159:13 161:1 165:2 <b>fall</b> 33:14 <b>falling</b> 91:7 <b>fame</b> 122:22 <b>familiar</b> 25:11 27:22 28:3,14 31:8,13 32:8 40:22 42:18,21 49:8 82:18 87:15 89:1 95:11 97:3 108:19 115:14 124:17,20,23 125:6 128:1 153:4 154:12,14,16 160:18 167:21 168:4 <b>familiarity</b> 28:5, 11,21 <b>family</b> 26:7 <b>famous</b> 122:21 <b>Farm</b> 33:4 <b>farmer</b> 33:6 <b>farming</b> 15:13 25:11	<b>farther</b> 42:17 <b>fashion</b> 140:10 <b>faster</b> 139:13 <b>father</b> 27:11 <b>Feast</b> 130:23 <b>features</b> 71:15 96:24 97:4,7,8,21 98:1,8 116:14 <b>federal</b> 57:9,14 137:8 160:25 <b>feel</b> 41:5 152:19 <b>feet</b> 39:7 <b>fellow</b> 122:11 <b>felonies</b> 16:10,11 <b>felony</b> 16:3,9 <b>feng</b> 139:1 <b>FIE</b> 65:7,17 66:10, 19 <b>figure</b> 36:8 158:24 <b>file</b> 140:7 <b>filed</b> 6:8 10:25 11:14 12:22 13:22 34:7 <b>find</b> 102:24 139:19 158:21 <b>fine</b> 51:7 <b>fingers</b> 39:19 <b>finish</b> 9:15,16 24:23 26:13 35:21 42:4 44:7 69:3 87:22 <b>finite</b> 12:17 <b>Finland</b> 43:9 <b>Finns</b> 43:5 <b>fire</b> 39:14 57:22,25 58:7 159:4	<b>firearm</b> 17:25 19:2 26:2 27:21,24 31:3 35:10,12 39:24 41:19 47:5, 6,8,12,13,15,21, 24 56:11 63:23 64:3 77:5 85:4 90:3 96:3,6,7,9, 11,16,20 99:9,14, 17,24 100:21,22 101:2 103:14 104:12,13,19,25 105:3,16 106:11, 19,20,22,24 107:4,10,13,16 111:25 112:17 115:23 116:14,19, 23 117:1 1123:13, 16,19,23 124:3,7, 15,17,20 126:20, 23 131:19,23 132:3,8,24 136:3, 14 137:4 138:7 141:6 142:11 149:20 150:9 155:19 157:9,11, 19,23,25 159:3 162:10,12,16,23 163:12,22 <b>firearms</b> 11:20 12:25 16:22 20:10,19 21:24 24:16 25:1 27:22 28:1,4,14,22 29:1 31:20,23 32:7,10, 11,14,17 33:3,6 37:8,9,14,17,23, 24 39:22 45:18 46:5,19,21,25 47:3 50:12 52:11 71:7 77:1 80:8 84:9 88:20 89:5, 11 90:5 92:25 93:3,9,13 96:1 101:17 102:2,3,8, 14 103:12 104:7, 15 107:23 108:19,	25 109:7,18 110:4,25 112:20, 25 113:4,9,15,21 116:8 121:11,20 123:8 125:9,12 128:6,10 132:23 135:2,5,10,17 137:20,24 147:11 148:20 152:15 154:17 156:25 163:1,2 170:13 <b>fired</b> 138:5,7,10 166:17 <b>firing</b> 40:5 48:2 <b>fit</b> 35:12 39:2,7 40:1 47:13,17,20 48:2 76:23 82:9 143:20 145:17 148:8 151:7 152:15,18 158:7, 25 <b>fits</b> 144:16 152:21 <b>fitting</b> 143:18 <b>five-star</b> 118:24 <b>fix</b> 32:24 <b>fixed</b> 125:25 170:9 <b>flash</b> 105:12,13 <b>flat</b> 44:3 <b>flip</b> 41:13 100:14 118:11 <b>flipping</b> 136:13 <b>Florida</b> 65:8,17 <b>FN</b> 145:12 <b>focus</b> 87:14 <b>FOID</b> 16:13,15,18, 21 <b>fold</b> 51:8 91:7 <b>follow</b> 57:10 76:20 127:2 137:11
---	---	--	--

<p><b>forbid</b> 27:12 86:11,13,21</p> <p><b>forged</b> 132:5</p> <p><b>forgot</b> 98:12</p> <p><b>form</b> 11:18 73:13 109:14 141:20 143:4,9 144:19 151:20 152:11 153:10 155:13 156:1</p> <p><b>formal</b> 31:23</p> <p><b>format</b> 61:14</p> <p><b>forums</b> 28:19</p> <p><b>forward</b> 68:18</p> <p><b>found</b> 123:24 134:12</p> <p><b>four-round</b> 99:14</p> <p><b>fourth</b> 73:11</p> <p><b>frame</b> 115:5 148:1, 18 149:23 158:20 159:11,15 161:17</p> <p><b>Frames</b> 149:6</p> <p><b>free</b> 27:16 152:20</p> <p><b>friend</b> 25:24 32:3 43:2</p> <p><b>front</b> 147:19 156:9 163:18 165:6</p> <p><b>full</b> 55:19,20 87:13</p> <p><b>full-size</b> 51:17 52:7,13</p> <p><b>fully</b> 137:14,22 147:11 158:11 159:3,15 169:21 170:13,17</p> <p><b>fun</b> 45:9</p> <p><b>function</b> 132:24 166:20</p> <p><b>functional</b> 122:14</p>	<p><b>functions</b> 89:8</p> <p><b>futures</b> 97:6</p> <hr/> <p style="text-align: center;"><b>G</b></p> <hr/> <p><b>G-A-R-A-N-D</b> 153:13</p> <p><b>G3-10</b> 149:14</p> <p><b>gain</b> 89:8</p> <p><b>Garand</b> 153:5,9, 13,17,23 154:1 166:23 167:16 168:20 169:4,15, 17,23 170:3,6,9, 12,17</p> <p><b>Garands</b> 167:24 168:9</p> <p><b>gas</b> 15:13 153:3,8</p> <p><b>gases</b> 38:19</p> <p><b>gave</b> 39:12</p> <p><b>Gen2</b> 62:4 64:16, 19,24</p> <p><b>general</b> 14:22,23</p> <p><b>generalities</b> 117:3</p> <p><b>generally</b> 5:25 10:1,5 19:1 45:10 46:10,12,24 47:1, 2 57:23 83:17 87:16 117:1 141:6 145:11 147:25 149:3,5 150:13</p> <p><b>generic</b> 26:12 81:21,22</p> <p><b>German</b> 49:3 105:21</p> <p><b>give</b> 15:1 36:7 37:3 54:23 74:4 112:10 159:21</p> <p><b>giving</b> 27:17 55:13</p>	<p><b>glance</b> 105:18,19</p> <p><b>Glock</b> 37:7 46:1 141:15 151:6 156:16,22,23,25 158:2</p> <p><b>Glock-type</b> 141:12</p> <p><b>golf</b> 149:17</p> <p><b>good</b> 54:22 97:12 98:24</p> <p><b>Governor</b> 18:17 108:8</p> <p><b>graduate</b> 14:21</p> <p><b>grandfathered</b> 58:11 60:2</p> <p><b>Grendel</b> 42:19</p> <p><b>Gretchen</b> 6:1</p> <p><b>grip</b> 60:10 98:2,4 105:5 154:21,25 155:7,16</p> <p><b>ground</b> 9:8 168:17 169:12</p> <p><b>grouped</b> 14:2</p> <p><b>grow</b> 31:22</p> <p><b>growth</b> 70:21</p> <p><b>guess</b> 72:15 83:23 92:7 93:21 122:22 130:20 147:6,7,8 167:10</p> <p><b>Guide</b> 87:11,15 92:18</p> <p><b>gun</b> 27:16 30:12, 15,22 31:14 47:5 56:24 65:12 66:8 72:11 88:23 89:1 91:6 120:2,13 134:24 136:17,19 137:17 162:7</p> <p><b>guns</b> 30:9 31:1 57:18,20 74:8,15 137:20 167:20</p>	<p><b>guns.com</b> 29:14, 15</p> <p><b>guys</b> 26:19 27:8 167:19</p> <hr/> <p style="text-align: center;"><b>H</b></p> <hr/> <p><b>hand</b> 20:23 33:10 38:25 41:4 79:18, 20 100:13 116:13 143:24 146:10 149:10,18 150:4, 15 151:9 155:19 165:24 166:8</p> <p><b>handed</b> 36:2,7 48:20</p> <p><b>handful</b> 18:24</p> <p><b>handgun</b> 17:23 18:1,9 19:3,5,16, 23,24 20:7 22:5 35:9,11 36:4 44:19 46:8 49:9 50:20 53:19 61:2 64:20 71:4 80:11, 16,21,22 96:2</p> <p><b>handguns</b> 35:21, 22 42:15 43:15 45:11 46:5 61:8 72:24 80:5</p> <p><b>handing</b> 48:15 55:17 140:23 142:6 143:12 144:2,20 145:2,8 146:2,18 147:17 148:12 149:2 154:23 156:19</p> <p><b>hands</b> 32:9,11</p> <p><b>handy</b> 33:15</p> <p><b>happen</b> 9:18</p> <p><b>happened</b> 64:2</p> <p><b>Harbor</b> 169:11</p>
--	---	--	---

<b>hard</b> 49:4 98:13	155:19 158:12	131:11	<b>includes</b> 12:14,15
<b>harness</b> 32:23	<b>holding</b> 38:25 154:24 166:8	<b>identified</b> 63:16 110:25 111:4,14 113:24 141:3	<b>including</b> 117:10 139:9 156:9,15
<b>hastily</b> 27:6	<b>holds</b> 13:15 64:8	<b>identifies</b> 88:2 149:23	<b>Indiana</b> 135:14
<b>Hazard</b> 122:23	<b>hole</b> 32:24	<b>identify</b> 140:1 149:11 156:16,22 160:6	<b>Indianapolis</b> 116:2
<b>head</b> 10:15 19:20 28:12,17 34:11 85:25 86:20 106:7 120:1,12 161:6 171:2	<b>home</b> 32:4	<b>ii</b> 110:2 122:10 153:18,22 167:13, 14,17 168:14,21 169:8,11	<b>indistinguishable</b> 21:23
<b>headquarters</b> 130:6	<b>homework</b> 82:8	<b>iii</b> 110:15	<b>individual</b> 79:13
<b>hear</b> 8:22,24 13:6 29:6 87:2	<b>hoops</b> 57:10,14	<b>ILCS</b> 97:2,17	<b>industry</b> 134:24
<b>heard</b> 31:3,5 85:6, 15 86:2,24 92:11 136:9	<b>hope</b> 61:19 88:21	<b>Illinois</b> 5:16 6:14 11:113:1 16:24 45:4 60:15 84:14 135:14 137:6 142:20	<b>Indy</b> 116:2
<b>heckler</b> 56:7,10,21 58:11,21 59:10, 17,21,22 60:2,24	<b>host</b> 166:10	<b>imagine</b> 38:18 58:10	<b>inevitably</b> 9:18
<b>heed</b> 76:21	<b>hot</b> 55:2,4	<b>imagining</b> 161:5	<b>infantry</b> 167:17
<b>held</b> 5:17 19:18,19 32:16 40:23 49:11 82:15 118:25 119:6 142:18 143:1 157:6,10 165:10	<b>hour</b> 54:20,21	<b>immediately</b> 12:19 104:6,12,20 106:11,23 107:4	<b>information</b> 30:18 31:19,22 36:3,8 60:15 76:10 116:7 131:14 164:8
<b>Helfrich</b> 6:1 54:20 61:20 74:2 112:11	<b>Howlett</b> 88:2,6,13	<b>imported</b> 65:7,8, 17,19,22,25 66:17,18	<b>insert</b> 79:2 158:20
<b>helped</b> 68:17	<b>Howling</b> 88:22	<b>impact</b> 10:22	<b>inserted</b> 159:3 161:9
<b>Henry</b> 98:21	<b>HS</b> 78:13	<b>impossible</b> 37:18	<b>inside</b> 32:22 43:24 60:9
<b>Hey</b> 68:16	<b>https://www.beretta.com/en-us/arx-100.</b> 41:11	<b>inadvertently</b> 35:18	<b>inspect</b> 139:22
<b>hip</b> 57:22 58:4	<b>hundred</b> 135:25 136:8 155:24	<b>inches</b> 162:5	<b>instance</b> 23:15,24 25:19 37:19 39:10 42:18 44:4 45:25 77:4 92:4 168:25
<b>historical</b> 135:22, 23	<b>hunt</b> 25:17 45:1	<b>include</b> 26:23 47:23 60:17 100:19 106:18	<b>instruction</b> 76:20
<b>History</b> 166:6,9	<b>hunted</b> 25:10	<b>included</b> 89:21 99:23 108:1	<b>instructs</b> 10:2,4
<b>hit</b> 91:9 126:19	<b>Hunter</b> 88:7		<b>insulting</b> 15:16
<b>hold</b> 13:16 79:5 80:12 81:2 143:23 144:15 151:5	<b>hunting</b> 45:3,9 58:3	<b>I</b>	<b>integrate</b> 153:16
			<b>intelligence</b> 15:18
			<b>intend</b> 117:25 123:16
			<b>intended</b> 38:14 39:4,9 71:10
			<b>intending</b> 95:2 107:12

<b>intent</b> 66:24 68:11 75:7,10 99:4	156:9,13	23,24,25	<b>Langley</b> 5:25 6:4, 9,19
<b>interchange</b> 40:19	<hr/> <b>J</b> <hr/>	<b>Kelly</b> 5:23 6:4	<b>Lapua</b> 42:21,22 43:3,4,6,13,16 44:2,4,9,12 45:9
<b>interchangeable</b> 13:18 24:13 35:17,19,20,22 40:15 77:12,20,25 78:14 79:12,23 152:7,10	<b>J(ii)</b> 108:13 109:17 110:1,2,24	<b>Ken</b> 5:19	<b>largely</b> 78:13
<b>interested</b> 86:25	<b>J.B.</b> 108:2,8	<b>key</b> 54:24	<b>larger</b> 152:24
<b>internal</b> 170:9	<b>James</b> 48:25 49:14,20	<b>killed</b> 26:19 27:8	<b>laser</b> 37:2
<b>internal-wise</b> 14:7	<b>Jamie</b> 5:5,18	<b>kind</b> 8:13 10:16 19:16 39:2 51:4 65:12 68:16,17 70:20 78:22 82:5 101:17 103:12 105:11 106:3,6 107:9 120:21 132:4 138:8 145:14 154:23 164:9	<b>law</b> 13:20 17:17 53:21 57:9,14 81:23 108:17 137:6,9 160:25
<b>internet</b> 28:18	<b>January</b> 60:3,13 94:20 107:12 123:15,21 124:5, 6,14 126:22 135:9 161:18 163:25 164:6,20 165:1 170:23,24	<b>Kinder</b> 5:5,18	<b>lawful</b> 8:1
<b>interpose</b> 16:2	<b>Jo</b> 5:5	<b>kinds</b> 27:22 28:3	<b>lawfully</b> 60:13
<b>interpretation</b> 70:24	<b>job</b> 32:16,19,22 33:6 43:24	<b>kit</b> 63:12,13,14,19 64:11,14,18,24	<b>lawsuit</b> 10:24 11:15
<b>interrupt</b> 9:18,19	<b>John</b> 134:24	<b>knock</b> 54:24	<b>leaning</b> 68:17
<b>interruption</b> 134:19	<b>Judge</b> 18:15	<b>knockoffs</b> 127:11	<b>learn</b> 30:16 31:20 66:3 89:6
<b>interviewed</b> 122:10	<b>judgment</b> 6:20 11:14 12:23 13:22 139:5 140:8,11	<b>knowing</b> 157:19 162:4	<b>leave</b> 61:24
<b>introduce</b> 5:20	<b>June</b> 36:1 61:16 66:16 73:7 95:9 99:8 107:20 111:23 134:4 168:3,21	<b>knowledge</b> 28:20 46:11 66:2 89:8 92:3 165:25	<b>led</b> 89:12
<b>invasion</b> 168:3,6	<b>Junie</b> 29:19	<b>Koch</b> 56:7,10,21 58:11,21 59:10, 17,21,22 60:2,24	<b>Lee</b> 165:18 166:2, 5,9
<b>inventory</b> 120:9	<b>Junkie</b> 29:17	<b>Kwame</b> 5:13	<b>left</b> 75:24 158:8
<b>invest</b> 86:12	<hr/> <b>K</b> <hr/>	<hr/> <b>L</b> <hr/>	<b>left-hand</b> 41:12 59:16
<b>invited</b> 139:24 141:5	<b>Kalashnikov</b> 122:9,10,17,18 129:11 169:20	<b>L-WRENCHES</b> 33:24	<b>legal</b> 5:19 12:5 15:17 60:23 101:7 107:7 109:2 137:6,8 142:19,21 143:2 155:14
<b>involved</b> 32:16 168:13,16 169:10	<b>Kel-tec</b> 22:14,15, 18 62:3 63:12 64:10,14,15,19,	<b>labeled</b> 63:12 73:8 90:10 92:14	<b>legales</b> 8:6
<b>involving</b> 166:2		<b>laid</b> 32:8,11	<b>legally</b> 58:18 59:25 60:10 135:13
<b>Irrelevant</b> 20:11		<b>land</b> 77:7	<b>legislation</b> 108:16
<b>issue</b> 35:4,8 53:11,12			<b>Lend-lease</b> 168:16
<b>item</b> 52:24 53:10 150:15			<b>length</b> 57:15 72:8, 9,10,11,12 161:3,
<b>items</b> 139:21 140:2 141:1 148:22 149:2			



<p>6</p> <p><b>lengths</b> 57:16</p> <p><b>letters</b> 85:3,12 100:3</p> <p><b>lever</b> 24:8 100:21 106:20</p> <p><b>liability</b> 77:3</p> <p><b>license</b> 16:23 17:1,7 18:7</p> <p><b>lifetime</b> 27:21</p> <p><b>lightweight</b> 74:16</p> <p><b>likewise</b> 111:24 112:16</p> <p><b>limit</b> 52:21 53:23 61:6 77:3 80:7</p> <p><b>limited</b> 10:3 45:4 53:14</p> <p><b>list</b> 21:11 31:22 36:14 48:5,6 51:15,20 75:16 93:6 97:4,6 108:23,25 109:16, 18 110:1,4 111:17 113:23 121:7 125:9 150:10 151:19 153:25 154:10,17</p> <p><b>listed</b> 50:16 96:24 97:21 98:1 108:19 110:4 112:19 125:10 149:20 150:9,22,24 151:18 154:17</p> <p><b>listing</b> 90:25</p> <p><b>lists</b> 58:15</p> <p><b>litigation</b> 139:23</p> <p><b>live</b> 25:9</p> <p><b>lived</b> 53:17,22 136:22</p>	<p><b>load</b> 39:23 158:11</p> <p><b>Loaded</b> 166:5</p> <p><b>local</b> 120:2,13</p> <p><b>lock</b> 79:4</p> <p><b>Locked</b> 166:4</p> <p><b>locking</b> 82:20</p> <p><b>locks</b> 151:8</p> <p><b>logo</b> 132:23</p> <p><b>long</b> 56:24,25 57:3,18,20 60:24 72:11 74:8,15 114:3 115:12 120:3</p> <p><b>long-range</b> 58:6</p> <p><b>longer</b> 44:5,9 45:10,15 60:8 61:6 65:19,21 66:17 136:4,7</p> <p><b>looked</b> 28:25 29:2, 7 83:21 87:18 128:12 157:15</p> <p><b>lost</b> 68:16</p> <p><b>lot</b> 26:15 27:8 33:25 35:15 82:1 86:12 87:1,20 93:8 118:23 135:21 139:13 167:19</p> <p><b>lots</b> 93:11</p> <p><b>lottery</b> 135:11,12</p> <p><b>low-recoiling</b> 74:16</p> <p><b>lower</b> 41:12 152:15,19,23</p> <p><b>LR</b> 111:5 113:24, 25 114:12,15,18</p> <p><b>lug</b> 82:20</p> <p><b>Luger</b> 72:15,20</p>	<p style="text-align: center;"><b>M</b></p> <hr/> <p><b>M&amp;p</b> 110:10,11 111:5 114:25 115:8</p> <p><b>M-15</b> 111:5 113:24,25 114:12, 15,18</p> <p><b>M-16</b> 26:18 86:14, 19</p> <p><b>M-92</b> 37:19 39:13 40:7,14 45:15 46:1 78:14,16 79:24 80:4 157:2, 6</p> <p><b>M-A-A-G</b> 5:24</p> <p><b>M-LOK</b> 116:14</p> <p><b>M1</b> 142:10,14,16 153:4,9,17 154:1 155:2,8,10,11 158:15,17 166:23 167:16,24 168:9, 20 169:4,15,17,23 170:3,6,9,12,17</p> <p><b>M100</b> 146:14</p> <p><b>M4</b> 115:14</p> <p><b>M4e1</b> 151:11</p> <p><b>M88</b> 146:14</p> <p><b>Ma</b> 39:11</p> <p><b>Maadi</b> 150:6,8</p> <p><b>Maag</b> 5:24 6:6,10 7:1,6,11,15,19,22 8:25 9:5,24 11:18 16:2 17:20 19:9 20:11 21:3 29:21 33:16,20 36:17,20 38:6 39:18 41:5 43:5,9 44:11,21 46:7,9,12 48:18, 25 49:5,23 51:2,5, 7,24 53:4,8,20</p>	<p>54:25 55:3,6,9,14 56:1,12,25 57:2 59:5 62:24 66:4,6 68:13 69:20,23 73:21 74:6 75:11 80:21 81:7 86:8 88:9 92:16 98:16 100:16 101:7,10 106:2 107:7 108:5 109:2,10,14 110:8,13 112:2,4, 7 117:3 122:2 129:25 134:6,8,11 139:1,12,17,20,24 140:4,7,13,21 141:4,22 142:22 143:5,10 144:20 147:12,14,17 148:23 149:2 151:1,3,5,22 152:12 153:13 154:7 155:15 156:3,5,8 159:20, 24 160:3,13 161:2,16 163:15 164:14,21 165:1,6 167:4 168:2 170:23 171:5,16</p> <p><b>Maag's</b> 160:6 162:10,12,16,23 163:1,12</p> <p><b>machine</b> 12:10 63:10 136:17,19 137:17,20 138:4</p> <p><b>made</b> 12:6 21:22 47:8,11,12,13 78:13 83:22,23 114:8,15,18,19 124:3,7 128:6 136:25 146:20</p> <p><b>mag</b> 63:12,14,18 64:10,14,24 105:7,9 125:25</p> <p><b>magazine</b> 11:22 12:3,25 19:7,22,</p>
--	---	---	--

23 20:8 21:20 22:11,23 23:8 30:1,4 35:9,10,12 36:2,3,4,7,9,22,25 37:20,24 42:11 45:19 47:6,9,12, 13,15,17,20 48:2, 9 50:22 51:12,18, 23 52:3,8,12,14, 16,18,20 53:15, 18,23,24 54:11 58:12,13,17 60:4, 9,21 61:1 62:3 64:8,15,20,25 67:4 69:17 70:1, 12 76:6,15,19 77:4,23 78:17 79:7,11,12,23 80:2,10,12,15,16, 25 81:2,4,5,9,10 88:8,24 89:1 99:14 109:21 125:18,25 126:5 141:12,16,17,25 142:3,6,7,10,18, 19 143:1,2,8,12, 13,15,24,25 144:2,12,21,24 145:2,3,6,8,9,13, 14,16,20,24 146:2,3,10,15,19, 21 147:17,22 148:4,7,17 151:6 155:6,9 156:16, 17,23 157:5,6,10, 18,19 158:2,7,12, 20,21 159:2,10,14 160:7,9 170:10  <b>magazines</b> 11:22, 24 12:24 13:18 21:21 23:16 24:13 27:23 28:4 35:20, 22 36:14,18 37:3, 5,9,13,14,17 40:15,19 50:16 54:2 59:22,24 60:21 62:3 77:11,	20 78:7,13,15 140:23,24 141:6 156:9,15 157:14 158:24  <b>magnum</b> 114:2  <b>main</b> 25:20  <b>maintained</b> 16:18 17:7  <b>maintenance</b> 29:2 138:4  <b>major</b> 152:9  <b>make</b> 6:25 29:4 64:15,19,24 78:6, 15,17 79:20,22 82:8 86:3 93:15 98:19 114:4,6 115:4 149:22 150:5 151:10 152:22 154:19 157:10 160:16 163:24  <b>makers</b> 91:7  <b>makes</b> 18:15,17 71:18 92:2 98:22 132:7  <b>Malinois</b> 105:20  <b>man</b> 83:24 135:13 157:22  <b>Manning</b> 88:23  <b>manually</b> 100:21 106:19  <b>manufactured</b> 77:12 128:10 129:18 130:20 132:23 142:16 156:23  <b>manufacturer</b> 30:19 36:24 37:11 40:16 47:8,9,11, 12 48:6 71:10,17, 24 76:25 77:8	81:8,11,12 91:8 116:24 128:4 150:18,20 164:17  <b>manufacturers</b> 35:17 47:19,23 82:4 83:21 89:6 92:20 93:7,8,12 116:25 120:18,19  <b>manufacturers'</b> 30:12,15,23 116:7  <b>manufactures</b> 92:24  <b>manufacturing</b> 14:14,16 145:12  <b>March</b> 17:6,9 132:23  <b>mark</b> 20:23 33:11 41:3 119:14  <b>marked</b> 20:25 21:5 27:20 33:8 34:4 41:1,8 48:12,15, 20 54:7 55:15,18 56:3 87:7,10 96:7 97:13,16 101:22 103:19 115:18 119:17,20 128:16, 20 131:10,13 149:18 151:14 160:10  <b>market</b> 44:25 84:9, 11,15,17 120:25 121:1 155:24  <b>marketing</b> 120:9  <b>marking</b> 96:4 115:20 128:18 149:11 157:15  <b>marking-wise</b> 146:25  <b>markings</b> 35:16 143:13 144:3,21 145:6,9,19,22 146:3,11,13,18	158:3  <b>Marlin</b> 67:5,11,15, 20,22,24 68:4,12 70:3  <b>match</b> 170:17  <b>material</b> 114:20  <b>materials</b> 83:24 115:4  <b>Matt</b> 9:5  <b>matter</b> 5:13 6:5 152:20  <b>Matthew</b> 5:4,12 7:25 34:5,16 171:13  <b>Mauser</b> 82:20  <b>Mcdonald's</b> 124:11,12  <b>meaning</b> 67:12 96:3 99:23 108:8  <b>means</b> 12:8 15:20 53:9 65:17,21 67:5 70:23 89:11 90:1,7,14 91:1,3, 13 92:22,25 98:24 116:19 117:15 118:6,15,19 119:2 120:15 129:8 130:10,19 133:3, 15  <b>meant</b> 56:25 85:10,13 96:10 111:20  <b>measure</b> 79:3  <b>mechanical</b> 139:13  <b>medication</b> 10:17  <b>memory</b> 97:12  <b>mention</b> 29:5 66:15 92:11
--	--	--	---

<p><b>mentioned</b> 12:23                  17:13 20:22 23:2                  27:19 39:1 40:7                  44:10 50:21 68:24                  82:13 93:16                  114:15 158:19                  159:25 165:4                  166:23</p> <p><b>mess</b> 70:9</p> <p><b>messes</b> 161:5</p> <p><b>messing</b> 103:17</p> <p><b>methods</b> 79:8</p> <p><b>metric</b> 41:25</p> <p><b>MFR</b> 116:15</p> <p><b>mic</b> 8:23</p> <p><b>Mid-sentence</b>                  74:12</p> <p><b>middle</b> 56:15,16                  106:15 130:2                  133:8</p> <p><b>mil-spec</b> 117:11</p> <p><b>mile</b> 44:14</p> <p><b>military</b> 15:14 89:7                  170:13,16</p> <p><b>mill</b> 78:21,22 79:1,                  2,6,11,16,19</p> <p><b>millimeters</b> 41:25</p> <p><b>millions</b> 123:1</p> <p><b>mind</b> 9:17 11:11                  33:25 71:23 82:11                  84:16 87:4,23                  111:20 113:3,17,                  20 115:9 138:14</p> <p><b>mine</b> 32:3 43:2                  59:11</p> <p><b>minute</b> 16:1 39:8</p> <p><b>minutes</b> 159:21</p> <p><b>misdemeanor</b>                  16:9</p>	<p><b>misdemeanors</b>                  16:11</p> <p><b>missing</b> 148:6</p> <p><b>misstates</b> 106:2                  109:15</p> <p><b>model</b> 22:8 62:1                  86:3 123:7                  133:18,20 142:11                  144:8 149:13,15,                  20 150:5,16,17                  151:10,11</p> <p><b>models</b> 90:11,14,                  17,23,25 91:3</p> <p><b>modern</b> 119:23</p> <p><b>modify</b> 64:23 80:1                  91:17 92:9</p> <p><b>moment</b> 25:3                  121:17</p> <p><b>money</b> 24:19 28:8                  90:2 93:15 99:3                  118:1 135:21                  162:25</p> <p><b>moral</b> 16:4</p> <p><b>motion</b> 6:20 11:14                  12:22 13:22 139:5                  140:7,10</p> <p><b>motions</b> 6:7</p> <p><b>Mount</b> 14:15</p> <p><b>move</b> 51:17 79:17                  122:6</p> <p><b>movie</b> 48:25</p> <p><b>moving</b> 10:8</p> <p><b>MR762A1</b> 56:10,                  16,21 58:11</p> <p><b>multi</b> 149:17</p> <p><b>multiple</b> 139:25</p>	<hr/> <p><b>N</b></p> <hr/> <p><b>Nam</b> 26:19</p> <p><b>named</b> 49:14</p> <p><b>names</b> 28:23</p> <p><b>naming</b> 43:2</p> <p><b>national</b> 88:6                  135:1</p> <p><b>NATO</b> 37:20 39:14                  45:14 58:21,22,25</p> <p><b>nature</b> 15:11 33:2</p> <p><b>neat</b> 67:14</p> <p><b>necessarily</b> 17:17                  149:7</p> <p><b>needed</b> 58:12 60:4</p> <p><b>nice</b> 44:3</p> <p><b>nine-round</b> 19:23</p> <p><b>nods</b> 10:15 19:20                  28:12,17 34:11                  171:2</p> <p><b>non-                  grandfathered</b>                  143:3</p> <p><b>non-trigger</b>                  155:19</p> <p><b>Normandy</b> 168:4,                  6,8</p> <p><b>notary</b> 5:5</p> <p><b>notch</b> 78:15,16,20                  79:4,7,10</p> <p><b>note</b> 6:3,18,25 7:3                  68:25 140:5,6,11,                  25 148:21,25</p> <p><b>noted</b> 7:1 140:13                  141:4</p> <p><b>NRA</b> 30:2,4 88:17,                  19</p>	<p><b>nuisance</b> 25:6,17</p> <p><b>number</b> 6:13 10:3                  11:8 34:5 47:19                  51:5 55:11 73:6                  77:11 87:5 97:10                  110:6 134:6                  144:6,7,8,9                  149:13,16,20                  150:16</p> <p><b>numbers</b> 22:14                  51:6 71:8 100:13                  125:11</p> <p><b>numeral</b> 109:20                  110:6,7,19,21,24                  125:14,17</p> <hr/> <p style="text-align: center;"><b>O</b></p> <hr/> <p><b>oath</b> 9:9 140:22</p> <p><b>object</b> 9:25 11:18                  56:25 117:3                  140:6,11 159:24</p> <p><b>objection</b> 16:3                  20:11 53:20 59:5                  69:22 86:8 98:16                  101:7,10 107:7                  109:2,12,14 122:2                  140:13 141:1,20                  142:21 143:4,9                  144:19 148:21,24                  151:20 152:11                  153:10 155:13                  156:1 159:20                  161:2 168:2</p> <p><b>objections</b> 7:17                  171:4</p> <p><b>objective</b> 111:24                  112:16 143:7</p> <p><b>objectively</b> 144:16</p> <p><b>objects</b> 10:1,5                  139:18</p> <p><b>obligated</b> 82:25</p>
--	---	---	---

<p><b>obtain</b> 16:15 27:14</p> <p><b>occasions</b> 139:25 162:15,19</p> <p><b>October</b> 5:11</p> <p><b>offer</b> 54:2</p> <p><b>offered</b> 53:15</p> <p><b>offers</b> 59:22 81:9</p> <p><b>Office</b> 82:15</p> <p><b>oftentimes</b> 112:19 121:10</p> <p><b>Oil</b> 15:13</p> <p><b>on-line</b> 6:11</p> <p><b>one's</b> 27:15 54:6 102:9</p> <p><b>online</b> 42:23 130:6</p> <p><b>Oops</b> 33:13</p> <p><b>operated</b> 100:21 101:3 106:19</p> <p><b>operations</b> 44:18, 21</p> <p><b>opinion</b> 113:13,14 121:24,25</p> <p><b>opposed</b> 35:9</p> <p><b>option</b> 74:16</p> <p><b>oranges</b> 39:6</p> <p><b>order</b> 39:2 45:18 57:13 79:23 80:14</p> <p><b>orders</b> 171:15</p> <p><b>ordinarily</b> 58:6</p> <p><b>ordinary</b> 15:18</p> <p><b>origin</b> 127:9</p> <p><b>original</b> 26:5,8,16, 22 27:4 84:3,6 127:12,16 129:11 132:5</p> <p><b>originally</b> 83:9 127:13,20 169:20</p>	<p><b>originated</b> 127:23</p> <p><b>outline</b> 104:24</p> <p><b>outlines</b> 89:14</p> <p><b>outlining</b> 21:11 91:16</p> <p><b>Overbroad</b> 20:11</p> <p><b>overly</b> 81:24,25</p> <p><b>owned</b> 8:20 28:1 58:10 60:2,3,13 67:22 126:20 158:17</p> <p><b>owner</b> 27:21</p> <p><b>Owner's</b> 16:22</p> <p><b>owning</b> 60:14 86:11,13,25</p> <hr/> <p style="text-align: center;"><b>P</b></p> <hr/> <p><b>P-I-C-A</b> 11:3</p> <p><b>p.m.</b> 171:21</p> <p><b>P1</b> 146:6</p> <p><b>P85</b> 70:8,10,12 71:3,7,14 76:4,6, 15,19 77:23 78:7</p> <p><b>P85s</b> 77:19</p> <p><b>P89</b> 70:10,11 71:4, 7,14 76:4,5 77:10, 23 78:7</p> <p><b>P89s</b> 77:19</p> <p><b>pages</b> 55:21 62:12 134:5,17 135:18</p> <p><b>Palmetto</b> 128:1,3, 6,10,12,22 130:5, 20,23 131:15 149:12,21 152:18</p> <p><b>palmettostatearm ory.com.</b> 128:23</p> <p><b>Palmettostatearm ory.com/psak-47</b></p>	<p>131:16</p> <p><b>paper</b> 38:18</p> <p><b>paragraph</b> 21:19, 25 22:9 27:19 28:4 35:1,25 50:2, 13 62:1 65:4 66:15 67:1 69:15 70:8,19 73:11,20 76:1,3,11 78:6,11 88:12,25 89:4 91:6 95:10,14,17, 22,24,25 96:12, 15,23 97:25 98:4 99:7,13 101:2,13, 16 103:7,18,23,24 104:2,5,6,13,15, 19,20 105:4,16,25 106:11,23 107:3, 5,11,16 108:20 111:22,23 112:2, 3,15 117:23,24 121:4</p> <p><b>paragraphs</b> 49:18 96:1</p> <p><b>parameters</b> 112:19,24 113:3, 10,16,20 121:10, 19,25</p> <p><b>part</b> 132:20 153:2 166:8,15,20 170:16</p> <p><b>partially</b> 155:18</p> <p><b>parties</b> 5:21</p> <p><b>parts</b> 71:16 76:23 89:8 125:22 130:3,7,10,13,20 148:6 152:3,8,10 161:12,13 166:16, 21</p> <p><b>party</b> 8:18 140:8</p> <p><b>past</b> 38:14,20 73:12 157:20</p>	<p><b>patent</b> 82:5,13,15, 16,17,24 83:3,7,8, 12,17</p> <p><b>patents</b> 82:15</p> <p><b>pause</b> 22:22 26:14,15</p> <p><b>pay</b> 41:5 57:12 82:25</p> <p><b>paying</b> 82:23</p> <p><b>PC9</b> 70:13 71:21 72:3 75:1,5,8,15 76:7,16,20 77:12, 20,24 78:7</p> <p><b>PCCS</b> 73:13</p> <p><b>PDF</b> 131:14</p> <p><b>PDP</b> 49:8 50:5,9, 12,20,25 51:10, 17,22 52:3,7,11, 13 53:25 54:13</p> <p><b>Pearl</b> 169:11</p> <p><b>pen</b> 38:25</p> <p><b>pending</b> 10:12,13 122:6</p> <p><b>people</b> 6:10 39:6 60:14 85:6 86:2, 17 91:18 92:4,5</p> <p><b>period</b> 162:22</p> <p><b>permits</b> 25:6</p> <p><b>person</b> 15:18 87:13</p> <p><b>personal</b> 34:23 37:8,9 66:2 124:8, 9</p> <p><b>personally</b> 15:23 17:16 21:19 37:13 50:15 78:24 95:19,21 138:5,10 163:21</p> <p><b>peruse</b> 89:5</p>
--	--	---	---

<p><b>Pew</b> 29:9 120:11</p> <p><b>pewpewtactical.com.</b> 119:21</p> <p><b>photo</b> 95:20,21 103:23</p> <p><b>photocopied</b> 48:16,18</p> <p><b>photograph</b> 95:11 99:10 103:14,19 104:8</p> <p><b>phrase</b> 13:23 90:7, 8 91:3,12</p> <p><b>physical</b> 17:3</p> <p><b>physically</b> 37:18 63:9 64:23 79:7 80:1</p> <p><b>PICA</b> 11:3,7,10,13, 17,25 19:21 20:7 24:16,18 25:2 52:12,20 58:17 59:24 60:8,12,23 61:2,5 75:14 80:8 96:5,25 97:21 98:8,11 100:8,9 101:6 106:14 107:5,11,15 121:7 123:15,21 124:2, 13 142:20 143:2</p> <p><b>pick</b> 43:10 95:20, 21</p> <p><b>picked</b> 70:4</p> <p><b>pickup</b> 84:22</p> <p><b>picture</b> 42:9 95:16 101:13 104:5 105:25 131:18</p> <p><b>pictures</b> 101:14, 24 102:2,7,24 103:2,4,6,15 104:18 111:21</p> <p><b>pile</b> 134:13</p> <p><b>pin</b> 40:5</p>	<p><b>ping</b> 170:4</p> <p><b>pins</b> 82:10</p> <p><b>pistol</b> 12:2 13:16 19:6,8 20:1,4 21:21,22 22:1,3, 11,17,19,23 23:20 33:1 35:18 52:15, 17 54:13 59:7 60:9,21 62:2 65:8 66:15 67:4 68:25 69:6,15 70:11 72:3,6,14,17 73:13,17,24 74:1, 8,15,20,23 76:5 78:12 98:2,4 105:5 131:3,5 138:10,15,18 141:16 142:1,13, 16 143:8,16,17, 20,25 144:12,17, 24 145:3,17,25 146:8,16,22 147:3,21 148:2,3 154:20,25 155:7, 16</p> <p><b>pistols</b> 18:8,9,10 23:8 24:13 52:21 70:12 73:4 76:6 77:10 130:3,24 142:20 149:8,9</p> <p><b>piston</b> 153:3,9</p> <p><b>place</b> 64:9 76:23 79:4</p> <p><b>plain</b> 155:11</p> <p><b>plaintiffs</b> 5:3,25 6:7</p> <p><b>plaintiffs'</b> 6:20</p> <p><b>plan</b> 27:18 124:10</p> <p><b>planning</b> 75:14 95:3</p> <p><b>plans</b> 27:14 94:16, 19,22 123:22 126:23 135:10</p>	<p><b>plastic</b> 114:9,16</p> <p><b>platform</b> 13:15 24:20 25:1,5,21, 23 26:22 43:14</p> <p><b>PMR-30</b> 22:15,19</p> <p><b>point</b> 6:24 39:18 65:25 111:24 162:4</p> <p><b>Pointe</b> 5:18</p> <p><b>pointed</b> 62:18</p> <p><b>pointing</b> 34:14</p> <p><b>points</b> 9:25</p> <p><b>Police</b> 60:15</p> <p><b>polyethylene</b> 114:17,19 115:3</p> <p><b>popular</b> 94:11 123:8</p> <p><b>popularity</b> 93:13</p> <p><b>population</b> 25:18</p> <p><b>portion</b> 13:9 23:11 46:15 59:3 63:4 77:15 80:19 81:17 102:4,16,21 121:22 134:22 142:23 153:11 154:4 159:16 161:22 167:5 170:19</p> <p><b>position</b> 7:1</p> <p><b>possess</b> 11:25</p> <p><b>possessed</b> 96:6, 20</p> <p><b>possession</b> 13:14 143:3</p> <p><b>possibly</b> 30:11 139:9</p> <p><b>potentially</b> 6:22 93:22 140:10 141:25 142:3</p>	<p>143:20 147:15 149:8 152:9</p> <p><b>powder</b> 12:16</p> <p><b>power</b> 79:2</p> <p><b>precise</b> 58:7</p> <p><b>Precision</b> 151:13</p> <p><b>predecessors</b> 141:5</p> <p><b>prefer</b> 43:21,23</p> <p><b>Preferably</b> 45:20</p> <p><b>preferred</b> 91:16</p> <p><b>prepare</b> 21:16</p> <p><b>prepared</b> 107:20</p> <p><b>preparing</b> 126:16</p> <p><b>present</b> 5:20 124:6 126:12,13, 19</p> <p><b>presently</b> 19:9,11</p> <p><b>pretty</b> 10:8 38:11 43:14 98:24</p> <p><b>previous</b> 103:10, 11</p> <p><b>prices</b> 128:5</p> <p><b>primer</b> 40:6</p> <p><b>print</b> 62:25 90:25</p> <p><b>printout</b> 41:9 48:22 54:8 115:21 119:21</p> <p><b>prior</b> 19:9,15 60:13 98:7 107:11 123:15,21 124:4,5 126:15,22 135:9 141:2 168:13,17, 21 171:4</p> <p><b>Pritzker</b> 108:8</p> <p><b>probe</b> 15:22</p> <p><b>probing</b> 10:16</p>
--	--	---	---



<p><b>problem</b> 14:1 32:24 103:17</p> <p><b>proceeding</b> 7:14</p> <p><b>produced</b> 8:1 123:2 139:22</p> <p><b>product</b> 30:22 132:11</p> <p><b>product-improved</b> 70:11 76:5</p> <p><b>production</b> 71:23 75:2 136:1,4,6</p> <p><b>products</b> 30:16 32:17 89:6 163:1</p> <p><b>Produkt</b> 78:13</p> <p><b>program</b> 29:2 166:9 168:16</p> <p><b>prohibited</b> 96:24 155:7</p> <p><b>prohibiting</b> 154:19</p> <p><b>project</b> 38:22</p> <p><b>pronounce</b> 43:5</p> <p><b>pronounced</b> 42:24</p> <p><b>pronunciation</b> 43:12</p> <p><b>properly</b> 84:10 109:18 111:1,19 115:1 125:13 126:6</p> <p><b>Protecting</b> 11:1</p> <p><b>proud</b> 133:18</p> <p><b>provide</b> 118:2</p> <p><b>provided</b> 49:19</p> <p><b>provision</b> 97:5</p> <p><b>PS</b> 131:18</p> <p><b>PSA</b> 133:8</p> <p><b>public</b> 5:5 11:1 17:23 18:1,3,14, 20 19:2</p>	<p><b>publication</b> 30:2 88:17,24</p> <p><b>published</b> 32:13</p> <p><b>pull</b> 40:5 101:18 103:13,16</p> <p><b>pulled</b> 13:19</p> <p><b>pump</b> 102:9,10,12, 13 106:20</p> <p><b>pump-action</b> 102:3,8,15 104:7, 13 105:16 106:10, 24 107:22</p> <p><b>puppy</b> 43:3</p> <p><b>purchase</b> 13:1 24:17 25:2,4 31:22 52:3,4,6,9, 11,13,15,17 53:18,24 58:17 59:25 60:1 61:1 64:10,13 66:24 68:11 75:7 81:9 94:16,19,24 95:3 107:13,16 123:22 126:23 127:3 137:12 157:18 163:24 164:1,6, 11,13 170:24</p> <p><b>purchased</b> 45:7 84:13,14 162:18 163:21 164:21 165:1 170:23</p> <p><b>purchasing</b> 27:18 47:9 164:20,25</p> <p><b>purpose</b> 24:22 64:3</p> <p><b>purposes</b> 17:15 60:22 148:7</p> <p><b>pursuant</b> 21:7</p> <p><b>Pursuatnt</b> 21:6</p> <p><b>push</b> 84:2</p> <p><b>put</b> 8:17 18:16,17</p>	<p>28:8 38:7,9,18 39:6,13 54:15 55:5,10 61:22 76:22 77:2 79:1,2 87:1 131:8 132:17 138:4 148:4 156:8 159:21 165:17,21 166:15 169:12</p> <p><b>putting</b> 38:25 64:8</p> <hr/> <p style="text-align: center;"><b>Q</b></p> <hr/> <p><b>quality</b> 68:8 132:24</p> <p><b>quarter</b> 44:14</p> <p><b>question</b> 9:22,24 10:12,13,17 13:14 16:3 17:10 20:18 24:23 33:25 46:14 60:23 81:16 87:5, 22 96:16 102:6 105:22 108:3,6 109:15 117:4 122:4,5 134:21 141:21</p> <p><b>questions</b> 7:20 8:4 9:15 15:24 139:10,12 140:21 156:7,10 171:3</p> <p><b>quick</b> 156:4</p> <p><b>quickly</b> 10:8 91:7</p> <p><b>quote</b> 96:7 112:24, 25</p> <hr/> <p style="text-align: center;"><b>R</b></p> <hr/> <p><b>raccoons</b> 32:22</p> <p><b>rail</b> 116:15</p> <p><b>range</b> 28:6,10 44:5,9,16 45:3,10, 15 77:11 92:4</p> <p><b>Raoul</b> 5:14,23</p>	<p><b>reaching</b> 44:1</p> <p><b>read</b> 13:4,10 23:10,12 30:22,25 35:7 46:16 49:15, 19,23,25 59:2,4 63:2,5 77:14,16 80:18,20 81:16,18 90:18 97:8 102:5, 17,22 107:21 108:2,7 112:7 121:23 123:4 131:2 134:21,23 142:24 149:11 153:12 154:5 159:17 160:8 161:23 167:6 170:20 171:6</p> <p><b>reading</b> 95:10 107:24 153:25 155:11</p> <p><b>real</b> 45:5 156:4</p> <p><b>realize</b> 9:3</p> <p><b>realized</b> 122:11</p> <p><b>reason</b> 11:13 25:20 40:15 50:16 71:13 79:16 96:4, 15,20 100:2 105:3 111:9,11 155:3 170:16</p> <p><b>reasonable</b> 128:5</p> <p><b>reasons</b> 27:9 100:5 105:6 115:7 125:23 126:2 132:2</p> <p><b>rebutting</b> 69:24</p> <p><b>recall</b> 22:1 50:1 86:1 163:16</p> <p><b>recalling</b> 49:25</p> <p><b>receive</b> 30:4</p> <p><b>received</b> 7:14 17:2,5 31:23 32:2</p>
--	--	--	---

<p><b>receiver</b> 115:5                  150:5 151:9,18                  152:14,16,19                  163:21</p> <p><b>receivers</b> 132:22,                  25 151:23 152:24                  156:10 163:16,18                  164:5,9,15,18,20,                  22,25 165:1                  170:22</p> <p><b>recognize</b> 21:8                  33:21 34:1 115:23                  141:6,11 142:7,10                  145:13 146:24                  147:4,18,24 149:3                  153:2 160:22                  165:8,13</p> <p><b>recognized</b> 147:1</p> <p><b>recognizing</b> 139:6</p> <p><b>recoil</b> 43:19,22</p> <p><b>record</b> 5:10 6:3,                  13,18,25 7:2 9:17                  13:10 15:1 16:1                  17:11 23:12 31:7                  34:4,12 38:24                  46:16 59:4 63:5                  75:19,22 77:16                  80:20 81:18                  100:17 102:5,17,                  22 119:10,13                  121:23 133:24                  134:2,23 140:5,                  12,14,16,19 141:1                  142:24 151:1                  153:12 154:5                  159:17 161:23                  167:6 170:20                  171:10,14</p> <p><b>records</b> 148:22</p> <p><b>red</b> 88:4</p> <p><b>refer</b> 11:2 41:17                  85:6 113:17                  118:17</p>	<p><b>reference</b> 12:6,11                  49:2 50:9 55:8                  72:15 90:5 96:1                  129:15 130:12,13                  136:18,20 154:19</p> <p><b>referenced</b> 65:5                  84:8</p> <p><b>referencing</b> 22:6                  54:16 120:17</p> <p><b>referring</b> 21:24                  26:9,17 60:20                  69:20,24 82:14                  83:2,8,18 85:20,                  22 86:17 89:19                  91:4 93:17 96:5                  97:2,4,22 103:18,                  22 114:12 121:7                  129:9 135:2</p> <p><b>refers</b> 29:20 42:1                  48:1 56:17 167:11</p> <p><b>reflect</b> 31:7 34:12                  38:24 171:10</p> <p><b>reflection</b> 34:22                  93:13</p> <p><b>refocus</b> 82:21</p> <p><b>refuse</b> 20:13</p> <p><b>refusing</b> 20:14</p> <p><b>register</b> 12:19</p> <p><b>registered</b> 15:9                  161:16</p> <p><b>registration</b> 12:11</p> <p><b>regulated</b> 160:25</p> <p><b>regulation</b> 57:15</p> <p><b>regulations</b> 57:16                  160:18,22 161:11</p> <p><b>related</b> 6:19 7:17                  12:24 13:23 33:6                  82:2</p> <p><b>relates</b> 10:24</p>	<p><b>relating</b> 11:15</p> <p><b>relied</b> 28:21 78:5</p> <p><b>reload</b> 170:5</p> <p><b>rely</b> 29:25 30:18                  31:19</p> <p><b>remain</b> 123:7</p> <p><b>remember</b> 11:6                  16:16 22:7 38:4,5,                  6,8 49:12,16                  63:15 64:6 68:15                  72:8 87:22 97:9                  98:13 107:24                  115:12,15 121:15                  122:16 125:24                  126:7 138:11                  154:10,15 162:21                  164:2,8,19,23,25                  165:18 167:12                  169:3,6</p> <p><b>remind</b> 9:19</p> <p><b>remove</b> 152:19</p> <p><b>repeat</b> 13:3 46:14                  102:6 108:3</p> <p><b>Repeating</b> 98:22</p> <p><b>rephrase</b> 124:4                  152:12</p> <p><b>replace</b> 58:12                  60:4,11 61:1</p> <p><b>replaced</b> 170:13,                  17</p> <p><b>reporter</b> 5:6 6:15                  9:12,21 13:10                  16:22 23:12 46:16                  55:12 59:4 63:5                  77:16 80:20 81:18                  87:6 102:5,17,22                  121:23 134:23                  142:24 153:12                  154:5 159:17                  161:23 167:6                  170:20 171:15</p>	<p><b>reporter's</b> 5:18</p> <p><b>represent</b> 5:21                  41:9 48:21 97:16                  115:21 116:25                  119:20 128:21                  131:14 142:9                  155:1</p> <p><b>representation</b>                  42:10</p> <p><b>representing</b>                  17:16</p> <p><b>requested</b> 13:9                  23:11 46:15 59:3                  63:4 77:15 80:19                  81:17 102:4,16,21                  121:22 134:22                  142:23 153:11                  154:4 159:16                  161:22 167:5                  170:19</p> <p><b>required</b> 32:2</p> <p><b>requirement</b> 60:25</p> <p><b>reservation</b> 139:3</p> <p><b>reserving</b> 6:21                  7:17</p> <p><b>resources</b> 12:17</p> <p><b>respect</b> 7:17</p> <p><b>responds</b> 8:23</p> <p><b>response</b> 140:2</p> <p><b>rest</b> 14:7</p> <p><b>results</b> 79:18</p> <p><b>resurgence</b> 73:12</p> <p><b>review</b> 34:19                  110:1,4,22 125:9,                  12 126:11,15</p> <p><b>reviewed</b> 50:8</p> <p><b>reviewing</b> 49:12                  109:16</p> <p><b>reviews</b> 30:22</p>
---	--	--	---

<p>118:24  <b>revolutionized</b>                  134:24  <b>revolvers</b> 18:10  <b>revolving</b> 100:23                  106:21 107:1  <b>Rick</b> 13:5  <b>rid</b> 32:24  <b>rifle</b> 12:3 18:3,10                  21:20,21 22:4,5,                  10,20,23 23:17,25                  24:2,3 35:9,11                  36:5 40:10 43:13,                  18 45:7,8 50:17,                  22 56:21,23,24                  57:10 59:1 63:9                  64:16,20,24 65:13                  67:6,15,20,22                  68:12 69:17 70:1,                  3,13 72:7,9,12,18                  74:17 76:7,16                  81:1,5,7,8,10,12,                  20 82:2 83:8,9                  85:14 86:4,6,18                  88:6 89:9 90:11,                  14,23,25 91:3                  93:19,23,25 94:4,                  12,14,17,20,24                  95:3,11 96:3                  98:15,19,24,25                  99:5 103:25                  104:8,17,20                  105:17 106:1,7,8                  114:3 115:5                  118:1,6,9,18,19,                  20 119:4,6                  122:13,22 124:23                  127:16 129:9,10                  131:21 132:16                  133:18 136:25                  141:16 142:4,13,                  14 143:3,8,16,17,                  20,25 144:12,17,                  24 145:3,17,25                  146:8,16,22</p>	<p>147:3,6,21 148:2,                  14 154:3,20                  155:5,8 160:13,                  14,16,23 161:8,                  10,17,21,24 162:4                  169:21,23 170:6  <b>rifle/pistol</b> 11:23                  130:7  <b>Rifleman</b> 29:24                  30:4 75:25 88:16  <b>rifles</b> 11:22 22:10                  23:7,16,21 24:4,                  10,12 35:21,23                  42:15 45:10                  46:22,24 50:15,18                  57:5,7,15,17,18,                  23 58:20,21 62:4                  67:11,24 73:1,4                  74:17,20,23 77:12                  85:20,21 90:16                  91:17,18,21                  104:8,16 107:22                  110:10,11 111:6,                  14 114:19,25                  115:8 117:10                  120:20,21 122:12                  130:2 149:6,7  <b>right-hand</b> 56:12                  61:7  <b>rights</b> 7:17 139:3  <b>rigid</b> 79:17  <b>ripped</b> 82:23  <b>Rob</b> 88:22  <b>Roman</b> 108:13,24                  109:20 110:6,7,                  19,21,24 125:2,3,                  10,11,14,17  <b>room</b> 9:13 75:11,                  12  <b>roots</b> 85:2  <b>roughly</b> 38:1,2</p>	<p><b>round</b> 35:9,10                  39:14 48:9 56:18  <b>rounds</b> 12:1                  13:16,17 19:14,                  15,18,19 20:8                  47:16,20 48:1,5                  51:15,20,23 52:3,                  8,21 58:15 80:11,                  16 81:1,5 142:19                  143:1 158:7,12  <b>rows</b> 25:13,15  <b>royalties</b> 82:23,25  <b>Ruger</b> 22:2,7 68:5                  70:8,10,13 71:21                  72:3 75:1,5,7,15                  76:4,6,14,16,19                  77:18,20,21,23                  78:7 117:10  <b>Ruger's</b> 77:9  <b>rule</b> 7:9  <b>rules</b> 9:8  <b>run</b> 41:25 55:4  <b>running</b> 55:7                  76:24  <b>rushed</b> 27:6  <b>Russia</b> 127:10,13  <b>Russian</b> 127:17,                  19  <b>Russians</b> 153:15</p> <hr/> <p style="text-align: center;"><b>S</b></p> <hr/> <p><b>S&amp;w</b> 69:9  <b>Sabots</b> 12:16  <b>sale</b> 129:18                  142:20 143:2                  164:12  <b>Savage</b> 117:10  <b>schedules</b> 29:4</p>	<p><b>school</b> 29:3  <b>science</b> 14:19,22  <b>screenshot</b>                  119:22  <b>screenshots</b> 51:1                  128:22  <b>screws</b> 63:10                  82:10  <b>script</b> 128:24  <b>scroll</b> 33:25  <b>season</b> 45:8  <b>section</b> 73:23                  97:21 100:13,18                  106:15 107:23                  110:1  <b>seek</b> 6:22 139:8  <b>sees</b> 88:11  <b>selected</b> 107:25                  111:18  <b>selections</b> 55:23  <b>selling</b> 32:17                  132:4  <b>sells</b> 54:10  <b>semi-automatic</b>                  24:10,12 73:12                  99:19 101:19                  102:20 103:13                  154:20 155:5,8                  169:23 170:6  <b>sense</b> 17:18 85:18                  92:2 135:21  <b>sentence</b> 35:4                  65:6 73:15,23                  74:11,14 88:25                  89:11,20 90:1,4,                  23 91:3,5,13                  116:19 117:8,15,                  22 118:6 119:2                  120:16,24 121:14                  133:4</p>
--	--	--	--

<p><b>sentences</b> 120:7 130:22</p> <p><b>September</b> 7:9 15:3</p> <p><b>serial</b> 77:11 144:6, 7</p> <p><b>series</b> 67:3 68:25 69:5,9 78:12,14 79:24 80:5</p> <p><b>served</b> 7:4,9 15:14 140:3</p> <p><b>service</b> 76:14,18 77:9</p> <p><b>servicing</b> 60:17</p> <p><b>set</b> 42:12,13 95:8 113:16</p> <p><b>settled</b> 117:10</p> <p><b>setup</b> 67:14 79:17</p> <p><b>Seventh</b> 139:7</p> <p><b>SGRO</b> 8:22 13:5 68:16,21</p> <p><b>shadow</b> 62:2 104:23</p> <p><b>shape</b> 104:25 105:3</p> <p><b>share</b> 11:24 14:4,5 22:23 23:14 26:6 27:3 40:18 71:15, 16 125:22</p> <p><b>shares</b> 12:2 23:19 116:20 127:22 129:10</p> <p><b>shelf</b> 120:3,14</p> <p><b>shell</b> 143:18</p> <p><b>shells</b> 18:16,17,19</p> <p><b>Shepherd</b> 105:21</p> <p><b>shinier</b> 160:3</p> <p><b>shoot</b> 28:8,9 58:3 94:5,6</p>	<p><b>Shooter's</b> 31:5,8, 9,11 55:19,21 56:4 59:9,15 87:11,15,18 92:18</p> <p><b>shooting</b> 28:6,10</p> <p><b>shop</b> 66:8 120:2, 13</p> <p><b>short</b> 57:2 59:12 75:20 119:8,11 133:22,25 140:17</p> <p><b>short-barreled</b> 57:5,7,10,17 160:23 161:8,10, 17,21,24 162:3</p> <p><b>shorter</b> 72:9</p> <p><b>shorthand</b> 5:5,6</p> <p><b>shot</b> 18:19 43:25 118:25 119:4</p> <p><b>shotgun</b> 18:14,16, 17,18,19 35:11 45:7 100:22 106:21 107:1 141:17 143:16,17 144:13,17,25 145:4,17,25 146:8,16,22 147:3,21 148:2</p> <p><b>shotguns</b> 18:18 46:19 47:2</p> <p><b>shoulder</b> 58:1,8</p> <p><b>shoulder-fired</b> 46:25 47:3 57:20</p> <p><b>show</b> 28:7 66:4 102:2</p> <p><b>show's</b> 166:4</p> <p><b>showed</b> 163:15</p> <p><b>showing</b> 31:7 87:9 97:15 119:19 131:12</p> <p><b>shown</b> 62:21 95:11 103:14</p>	<p>104:8 107:23 116:4 128:20 156:15 158:19</p> <p><b>shroud</b> 155:17</p> <p><b>shui</b> 139:1</p> <p><b>sic</b> 21:6 122:17 166:5</p> <p><b>side</b> 41:23 42:12, 13 61:7 95:8 146:5</p> <p><b>side-by-side</b> 165:20</p> <p><b>SIG</b> 117:10</p> <p><b>sights</b> 14:6</p> <p><b>signature</b> 5:7 21:13 34:9,10,14 171:7,9,11,18</p> <p><b>signed</b> 34:20 108:2,8,17 125:7</p> <p><b>silhouette</b> 104:21, 22 105:18 116:20, 21 132:6</p> <p><b>similar</b> 7:21,22 65:7 104:21 105:4,7,9,10,13, 24 106:1 116:21 117:18,19</p> <p><b>simple</b> 8:17 87:14</p> <p><b>simply</b> 146:24</p> <p><b>simulate</b> 39:1</p> <p><b>single</b> 78:15,16 79:20</p> <p><b>sip</b> 54:24</p> <p><b>sir</b> 10:20 20:3 61:11 67:19</p> <p><b>sit</b> 111:8,13 121:18 159:4 161:19 164:24 166:19</p>	<p><b>situation</b> 10:5 48:8</p> <p><b>size</b> 38:19,21 153:8</p> <p><b>sized</b> 78:25</p> <p><b>skills</b> 79:14</p> <p><b>Skipped</b> 56:1</p> <p><b>SKS</b> 14:3 109:21 112:21 121:12,21 125:17,20,24 126:4,10,20,23 127:3,5,9,12,16, 22 129:15,17,20 146:23 147:5</p> <p><b>skunks</b> 32:25 33:1</p> <p><b>slept</b> 64:4</p> <p><b>slide</b> 100:22 106:20</p> <p><b>slowly</b> 26:15</p> <p><b>small</b> 91:6 108:24</p> <p><b>Smith</b> 12:14 18:16 20:5 37:6 67:3 68:25 69:5 110:10 111:5 114:25 115:8</p> <p><b>smooth</b> 25:21</p> <p><b>Snap-on</b> 12:9</p> <p><b>snaps</b> 148:13</p> <p><b>sniper</b> 44:18</p> <p><b>snipers</b> 44:22</p> <p><b>soft</b> 9:5</p> <p><b>sold</b> 50:19 53:15 67:11,25 96:6,20</p> <p><b>soldiers</b> 122:11 167:23,24 168:20</p> <p><b>somebody's</b> 82:24</p> <p><b>Sort</b> 31:21 71:5 85:2</p>
--	---	---	--

<p><b>sound</b> 68:17 69:13 83:15 98:23</p> <p><b>source</b> 29:25 76:10</p> <p><b>sources</b> 28:20</p> <p><b>South</b> 145:12</p> <p><b>Southern</b> 5:15 6:14</p> <p><b>Soviet</b> 132:21,22</p> <p><b>SP5</b> 59:17,21 60:3, 24</p> <p><b>speak</b> 8:25 77:18</p> <p><b>speaking</b> 10:1,5 19:1 46:10,12,25 57:23 141:6</p> <p><b>special</b> 44:18,21</p> <p><b>specific</b> 6:4,8 12:8,13,23 33:2,5 47:13,16 77:11 80:10,15 81:1,4 82:16,17 83:3,8 93:3 161:1</p> <p><b>specifically</b> 97:2 101:5 165:23</p> <p><b>specifications</b> 47:24</p> <p><b>speculating</b> 159:13,19</p> <p><b>speculation</b> 29:21 167:4</p> <p><b>speeding</b> 16:5,7</p> <p><b>spend</b> 90:2 117:25</p> <p><b>spent</b> 87:20 162:25 163:11</p> <p><b>SPM</b> 34:6</p> <p><b>spoken</b> 9:5</p> <p><b>Sports</b> 150:21 151:2,3 152:15 162:9 164:14</p>	<p><b>spots</b> 139:14</p> <p><b>Springfield</b> 78:11 79:24 80:4 82:19</p> <p><b>stamp</b> 134:10</p> <p><b>stamped</b> 132:22 156:24</p> <p><b>stamps</b> 37:2</p> <p><b>stand</b> 93:18 94:9 122:15 136:16</p> <p><b>standard</b> 130:24</p> <p><b>standard-issue</b> 167:16</p> <p><b>standards</b> 111:25 112:17</p> <p><b>standing</b> 148:24</p> <p><b>standpoint</b> 14:5 139:13</p> <p><b>stands</b> 122:18 137:18</p> <p><b>staple</b> 33:13</p> <p><b>start</b> 8:5 11:22 62:17 109:25</p> <p><b>started</b> 139:17 169:8</p> <p><b>starts</b> 35:4 73:24</p> <p><b>state</b> 5:23 6:2 17:14,18 41:6 45:4 53:16,23 60:15 109:13 128:1,3,6,10,12, 22 130:5,23 131:15 149:12 152:18</p> <p><b>stated</b> 24:15</p> <p><b>statement</b> 21:6 33:11 66:16 77:19,22 123:4,9 139:20</p> <p><b>statements</b> 77:3</p>	<p><b>states</b> 5:15 53:14 84:15 155:24 167:17 169:10</p> <p><b>status</b> 66:10</p> <p><b>statute</b> 19:9,15 46:10 98:1 100:12 108:8,9 109:10, 15,17 113:23 124:25 125:7 155:12</p> <p><b>statutory</b> 97:4</p> <p><b>stay</b> 148:7</p> <p><b>stick</b> 11:10,12</p> <p><b>sticker</b> 21:2,3,4 33:16 41:4 48:16, 18 55:5,11,13 128:19</p> <p><b>Stimpy</b> 55:6,7</p> <p><b>stipulate</b> 161:16</p> <p><b>STIPULATED</b> 5:2</p> <p><b>stock</b> 87:1 98:6 148:12 154:23,24 155:1,7,10,17,22, 23 160:15</p> <p><b>stole</b> 82:19</p> <p><b>Stoner</b> 26:17 83:10</p> <p><b>Stoner's</b> 84:25</p> <p><b>stop</b> 110:14</p> <p><b>stopped</b> 110:16, 17,18,19</p> <p><b>stops</b> 72:8 110:23</p> <p><b>store</b> 47:5</p> <p><b>stores</b> 31:14</p> <p><b>stormed</b> 168:7,8</p> <p><b>story</b> 43:12</p> <p><b>straight</b> 98:5 101:18 103:13,16</p>	<p><b>strike</b> 40:6 113:20</p> <p><b>struck</b> 24:16 107:15</p> <p><b>structure</b> 83:24</p> <p><b>stuff</b> 26:7 28:7 153:15</p> <p><b>style</b> 116:14,19,23 117:1</p> <p><b>SUB2000</b> 62:4 64:16,19,24</p> <p><b>Subject</b> 11:19 171:4</p> <p><b>submit</b> 60:14</p> <p><b>subpart</b> 108:12, 13,24 110:15</p> <p><b>subscribe</b> 88:16</p> <p><b>subsection</b> 109:17 125:2</p> <p><b>subsequent</b> 124:6</p> <p><b>subsequently</b> 170:12</p> <p><b>subsidiary</b> 68:4</p> <p><b>Substantively</b> 153:7</p> <p><b>suited</b> 43:18</p> <p><b>summary</b> 6:20 11:14 12:22 13:22 139:5 140:7,11</p> <p><b>supplement</b> 140:10</p> <p><b>supplemental</b> 49:20</p> <p><b>suppose</b> 57:19</p> <p><b>supposed</b> 12:2</p> <p><b>suppressor</b> 105:12,13</p> <p><b>surprise</b> 76:13</p>
---	--	--	--



<p><b>surprised</b> 132:4  <b>swear</b> 6:16  <b>swept</b> 82:1  <b>switch</b> 156:4  <b>switched</b> 19:22  <b>sworn</b> 6:17 8:1                  33:11 66:16  <b>symmetrical</b>                  138:14  <b>system</b> 23:19                  41:25  <b>systems</b> 9:2 23:14</p> <hr/> <p style="text-align: center;"><b>T</b></p> <hr/> <p><b>table</b> 31:16 152:6                  156:13 158:24                  163:19  <b>Tactical</b> 29:9                  120:11  <b>tag</b> 152:19  <b>taking</b> 6:19 9:12                  69:23 123:15,21  <b>talk</b> 26:15 122:7  <b>talked</b> 24:6 113:5,                  12  <b>talking</b> 12:8,9,10                  33:24 69:15 73:16                  75:24 85:19 86:4,                  7 88:19,20 92:4                  101:1 117:2  <b>Tanfoglio</b> 65:7,12,                  18,24  <b>target</b> 44:20 91:8  <b>Taurus</b> 18:15  <b>taxes</b> 41:6  <b>technically</b> 7:7  <b>technological</b> 9:7</p>	<p><b>technology</b>                  116:15  <b>Ten</b> 128:15  <b>tend</b> 57:20  <b>term</b> 15:17 81:21,                  22 86:2,7,24  <b>terms</b> 17:14 25:22                  127:12 129:5  <b>terrific</b> 117:6,8,24  <b>test</b> 159:7,22  <b>tested</b> 159:10  <b>testified</b> 96:12                  116:6  <b>testify</b> 10:18,22                  109:13  <b>testifying</b> 159:23  <b>testimony</b> 34:23                  35:14 70:16 78:18                  84:1 86:3 96:12                  98:3,7,10 106:2                  112:22 113:7                  121:16 143:19  <b>TGM-9</b> 150:17  <b>thing</b> 27:6 55:19                  82:11 114:8,14                  126:1 162:20  <b>things</b> 14:2 57:4                  82:1,3,5 83:1  <b>thinking</b> 121:15  <b>Thirty-seven</b>                  110:9  <b>Thomas</b> 5:24 49:4  <b>thought</b> 26:20                  31:2 49:3 86:20,                  23 128:9  <b>thousand</b> 44:20                  163:4  <b>tickets</b> 16:5,7</p>	<p><b>time</b> 5:11 8:10,23                  29:3 33:16 47:10                  75:19,22 79:18                  82:4 83:22 84:2                  86:12 87:21                  119:10,13 127:3                  133:24 134:2                  139:8,11 140:16,                  19 162:22 164:22,                  24 171:4,14  <b>times</b> 18:24 86:9                  122:3 141:5                  162:17  <b>titled</b> 21:6 34:5  <b>today</b> 10:18 11:13                  15:19 52:9 75:11,                  12 84:9,11,13,18,                  23 98:19,22                  107:15,18,19                  111:9,13 135:19                  143:24 144:11,15                  159:5 161:10,20                  164:24 166:19  <b>Today's</b> 5:11  <b>told</b> 68:1  <b>tolerances</b> 38:14  <b>Tom</b> 21:2 33:19                  41:4 48:17 50:11                  55:13 109:12                  128:19 147:10  <b>Tomcat</b> 162:21  <b>Tommy</b> 167:20  <b>tomorrow</b> 7:6                  140:4  <b>tool</b> 79:2  <b>tooling</b> 11:21 12:7                  71:22  <b>tools</b> 12:9,10                  33:23  <b>top</b> 34:6 49:7 51:8                  62:12 73:6 101:23</p>	<p>102:10 103:19,23,                  24 128:24 129:14                  130:8  <b>topics</b> 12:21  <b>topsy-turvy</b> 51:4  <b>tore</b> 165:17,21  <b>tornado</b> 126:19  <b>touching</b> 44:1  <b>tough</b> 43:20  <b>towel</b> 38:18  <b>trade</b> 142:20 143:3  <b>traditional</b> 155:23  <b>Traditionally</b>                  132:15  <b>train</b> 14:8  <b>training</b> 31:24                  32:1,2,3 33:5  <b>trainings</b> 32:5  <b>trajectory</b> 44:3                  84:25  <b>transcribed</b> 5:6  <b>Transcript</b> 171:15  <b>transfer</b> 12:1  <b>transitioning</b>                  132:21  <b>treasurers</b> 135:1  <b>triggers</b> 14:6  <b>troops</b> 168:6  <b>true</b> 51:25  <b>trust</b> 130:8  <b>Truth</b> 30:9  <b>truthfully</b> 10:18,22  <b>tube</b> 38:18  <b>turn</b> 27:15  <b>Turning</b> 130:15                  158:2</p>
---	--	---	--

<p><b>turpitude</b> 16:4</p> <p><b>type</b> 14:17 19:5 24:2,4 71:3 86:6 124:23 125:21 126:5</p> <p><b>types</b> 93:3</p> <p><b>typewriting</b> 5:7</p> <p><b>typically</b> 114:11</p> <p><b>typos</b> 171:6,8</p> <p><b>TZ-75</b> 65:7,12,16, 24</p> <hr/> <p style="text-align: center;"><b>U</b></p> <hr/> <p><b>U.S.</b> 82:15,19 129:18,21 142:10 155:2 168:6,13 170:13,16</p> <p><b>ugly</b> 138:12,13</p> <p><b>Uh-huh</b> 23:4 50:7 61:9 67:17 86:22 97:23 113:8,11 136:10</p> <p><b>unaware</b> 23:19 50:15</p> <p><b>unconstitutionally</b> 11:17</p> <p><b>underneath</b> 91:4 130:2,5,22</p> <p><b>understand</b> 9:23 11:8,25 12:7,22 14:1,3 20:7 21:12 25:6,13 35:25 52:10 60:12 61:13 70:2 71:6,9 85:9, 21 90:6 91:12 107:3 118:17 120:7,23 129:7 131:2 133:3 137:4 142:19 143:2 158:6,11</p>	<p><b>understanding</b> 13:2,12,16,24 18:6,11,12,13 20:9 25:8 52:1,19 53:1 60:8,16,17 61:5 70:22 89:10, 13,25 90:13 91:2, 15 100:7 101:9 104:16 107:6 116:18 117:14,17 118:5,8,14 119:1 120:12,15 129:4 130:9,18 133:14, 17 168:19</p> <p><b>understood</b> 7:3 8:18 11:12 15:21 19:1 34:1 53:22 83:20 86:17 147:16 149:1</p> <p><b>undoubtedly</b> 90:24</p> <p><b>uneven</b> 138:23</p> <p><b>United</b> 5:14 84:15 155:24 167:17 169:10</p> <p><b>unnatural</b> 61:15</p> <p><b>unreliable</b> 122:12</p> <p><b>Updike</b> 91:24</p> <p><b>upper</b> 59:16 152:14</p> <p><b>URL</b> 41:10 49:7 115:22 131:15</p> <p><b>USC</b> 21:7</p> <p><b>user</b> 36:11</p> <p><b>utilize</b> 38:22</p> <hr/> <p style="text-align: center;"><b>V</b></p> <hr/> <p><b>V7</b> 115:14,23 116:14,23 117:11</p> <p><b>vague</b> 11:17 59:5 98:16 143:9</p>	<p>152:11 168:2</p> <p><b>vagueness</b> 6:21 11:15 13:23 139:6</p> <p><b>validate</b> 77:19</p> <p><b>Valley</b> 14:15 29:1</p> <p><b>variant</b> 70:12,18, 19,23,24,25 71:9, 14,19 76:5 154:2</p> <p><b>variants</b> 62:2 70:10 71:14 76:4 123:7</p> <p><b>variety</b> 163:15</p> <p><b>vehicle</b> 13:19</p> <p><b>vehicles</b> 32:23</p> <p><b>velocity</b> 39:3</p> <p><b>version</b> 58:11 117:11 131:5 142:16</p> <p><b>versions</b> 96:3</p> <p><b>veteran</b> 27:11</p> <p><b>video</b> 78:5,6 146:23 147:1 166:1</p> <p><b>video-recorded</b> 5:12 171:13</p> <p><b>videos</b> 29:11 126:3,7,11,15 165:17</p> <p><b>Vietnam</b> 27:8,11 86:14</p> <p><b>view</b> 39:18</p> <p><b>vise</b> 79:3,6,11,17, 19</p> <p><b>visit</b> 31:14</p> <p><b>visited</b> 29:9,14</p> <p><b>visual</b> 166:1</p> <p><b>visualizing</b> 86:1</p>	<p><b>Visually</b> 117:21</p> <hr/> <p style="text-align: center;"><b>W</b></p> <hr/> <p><b>Wabash</b> 14:14 29:1</p> <p><b>wait</b> 9:15,16 17:9, 10</p> <p><b>waive</b> 171:7,9</p> <p><b>waived</b> 5:8 171:11,18</p> <p><b>Wal-marts</b> 67:12, 25</p> <p><b>walked</b> 50:11</p> <p><b>Walther</b> 48:22,23, 24 49:5,6,8,11 50:5,9,12,20,25 52:2 53:25 54:2,8, 10 146:6</p> <p><b>Walther's</b> 49:7</p> <p><b>waltherarms.com/ pdp.</b> 49:8</p> <p><b>wanted</b> 93:22</p> <p><b>War</b> 82:18 122:10 136:18 153:18,22 167:13,14,17 168:14,21 169:8, 11</p> <p><b>watched</b> 48:25 92:9 126:3 166:9</p> <p><b>watching</b> 78:5</p> <p><b>water</b> 10:9 54:24</p> <p><b>water-cooled</b> 138:4</p> <p><b>ways</b> 28:13 148:17</p> <p><b>weapon</b> 96:25 100:9,19 101:6 106:18 107:5 117:6,9,24 118:1 137:14,15 167:17</p>
---	--	---	--

<p><b>weapons</b> 39:22 60:12 122:21 150:23</p> <p><b>web</b> 91:1</p> <p><b>website</b> 30:6,9 41:10 49:7 51:1 52:2,7 54:8 115:22 128:13,22 131:14</p> <p><b>websites</b> 29:5,7 30:13,15,23 116:7</p> <p><b>Wells</b> 5:22 6:3,7, 12,18 7:3,8,13,16, 21,23 8:4 9:1,4,6 12:20 13:7,12 16:6 17:22 19:11 20:12 21:2,5 29:24 33:10,18,21 36:19,21 38:11 39:21 41:3,7 43:7, 11 44:15 45:1 46:8,11,13,18 48:14,19 49:3,6 50:2 51:3,9 52:1 53:5,9,22 54:21, 23 55:1,4,7,10,13, 17 56:2,13 57:6 59:7 61:22 63:2,7 66:5,9 68:14,19, 22 69:22 70:2 73:22 74:4,7 75:12,17,23 80:22 81:8 86:10 87:9 88:11 92:17 97:15 98:18 100:17 101:9,12 102:6,24 106:4 107:10 108:7 109:6,12,16 110:10,14 112:3, 5,9,12 115:20 117:4 119:8,14,19 122:5 128:18 130:1 131:12 133:22 134:3,7,9, 14,20 139:3,15,21 140:1,5,25 141:20</p>	<p>142:21 143:4,9 144:19 147:10,16 148:21,25 151:1, 20 152:11 153:10 155:13 156:1,4,7 159:23,25 160:5 161:4,19,25 165:7 168:3 170:22 171:3,10</p> <p><b>Wesson</b> 12:14 18:16 20:5 37:6 67:3 68:25 69:5 110:10 111:5 114:25 115:8 162:21</p> <p><b>West</b> 5:17</p> <p><b>white</b> 128:24</p> <p><b>widely</b> 123:8</p> <p><b>Wiki</b> 31:3</p> <p><b>Wikipedia</b> 30:25 31:1 69:12 98:21</p> <p><b>Wilson</b> 5:4,13,25 7:5,25 34:5,16 75:23 139:10,17 140:22 156:8 171:13</p> <p><b>wind</b> 45:6</p> <p><b>winner</b> 133:8</p> <p><b>wiring</b> 32:23</p> <p><b>withdraw</b> 68:14 87:5 117:4 121:16 122:6</p> <p><b>won</b> 135:11,12</p> <p><b>wooden</b> 148:12 154:23</p> <p><b>word</b> 70:18,22,25</p> <p><b>words</b> 9:13 11:16 65:22</p> <p><b>wore</b> 60:18</p> <p><b>work</b> 23:16 33:13</p>	<p>35:18 38:10,13 39:3 42:7 64:15, 25 78:16,17 88:6 159:14,18</p> <p><b>worked</b> 32:4 88:7</p> <p><b>works</b> 40:17 77:1</p> <p><b>world</b> 15:19 41:24 82:18 88:23 89:1 92:3 122:9,21 123:8 136:18 153:18,22 167:13, 14,17 168:14,21 169:8,11</p> <p><b>worry</b> 62:24</p> <p><b>wounded</b> 122:11, 12</p> <p><b>wow</b> 68:3 76:23</p> <p><b>write</b> 17:17</p> <p><b>writings</b> 32:14</p> <p><b>written</b> 7:4 132:20 139:9 140:2</p> <p><b>wrong</b> 39:23 76:22,23 95:14 112:5 138:24 144:6</p> <p><b>wrote</b> 21:19 22:21 99:13 105:15</p> <hr/> <p style="text-align: center;"><b>X</b></p> <hr/> <p><b>XD</b> 78:12,15,17 79:24 80:4</p> <p><b>XL</b> 110:17</p> <p><b>XLIII</b> 110:19</p> <hr/> <p style="text-align: center;"><b>Y</b></p> <hr/> <p><b>yards</b> 44:20 45:5</p> <p><b>year</b> 164:6,21 165:2 170:23</p>	<p><b>years</b> 118:2 127:1, 2 135:25 136:8 155:25 162:24 163:13</p> <p><b>yesterday</b> 7:9</p> <p><b>yields</b> 25:16</p> <p><b>Youtube</b> 28:15,16 29:12 76:12,13 78:2,5,6 126:3,7, 11,15 166:2,3</p> <p><b>Yurgealitis</b> 49:14, 20 50:21</p> <p><b>Yurgealitis'</b> 50:8 69:21,25</p>
--	--	--	--

# Exhibit A-1



IN THE UNITED STATES DISTRICT COURT  
FOR THE SOUTHERN DISTRICT OF ILLINOIS

CALEB BARNETT, et al., )  
)  
Plaintiffs, )  
)  
vs. )  
)  
KWAME RAOUL, et al., )  
)  
Defendants. )

Case No. 3:23-cv-209-SPM

DANE HARREL, et al., )  
)  
Plaintiffs, )  
)  
vs. )  
)  
KWAME RAOUL, et al., )  
)  
Defendants. )

Case No. 3:23-cv-141-SPM

JEREMY W. LANGLEY, et al., )  
)  
Plaintiffs, )  
)  
vs. )  
)  
BRENDAN KELLY, et al., )  
)  
Defendants. )

Case No. 3:23-cv-192-SPM





**STATEMENT PURSUANT TO 28 USC 1746**

1. My name is Matthew Wilson, I am a Plaintiff in this case, a U.S. Citizen, am over 21 years of age, under no legal disabilities, and make this sworn statement under personal knowledge.
2. I reside in Crawford County, Illinois. Since this ban on firearms and magazines was passed, retailers in my area have stopped selling these items, even items that I think are legal under the act the retailers are afraid to sell, as they are not sure what is actually legal under the Act. Some retailers claim to have been told that literally screwdrivers are prohibited under the act.
3. I am a lifetime firearm owner, and am familiar with most kinds of common firearms and magazines.
4. The 1919 Browning series traditionally uses cloth belts like those shown in the motion, both for 1919s in the original machinegun version, as well as later rifle and "other" versions.
5. Some 1919s, including the rifle configuration and the other configuration, use more modern disintegrating links, instead of a cloth belt.
6. I personally own at least one rifle that uses the same magazine as at least one pistol I own uses. The magazines for the rifle and the pistol are made by the same company, and are indistinguishable from either other, as they are identical.
7. I am familiar with the Mossberg Blaze 47, having personally seen one for sale. It is a blowback operated .22 LR caliber rimfire, with nothing in common with an actual Ak47, other than the general shape of its shadow on a sunny day.

8. Models of firearms I can think of off hand, which use magazines that can be and commonly are used in both rifles and pistols, as well as "other" firearms, are AK47 type magazines, AR15 type magazines, Luger magazines, 1911 magazines, Smith and Wesson 59 magazines, Ruger 10-22 magazines, Soviet PPS43 type magazines, Uzi type magazines, and Thompson model 1928 type magazines.
9. There is no objective way that a person can determine that any ammunition feeding device is for a rifle, shotgun, pistol or other firearm, without knowing its design history, possibly going back well over a century, and without knowing about every single firearm ever made that might use that assumption feeding device.
10. Likewise, there are no objective standards to determine whether a given firearm is an AK type, an AR type, or something else. In fact, even the listed examples are often times not within the parameters of what even most firearms experts would consider to be an AK type, like the SKS, or an AR type.
11. That I have read the Plaintiff's Motion for Partial Summary Judgment as to Counts IV and VI, and to the best of my knowledge, the facts set forth in this sworn statement, and in that motion, are true and correct. The photographs depicted show what they are labeled as correctly, and the descriptions contained in the motion are accurate.
12. If I were to testify in open court, I would testify consistently with this affidavit.
13. I declare under penalty of perjury under the laws of the United States of America that the foregoing is true and correct.

Dated: 5-17-27



Matthew Wilson

Handwritten signature or initials.

Handwritten text, possibly a date or reference number: 5-15-23

# Exhibit A-2



AFFIDAVIT OF MATTHEW WILSON

Comes now Matthew Wilson, being first sworn, and states under penalties of perjury, as

follows:

1. My name is Matthew Wilson. I am one of the Plaintiff's in this case.
2. I have been provided, and have read, the Supplemental Affidavit of James E. Yurgealitis, filed as document 116-1.
3. Unlike Mr. Yurgealitis, I am being provided no compensation for my testimony or participation in this case.
4. After reading said Supplemental Affidavit, I seriously question the purported knowledge that Mr. Yurgealitis claims to possess, as he makes bald statements of fact that are objectively simply not true.
5. For instance, Mr. Yurgealitis claims that, in 9mm, the following handguns feature 15 round magazines that are not interchangeable with any rifles or other long guns, and listed the following:

- a. CZ: Model 75, Shadow;
- b. Heckler & Koch: P30, P2000, USP;
- c. Sig Sauer: P226, P229;
- d. Smith & Wesson: 5900 Series, SW40F;
- e. Sturm Ruger: P85, P89;
- f. Springfield Armory: XD Series; and
- g. Walther: P88, PPQ, PDP.

6. Mr. Yurgealitis' statement is largely false, to wit:

- a. The CZ, Model 75 and the Shadow are variants of the same pistol, use the same magazine, and the magazines are also used in the Kel Tec Sub 2000 Gen



2 rifles. See Ex. A, B, C.D. These are also similar to the Tanfoglio TZ75, formerly imported by FIE or Florida in the 1980s, and the AR-24 Pistol, formerly imported by Armalite, which itself is a CZ75 clone.

- b. As far as the Smith and Wesson 5900 Series, the pistol is discontinued, but uses the same magazine as the also discontinued Marlin Camp rifle, in 9mm. See Ex E. Marlin camp rifles used to be sold as most Wal-Marts.
  - c. As to the Ruger P85 and P89, they are variants of the same basic pistol, the P89 being a product improved variant of the P85. Both pistols use the same magazine as the Ruger PC9 rifle. See. Ex. F, G.
  - d. As to the Springfield Armory XD Series, it is actually a Croation made pistol, made by HS Produkt, and the magazines it uses are largely interchangeable with the Beretta M92 Series, except that one needs to cut a single notch in the XD magazines to make them work in the M92, or a single notch in a M92 Beretta magazine to make them work in an XD. In fact, during the mid to late 1990s, when new over 10 round magazines were restricted, but existing over 10 round magazines were unrestricted, it was common for owners of XD pistols to obtain surplus M92 magazines and modify them for use in the XD pistol.
7. While I am personally unaware of any rifles that use the other listed magazines, there is no reason that such a rifle could not be constructed, nor is there any way to know whether or not any such rifles have been so constructed and sold. Any claim that *any* magazine can *only* fit a handgun or *only* fit a rifle is absurd on its face. In fact, any handgun, ultimately, can be converted into a rifle. For instance, as listed in the ban itself, DSA

makes or made a FAL pistol. The FAL magazine is very similar to the M14 magazine in size and general design.

8. As far as owners of M9 / Beretta M92 style 9mm pistols, who are also owners of Beretta CX4 rifles, I am on, as are the other two named Plaintiffs in this lawsuit. If the Court would care to see a demonstration of the interchangeability of the magazines in my Beretta Pistol and rifle, I am happy to personally demonstrate same.
9. Furthermore, from a purely technical perspective, there is and are no reasons why a 20, 30 or 40 round magazine could not be modified to accept and feed only either 15 rounds, 10 rounds or even 5 rounds. In the 1950s, it was a common practice for owners of M1 Carbines, which come standard with 15 or 30 round magazines, to convert 30 round magazines to 5 round magazines to comply with the hunting regulations of the era, since it was cheaper to convert a 30 round magazine than to make a 5 round magazine new. The issue, is how is one to know that a given 15 through 11 round magazine is a "handgun magazine" as opposed to a "rifle magazine.", or a 16 round magazine is for a firearm other than a rifle, shotgun or handgun, as defined. The ambiguity is on the magazine, not the firearm it may fit into.
10. In fact, depending on the cartridge used, a magazine that holds 30 rounds of one cartridge may well only hold 10 rounds of another. One such actual example is the AR15 magazine, in which its standard magazine holds 30 rounds of 5.56mm ammunition, or 10 rounds of .50 Beowolf ammunition, interchangeably.
11. Defendant's expert also says,:

35. With AR platform or "AR Type" rifles, the magazines can be interchangeable between rifle and handgun variants. However, both variants are firearms that can no longer be legally purchased under the Act.

12. I am familiar with the AR7 rifle, a photograph is shown below:



13. A close up of the markings on an AR7 rifle are shown below:

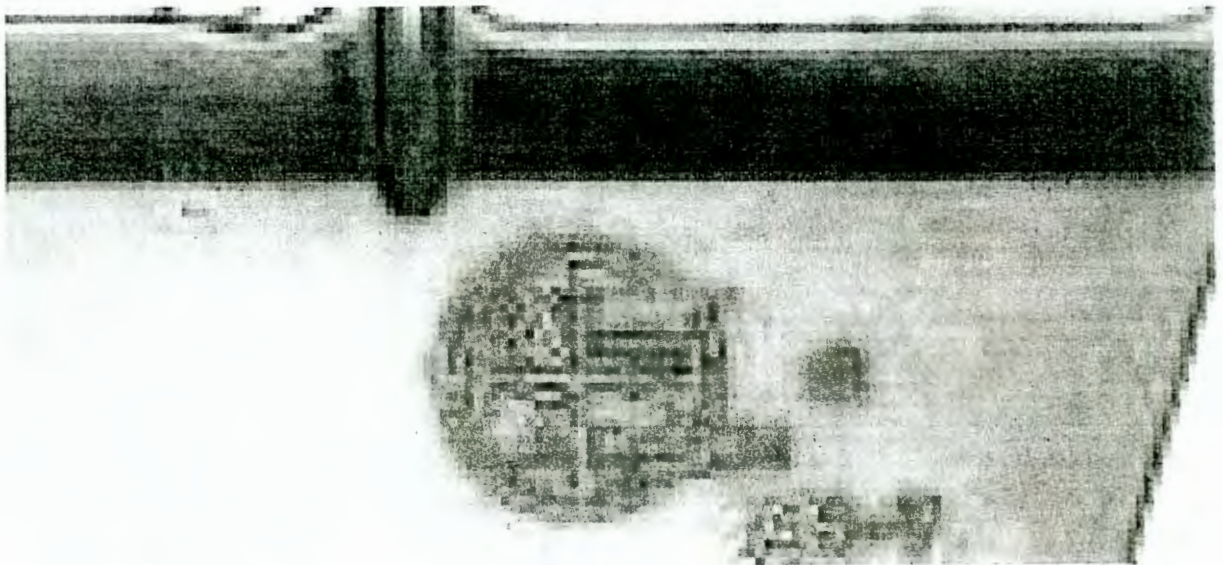

14. As can be clearly seen, the above firearm is marked as an "AR-7."

15. I acknowledge there are both handgun and rifle versions of this firearm. However, other than the AR-7 marking, I see no reason why, under the challenged act, this firearm cannot be sold or possessed, unless this is an "AR Type" firearm, which, while marked as an AR-7, I have no idea and do not see how to discern whether this is an AR type firearm.



16. Below is depicted another firearm. From my knowledge of firearms, I can see that the AR15 has clearly influenced the design, and it appears to use an AR15 type magazine. However, I have no idea if that is an "AR Type" firearm or not.

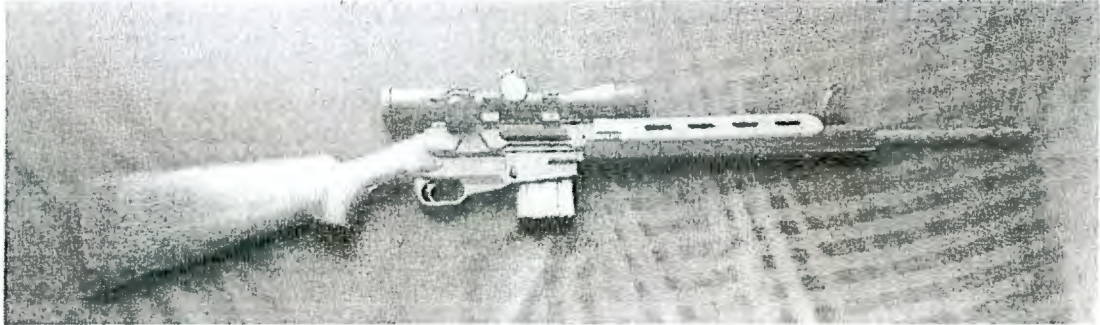

17. I am also aware of a firearm called an AR5. below is a photograph.

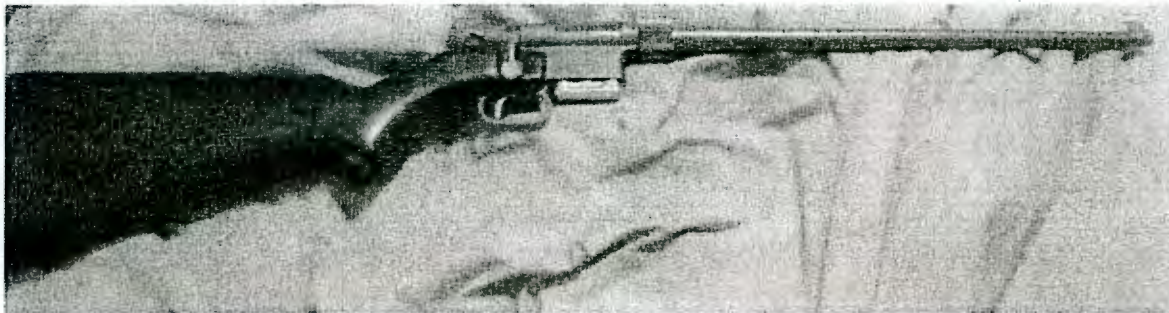

18. This is a bolt action firearm with a 4 round magazine. I do not know if this is included in the definition of an "AR type" firearm.

19. In addition, some firearms that look kind of like an AR15 are bolt action or straight pull bolt action, not semiautomatic. A photograph of one such firearm is shown below.



20. There have also been pump action firearms that look like AR15 rifles. A photograph of one such rifle is shown above.

21. I do not know if this rifle is included in the definition of "AR type," nor can I discern it, as no definition is provided.

22. As for semi-automatic 1919A4 types, they are common as dirt in Illinois. For several years they were built by many manufacturers and home builders of firearms, as the parts



from which they were made were surplus and low cost for many years. Contrary to the expert opinion, they remain in production to this case. Ex. I.

FURTHER AFFAINT SAYETH NAUGHT

DATED: 6-27-2023



Matthew Wilson

SUBSCRIBED AND SWORN

Dated: 6-27-2023



Notary



DAILY DEALS



Free Shipping on Uppers, Rifle Kits, Pistol Kits, Build Kits, Part Kits, Complete Loweres & PSA Firearms!



[HOME](#) / KEL-TEC MAG CATCH KIT FOR CZ75 SUB 2000 GEN2 RIFLES, BLACK - S2K-205CZ75

IN STOCK ▶

## KEL-TEC MAG CATCH KIT FOR CZ75 SUB 2000 GEN2 RIFLES, BLACK - S2K-205CZ75

IN STOCK ▶

## KEL-TEC MAG CATCH KIT FOR CZ75 SUB 2000 GEN2 RIFLES, BLACK - S2K-205CZ75



\$12.09

1 +

ADD TO CART



st read Compliance Information before purchasing.

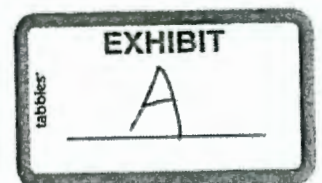

 This product is fulfilled by a PSA Partner and shipping times may **DAILY DEALS**



Model Number S2K205CZ75

UPC 640832007329

 Add to Wish List  Add to Compare Share:   

Purchase protected by  **norton** SHOPPING GUARANTEE [Learn more](#)

## PRODUCT DETAILS

### DETAILS

Material: Steel

Color: Black

For Use With: CZ75 Sub 2000 Gen2 Rifles

Includes: (1) Mag Catch Plate, (1) Hex Key, (2) Screws

### FEATURES

The CZ 75 Sub 2000 Gen2 mag catch kit, from Kel-Tec comes with hey key and screws.

The Mag Catch plates will only work in the Gen 2 SUB 2000 weapon, which states "multi mag" on the left hand side of the grip.

## REVIEWS



DAILY DEALS



## COMPLIANCE

### Shipping Restrictions

It is the customer's responsibility for understanding state laws regarding all purchases made. For a comprehensive list of all Shipping Restrictions, please refer to our Shipping Restrictions By State Page found [Here](#).

#### All NFA Rules Apply.

These items are controlled by the U.S. Government and authorized for export only to the country of ultimate destination for use by the ultimate consignee or end-user(s) herein identified. They may not be resold, transferred, or otherwise disposed of, to any other country or to any person other than the authorized ultimate consignee or end-user(s), either in their original form or after being incorporated into other items, without first obtaining approval from the U.S. government or as otherwise authorized by U.S. law and regulations.

#### AMENDMENT II

*A well regulated Militia, being necessary to the security of a free State, the right of the people to keep and bear Arms, shall not be infringed.*

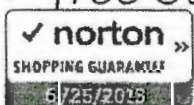





**DAILY DEALS**

Sign up for our Daily Deals on Facebook

Questions? Need help? Call us: [\(877\) 560-7229](tel:(877)560-7229)

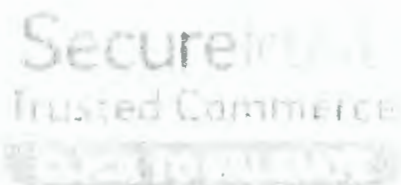
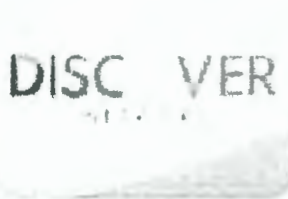

About SSL Certificates

COMPANY INFO LEGAL CONTACT INFORMATION

[Blog](#) [Check Shipping Status](#) [Terms & Conditions](#) Palmetto State Armory

[Careers](#) [My Account](#) [Retail Return Policy](#) 3760 Fernandina Rd.

[About PSA](#) [Contact Us](#) [Shipping Restrictions](#) Columbia, SC 29210

[Affiliate Program](#) [Rebates & Promotions](#) [Privacy Policy](#) **HELP CENTER**

[Retail Stores](#) [Compare Products](#) [Sitemap](#)

[Defense Courses](#) [Check Order Status](#)

[SC CWP Info](#) [Gift Card Balance](#)

[Shoot Responsibly](#) [FAQ](#)

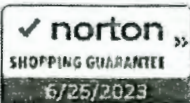

[Buying a Gun Online](#)

[FFL Locator](#)



Product Manuals

California Buying Guide

DAILY DEALS



ARMORY. © RIGHTS RESERVED.



Pistols Rifles Shotguns Parts Accessories Gear Sign In

Search ...

[Home](#) / [Magazines](#) / S2K-205 CZ75 Mag Catch Kit

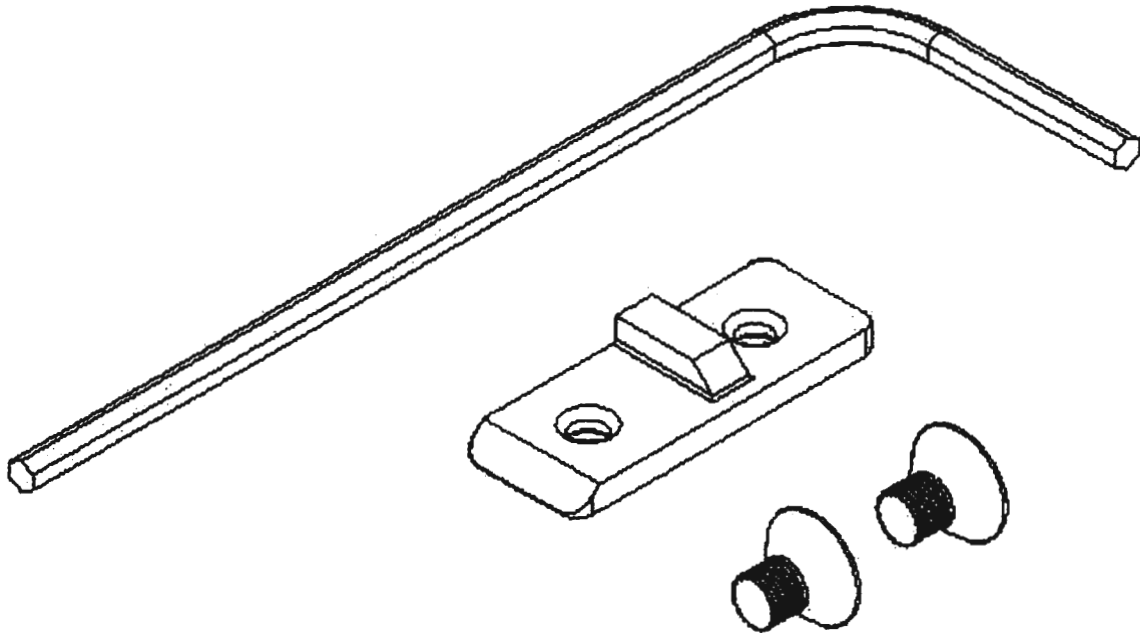

## S2K-205 CZ75 Mag Catch Kit

**SUB 2000 2ND GEN CZ75 MAG CATCH KIT**

**THE MAG CATCH PLATES WILL ONLY WORK IN THE GEN 2 SUB 2000 WEAPON, WHICH STATES "MULTI MAG" ON THE LEFT HAND SIDE OF THE GRIP.**

**INCLUDES;**

**1- CZ75 MAG CATCH PLATE**

**1- HEX KEY**

**2- SCREWS**

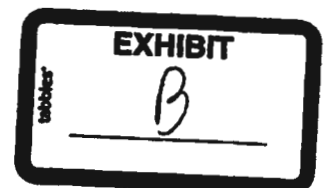

[Pistols](#) [Rifles](#) [Shotguns](#) [Parts](#) [Accessories](#) [Gear](#) [Sign In](#)

**\$13.99**

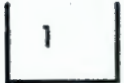

ADD TO CART

PRODUCT CODE: S2K-205CZ7S CATEGORY: Magazines

## KELTEC INFO:

[About](#)  
[Careers](#)  
[Distributor List](#)  
[HALO](#)  
[Media Kit](#)  
[Terms & Conditions](#)  
[Privacy Policy](#)  
[Sitemap](#)

---

## FIREARM INFO:

[Recall](#)  
[Owner's Manuals](#)  
[Discontinued](#)  
[Digital Catalog](#)  
[U.S. Firearm Magazine Restrictions](#)

---

## NEWS:

[Press](#)  
[KelTec Insider](#)

---

## CUSTOMER SERVICE:

[Gift Cards](#)  
[Shipping & Returns](#)



Pistols

Rifles

Shotguns

Parts

Accessories

Gear

Sign In



Support Ticket

Contact



# **KELTEC®**





SHOWING ALL 11 RESULTS

FILTER

SORT BY LATEST



COMPETITION CZ 75B / 85B / SP-01 / SHADOW / SHADOW 2  
9MM 10-ROUND

\$68.25



COMPETITION C7 75B / 85B / SP-01 / SHADOW / SHADOW 2  
9MM 19-ROUND

\$68.25

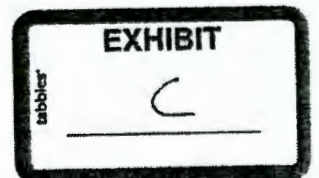



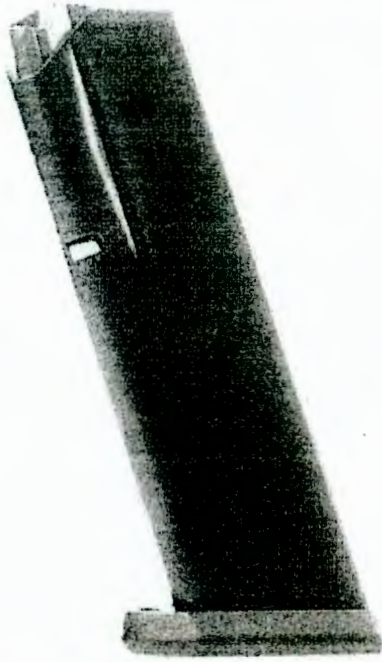

CZ 75 COMPACT / P-01 / PCR 9MM 15-ROUND  
\$40.20

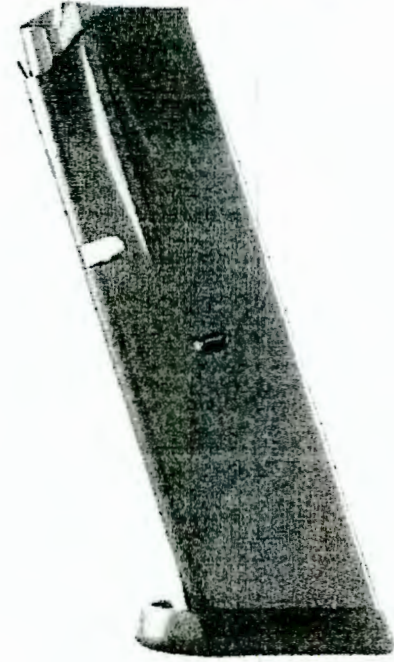

CZ 75 COMPACT / P-01 / PCR 9MM 10-ROUND  
\$32.65



CZ 75B / 85B / SP-01 / SHADOW / SHADOW 2.40 S&W 14-ROUND  
DPS  
\$48.85

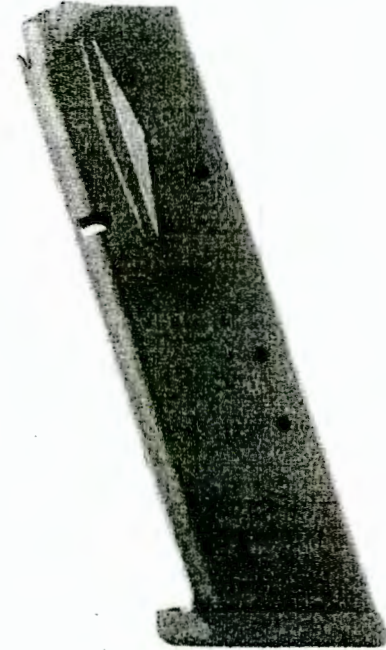

CZ 75B / 85B / SP-01 / SHADOW / SHADOW 2.40 S&W 12-ROUND  
\$40.20

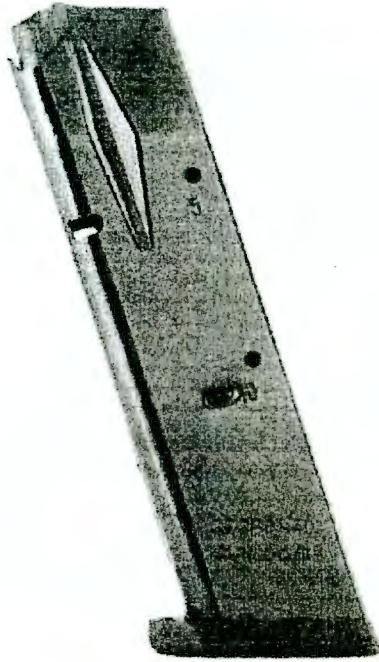

CZ 75B / 85B / SP-01 / SHADOW / SHADOW 2.40 S&W 10-ROUND  
\$32.65



CZ 75B / 85B / SP-01 / SHADOW / SHADOW 2.9MM 19-ROUND  
DPS  
\$49.85

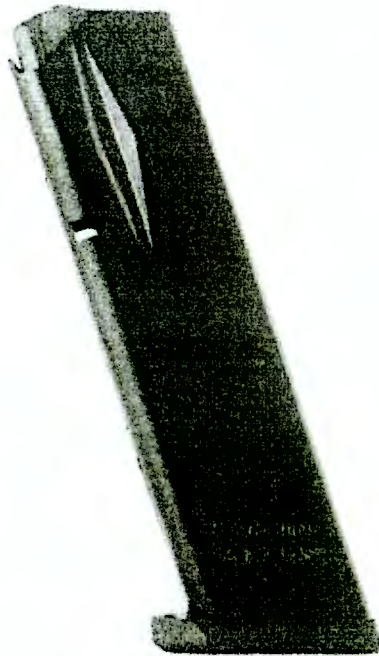

CZ 75B / 85B / SP-01 / SHADOW / SHADOW 2.9MM 17-ROUND  
\$41.05



CZ 75B / 85B / SP-01 / SHADOW / SHADOW 2.9MM 16-ROUND  
\$33.30

SOLD OUT

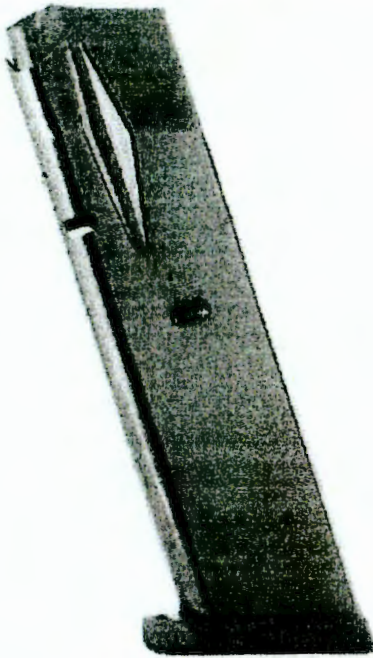

CZ 75B/85B/SP-01/SHADOW/SHADOW 2 9MM 10-ROUND

\$33.30

 **MEC-GAR**



905 Middle Street  
Middletown, CT  
06457 USA

[mags@mec-gar.com](mailto:mags@mec-gar.com)

(860) 635-1525



### Magazines

1911  
ARMSCOR/Rock Island Double Stack  
Bersa

1911 Officer  
Beretta  
Browning



CZ	Kimber
Luger	Para-Ordnance
Ruger	S&W
Sig Sauer	Springfield
Taurus	Walther
Witness - Tanfoglio	

## About

[Blog / News](#)

[IFS - Innovation For Shooters](#)

[Contact Us](#)

secured by

## Help

[FAQ](#)

[Contact Us](#)

© 2001 - 2022 Ford Car USA Inc. All rights reserved.

[Terms and Conditions](#) | [Privacy](#) | [Legal Notice](#) | [Cookie Policy](#)

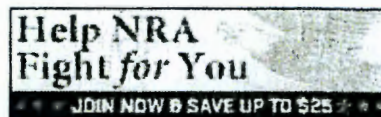

We accept

BBB

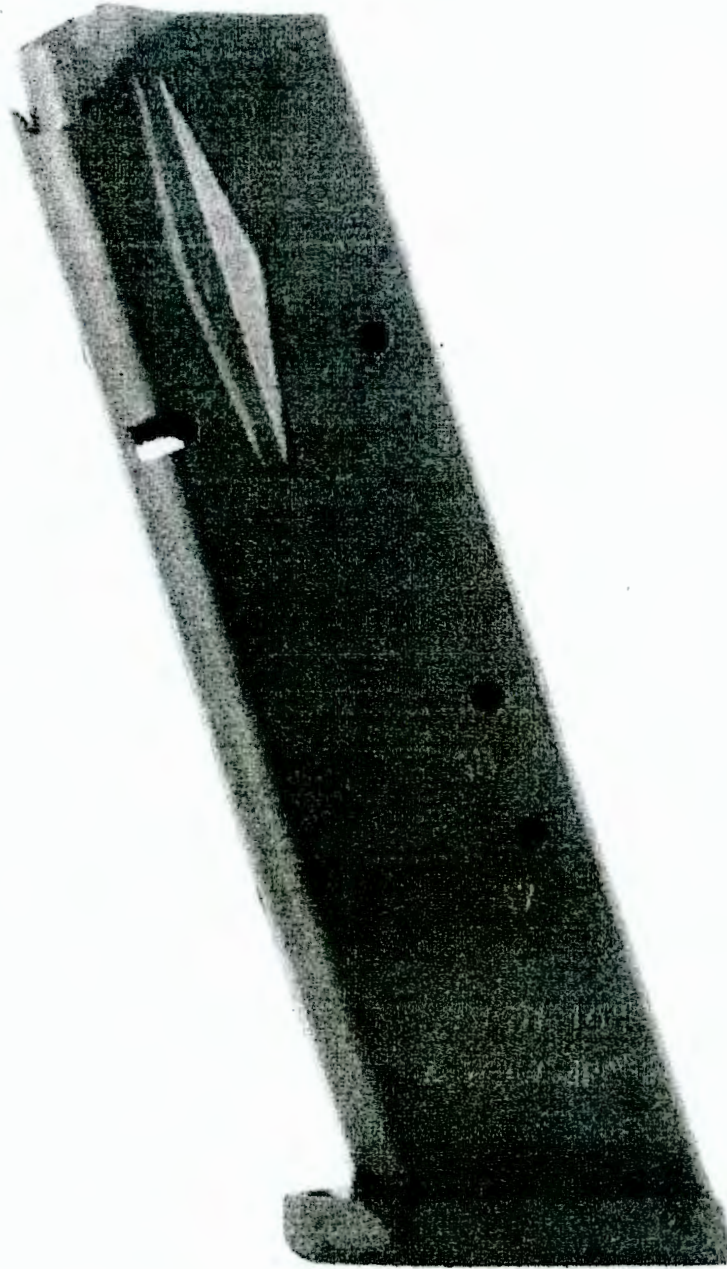

STORE , MAGAZINES , CZ

CZ 75B / 85B / SP-01 / SHADOW / SHADOW 2.40  
S&W 12-ROUND





Case 3:23-cv-00209-SPM Document 117-1 Filed 06/27/23 Page 22 of 43 Page ID #3603  
\$40.20

**Compatible Firearms:** CZ 75B, 85B, SP-01, Shadow, Shadow 2

**Caliber:** .40 S&W

**Capacity:** 12 rounds (11 round compared to factory magazines and still flush fit)

**Coating:** Anti-friction

**Follower:** High-impact polymer

**Tube:** Heat treated carbon steel

**Spring:** High tensile music wire

**Floorplate:** High-impact polymer that sits flush with the pistol

**SKU (Blued):** MGCZ4012AFC - **UPC:** 765595515727

- Anti-Friction coating allows for easy loading, reduced malfunctions, and superior anti-corrosion properties

 IN STOCK



 **State Capacity Restriction**



**Safe Shopping**

Buy with confidence, your data is safe.

**Flat-Rate Shipping**

Get your items quickly with flat rate USPS.

SKU: MGCZ4012AFC

SHARE      

## Description



**.40 S&W - 12 rounds**

If you are looking for a magazine for your CZ 75B, 85B, SP-01, Shadow, Shadow 2 pistol, choose the magazine manufacturer that is the most trusted in the industry.

All Mec-Gar magazines are made in Italy with the most sophisticated technologies and best materials.

Since 1965 Mec-Gar has been a world leader in the production of magazines for the largest firearm manufacturers and militaries in the world.

## Specifications

<b>CALIBER</b>	.40 S&W
<b>CAPACITY</b>	12-round
<b>FINISH</b>	Anti-Friction
<b>FIREARM MAKE</b>	CZ
<b>MODEL</b>	CZ 75B, CZ 85B, CZ Shadow, CZ Shadow 2, CZ SP-01

REVIEWS (0) +

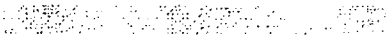



905 Middle Street  
Middletown, CT  
06457 USA

mags@mec-gar.com  
(860) 635-1525



### Magazines

1911  
ARMSCOR/Rock Island Double Stack  
Bersa  
CZ  
Luger  
Ruger  
Sig Sauer  
Taurus  
Witness - Tanfoglio

1911 Officer  
Beretta  
Browning  
Kimber  
Para-Ordnance  
S&W  
Springfield  
Walther

### About

Blog / News  
IFS+ - Innovation For Shooters  
Contact Us

secured by

**Help**

FAQ

Contact Us

© 2001 - 2022 Mac-Gor USA Inc. - All rights reserved.

[Terms and Conditions](#) | [Privacy](#) | [Legal Notice](#) | [Cookie Policy](#)

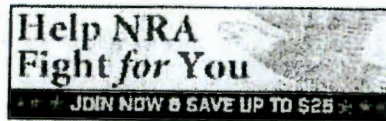

We accept

**WIKIPEDIA**  
The Free Encyclopedia

[Toggle the table of contents](#)

# Marlin Camp Carbine

The **Marlin Camp Carbine** is a self-loading carbine chambered for either 9mm Parabellum or .45 ACP, formerly manufactured by Marlin Firearms Company of North Haven, Connecticut. The carbine has been discontinued since 1999.<sup>[1][2]</sup>

## Description

As the name implies, it was designed as a utility firearm to be used around hunting camps for foraging or defense. It was made in 9mm Parabellum and .45 ACP calibers and can use the same magazines as popular handguns in those calibers, in keeping with a convenient American tradition of having a carbine and handgun using common ammunition. The carbine operates by direct blowback. Usually, the receiver is drilled and tapped for a scope mount. The stock was made of walnut-finished Maine birch.<sup>[1][3]</sup>

The Camp Carbine uses a detachable magazine that inserts into the magazine well in front of the trigger guard. The Camp-45 rifle magazine is compatible with most Colt 1911-type magazines; and the Camp-9 rifle magazine can be replaced by magazines from 59-series S&W pistols.<sup>[1]</sup> The Camp-9 magazine well is sized for 12-round magazines; magazines with higher capacities extend beyond the bottom of the well. A 20-round magazine was produced, but discontinued in 1989.<sup>[1][2]</sup> Numerous aftermarket magazines and drums were produced for both models.

## References

1. Fjestad, S.P. (2009). *Blue Book of Gun Values 2009*. Blue Book Publications. p. 798. ISBN 978-1-886768-87-1.
2. Warner, Ken (1999). *Gun Digest 2000. 54th Annual Edition*. Krause Publications. p. 306. ISBN 0-87341-752-6.
3. William S. Brophy. *Marlin Firearms: A History of the Guns and the Company That Made Them*. p. 319.

## External links

- Marlin "Camp 9" Carbine (<https://web.archive.org/web/20211024212259/http://www.alpharubicon.com/leo/marlincamp9war.htm>)
- Marlin Camp Carbines (<https://web.archive.org/web/20221208170544/http://notpu/campgun9.htm>)

### Marlin Camp Carbine



Marlin Camp-45

<b>Type</b>	Hunting rifle
<b>Place of origin</b>	United States
<b>Production history</b>	
<b>Manufacturer</b>	Marlin Firearms Company
<b>Produced</b>	1985–1999
<b>Variants</b>	9mm and .45 ACP Versions
<b>Specifications</b>	
<b>Mass</b>	6¾ pounds
<b>Length</b>	35½"
<b>Barrel length</b>	16½"
<b>Cartridge</b>	.45 ACP 9mm Parabellum
<b>Action</b>	Direct blowback semi-automatic
<b>Feed system</b>	4 or 7-round (Camp-45) 4, 12, or 20-round (Camp-9) Detachable pistol magazine
<b>Sights</b>	Fixed, drilled, and tapped for scope mounts





- [Marlin Camp 9 Manual \(https://web.archive.org/web/20230110172931/http://pdf.textfiles.com/manuals/FIREARMS/marlin\\_9.pdf\)](https://web.archive.org/web/20230110172931/http://pdf.textfiles.com/manuals/FIREARMS/marlin_9.pdf)
- [Marlin Camp 45 Manual \(https://archive.org/details/marlin-model-45-manual/\)](https://archive.org/details/marlin-model-45-manual/)

---

Retrieved from "[https://en.wikipedia.org/w/index.php?title=Marlin\\_Camp\\_Carbine&oldid=1149948132](https://en.wikipedia.org/w/index.php?title=Marlin_Camp_Carbine&oldid=1149948132)"

**Toggle limited content width**

Search the store



**Log In / Register** to View **Member Pricing** if Available. Use The **Request For Quote Button** For RFQs, Quantity Discounts, Out-Of-Stock Items, or Agencies / Qualified Individuals Looking to Purchase & Ship **Regulated Products to Restricted States.**

- 10% OFF Storewide use coupon code JULY4 At Checkout -

HOME / GUN MAGAZINES / RUGER PC9 & P89 9mm 15-Rounds Magazine



RUGER

### Ruger PC9 & P89 9mm 15-Rounds Magazines

(No reviews yet)

[Write a Review](#)

SKU: Ruger-90233

UPC: 736676902330

MPN: 90233

WEIGHT: 0.20 LBS

**\$27.98**

or 4 interest-free payments of \$7.00 with [sezzle](#)

PayPal Checkout Disabled Due to Restrictions.

QUANTITY:

1



#### Related Products

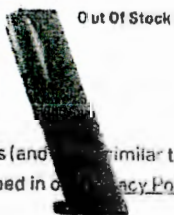

Out Of Stock

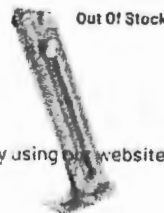

Out Of Stock



Out Of Stock

We use cookies (and similar technologies) to collect data to improve your shopping experience. By using our website, you're agreeing to the collection of data as described in our [Privacy Policy](#).

Settings [Reject all](#) [Accept All Cookies](#)

\$47.98	Ruger American Magazines 17-Rounds Ruger \$29.98	Ruger LCPC Compact 9mm 12-Rounds Magazines Ruger \$29.98	Magazines Ruger \$19.98	Magazines Ruger \$29.98
---------	---	---	-------------------------------	-------------------------------

Customers Also Viewed

Ruger Security-9mm 15-Rounds Magazines 2 Pack Ruger \$47.98	Ruger American 9mm Magazines 17-Rounds Ruger \$29.98	Ruger, LCP II 22LR Threaded Barrel Kit, 1/2 x 28 RH Threads, Fits LCP II 22LR Ruger \$160.95	Ruger LC Carbine 5.7x28mm 16.25" 20+1rd Rifle Ruger \$699.98	Ruger 90462 BX-Trigger Fits 10/22 Ruger Now: \$69.98 Was: \$36.95	Ruger AR Now: \$1,199.98 Was: \$1,199.98

Description

Ruger 9mm Luger 15rd magazine for the P89 (Serial No. 304-70000 & Above), P83 P84 P85 pistols & 409 Carbine

- Pricing Unit: Each
- Mode: P Series
- UPL: /366/63253D
- SKU: 90233
- Width: 3.50
- Length: 7.50
- Height: 1.50
- Weight: 0.20
- Caliber: 9mm
- Capacity: 15 Rounds
- Dimension: 1.50 x 3.45 x 8.70
- Finish: STAINLESS STEEL (SILVER)
- Series: Magazine
- Similar Items: CL RUG
- Style: Detachable

**WARNING** This product may contain chemicals known to the State of California to cause cancer and birth defects or other reproductive harm. For more information go to [www.P65Warnings.ca.gov](http://www.P65Warnings.ca.gov). You must be 18+ years old to shop and/or purchase on our website and 21+ to purchase Ammunition/Firearms. Check local laws before ordering as you certify you are of legal age and satisfy all federal state and local regulatory requirements. There are NO returns or exchanges on most firearms, ammunition, CFP equipment, Airsoft, BB guns or the lower 48 states.

We use cookies (and other similar technologies) to collect data to improve your shopping experience. By using our website, you're agreeing to the collection of data as described in our [Privacy Policy](#).

Additional Information



(<https://shopruger.com/login.asp>)

(<https://shopruger.com/basket.asp>)0

All Items (default.asp) / Centerfire Pistol Accessories (Centerfire-Pistol-Accessories/departments/1000/) / P-Series (P-Series/departments/1400/) / Magazines & Loaders (Magazines-Loaders/products/1401/)

### P-Series 9mm 15-Round Magazine

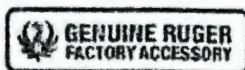



Item Number: 90233

Review Average: ★★★★★

Number of Reviews: 6

[View Reviews \(https://shopruger.com/P-Series-9mm-15-Round-Magazine/productinfo/90233/#reviews\)](https://shopruger.com/P-Series-9mm-15-Round-Magazine/productinfo/90233/#reviews) | [Review this item \(writeReview.asp?number=90233\)](#)

\$42.95

Out of Stock

Quantity

- 1 +

I am a US Citizen or a Resident Alien.



### Detailed Description

P89 (Serial No. 304-70000 & Above), P93, P94, P95™ pistols & PC9 Carbine. Stainless steel, 15-Round, 9mm magazine.

*15-round magazines are not available in all states and locales. Ruger cannot bill to or ship 15-round magazines to the following states and cities: California; Boulder, Colorado, Connecticut, Hawaii, Illinois, Maryland, Massachusetts, New Jersey, New York, Rhode Island, Vermont, Washington State, Washington DC. DO NOT ORDER THIS PRODUCT if you live in these locations.*

Genuine Ruger® Factory Accessory. NOTE: This magazine does NOT fit the PC Carbine™.

**WARNING: Discharging firearms in poorly ventilated areas, cleaning firearms, or handling ammunition may result in exposure to lead and other substances known to the State of California to cause birth defects, reproductive harm, and other serious physical injury. Have adequate ventilation at all times. Wash hands thoroughly after exposure.**

Product Reviews  
[number=90233](https://shopruger.com/writeReview.asp?number=90233)

[Click here to review this item\(https://shopruger.com/writeReview.asp?number=90233\)](https://shopruger.com/writeReview.asp?number=90233)

★★★★★

Great Job RUGER!

5/27/2019

Sent in a Mag to Ruger! Spring was broken! They replaced it no questions! I bought 2 from Pro-Mag warehouse and they are not even close to the QUALITY..... Im Buying replacements as soon as POSSIBLE!

- Bill Donoho, MO

★★★☆☆

Just a teeny bit disappointed

4/4/2019



I would have given 5 stars but I did not get my discount and the one I received looked used. It had some gummy stuff on it and appears to have been stored in a leather pouch or something similar. But it functions as designed. So other than not getting the discount Im okay with it. It works. Thats the main thing.

- Don, TN

★★★★ Good magazine 3/13/2019

Bought two of these for my P-94. Work ok but I could only get 14 bullets instead of 15 into them.

★★★★★ Magged Up 2/12/2018

Ive purchased one of these for a P95. It works flawlessly every time I go to the range. I plan on buying two more.

- Chuck, LA

★★★★★ Perfect accessory for the P series 1/18/2017

I have purchased several of these and had no issues with any of them. The springs are a little on the stiff side but they get easier to load after usage. I recommend them for sure.

- Gary Fagg, NC

★★★★★ Great magazine 10/16/2014

This is a very sturdy and well made magazine, as one would expect with a Ruger product. The spring was seriously stiff when purchased, but once broken in it is easy to load. Also I have left the magazine fully loaded for over a year and it has yet to lose any elasticity in the spring. Never had any malfunctions and the mag feeds flawlessly.

- Harry, FL

by JEREMIAH KNUPP posted on July 17, 2021  
NEWS, RIFLES, SEMI-AUTO RIFLES

Support NRA American Rifleman



(Top to Bottom) Kel-Tec SUB-2000 -9 mm Luger, Ruger PC Carbine- .40 S&W, Angstadt Arms' Ma. on Armory- 10 mm Auto, Fiedler & Koch USC - .45 ACP

Holly Marcus

The idea of pairing a handgun and a rifle around a common cartridge is an American tradition. Some of the earliest, self-contained-cartridge, repeating firearms, such as the Henry rifle, used a pistol-size chambering. The short overall length of these cartridges allowed plenty of rounds to be stacked within a tubular magazine, and their low power wasn't overly taxing on the locking mechanisms of early repeaters. Colt, Smith & Wesson and many other manufacturers would eventually offer revolvers chambered in .44 Henry rimfire.

The system had its advantages in the frontier days of the republic, with revolvers made by Colt, Merwin Hulbert and Remington using the same cartridges as rifle designs by Marlin, Remington and Winchester. The lawman or settler had a single supply of cartridges for both his rifle and handgun. The handgun provided a conveniently carried arm, while the longer barrel of the carbine gave slightly more power out of the same cartridge, along with the increased accuracy, range and capacity of a longarm.

In the 20th century, pistol-size cartridges were adapted to designs beyond the traditional lever-action and revolvers. One of the earliest American sporting semi-automatic rifles was the Winchester Model 1905. Its simple blowback action fired what was basically a pistol cartridge with a straight-wall case that launched a .32-cal., 165-gr. bullet to just under 1400 f.p.s. from its 22" barrel—very close to the performance I got from the modern .40 S&W rifle I tested here.

The past decade has seen a resurgence in the semi-automatic form of what is now known as "pistol-caliber carbines" (PCCs). These newer firearms have often taken things one step further, by adding compatibility with not only a pistol's ammunition, but also its feeding device. Glock magazines have become the predominant choice, but for nearly every popular semi-automatic handgun there is a rifle that uses the same magazine.

The 16" barrel that most PCCs use stretches the performance of pistol cartridges. For this evaluation, I compared the ballistics of the same cartridge fired from one of our test carbines and a "service-size" handgun. The results are shown in the accompanying table (p. 74). The extra 11.5" of barrel netted a velocity gain of between 13 and 19 percent and a gain in muzzle energy of between 27 and 40 percent.

To survey the current PCC world, I looked at four very different long guns, each of which highlights a unique aspect of the market as well as the four most popular chamberings for semi-automatic PCCs.

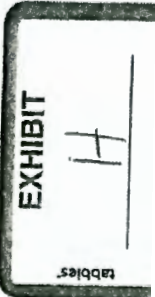



**Kel-Tec SUB-2000—9 mm luger**

One advantage of pistol-caliber carbines is that they offer an affordable option for a self-defense long gun, with companies such as Hi-Point and Kel-Tec selling PCCs for less than the cost of a basic-model AR. PCCs provide a savings on ammunition as well, since, in a normal market, cartridges such as 9 mm Luger are less expensive than rifle cartridges, allowing for more practice time on the range.

Kel-Tec's take on the PCC is to give it a folding format. The company started with the SUB-9 in 1997 and followed up with the SUB-2000 in 2001. Like its predecessor, the SUB-2000 uses a blowback action, wherein the bolt operates in a metal tube that functions as both the receiver and the mounting point for the stock. Pulling down on the trigger guard lets the rifle hinge in the middle and fold in half to the length of its 16.25" barrel. A catch at the heel of the buttstock unlocks the rifle so that it can be folded back into action. With a weight just under 4 lbs., 8 ozs., and a length under 31" when ready to fire, the SUB-2000 was the lightest and most compact of the PCCs I tested—an ideal size for being tucked into a backpack or survival bag.

The SUB-2000, available in 9 mm Luger and .40 S&W, is in its second generation, with updates including molded-in rails on the top and bottom of the fore-end, as well as M-Lok slots. Other updates include a buttstock adjustable for length of pull and a threaded muzzle. With its affordable price and unique features, the SUB-2000 has become one of the most popular PCCs, a fact affirmed by the size of the rifle's aftermarket support.

**KEL-TEC SUB-2000 SHOOTING RESULTS (50 YDS.)**

9 MM LUGER CARTRIDGE	VEL. @ 10' (F.P.S.)	ENERGY (FT.-LBS.)	GROUP SIZE (INCHES)		
			SMALLEST	LARGEST	AVERAGE
FEDERAL PREMIUM PUNCH 124-GR. JHP	1339 AVG. 28 SD	494	1.32	2.35	1.86
FEDERAL SYNTECH PCC 130-GR. TSJ	1127 AVG. 9 SD	367	1.67	2.55	2.02
WINCHESTER FORGED 115-GR. FMJ	1318 AVG. 21 SD	444	2.19	2.54	2.33
<b>AVERAGE EXTREME SPREAD</b>					<b>2.07</b>

NOTES: MEASURED AVERAGE VELOCITY FOR 10 SHOTS OVER A COMPETITION ELECTRONICS PROCHRONO DIGITAL CHRONOGRAPH AT 10 FT. ACCURACY RESULTS FOR FIVE CONSECUTIVE, FIVE-SHOT GROUPS AT 50 YDS. FROM A CALDWELL MATRIX REST. TEMPERATURE: 57° F. HUMIDITY: 68%. ABBREVIATIONS: FMJ (FULL METAL JACKET), JHP (JACKETED HOLLOW POINT), PCC (PISTOL CALIBER CARBINE), SD (STANDARD DEVIATION), TSJ (TOTAL SYNTHETIC JACKET).



column, metal-body pistol magazines. These include the Beretta 92, CZ 75/85, Canik TP9, Smith & Wesson Model 59-series and M&P fullsize, and SIG Sauer P320 and P226, by simply switching the magazine catch.

#### KEL-TEC SUB-2000 MULTI-MAG

MANUFACTURER: KEL-TEC CNC INDUSTRIES, INC. (DEPT. AR), 1505 COX ROAD, COCOA, FL 321926; (321) 631-0068; KEL-TEC WEAPONS.COM

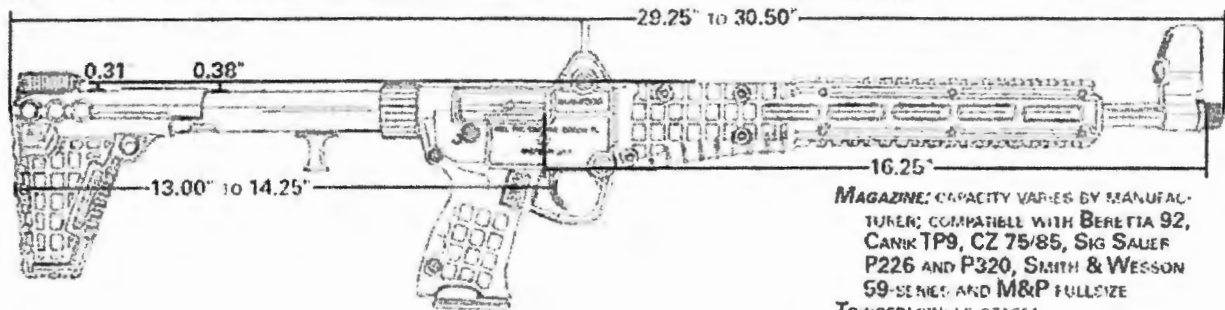

**ACTION TYPE:** BLOWBACK-OPERATED,  
SEMI-AUTOMATIC, CENTER-FIRE RIFLE  
**CHAMBERING:** 9 MM LUGER  
**RECEIVER:** STEEL  
**STOCK:** POLYMER

**BARREL:** CHROME-MOLY STEEL, MUZZLE  
THREADED 1/2X28 TPI; SIX-GROOVE,  
1:10" RH TWIST  
**SIGHTS:** FULLY ADJUSTABLE FRONT POST,  
APERTURE REAR

**MAGAZINE:** CAPACITY VARIES BY MANUFACTURER; COMPATIBLE WITH BERETTA 92, CANIK TP9, CZ 75/85, SIG SAUER P226 AND P320, SMITH & WESSON 59-SERIES AND M&P FULLSIZE

**TRIGGER:** SINGLE-STAGE;

8-LB., 13-OZ. FULL

**WEIGHT:** 4 LBS., 7 OZS.

**ACCESSORIES:** OWNER'S MANUAL, MAGAZINE CATCH STARTER KIT

**MSRP:** \$556

#### Traditionalist Favorite



#### Ruger PC Carbine—.40 S&W

The first rifle made by Sturm, Ruger & Co. was the 44 Carbine. Introduced in 1961, it was a semi-automatic rifle chambered for a revolver cartridge (.44 Mag.) that fed from a tubular magazine. Like the Winchester 1905 of a half-century prior, the Ruger Carbine cut a traditional profile with its wood stock and blued metal.

Ruger never really got out of the "rifle-chambered-in-a-handgun-cartridge" market, offering pistol chamberings in everything from its No. 3 single-shot to its Model 77 bolt-action. In 1996, it re-entered the semi-automatic PCC world with its line of "Police Carbines." The PC9 (9 mm Luger) and PC40 (.40 S&W) used magazines from the company's P-series pistols, and were manufactured for a decade.

In 2018, Ruger introduced its new, and appropriately named, PC Carbine, in both 9 mm Luger (February 2018, p. 42) and .40 S&W. The PC Carbine I tested was chambered in the latter. While handgun options in .40 S&W are dwindling these days, the cartridge is being kept alive in the PCC world by companies such as Just Right, CMMG, Kel-Tec, KRISS USA, Hi-Point and TNW.

While the PC Carbine somewhat maintains the traditional look of a big 10/22, it is packed with modern features that make it versatile. Machined into its aluminum receiver is a Picatinny rail for mounting optics. Its magazine release and charging handle are reversible. The carbine's fluted barrel is capped with a threaded muzzle. The polymer stock has molded-in sling points and a short section of universal rail on the forearm, and the length of pull is adjustable with three provided spacers. The PC Carbine utilizes a takedown system similar to that used in Ruger's takedown 10/22. A lever in the fore-end unlocks the barrel to twist free of the action, making for a package little more than 20" in length. It comes supplied with a magazine from the Ruger's SR/Security-series pistols and with an adapter to use Glock magazines (an adapter for Ruger American magazines is available as an accessory).

.40 S&W CARTRIDGE	VEL. @ 10' (F.P.S.)	ENERGY (FT.-LBS.)	GROUP SIZE (INCHES)		
			SMALLEST	LARGEST	AVERAGE
AGUILA 180-GR. FMJ	1155 AVG. 26 SD	533	1.72	2.54	2.18
FEDERAL PREMIUM PUNCH 165-GR. JHP	1245 AVG. 23 SD	568	1.64	1.94	1.80
PMC BRONZE 165-GR. JHP	1089 AVG. 21 SD	434	1.23	2.11	1.71
<b>AVERAGE EXTREME SPREAD</b>					1.90

NOTES: MEASURED AVERAGE VELOCITY FOR 10 SHOTS OVER A COMPETITION ELECTRONICS PROCHRONO DIGITAL CHRONOGRAPH AT 10 FT. ACCURACY RESULTS FOR FIVE CONSECUTIVE, FIVE-SHOT GROUPS AT 50 YDS. FROM A CALDWELL MATRIX REST. TEMPERATURE: 66° F. HUMIDITY: 63%. ABBREVIATIONS: FMJ (FULL METAL JACKET), JHP (JACKETED HOLLOW POINT), SD (STANDARD DEVIATION).

A PCC in a more traditional form gives an option to those looking for a semi-automatic rifle for plinking or self-defense in states that restrict certain firearm features (the PC Carbine is available in a version with a 10-round magazine and non-threaded barrel). Combining classic lines with modern conveniences, the Ruger PC Carbine proves that "traditional" does not have to mean "primitive."

**RUGER PC CARBINE .40 S&W**

MANUFACTURER: STURM, RUGER & CO., INC. (DEPT. AR), 411 SUNAPEE ST., NEWPORT, NH 03773; (336) 949-5200; RUGER.COM

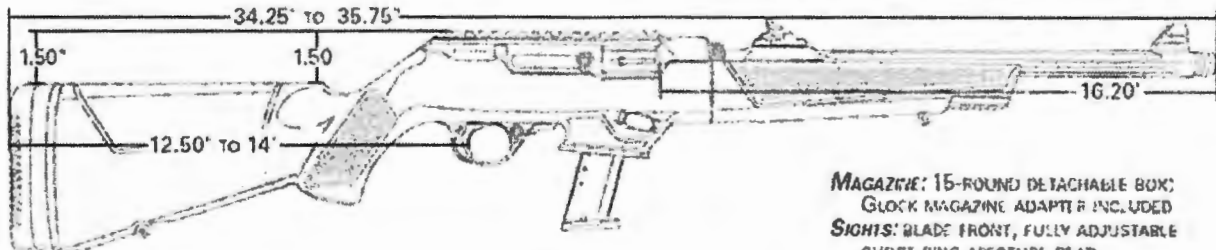

**ACTION TYPE:** BLOWBACK-OPERATED, SEMI-AUTOMATIC, CENTER-FIRE RIFLE  
**CHAMBERING:** .40 S&W  
**RECEIVER:** 7075-T6 ALUMINUM ALLOY; HARD-ANODIZED

**STOCK:** POLYMER  
**BARREL:** COLD-HAMMER-FORGED, CHROME-MOLY STEEL, Muzzle threaded 9/16x 24 TPI; SIX-GROOVE 1:16" RH TWIST

**MAGAZINE:** 15-ROUND DETACHABLE BOX; GLOCK MAGAZINE ADAPTER INCLUDED  
**SIGHTS:** BLADE FRONT, FULLY ADJUSTABLE GHOST-RING APERTURE REAR  
**TRIGGER:** SINGLE-STAGE; 6-LB., 4-OZ. FULL  
**WEIGHT:** 6 LBS. 12 OZS.  
**ACCESSORIES:** OWNER'S MANUAL, STOCK SPACERS, HEX WRENCHES, LOCK  
**MSRP:** \$349

**Semi-Automatic Subgun**



Heckler & Koch USC-.45 ACP



Beretta CX4 Storm, CZ Scorpion, FN PS90, Kalashnikov USA KR9, KRISS Vector, PTR9R, SIG Sauer MPX and Thompson Model 1927A1. These firearms have the rugged simplicity and proven reliability that comes from their military lineages. This pedigree comes at a price, as they also tend to be the more expensive firearms on the PCC market, and typically use their own proprietary magazines.

In 1999, Heckler & Koch released its UMP (Universal Machine Pistol) submachine gun. It differed from the company's legacy MP5 in several ways. It replaced metal with polymer in many areas, including the magazine and receiver, to reduce weight and cost. The MP5 rear diopter sight was changed to a simple adjustable rear sight with both aperture and open-notch leaves. The UMP also dispensed with H&K's famous roller-delayed-blowback action and used a simple blowback mechanism. A modular design, the UMP is made in 9 mm Luger, .40 S&W and .45 ACP, and the basic firearm has the ability to be converted to any of the three chamberings by swapping barrel, magazine and bolt.

The following year, the company introduced its Universal Self-loading Carbine (USC), a semi-automatic only version of the UMP for civilians. Available only in .45 ACP, the USC was in production until 2013. Due to popular demand, in 2018 it was re-introduced by H&K as a "limited production" item. Beyond the fact that it sports a 16" barrel and is semi-automatic-only, the USC has several other changes from its UMP sibling so that it can be manufactured in Germany and imported into the United States. The stock is fixed and of a one-piece "thumbhole" configuration. The rifle's 10-round magazine holds its cartridges in a single stack and is not compatible with UMP magazines.

**HECKLER & KOCH USC SHOOTING RESULTS (50 YDS.)**

<b>.45 ACP CARTRIDGE</b>	<b>VEL. @ 10' (F.P.S.)</b>	<b>ENERGY (FT.-LBS.)</b>	<b>GROUP SIZE (INCHES)</b>		
			<b>SMALLEST</b>	<b>LARGEST</b>	<b>AVERAGE</b>
<b>FEDERAL PREMIUM PUNCH 230-GR. JHP</b>	946 Avg. 23 Sd	457	1.96	2.78	2.54
<b>HORNADY AG 185-GR. XTP</b>	1132 Avg. 16 Sd	526	2.75	3.25	3.00
<b>WINCHESTER USA READY 230-GR. FMJ</b>	1000 Avg. 11 Sd	511	2.13	2.84	2.47
<b>AVERAGE EXTREME SPREAD</b>					<b>2.67</b>

NOTES: MEASURED AVERAGE VELOCITY FOR 10 SHOTS OVER A COMPETITION ELECTRONICS PROCHRONO DIGITAL CHRONOGRAPH AT 10 FT. ACCURACY RESULTS FOR FIVE CONSECUTIVE, FIVE-SHOT GROUPS AT 50 YDS. FROM A CALDWELL MATRIX REST. TEMPERATURE: 67° F. HUMIDITY: 80%. ABBREVIATIONS: AG (AMERICAN GUNNER), FMJ (FULL METAL JACKET), JHP (JACKETED HOLLOW POINT), Sd (STANDARD DEVIATION), XTP (EXTREME TERMINAL PERFORMANCE).

PCCs based on submachine gun designs offer civilians a well-engineered rifle with battle-proven credentials. In the case of the H&K USC, modern European design combines with a classic American handgun cartridge.

IMPORTER: HECKLER & KOCH USA (DEPT. AH), 5675 TRANSPORT BLVD., COLUMBUS, GA 31907; (706) 568-1906; HIN- 5A-0017



**MANUFACTURER:** HECKLER & KOCH GMBH, (GERMANY)

**ACTION TYPE:** BLOWBACK-OPERATED, SEMI-AUTOMATIC, CENTER-FIRE RIFLE  
**CHAMBERING:** .45 ACP

**RECEIVER:** POLYMER  
**STOCK:** POLYMER

**BARREL:** COLD-HAMMER-FORGED, CHROME-MOLY STEEL; SIX-GROOVE, POLYGONAL 1:16" RH TWIST  
**MAGAZINE:** 10-ROUND DETACHABLE BOX  
**TRIGGER:** TWO-STAGE; 8-LB., 4-OZ. FULL  
**SIGHTS:** POST FRONT; APERTURE/OPEN-NOTCH, FLIP-UP, FULLY ADJUSTABLE REAR  
**WEIGHT:** 6 LBS., 7 OZS.  
**ACCESSORIES:** OWNER'S MANUAL, EXTRA MAGAZINE, SOFT CASE, LOCK  
**MSRP:** \$1,150

**Glock-Mag AR With A Twist**



**Angstadt Arms/Macon Armory—10 mm auto**

In 1982, Colt introduced a 9 mm submachine gun version of the M16. Three years later, it brought out a semi-automatic 16"-barreled carbine version, and the AR-15 pistol-caliber carbine was born. They were soon joined by AR-15 innovator Olympic Arms, which expanded the pistol-caliber-AR market beyond 9 mm to include .40 S&W, .45 ACP and 10 mm Auto. Though Olympic started out using modified Uzi magazines in its PCCs, by the late 1990s it was making AR-15 lowers compatible with common pistol magazines, including the Glock.

While the 10 mm Auto cartridge has traditionally been somewhat of a rarity in rifles, the recent resurgence in interest in the cartridge has crossed over into the PCC world. Pistol-caliber carbines in 10 mm Auto are now available from companies such as CMMG, KRISS USA, Just Right, TNW and Hi-Point. A 16" barrel wings the maximum performance out of the high-strung 10 mm Auto, with several of the cartridges I tested producing more than 700 ft.-lbs. of muzzle energy. A PCC in 10 mm takes a pistol cartridge into the realm of close-range hunting for medium-size game.

In AR-15 rifle form, though, the 10 mm is still uncommon. While the aforementioned 10 mm PCCs have plenty of room in their receivers to house a bolt with enough mass to handle the pressures developed by the 10 mm cartridge, the AR-15 presents its own problems when trying to fit a blowback system within the confines of a 5.56 mm-sized receiver. Even when chambered in 9 mm, an AR-15-type rifle must be adapted to a blowback action, with extra weight added to the bolt, a reinforced hammer and heavier buffer.

A solution to this problem is offered by Georgia-based Macon Armory. Known for its AR-45 .45 ACP AR-15 conversions, Macon builds an upper chambered in 10 mm Auto that is a locked-breech design with direct-impingement (DI) gas operation. Starting with a standard upper receiver, that includes a forward assist, a case deflector and a dustcover, Macon modifies a standard AR bolt and carrier to accommodate the 10 mm cartridge. Under the upper's free-float handguard, a low-profile gas block routes a custom-length gas tube back into the receiver. The system works exactly like a standard rifle-caliber AR-15. When a cartridge is fired, a small amount of gas is bled off the barrel. It travels back the gas tube into the receiver where it causes the carrier to move rearward, unlocking the multi-lug, rotating bolt.



recommends pairing its upper with an Angstadt Arms lower. We followed its advice, sourcing Angstadt's large-frame, Glock-magazine-compatible 1045 lower receiver. The billet receiver comes stripped, except for its proprietary parts, including the magazine release and bolt hold-open lever. We completed the build with a standard AR-15 lower parts kit and a VLTOR EMOD stock. Because of its direct-impingement operation, the Macon Armory upper is compatible with standard AR hammers and a carbine-weight buffer system.

**ANGSTADT ARMS/MACON ARMORY SHOOTING RESULTS (50 YDS.)**

10 MM AUTO CARTRIDGE	VEL. @ 10' (F.P.S.)	ENERGY (FT.-LBS.)	GROUP SIZE (INCHES)		
			SMALLEST	LARGEST	AVERAGE
<b>BUFFALO BORE HEAVY 200-GR. FMJ</b>	1268 Avg. 18 Sd	714	1.75	2.37	2.09
<b>CCI BLAZER BRASS 180-GR. FMJ</b>	1322 Avg. 13 Sd	698	1.09	1.84	1.53
<b>FEDERAL PREMIUM HST 200-GR. JHP</b>	1151 Avg. 18 Sd	588	1.58	2.24	1.84
<b>AVERAGE EXTREME SPREAD</b>					1.82

NOTES: MEASURED AVERAGE VELOCITY FOR 10 SHOTS OVER A COMPETITION ELECTRONICS PROCHRONO DIGITAL CHRONOGRAPH AT 10 FT. ACCURACY RESULTS FOR FIVE CONSECUTIVE, FIVE-SHOT GROUPS AT 50 YDS. FROM A CALDWELL MATRIX REST. TEMPERATURE: 67° F. HUMIDITY: 72%. ABBREVIATIONS: FMJ (FULL METAL JACKET), JHP (JACKETED HOLLOW POINT), Sd (STANDARD DEVIATION).

Pistol-caliber AR-15s bring many advantages to the PCC world. They combine the familiarity of America's most popular rifle with DIY-friendly aftermarket support. Toss in the 10 mm cartridge and our Macon Armory/Angstadt Arms build pushes AR PCC performance to the max.

**ANGSTADT ARMS/MACON ARMORY 10 mm DI**

MANUFACTURER: ANGSTADT ARMS (DEPT. AR), 701 ATAMCO AVE., SUITE E, CHARLOTTE, NC 28206; (704) 200-9352; ANGSTADTARMS.COM  
 MACON ARMORY (DEPT. AR), 2970 McMANUS ROAD, MACON, GA 31220; (478) 474-2990; MACONARMORY.COM

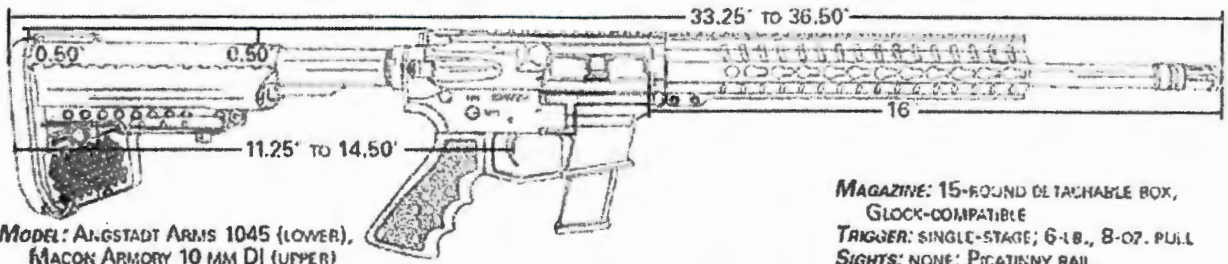

**MODEL:** ANGSTADT ARMS 1045 (LOWER),  
 MACON ARMORY 10 MM DI (UPPER)  
**ACTION TYPE:** GAS-OPERATED,  
 SEMI-AUTOMATIC, CENTER-FIRE RIFLE  
**CHAMBERING:** 10 MM AUTO  
**RECEIVER:** 7075-T6 ALUMINUM ALLOY;  
 HARD-ANODIZED

**STOCK:** POLYMER  
**BARREL:** 4140 CHROME-MOLY STEEL; MUZZLE  
 THREADED 5/8X24 TPI; SIX-GROOVE,  
 1:16" RH TWIST

**MAGAZINE:** 15-ROUND DETACHABLE BOX,  
 GLOCK-COMPATIBLE  
**TRIGGER:** SINGLE-STAGE; 6-LB., 8-OZ. PULL  
**SIGHTS:** NONE; PIGATINNY RAIL  
**WEIGHT:** 6 LBS., 10 OZS.  
**ACCESSORIES:** N/A  
**MSRP:** \$325 (UPPER), \$279 (LOWER)  
 \$140 (LOWER PARTS), \$115 (STOCK)  
 Total \$1,459

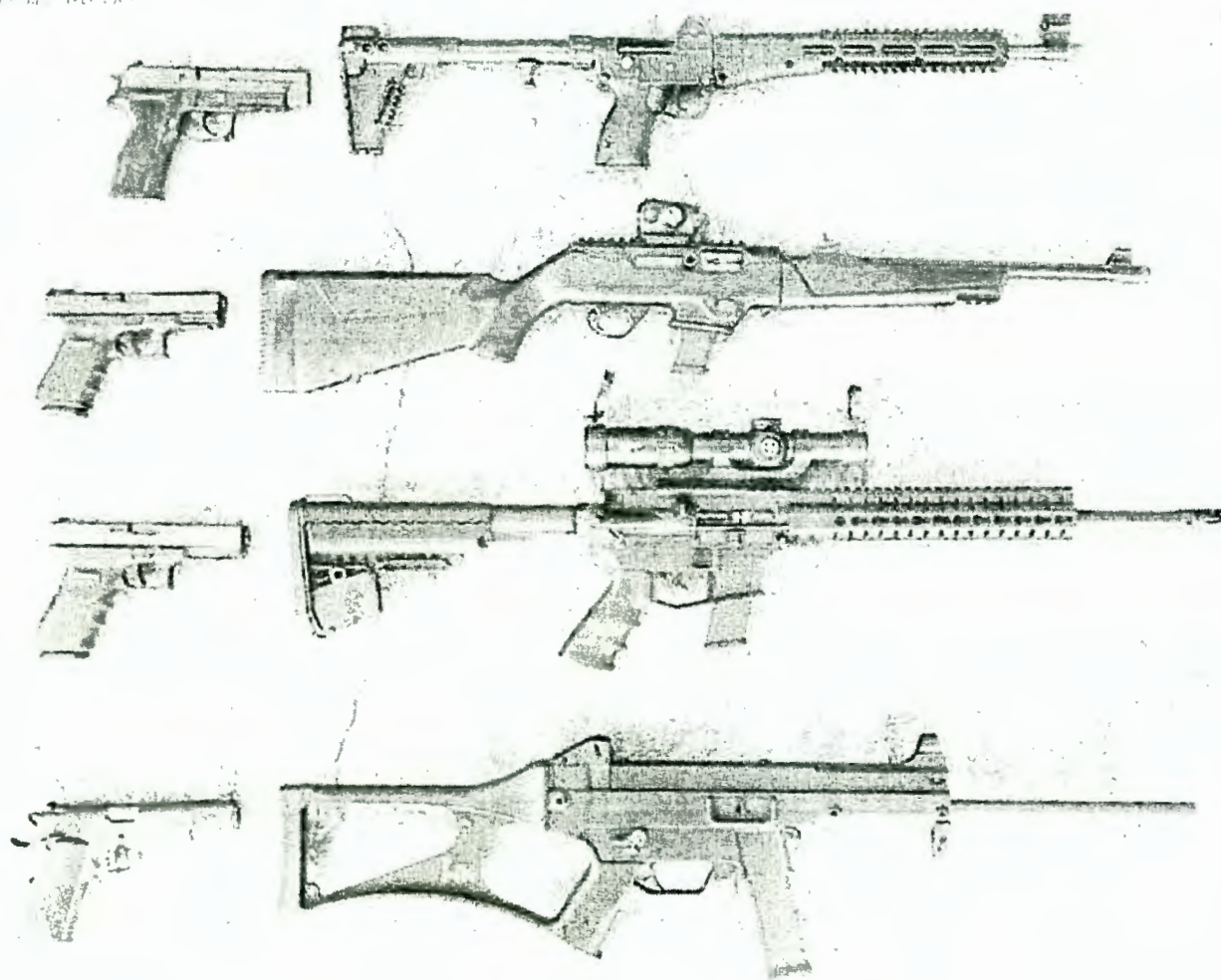

**PISTOL CALIBER CARBINE TEST - RIFLE VS. PISTOL VELOCITY AND ENERGY COMPARISON**

CARTRIDGE	FIREARM	BARREL LENGTH (INCHES)	VEL. @ 10' (F.P.S.)	VELOCITY DIFFERENCE	ENERGY (FT.-LBS.)	ENERGY DIFFERENCE
9 MM LUGER WINCHESTER FORGED 115-GR. FMJ	GLOCK MODEL 17	4.5	1146 AVG.		336	
	KEL-TEC SUB-2000	16.25	1318 AVG.	172 F.P.S. (15.01%)	444	108 FT.-LBS. (32.14%)
.40 S&W AGUILA 180-GR. FMJ	SIG SAUER P226	4.4	1025 AVG.		421	
	RUGER PC CARBINE	16.20	1155 AVG.	130 F.P.S. (12.68%)	533	112 FT.-LBS. (26.60%)
10 LHM AUTO CCI BLAZER BRASS 180-GR. FMJ	GLOCK MODEL 20	4.6	1115 AVG.		497	
	ANGSTADT ARMS/MACON ARMORY DIAR-15	16.00	1322 AVG.	207 F.P.S. (18.57%)	698	201 FT.-LBS. (40.44%)
.45 ACP WINCHESTER USA READY 230-GR. FMJ	GLOCK MODEL 21	4.6	845 AVG.		365	
	HECKLER & KOCH USC	16.00	1000 AVG.	155 F.P.S. (18.34%)	511	146 FT.-LBS. (40.00%)

MEASURED AVERAGE VELOCITY FOR 10 ROUNDS USING A COMPETITION ELECTRONICS PROCHRON3 DIGITAL CHRONOGRAPH.

**Conclusion**

Nearly 150 years after Colt decided to chamber its famed Frontier Six-Shooter in the .44-40 round used by Winchester's Model 1873, pistol-caliber carbines still offer many of the same advantages. Pistol-caliber long guns are an affordable, compact, lightweight and low-recoiling option when compared with carbines or rifles chambered for rifle cartridges. In addition, they offer greater effective accuracy and increased power over a handgun chambered for the same cartridge. In times when some

© Copyright 2023 National Rifle Association

One rifle, one handgun, one cartridge.

home defense, plinking or competitive shooting, pistol-caliber carbines represent a practical choice.

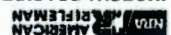



tabbles®  
EXHIBIT  
I

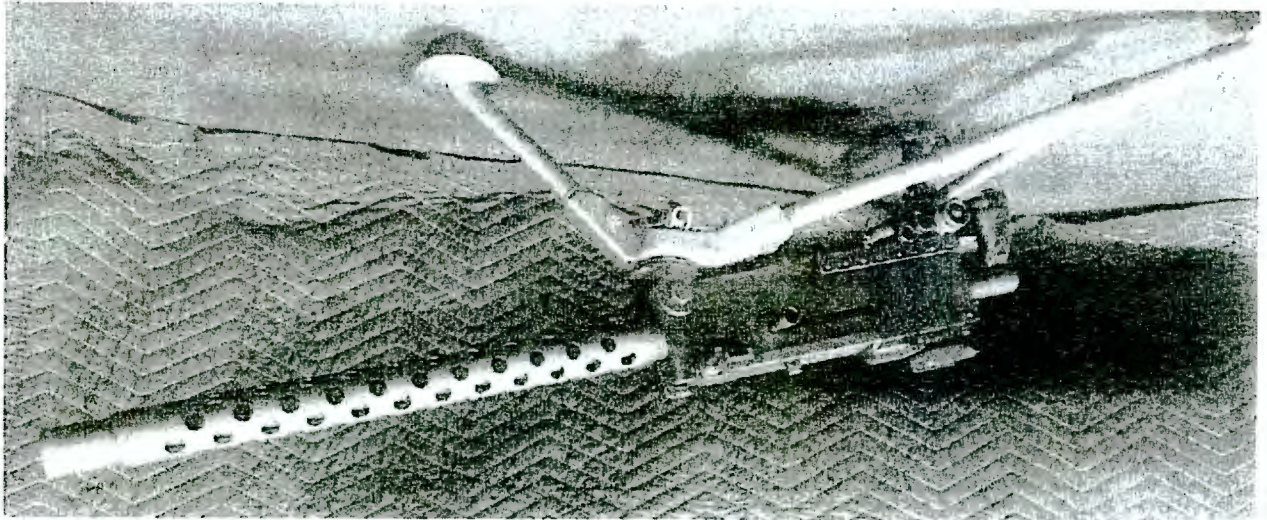
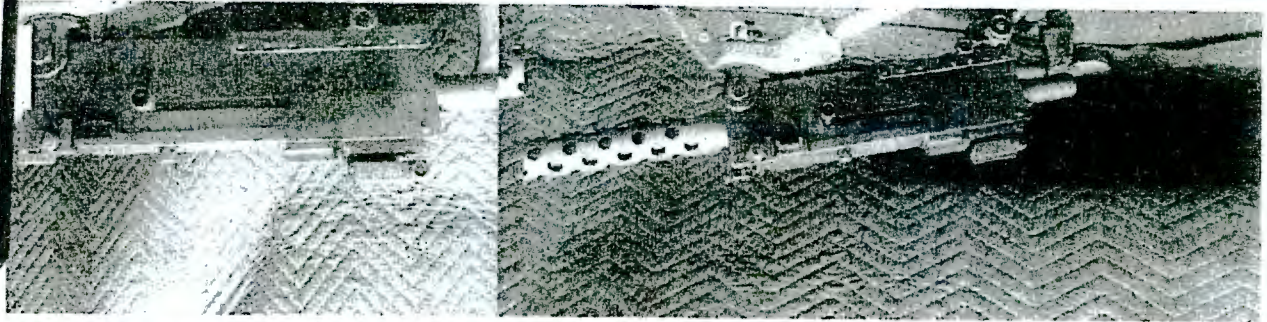

(C)

1919a4-a6 for sale





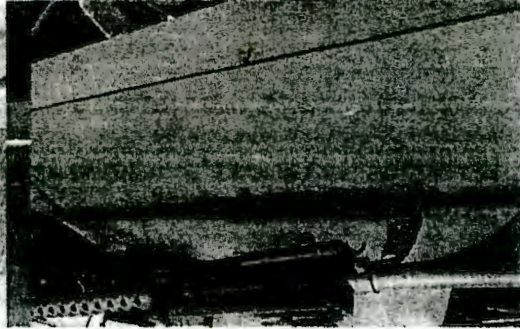
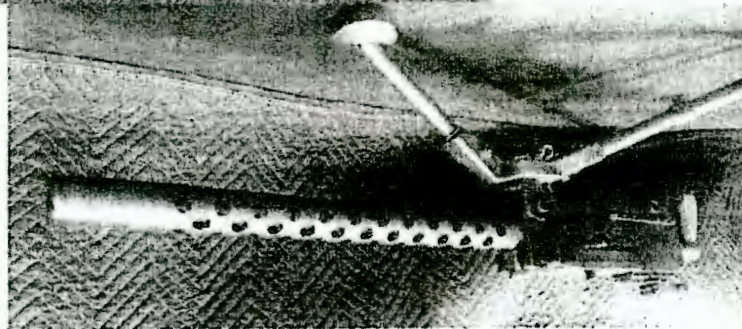
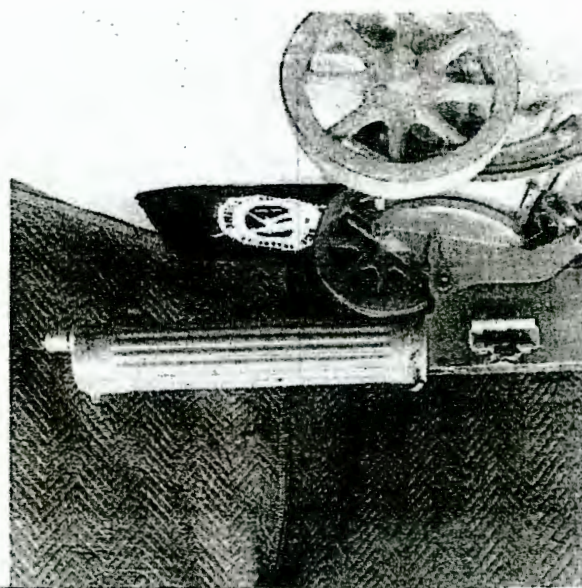
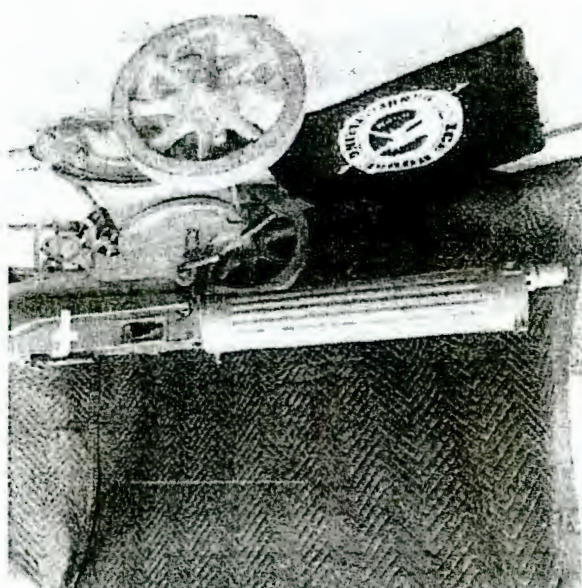



# Exhibit A-3



10/1/23, 10:38 AM

ARX 100 | Tactical Military 5.56 & .223 Caliber Rifle | Beretta

COUNTRY UNITED STATES

CUSTOMER SERVICE SIGN IN | REGISTER



Search Beretta



FIREARMS

GUN ACCESSORIES

CLOTHING

GUN CASES

MILITARY & LE

COMPANY

SALE

Home | Firearms | ARX 100



EXCLUSIVE OFFER



[Read Reviews](#)

# ARX 100

The ARX100 is the ultimate evolution of the modern tactical semiauto rifle. Find out more about its fully-ambidextrous operation, tool-free disassembly—plus the sort of flawless reliability that make it perfect for the most demanding tactical shooter. [Read Less](#)

BUY NOW



Model Code	JXR11B00
Model Name	ARX 100

<https://www.beretta.com/en-us/arx-100/>



10/1/23, 10:38 AM

ARX 100 | Tactical Military 5.56 & .223 Caliber Rifle | Beretta

MSRP	\$ 1950.00
Caliber	5.56 /223 REM
Rounds	30RDS

ARX 100

Action	Semi-auto
Barrel length (mm)	406
Barrel length (in)	16
Caliber	5.56
Historical	N
Magazine	30
Overall height (mm)	215
Overall height (in)	8.5
Overall length (mm)	908
Overall length (in)	35.75
Overall width (mm)	70
Overall width (in)	2.75
RateOfTwist	1/7
SightRadiusIN	15
SightRadiusMM	381
Sights	Removable/Adjustable
Weight unloaded (g)	3080
Weight unloaded (OZ)	108.8

BUY NOW

### Find a dealer

Locate a Beretta Dealer closest to you.

Enter Zip Code

25 miles

SEARCH BERETTA

REGISTER YOUR FIREARM

DOWNLOAD A PRODUCT MANUAL

CHECK REPAIR STATUS

EXCLUSIVE OFFER

## ARX100: Today's Ultimate Tactical Rifle

The ARX100 was engineered with one purpose in mind: to be today's best tactical semiauto rifle.



It takes the concept of a modular rifle to futuristic levels, while maintaining an absolutely simple operation that make it ultra-reliable. With ambidextrous controls, easily-replaceable barrel and virtually endless possibilities for [customization and accessorization](#), the ARX100 is adaptable to any firing scenario and is perfect for today's most demanding tactical shooter.



### Ultimate Reliability and Ease of Maintenance

The ARX100 features a constant contact/short-stroke gas piston system that makes it feed and fire under the most unforgiving conditions. The lightweight technopolymer receiver allows for reliable operation with virtually no lubricants. To make maintenance easy and trouble-free, this rifle has no pins and can be completely disassembled in a matter of seconds with no tools at all.

### Ultimate Versatility

This rifle was designed to be completely ambidextrous, and all the critical controls on it may be operated right- or left-handed. These include the 2-position safety, the [magazine](#) release, the bolt release and charging handle and the case-ejection selector, which determines whether spent brass is ejected to the right or left. The flip-up backup sights that come standard on the ARX100 are also versatile, offering an easily-adjustable diopter system ranged from 100 to 800 yards. The barrel is also easily replaceable in seconds, making it possible to use different lengths and calibers without any tools required. Lastly, the folding stock is adjustable for length of pull at the touch of a button, using a simple and rugged telescopic construction.



### Ultimate Accessorization

The possibilities for accessorization on the ARX100 are limited only by the user's imagination. It comes out of the box with a full-length Picatinny rail on top, which is perfect for attaching a variety of optics and other sighting systems. It also has Picatinny rails on both sides of and under the fore-end, which offer countless possibilities for easily adding lighting systems and other tactical devices.

[Also available in a .22LR version.](#)

## Customer Reviews



10/1/23, 10:38 AM

ARX 100 | Tactical Military 5.56 & .223 Caliber Rifle | Beretta

# Average Rating

Based on 21 reviews

- 81% Rated this
- 10% Rated this
- 5% Rated this
- 5% Rated this
- 0% Rated this

[WRITE A REVIEW](#)

| 52% would recommend this item to a friend.

Sort: Most Helpful First

1 2 3 4 5 6 7 of 11 [Read all 21 reviews](#)

J John

11/22/2020 - 11:54 PM

[Report Abuse](#)

94 out of 98 people found the following review helpful

## Excellent rifle

I sure love this rifle, I just wish Beretta actually supported it. Where are the caliber conversions and other new accessories? Have you abandoned it completely?

[Comment](#) | Was this review helpful? [Yes](#) | [No](#)

M Mark

7/24/2021 - 3:34 PM

[Report Abuse](#)

119 out of 158 people found the following review helpful

## ARX 100

You have pictures that show people with a 10.5" Barrel but don't offer a 10.5" barrel. You say Ultimate Accessorization but offer no accessories. Where's the 300 BLK out barrel? Shame on Beretta for alienating it's customers like this

[Comment](#) | Was this review helpful? [Yes](#) | [No](#)

Sort: Most Helpful First

1 2 3 4 5 6 7 of 11 [Read all 21 reviews](#)

## RECOMMENDED PRODUCTS



Tactical Range Bag  
\$149.00



Beretta Universal Gun Cleaning Kit  
\$60.00



Beretta Enlarged Cocking Handle for mod. ARX 100 & ARX 160  
\$20.00



Beretta Lower Picatinny Rail for Beret ARX100  
\$32.00

EXCLUSIVE OFFER



FIREARMS

CUSTOMER SERVICE

COMPANY



10/1/23, 10:38 AM

ARX 100 | Tactical Military 5.56 & .223 Caliber Rifle | Beretta

FOLLOW US

STAY INFORMED

© Beretta USA | Site designed and developed by Americansage.com  
Terms & Conditions | Privacy Policy | Do Not Sell My Info - CA Residents | CA Privacy Rights | CA Transparency in Supply Chain Act | Website Accessibility Statement | User Submissions | Site Map

- Pistols
- Shotguns
- Rifles
- User Manuals
- Dealer Locator
- Warranty Activation
- Returns
- Order History
- Contact Us
- Galleries
- Careers
- Team Beretta
- Affiliate Program
- Deals & Promotions
- Blog
- Events
- Sitemap

SIGN UP FOR NEWS & UPDATES



# Exhibit A-4

DEPOSITION  
EXHIBIT  
4

PDP - www.waltherarms.com

waltherarms.com/pdp

WALHER HOME PARTS ACCESSORIES JOURNAL CONTACT

ACCOUNT SEARCH



It's our duty to build the best performing firearm

**IT'S YOUR DUTY  
TO BE READY**



GUNS AND AMMO: "2021 HANDGUN OF THE YEAR!"



INDUSTRY CHOICE AWARDS: "2021 HANDGUN OF THE YEAR!"



Type here to search

Taskbar icons: File Explorer, Calendar, Edge, Chrome, Word, Teams

System tray: USOIL -2.20%, 1:10 PM, 9/28/2023



**PDP COMPACT**

	Compact 4"
Item #	2851229
Magazine Capacity	17 Rounds
Magazines Included	2
Caliber	9mm
MSRP	\$699.00
10 Round Item #	2854686



**PDP FULL SIZE 4"**

	Full-Size 4"
Item #	2851237
Magazine Capacity	18 Rounds
Magazines Included	2
Caliber	9mm
MSRP	\$699.00
10 Round Item #	2854694



**PDP FULL SIZE 4.5"**

	Full-Size 4.5"
Item #	2842475
Magazine Capacity	18 Rounds
Magazines Included	2
Caliber	9mm
MSRP	\$699.00
10 Round Item #	2858126



### PDP COMPACT 5"



### PDP FULL-SIZE 5"



### PDP PRO SD COMPACT 4"



	Compact 5"
Item #	2844272
Magazine Capacity	5 Rounds
Magazines Included	2
Caliber	9mm
MSRP	\$699.00
10 Round Item #	2858151

	Full-Size 5"
Item #	2844001
Magazine Capacity	18 Rounds
Magazines Included	2
Caliber	9mm
MSRP	\$699.00
10 Round Item #	2858134

	PDP PRO SD COMPACT 4"
Item #	2844176
Magazine Capacity	18 Rounds
Magazines Included	3
Caliber	9mm
MSRP	\$849.00
10 Round Item #	2854686

PDP Full-Size 9mm 10-Round



waltherarms.com/walther-pdp-full-size-mag-9mm-10rd-dimpled



## WALTHER PDP FULL SIZE MAG 9MM 10RD DIMPLED

10 round magazine that fits the PDP Full Size handgun.  
Not legal for sale in California, Washington or  
Connecticut. Do not use without adhering to PDP handgun  
20+round 9mm PDP process and correct magazine design for safe  
operation.  
Available exclusively to the North American Market.

ADD TO CART



Type here to search

# Exhibit A-5



# Shooter's Bible<sup>®</sup> 114<sup>th</sup> EDITION

THE WORLD'S BESTSELLING  
FIREARMS REFERENCE



PENGILLO-BRYAN, N. J.  
DEPOSITION  
EXHIBIT  
5

- PHOTOS, SPECIFICATIONS, AND PRICES
- HUNDREDS OF RIFLES, SHOTGUNS, AND HANDGUNS
- SIGHTS, SCOPES, AND AMMUNITION
- DETAILS OF THE NEWEST GUNS AND OPTICS—IN COLOR
- COMPREHENSIVE BALLISTICS SECTION

**MORE  
THAN  
7 MILLION  
COPIES  
SOLD**



Copyright © 2022 by Skyhorse Publishing, Inc.

All rights reserved. No part of this book may be reproduced in any manner without the express written consent of the publisher, except in the case of brief excerpts in critical reviews or articles. All inquiries should be addressed to Skyhorse Publishing, 307 West 36th Street, 11th Floor, New York, NY 10018.

Skyhorse Publishing books may be purchased in bulk at special discounts for sales promotion, corporate gifts, fund-raising, or educational purposes. Special editions can also be created to specifications. For details, contact the Special Sales Department, Skyhorse Publishing, 307 West 36th Street, 11th Floor, New York, NY 10018 or [info@skyhorsepublishing.com](mailto:info@skyhorsepublishing.com).

Skyhorse® and Skyhorse Publishing® are registered trademarks of Skyhorse Publishing, Inc.®, a Delaware corporation.

Visit our website at [www.skyhorsepublishing.com](http://www.skyhorsepublishing.com).

10 9 8 7 6 5 4 3 2 1

Library of Congress Cataloging-in-Publication Data is available on file.

Cover design by Brian Peterson  
Cover photos courtesy of Franchi Firearms, Kimber America,  
and AREX Defense

Print ISBN: 978-1-5107-7318-9  
Ebook ISBN: 978-1-5107-7319-6  
ISSN: 0080-0635

Printed in the United States of America

Note: Every effort has been made to record specifications and descriptions of guns, ammunition, and accessories accurately, but the Publisher can take no responsibility for errors or omissions. The prices shown for guns, ammunition, and accessories are manufacturers' suggested retail prices (unless otherwise noted) and are furnished for information only. These were in effect at press time and are subject to change without notice.



# CONTENTS



<b>INTRODUCTION</b>	<b>4</b>
<b>GUNS, OPTICS, AND AMMO 2023</b>	<b>6</b>
<b>NEW PRODUCTS</b>	<b>12</b>
RIFLES	13
AIRGUNS	36
SHOTGUNS	42
HANDGUNS	53
OPTICS	81
AMMUNITION	104
<b>CURRENT PRODUCTS</b>	<b>113</b>
RIFLES	113
AIRGUNS	229
SHOTGUNS	254
HANDGUNS	318
BLACK POWDER	425
OPTICS	437
AMMUNITION	493
<b>REFERENCE</b>	<b>555</b>
BALLISTICS	555
GUNFINDER INDEX	603



# Benelli USA



**BENELLI R1 PRO BIG GAME**

### R1 PRO BIG GAME

**Action:** Semiautomatic  
**Stock:** Walnut  
**Barrel:** 22 in.  
**Sights:** Fiber optic front, adjustable rear  
**Weight:** 7 lb. 3.2 oz.  
**Caliber:** .30-06 Spfd.

**Magazine:** 4 rounds  
**Features:** Includes Benelli's Progressive Comfort technology; AA walnut satin finish stock; receiver drilled and tapped for scope mount, Picatinny rail and shim kit included; CRIO treated barrel  
**MSRP**..... \$1499.00

# Beretta USA



**BERETTA USA ARX100**

### ARX100

**Action:** Semiautomatic  
**Stock:** Telescopic folding  
**Barrel:** 16 in.  
**Sights:** Removable back-up sights  
**Weight:** 6 lb. 13 oz.  
**Caliber:** 5.56 NATO (other barrels available)  
**Magazine:** 30 rounds  
**Features:** Cold hammer forged barrel



**BERETTA CX4 STORM**

### CX4 STORM

**Action:** Single-action  
**Stock:** Synthetic  
**Barrel:** 16.6 in.  
**Sights:** Front sight post  
**Weight:** 5 lb. 12 oz.  
**Caliber:** 9mm  
**Magazine:** 10, 15 rounds  
**Features:** Picatinny rail; allows for reverse ejection and extraction; ideal for left-handed shooters; adjustable length-of-pull; easy to accessorize; takes Beretta series 92 pistol magazines  
**MSRP**.....\$899.00

can be replaced with barrels in different lengths and calibers; case ejection switches from right to left at a button push; completely ambidextrous; technopolymer receiver; contains no pins and can be disassembled without the use of tools; optional .300 Black Out kit available  
**MSRP**.....\$1950.00

RIFLES

# Bergara



**BERGARA B-14 HMR**

### B-14 HMR

**Action:** Bolt  
**Stock:** Bergara BMP HMR molded with mini-chassis  
**Barrel:** 20 in. (.308 Win.), 22 in. (6.5 Creedmoor)  
**Sights:** None  
**Weight:** 9 lb. 2.4 oz.-9 lb. 4 oz.  
**Caliber:** 6.5 Creedmoor, 6.5 PRC, .308 Win., .22-250 Rem., .450 Bushmaster, .300 Win. Mag., .300 PRC  
**Magazine:** 5 rounds  
**Features:** Field or competition use; buttstock has adjustable cheekpiece, and LOP spacers, integrated mini-chassis; one-piece Bergara B-14 action, Bergara Performance trigger, AICS detachable magazine, threaded muzzle and thread protector; left-hand available in 6.5 Creedmoor,

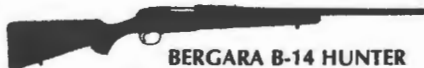

**BERGARA B-14 HUNTER**

.308 Win., .22-250 Rem., and .300 Win. Mag.  
**MSRP**.....\$1249.00

### B-14 HUNTER

**Action:** Bolt  
**Stock:** Glass fiber-reinforced polymer  
**Barrel:** 22 in. (short actions), 24 in. (long actions)  
**Sights:** None  
**Weight:** 7 lb.-7 lb. 2 oz.  
**Caliber:** .30-06 Spfd., .300 Win. Mag., .270 Win., .308 Win., 6.5 Creedmoor, 7mm Rem. Mag., .243 Win., .22-250 Rem., 7mm-08 Rem.  
**Magazine:** 3, 4 rounds  
**Features:** Stock has Soft Touch coating for better purchase; drilled and tapped for Remington 700-style bases; barrel is matte blue  
**MSRP**.....\$899.00

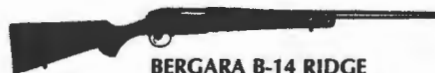

**BERGARA B-14 RIDGE**

### B-14 RIDGE

**Action:** Bolt  
**Stock:** Glass fiber-reinforced polymer  
**Barrel:** 18, 22, 24 in.  
**Sights:** None  
**Weight:** 7 lb. 3 oz.-7 lb. 15 oz.  
**Caliber:** 6.5 Creedmoor, 6.5 PRC, .308 Win., .243 Win., .22-250 Rem., 7mm-08 Rem., .450 Bushmaster, .270 Win., .30-06 Spfd., 7mm Rem. Mag., .300 Win. Mag., .300 PRC  
**Magazine:** 3, 4 rounds  
**Features:** Stock has Soft Touch coating for better purchase; drilled and tapped for Remington 700-style bases; barrel is a #5 profile of 4140 CrMo steel in matte blue and threaded for suppressor or muzzle brake use; choice of hinged floor plate or detachable magazine; .308 and 6.5 Creedmoor available in an 18-inch Special Purpose Short Barrel  
**MSRP**.....\$949.00



# Franklin Armory



FRANKLIN ARMORY  
BSFIII M4



FRANKLIN ARMORY M4-HTF  
R3 XTD

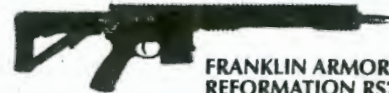

FRANKLIN ARMORY  
REFORMATION RS7, RS11



FRANKLIN ARMORY  
XO-26 R3

## BSFIII M4

**Action:** Semiautomatic  
**Stock:** Synthetic  
**Barrel:** 16 in.  
**Sights:** None  
**Weight:** N/A  
**Caliber:** 5.56 NATO  
**Magazine:** 20 rounds  
**Features:** Franklin's Binary Firing System Gen III, a 3-position trigger: Position 1 is safe, position 2 is one shot per pull, and position 3 fires one round on pull and one on release; LTW contour barrel; 15-in. FST handguard; standard charging handle; mid-length gas system; low-profile gas block; A2 flash hider and grip; M4 stock  
**MSRP**.....\$1109.99

## M4-HTF R3 XTD

**Action:** Semiautomatic  
**Stock:** Synthetic  
**Barrel:** 16 in.

**Sights:** None  
**Weight:** N/A  
**Caliber:** 5.56 NATO, .350 Legend  
**Magazine:** 20 rounds  
**Features:** Binary Firing System Gen III, a 3-position trigger: position 1 is safe, position 2 is one shot per pull, and position 3 fires one round on pull and one on release; LTW contour barrel; 15-in. FSR M-LOK handguard; mil-spec charging handle; mid-length gas system; low-profile gas block; Aura XTD muzzle device; B5 grip; B5 Bravo stock  
**MSRP**..... \$1259.99-\$1369.99

## REFORMATION RS7, RS11

**Action:** Semiautomatic  
**Stock:** Synthetic  
**Barrel:** 7.5 in., 11.5 in.  
**Sights:** MBUS  
**Weight:** N/A  
**Caliber:** 5.56 NATO, .300 BLK  
**Magazine:** 20 rounds  
**Features:** The Reformation barrel does not impart spin on the projectile, so it does not meet the definition of 'rifling.' Franklin Armory has safely

tested off-the-shelf ammunition in a Reformation barrel and routinely achieved 3.5 in. @100 yards with white box ammunition. .300 BLK has 11.5-in. barrel and choice of black or OD green receiver; 5.56 NATO has 7.5-in. barrel and is available in black; both calibers can option Franklin Armory's Binary Firing System Gen III trigger  
**RS7:**..... \$1254.99-\$1429.99  
**RS-11:**..... \$1594.99-\$1757.99

## XO-26 R3

**Action:** Semiautomatic  
**Stock:** Synthetic  
**Barrel:** 12 in.  
**Sights:** None  
**Weight:** N/A  
**Caliber:** 5.56 NATO, .350 Legend  
**Magazine:** 10, 30 rounds  
**Features:** Barrel has an LTW contour; 11.5-in. FST handguard; standard charging handle; pistol lower; BFSIII or custom-tuned trigger; carbine-length gas system; low-profile gas block; Triumvir muzzle device; Magpul SL grip; Magpul M-LOK MVG  
**MSRP**..... \$1369.99-\$1519.99

RIFLES

# Heckler & Koch



HECKLER & KOCH  
MR556A1

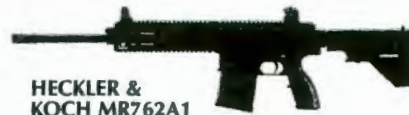

HECKLER &  
KOCH MR762A1



HECKLER & KOCH MR762A1  
LONG RIFLE PACKAGE II

## MR556A1

**Action:** Semiautomatic  
**Stock:** Synthetic  
**Barrel:** 14 in., 16.5 in.  
**Sights:** Troy micro sights  
**Weight:** 8 lb. 10 oz.  
**Caliber:** 5.56 NATO  
**Magazine:** Detachable box, 30 rounds  
**Features:** Free-floating Picatinny rail; gas operated piston system  
**MSRP**.....\$3499.00

**Magazine:** Detachable box, 10, 20 rounds  
**Features:** Match rifle features; direct descendant of HK416/417 series, but made for civilians; uses a piston and a solid operating "pusher" rod in place of the common gas tube normally used in AR-style rifles; cold-hammer-forged barrel; adjustable stock  
**MSRP**.....\$3999.00

**Caliber:** 7.62 NATO  
**Magazine:** Detachable box, 10, 20 rounds  
**Features:** Semi-auto descendent of the full-auto HK416/417; short-stroke gas piston; cold hammer-forged barrel; adjustable cheekpiece; Long Rifle Package adds an a buttstock with an adjustable cheekpiece, LaRue Tactical BRM-S bipod, a second magazine, MLOK handguard, hard case, and Vortex Viper PSTII 3-15X44mm first focal plane MRAD scope  
**Standard**.....\$4129.00  
**Package**.....\$7249.00

## MR762A1

**Action:** Semiautomatic  
**Stock:** Synthetic  
**Barrel:** 16.5 in.  
**Sights:** None  
**Weight:** 9 lb. 15 oz.  
**Caliber:** 7.62 NATO

## MR762A1 LONG RIFLE PACKAGE II

**Action:** Semiautomatic  
**Stock:** Synthetic  
**Barrel:** 16.5 in.  
**Sights:** 3-9x40mm scope  
**Weight:** 10 lb. 7 oz.



# Ruger (Sturm, Ruger & Co.)

RIFLES



RUGER 10/22 CARBINE

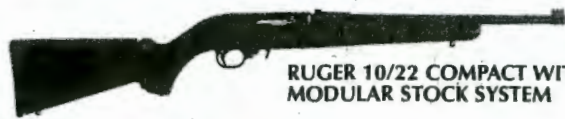

RUGER 10/22 COMPACT WITH MODULAR STOCK SYSTEM



RUGER 10/22 TAKEDOWN



RUGER 10/22 TAKEDOWN WITH MAGPUL BACKPACKER STOCK



RUGER 10/22 TARGET



RUGER 77/17

## 10/22 CARBINE

**Action:** Semiautomatic  
**Stock:** Synthetic or hardwood  
**Barrel:** 18.5 in.  
**Sights:** Gold bead front sight, adjustable rear  
**Weight:** 5 lb.  
**Caliber:** .22 LR  
**Magazine:** Detachable rotary, 10 rounds  
**Features:** Available versions come in wood, black, gray or Go Wild Rock Star camo synthetic stocks with blue metalwork or a black synthetic stock with stainless steel hardware; extended magazine release; hammer-forged barrel; polymer trigger housing; aluminum receiver; contoured butt pad; barrel band; modular stock version has topside Picatinny rail  
**Wood, black synthetic:** . . . . \$379.00  
**Gray synthetic** . . . . . \$369.00  
**Black synthetic/ stainless:** . . . . . \$419.00  
**Wood, black synthetic with scope:** . . . . . \$439.00  
**Go Wild Rock Star camo:** . . \$429.00

## 10/22 COMPACT WITH MODULAR STOCK SYSTEM

**Action:** Semiautomatic  
**Stock:** Synthetic  
**Barrel:** 16.12 in.  
**Sights:** Adjustable fiber optic rear, fiber optic front  
**Weight:** 4 lb. 9 oz.  
**Caliber:** .22 LR  
**Magazine:** 10 rounds  
**Features:** The rugged, reliable 10/22 now with a Modular Stock System;

low comb and short length of pull  
**MSRP** . . . . . \$369.00

## 10/22 TAKEDOWN

**Action:** Semiautomatic  
**Stock:** Black synthetic  
**Barrel:** 16.12 in.-18.5 in.  
**Sights:** Gold bead front, adjustable rear  
**Weight:** 4 lb. 9.6 oz.-5 lb. 5 oz.  
**Caliber:** .22 LR  
**Magazine:** Detachable rotary, 10 rounds  
**Features:** Built of alloy steel with satin black finish; easy takedown and reassembly; detachable rotary magazine; extended magazine release; available in three configurations: black synthetic stock with 18.5-in. stainless barrel; black synthetic stock with 16.4-in. threaded barrel with flash suppressor in blue; black synthetic Ruger modular stock with 16.12-in. satin black threaded, fluted target barrel  
**Stainless:** . . . . . \$539.00  
**Blued with flash suppressor:** . . . . . \$559.00  
**Blued threaded/fluted:** . . . \$769.00

## 10/22 TAKEDOWN WITH MAGPUL BACKPACKER STOCK

**Action:** Semiautomatic  
**Stock:** Synthetic  
**Barrel:** 16.4 in.  
**Sights:** Fiber optic front and rear  
**Weight:** 4 lb. 3 oz.  
**Caliber:** .22 LR  
**Magazine:** 10 rounds  
**Features:** A new configuration in the

10/22 breakdown family that wears a Magpul X-22 Backpacker stock in Stealth Gray; threaded stainless barrel  
**MSRP** . . . . . \$529.00

## 10/22 TARGET

**Action:** Semiautomatic  
**Stock:** Laminate  
**Barrel:** 16.13 in.  
**Sights:** None  
**Weight:** 5 lb.  
**Caliber:** .22 LR  
**Magazine:** 10 rounds  
**Features:** Laminated thumbhole stock adjustable for length of pull; vented forearm; cold hammer-forged barrel; scope base adapter that works with Weaver-style and .22 tip-off mounts; metal has a satin blue finish  
**MSRP** . . . . . \$769.00

## 77/17

**Action:** Bolt  
**Stock:** Walnut  
**Barrel:** 20 in.  
**Sights:** None  
**Weight:** 5 lb. 11 oz.  
**Caliber:** .17 WSM, .17 Hornet  
**Magazine:** 6 rounds  
**Features:** Traditionally styled small-bore for varmint or target work with: detachable rotary magazine; sling swivel studs; integral scope mounts; three-position safety; both calibers available in Green Mountain laminate stock, .17 WSM also available in American walnut  
**MSRP** . . . . . \$1209.00-\$1309.00



# Ruger (Sturm, Ruger & Co.)

RIFLES



RUGER AMERICAN RIFLE



RUGER AMERICAN RIFLE HUNTER

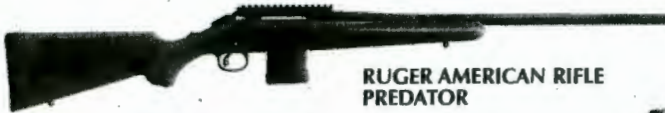

RUGER AMERICAN RIFLE PREDATOR



RUGER AMERICAN RIFLE RANCH



RUGER AMERICAN RIFLE WITH GO WILD CAMO



RUGER AMERICAN RIFLE WITH VORTEX RIFLESCOPE

## AMERICAN RIFLE

**Action:** Bolt  
**Stock:** Synthetic  
**Barrel:** 22 in.  
**Sights:** Drilled and tapped for scopes  
**Weight:** 6 lb. 2 oz.–6 lb. 4 oz.  
**Caliber:** .22-250 Rem., .223 Rem., 6.5 Creedmoor, 7mm-08 Rem., .243 Win., .270 Win., .30-06 Spfd., .308 Win.  
**Magazine:** Detachable rotary, 4 rounds  
**Features:** Ruger Marksman adjustable trigger; ergonomic, lightweight stock; soft rubber recoil pad; three-lug 70 degree bolt; Power Bedding positively locates the receiver and free-floats the barrel; hammer-forged barrel; tang safety; round rotary magazine  
**MSRP** .....\$579.00

## AMERICAN RIFLE HUNTER

**Action:** Bolt  
**Stock:** Synthetic  
**Barrel:** 20 in.  
**Sights:** None  
**Weight:** 9 lb. 3 oz.  
**Caliber:** 6.5 Creedmoor, .308 Win.  
**Magazine:** 5 rounds  
**Features:** This long-range-game rifle gets a Magpul Hunter American short-action adjustable stock; Ruger Marksman Adjustable trigger  
**MSRP** .....\$989.00

## AMERICAN RIFLE PREDATOR

**Action:** Bolt  
**Stock:** Synthetic  
**Barrel:** 22 in.  
**Sights:** None  
**Weight:** 6 lb. 9 oz.

**Caliber:** .22-250 Rem., 6.5 Creedmoor, .308 Win., .243 Win., 7mm-08 Rem., 6.5 Grendel, .223 Rem., 6mm Creedmoor, .204 Ruger  
**Magazine:** 10 rounds  
**Features:** Moss Green synthetic stock; Ruger Marksman Adjustable Trigger and Power Bedding; threaded barrel; unscoped model has installed Picatinny rail; scoped model comes with a Vortex Crossfire II 4-12x44mm scope factory mounted and the Dead-Hold BDC reticle; left-hand version available  
**Rifle only:** ..... \$599.00–\$679.00

## AMERICAN RIFLE RANCH

**Action:** Bolt  
**Stock:** Synthetic  
**Barrel:** 16.1 in.  
**Sights:** None  
**Weight:** 6 lb.–6 lb. 8 oz.  
**Caliber:** 5.56 NATO, .300 BLK, .450 Bushmaster, 7.62x39, .350 Legend, 6.5 Grendel  
**Magazine:** Detachable rotary, 3–5 rounds  
**Features:** Ruger Marksman Adjustable trigger offers a pull weight that is adjustable between 3 and 5 pounds; ergonomic, lightweight flat dark earth composite stock with modern forend contouring and grip serrations and swivel studs; soft rubber recoil pad; Power Bedding positively locates the receiver and free-floats the barrel for outstanding accuracy; threaded barrel is cold hammer-forged; tang safety; rotary magazine; factory installed one-piece aluminum scope rail  
**MSRP** .....\$659.00

## AMERICAN RIFLE WITH GO WILD CAMO

**Action:** Bolt  
**Stock:** Synthetic  
**Barrel:** 22 in.  
**Sights:** None  
**Weight:** 6 lb. 9 oz.  
**Caliber:** 7mm-08 Rem., .243 Win., 6.5 Creedmoor, .308 Win., .30-06 Spfd., .450 Bushmaster, .300 Win. Mag., .350 Legend, .25-06 Rem., 6.5 PRC  
**Magazine:** 3 rounds  
**Features:** Go Wild I-M Brush camo; action and barrel in Bronze Cerakote; Picatinny rail; muzzle brake; Ruger's Marksman Adjustable Trigger and Power Bedding  
**MSRP** .....\$769.00

## AMERICAN RIFLE WITH VORTEX SCOPE

**Action:** Bolt  
**Stock:** Synthetic  
**Barrel:** 22 in.  
**Sights:** None  
**Weight:** 7 lb. 3 oz.  
**Caliber:** .223 Rem., .243 Win., .270 Win., .30-06 Spfd., 6.5 Creedmoor, .204 Ruger  
**Magazine:** 5 rounds  
**Features:** Vortex 3–9x40mm or 4–12x44mm Crossfire II scope (Dead-Head BDC reticle) already mounted; Ruger Marksman Adjustable Trigger and Power Bedding; a cold hammer forged barrel  
**MSRP** ..... \$769.00–899.00



# Ruger (Sturm, Ruger & Co.)



**RUGER AMERICAN RIMFIRE TARGET**



**RUGER AMERICAN RIMFIRE TARGET STAINLESS**

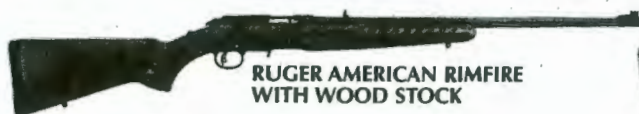

**RUGER AMERICAN RIMFIRE WITH WOOD STOCK**



**RUGER AR-556**



**RUGER AR-556 MPR**



**RUGER AR-556 MPR FLAG SERIES**

## AMERICAN RIMFIRE TARGET

**Action:** Bolt  
**Stock:** Laminate  
**Barrel:** 18 in.  
**Sights:** None  
**Weight:** 6 lb. 8 oz.–6 lb. 11 oz.  
**Caliber:** .17 HMR, .22 LR, .22 WMR  
**Magazine:** 9, 10 rounds  
**Features:** Ruger Marksman Adjustable trigger; aluminum Picatinny rail; cold hammer-forged threaded bull barrel; Power Bedding; flush-fit BX-1 magazines. Variants include GO Wild Camo I-M stocks with burnt bronze Cerakote or black synthetic stocks, some with adjustable stock modules, and blue or stainless metalwork  
**MSRP** ..... \$449.00–\$559.00

## AMERICAN RIMFIRE TARGET STAINLESS

**Action:** Bolt  
**Stock:** Laminate  
**Barrel:** 18 in.  
**Sights:** None  
**Weight:** 6 lb. 11 oz.  
**Caliber:** .22 LR, .22 WMR, .17 HMR  
**Magazine:** 9, 10 rounds  
**Features:** The durability and rust-resistance of a stainless receiver and barrel meet the Ruger American rimfire; flush-mount BX-1 magazine; Ruger Marksman Adjustable trigger; Power Bedding bedding block system  
**MSRP** ..... \$659.00–\$689.00

## AMERICAN RIMFIRE WOOD STOCK

**Action:** Bolt  
**Stock:** Wood  
**Barrel:** 22 in.

**Sights:** Fiber optic front, adjustable rear  
**Weight:** 6 lb. 2 oz.  
**Caliber:** .22 LR  
**Magazine:** 10 rounds  
**Features:** Extended magazine release; patent-pending Power Bedding integral bedding block system; Ruger Marksman Adjustable trigger offers a crisp release with a pull weight that is user adjustable between 3 and 5 lb.; wood stock with checkering on the grip and forend and a rubber butt pad for a comfortable length of pull; cold hammer-forged barrel  
**MSRP** ..... \$569.00

## AR-556

**Action:** Semiautomatic  
**Stock:** Synthetic  
**Barrel:** 16.1 in.  
**Sights:** Adjustable  
**Weight:** 6 lb. 8 oz.  
**Caliber:** .223 Rem./5.56 NATO  
**Magazine:** Detachable box, 30 rounds  
**Features:** The milled gas block is located at a carbine length (M4) position; multiple attachment points include a QD socket and bayonet lug; front sight post is elevation adjustable, and a front sight tool is included; A-2 Style F-Height allows co-witness with many optics; Ruger Rapid Deploy folding rear sight provides windage adjustability; six-position telescoping M4-style buttstock and Mil-Spec buffer tube; barrel is cold hammer-forged; Ruger flash suppressor; matte black oxide finish on the exterior of the bolt carrier

**Standard** ..... \$989.00  
**Magpul MOE furniture** . . . \$1039.00

## AR-556 MPR

**Action:** Semiautomatic  
**Stock:** Synthetic  
**Barrel:** 18 in.  
**Sights:** Adjustable post front, adjustable Ruger rapid deploy rear  
**Weight:** 6 lb. 8 oz.  
**Caliber:** 5.56 NATO, .450 Bushmaster, .350 Legend  
**Magazine:** 5, 10, 30 rounds  
**Features:** M-LOK accessory-compatible 15-in. free-floating handguard; Ruger's Elite 452 AR trigger; rifle-length gas system; contoured barrel that reduces overall weight; low-profile gas block; stock is adjustable; long topside Picatinny rail; variants include a model with Magpul furniture, and state-compliant models that have either a non-threaded barrel or a fixed magazine  
**MSRP** ..... \$1089.00–\$1269.00

## AR-556 MPR FLAG SERIES

**Action:** Semiautomatic  
**Stock:** Synthetic  
**Barrel:** 18 in.  
**Sights:** None  
**Weight:** 6 lb. 13 oz.  
**Caliber:** 5.56 NATO  
**Magazine:** 30 rounds  
**Features:** A subtle if somewhat battle-worn American flag graphic is overlaid on the upper, lower, and handguard of this MSR; rifle-length gas system; Magpul MOE grip; Magpul MOE SL collapsible stock  
**MSRP** ..... \$1139.00

RIFLES



# Ruger (Sturm, Ruger & Co.)



**RUGER AMERICAN RIMFIRE TARGET**



**RUGER AMERICAN RIMFIRE TARGET STAINLESS**

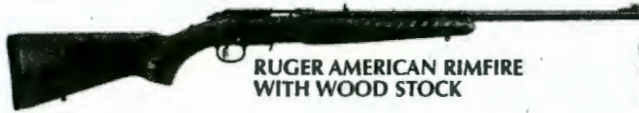

**RUGER AMERICAN RIMFIRE WITH WOOD STOCK**



**RUGER AR-556**



**RUGER AR-556 MPR**



**RUGER AR-556 MPR FLAG SERIES**

## AMERICAN RIMFIRE TARGET

**Action:** Bolt  
**Stock:** Laminate  
**Barrel:** 18 in.  
**Sights:** None  
**Weight:** 6 lb. 8 oz.-6 lb. 11 oz.  
**Caliber:** .17 HMR, .22 LR, .22 WMR  
**Magazine:** 9, 10 rounds  
**Features:** Ruger Marksman Adjustable trigger; aluminum Picatinny rail; cold hammer-forged threaded bull barrel; Power Bedding; flush-fit BX-1 magazines. Variants include GO Wild Camo I-M stocks with burnt bronze Cerakote or black synthetic stocks, some with adjustable stock modules, and blue or stainless metalwork  
**MSRP** ..... \$449.00-\$559.00

## AMERICAN RIMFIRE TARGET STAINLESS

**Action:** Bolt  
**Stock:** Laminate  
**Barrel:** 18 in.  
**Sights:** None  
**Weight:** 6 lb. 11 oz.  
**Caliber:** .22 LR, .22 WMR, .17 HMR  
**Magazine:** 9, 10 rounds  
**Features:** The durability and rust-resistance of a stainless receiver and barrel meet the Ruger American rimfire; flush-mount BX-1 magazine; Ruger Marksman Adjustable trigger; Power Bedding bedding block system  
**MSRP** ..... \$659.00-\$689.00

## AMERICAN RIMFIRE WOOD STOCK

**Action:** Bolt  
**Stock:** Wood  
**Barrel:** 22 in.

**Sights:** Fiber optic front, adjustable rear  
**Weight:** 6 lb. 2 oz.  
**Caliber:** .22 LR  
**Magazine:** 10 rounds  
**Features:** Extended magazine release; patent-pending Power Bedding integral bedding block system; Ruger Marksman Adjustable trigger offers a crisp release with a pull weight that is user adjustable between 3 and 5 lb.; wood stock with checkering on the grip and forend and a rubber butt pad for a comfortable length of pull; cold hammer-forged barrel  
**MSRP** ..... \$569.00

## AR-556

**Action:** Semiautomatic  
**Stock:** Synthetic  
**Barrel:** 16.1 in.  
**Sights:** Adjustable  
**Weight:** 6 lb. 8 oz.  
**Caliber:** .223 Rem./5.56 NATO  
**Magazine:** Detachable box, 30 rounds  
**Features:** The milled gas block is located at a carbine length (M4) position; multiple attachment points include a QD socket and bayonet lug; front sight post is elevation adjustable, and a front sight tool is included; A-2 Style F-Height allows co-witness with many optics; Ruger Rapid Deploy folding rear sight provides windage adjustability; six-position telescoping M4-style buttstock and Mil-Spec buffered; Ruger flash suppressor; matte black oxide finish on the exterior of the bolt carrier

**Standard** ..... \$989.00  
**Magpul MOE furniture** . . . \$1039.00

## AR-556 MPR

**Action:** Semiautomatic  
**Stock:** Synthetic  
**Barrel:** 18 in.  
**Sights:** Adjustable post front, adjustable Ruger rapid deploy rear  
**Weight:** 6 lb. 8 oz.  
**Caliber:** 5.56 NATO, .450 Bushmaster, .350 Legend  
**Magazine:** 5, 10, 30 rounds  
**Features:** M-LOK accessory-compatible 15-in. free-floating handguard; Ruger's Elite 452 AR trigger; rifle-length gas system; contoured barrel that reduces overall weight; low-profile gas block; stock is adjustable; long topside Picatinny rail; variants include a model with Magpul furniture, and state-compliant models that have either a non-threaded barrel or a fixed magazine  
**MSRP** ..... \$1089.00-\$1269.00

## AR-556 MPR FLAG SERIES

**Action:** Semiautomatic  
**Stock:** Synthetic  
**Barrel:** 18 in.  
**Sights:** None  
**Weight:** 6 lb. 13 oz.  
**Caliber:** 5.56 NATO  
**Magazine:** 30 rounds  
**Features:** A subtle if somewhat battle-worn American flag graphic is overlaid on the upper, lower, and handguard of this MSR; rifle-length gas system; Magpul MOE grip; Magpul MOE SL collapsible stock  
**MSRP** ..... \$1139.00

RIFLES



# Ruger (Sturm, Ruger & Co.)



RUGER CUSTOM SHOP 10/22 COMPETITION



RUGER CUSTOM SHOP 10/22 COMPETITION WITH SKELETONIZED GREEN MOUNTAIN STOCK



RUGER HAWKEYE ALASKAN



RUGER CUSTOM SHOP PRECISION RIFLE

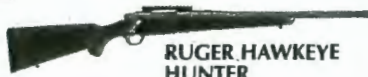

RUGER HAWKEYE HUNTER



RUGER HAWKEYE LONG-RANGE TARGET



RUGER HAWKEYE PREDATOR

## CUSTOM SHOP 10/22 COMPETITION

**Action:** Semiautomatic  
**Stock:** Laminate  
**Barrel:** 16.12 in.  
**Sights:** None  
**Weight:** 6 lb.  
**Caliber:** .22 LR  
**Magazine:** 10 rounds  
**Features:** A next-level .22 for the serious rimfire competitor with features that include: heat-treated and stress-relieved aluminum receiver; 30mm Picatinny rail for optics mounting; adjustable cheekpiece; free-floating barrel with rear cleaning port; extended ambidextrous magazine release; match-grade bolt release; BX Trigger; choice of traditional speckled black/gray laminate stock with satin black metalwork, natural brown laminate traditional stock with stainless steel hardware, or a Green Mountain skeletonized laminate thumbhole stock with angled forend, hard-coat anodized black receiver, and satin stainless barrel with black Cerakote accents  
**Speckled black/gray laminate stock** ..... \$899.00  
**Natural brown laminate stock** ..... \$1029.00

## CUSTOM SHOP 10/22 COMPETITION WITH SKELETONIZED GREEN MOUNTAIN STOCK

**Action:** Semiautomatic  
**Stock:** Laminate  
**Barrel:** 16.12 in.  
**Sights:** None  
**Weight:** 5 lb. 8 oz..  
**Caliber:** .22 LR  
**Magazine:** 10 rounds  
**Features:** Skeletonized laminate stock from Green Mountain; free-floating stainless steel barrel with black Cerakote highlights; 30 MOA topside

Picatinny rail; black hard-coat anodized receiver with rear cleaning port; dual bedding system; BX-Trigger; match bolt release; includes Ruger hard case, Custom Shop letter of authenticity, and challenge coin  
**MSRP** ..... \$1019.00

## HAWKEYE ALASKAN

**Action:** Bolt  
**Stock:** Hogue synthetic  
**Barrel:** 20 in.  
**Sights:** Bead front, adjustable rear  
**Weight:** 8 lb. 2 oz.  
**Caliber:** .375 Ruger, .338 Win. Mag., .300 Win. Mag.  
**Magazine:** 3 rounds  
**Features:** Ruger brings back the Alaskan in three bear/moose/wolf-stopping cartridges and with enough weight to sop up some of the recoil; Hogue overmolded stock; Hawkeye Matte durable metal finish; non-rotating, Mauser-type controlled round feed extractor; LC6 trigger  
**MSRP** ..... \$1569.00

## CUSTOM SHOP PRECISION RIFLE

**Action:** Bolt  
**Stock:** Synthetic  
**Barrel:** 26 in.  
**Sights:** None  
**Weight:** 12 lb. 14 oz.  
**Caliber:** 6mm Creedmoor  
**Magazine:** 10 rounds  
**Features:** Custom heavy-contour barrel that's free-floating, cold hammer-forged, and has R5 rifling; threaded muzzle with an APA muzzle brake; free-floating M-LOK handguard with slots on four sides and is flat-bottomed and compatible with RRS S.O.A.R. and other quick-detach systems; Magpul MOE K2 grip; Sorbothane cheek pad; Trigger Tech trigger; folding stock adjustable at cheekpiece and for length of pull; gray Cerakote finish  
**MSRP** ..... \$2419.00

## HAWKEYE HUNTER

**Action:** Bolt  
**Stock:** American walnut  
**Barrel:** 20 in., 22 in., 24 in.  
**Sights:** None  
**Weight:** 7 lb.-8 lb. 2 oz.  
**Caliber:** 6.5 Creedmoor, 6.5 PRC, .308 Win., .30-06 Spfd., .300 Win. Mag., 7mm Rem. Mag., .204 Ruger  
**Magazine:** 3, 4 rounds  
**Features:** American walnut stock; satin stainless hardware; non-rotating, Mauser-type controlled round feed extractor; 20 MOA topside Picatinny rail; free-floating cold hammer-forged barrel with 5R rifling  
**MSRP** ..... \$1359.00

## HAWKEYE LONG-RANGE TARGET

**Action:** Bolt  
**Stock:** Laminate  
**Barrel:** 24 in.  
**Sights:** None  
**Weight:** 10 lb. 11 oz.  
**Caliber:** .300 Win. Mag., 6.5 Creedmoor, 6.5 PRC, .204 Ruger, .308 Win.  
**Magazine:** 5 rounds  
**Features:** Heavy contour barrel; Ruger's Precision Rifle Muzzle Brake; two-stage target trigger; controlled round feed; fixed-blade ejector; a 20 MOA rail that screws down on top of Ruger's own integral mounts; adjustable laminate stock  
**MSRP** ..... \$1569.00

## HAWKEYE PREDATOR

**Action:** Bolt  
**Stock:** Laminate  
**Barrel:** 22 in., 24 in.  
**Sights:** None  
**Weight:** 7 lb. 11 oz.-8 lb. 2 oz.  
**Caliber:** .22-250 Rem., .223 Rem., .204 Ruger, .6.5 Creedmoor  
**Magazine:** 4 rounds  
**Features:** Non-rotating, Mauser-type controlled round feed extractor; hinged solid-steel floorplate; cold hammer-forged barrel; patented integral scope mounts  
**MSRP** ..... \$1399.00-\$1429.00



# Ruger (Sturm, Ruger & Co.)



RUGER MINI-14 RANCH RIFLE



RUGER MINI-14 TACTICAL

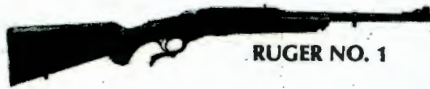

RUGER NO. 1



RUGER PC CARBINE



RUGER MINI-14 TACTICAL WOOD STOCK



RUGER PC CARBINE CHASSIS



RUGER PC CARBINE FLAG SERIES

## MINI-14 RANCH

**Action:** Semiautomatic  
**Stock:** Hardwood, synthetic  
**Barrel:** 18.5 in.  
**Sights:** Blade front sight, adjustable rear  
**Weight:** 6 lb. 12 oz.-7 lb.  
**Caliber:** 5.56 NATO, .223 Rem.  
**Magazine:** 5 rounds, or detachable box, 20 rounds  
**Features:** Stock comes in hardwood or black synthetic; Garand style action; hammer-forged barrel; sighting system; integral scope mounts; flat buttpad; integral sling swivels on hardwood or black synthetic stocks  
**MSRP** ..... \$1229.00-\$1409.00

## MINI-14 TACTICAL

**Action:** Semiautomatic  
**Stock:** Synthetic  
**Barrel:** 16.1 in.  
**Sights:** Adjustable  
**Weight:** 6 lb. 12 oz.-7 lb. 4 oz.  
**Caliber:** 5.56 NATO, .223 Rem., .300 BLK  
**Magazine:** Detachable box, 5, 20 rounds  
**Features:** Standard features include Garand-style action; flash suppressor; adjustable ghost ring rear sight, non-glare protected-post front sight; drilled and tapped receiver; Picatinny rail; scope rings; two magazines. Variants include black synthetic stock with stainless or blued hardware; ATI six-position collapsible/folding stock with blued hardware; speckled black/brown hardwood stock with blued hardware  
**MSRP** ..... \$1339.00-\$1439.00

## MINI-14 TACTICAL WOOD STOCK

**Action:** Semiautomatic  
**Stock:** Hardwood

**Barrel:** 16.12 in.  
**Sights:** Blade front, adjustable rear  
**Weight:** 7 lb. 3 oz.  
**Caliber:** 5.56 NATO  
**Magazine:** 20 rounds  
**Features:** The Mini-14 gets a new look and improved gripping surface with a speckled black-and-brown hardwood stock while retaining standard features such as its Garand-style, breech-bolt locking action  
**MSRP** ..... \$1299.00

## NO. 1

**Action:** Single-shot  
**Stock:** American walnut  
**Barrel:** 20 in.  
**Sights:** Blade front and rear  
**Weight:** 7 lb. 1 oz.  
**Caliber:** .450 Marlin, .308 Win., .450 Bushmaster  
**Magazine:** 1 round  
**Features:** Falling-block breech mechanism rifle includes a sliding tang safety; Ruger's patented scope mounting system; ejector that can be adjusted to perform as an extractor only; caliber changes from year to year and rifle is available in limited quantities; for 2022, this model is available through Lipsey's Distributors in: American walnut/satin blue in .257 Wby., .275 Rigby, and 6.5 Creedmoor  
**MSRP** ..... N/A

## PC CARBINE

**Action:** Semiautomatic  
**Stock:** Synthetic  
**Barrel:** 16.12 in.  
**Sights:** Protected blade front, adjustable ghost ring rear  
**Weight:** 6 lb. 12 oz.  
**Caliber:** 9mm  
**Magazine:** 10, 17 rounds  
**Features:** Interchangeable magwell that lets the operator use a variety of

Ruger or Glock magazines; buttstock is adjustable for length of pull via included spacers; magazine release and charging handle are both reversible; dead blow action with a tungsten weight both shortens the overall bolt travel, reduces felt recoil and muzzle rise  
**MSRP** ..... \$759.00

## PC CARBINE CHASSIS

**Action:** Semiautomatic  
**Stock:** Glass-filled polymer  
**Barrel:** 16.12 in.  
**Sights:** None  
**Weight:** 7 lb. 5 oz.  
**Caliber:** 9mm  
**Magazine:** 10, 17 rounds  
**Features:** A favorite carbine gets a technology upgrade; glass-filled polymer chassis foundation; aluminum free-floating handguard; threaded and fluted heavy-contour barrel; telescopic, six-position Magpul MOE buttstock; SR series magazine  
**MSRP** ..... \$979.00

## PC CARBINE FLAG SERIES

**Action:** Semiautomatic  
**Stock:** Glass-filled nylon  
**Barrel:** 16.12 in.  
**Sights:** Blade front, adjustable ghost ring rear  
**Weight:** 7 lb.  
**Caliber:** 9mm  
**Magazine:** 17 rounds  
**Features:** Quick-handling and visibly startling, you'll have loads of fun in PCC competitions thanks to the rifle's free-floating aluminum handguard; reversible magazine release and charging handle; heavy contour barrel; Type III hard coat anodizing  
**MSRP** ..... \$899.00

RIFLES



# Ruger (Sturm, Ruger & Co.)



RUGER PRECISION RIFLE



RUGER PRECISION RIMFIRE



RUGER PRECISION RIMFIRE FLAG SERIES



RUGER SCOUT RIFLE

RIFLES

## PRECISION RIFLE

**Action:** Bolt  
**Stock:** Synthetic  
**Barrel:** 20 in., 24 in.  
**Sights:** None  
**Weight:** 9 lb. 12 oz.-10 lb. 12 oz.  
**Caliber:** .308 Win., 6.5 Creedmoor, 6mm Creedmoor, .338 Lapua, .300 Win. Mag., 6.5 PRC, .300 PRC, 6mm Creedmoor  
**Magazine:** 10 rounds  
**Features:** Cold hammer-forged chrome-moly steel barrel with 5R rifling at minimum bore and groove dimensions, minimum, headspace and centralized chamber; Samson Evolution KeyMod handguard; 20 MOA Picatinny rail; in-line recoil path manages recoil directly from the rear of the receiver to the buttstock; patent-pending multi-magazine interface functions interchangeably with M110, SR25, DPMS, and Magpul-style magazines and AICS magazines (works with some M14 magazines); Ruger Marksman Adjustable trigger  
**MSRP** ..... \$1879.00-\$2459.00

## PRECISION RIMFIRE

**Action:** Bolt  
**Stock:** Synthetic  
**Barrel:** 18 in.  
**Sights:** None  
**Weight:** 6 lb. 12 oz.  
**Caliber:** .22 LR, .22 WMR, .17HMR  
**Magazine:** 10, 15 rounds  
**Features:** One-piece molded chassis is mated with an oversized bolt; adjustable bolt throw to prevent short stroking; Ruger's Marksman Adjustable trigger; reversible safety; glass-filled nylon buttstock is fully adjustable; Picatinny rail bag rider for monopod use; a molded in window allows squeeze bag attachment  
**MSRP** ..... \$599.00

## PRECISION RIMFIRE FLAG SERIES

**Action:** Bolt  
**Stock:** Glass-filled nylon chassis  
**Barrel:** 18 in.  
**Sights:** None  
**Weight:** 6 lb. 13 oz.  
**Caliber:** .22 LR  
**Magazine:** 15 rounds  
**Features:** Competition-ready rimfire features a one-piece chassis and

Quick-Fit adjustable buttstock, both of glass-filled nylon; Ruger Marksman Adjustable trigger  
**MSRP** ..... \$649.00

## SCOUT RIFLE

**Action:** Bolt  
**Stock:** Laminate; synthetic; wood  
**Barrel:** 16.50 in.  
**Sights:** Post front sight, adjustable rear  
**Weight:** 7 lb.  
**Caliber:** .308 Win., .350 Legend, .450 Bushmaster  
**Magazine:** Detachable box, 10 rounds  
**Features:** Flash suppressor, Picatinny rail; recoil pad; integral scope mounts; Mauser-type extractor; detachable magazine; stainless finish bolt. Variants include black laminate stock with matte blue barrel/receiver and 10-round magazine; black laminate stock with stainless barrel/receiver and 10-round magazine; black synthetic stock with matte black barrel/receiver and five-round magazine; black synthetic stock with stainless barrel/receiver and 10-round magazine; wood stock in .450 Bushmaster only with Ruger Precision Rifle Hybrid Muzzle Brake, blued barrel/receiver, four-round magazine  
**MSRP** ..... \$1409.00-\$1479.00

# Sako



SAKO 85 BAVARIAN CARBINE

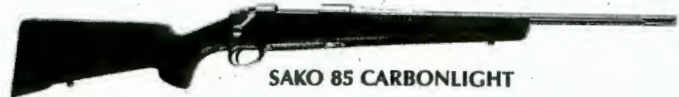

SAKO 85 CARBONLIGHT

## 85 BAVARIAN CARBINE

**Action:** Bolt  
**Stock:** Walnut  
**Barrel:** 22.5, 24.3 in.  
**Sights:** Rifled sights  
**Weight:** N/A  
**Caliber:** .308 Win., .270 Win., .30-06 Spfd., .300 Win. Mag., 6.5 Creedmoor  
**Features:** Featuring a full Mannlicher

stock with Schnabel fore-tip and Bavarian cheekpiece/comb; iron sights; sling swivel studs; single set trigger  
**MSRP** ..... \$2225.00

## 85 CARBONLIGHT

**Action:** Bolt  
**Stock:** Carbon fiber  
**Barrel:** 20 in.

**Sights:** None  
**Weight:** 5 lb. 5 oz.  
**Caliber:** .308 Win., .260 Rem., 7mm-08 Rem.  
**Magazine:** Detachable box, 5 rounds  
**Features:** Fluted barrel; stainless steel action; stainless steel barrel; single stage trigger; single set trigger available  
**MSRP** ..... \$3175.00



# Glock

HANDGUNS



GLOCK G33  
GEN4

### G39 GEN4

**Action:** Semiautomatic  
**Grips:** Polymer  
**Barrel:** 3.42 in.  
**Sights:** Fixed  
**Weight:** 24.18 oz.  
**Caliber:** .45 G.A.P.  
**Capacity:** 6, 8, 10 rounds  
**Features:** Striker-fired, polymer framed pistol with safe action system, trigger safety, hexagonal barrel, DAO action  
**MSRP**.....\$614.00



GLOCK G36

### Subcompact Slimline

#### G36

**Action:** Semiautomatic  
**Grips:** Polymer  
**Barrel:** 3.77 in.  
**Sights:** Fixed  
**Weight:** 22.42 oz.  
**Caliber:** .45 ACP  
**Capacity:** 6 rounds  
**Features:** Striker-fired, polymer framed pistol with safe action system, trigger safety, hexagonal barrel, DAO action, single-stack magazine  
**MSRP**.....\$637.00



GLOCK G42

#### G42

**Action:** Semiautomatic  
**Grips:** Polymer  
**Barrel:** 3.25 in.  
**Sights:** Fixed  
**Weight:** 13.76 oz.  
**Caliber:** .380 ACP  
**Capacity:** 6 rounds  
**Features:** Striker-fired, polymer framed pistol with safe action system, trigger safety, hexagonal barrel, DAO action, single-stack magazine  
**MSRP**.....\$480.00



HÄMMERLI MODEL  
X-ESSE LONG

### MODEL X-ESSE

**Action:** Semiautomatic  
**Grips:** Composite  
**Barrel:** 4.5 in., 5.9 in.  
**Sights:** Adjustable

**Weight:** 27.9–31 oz.  
**Caliber:** .22 LR  
**Capacity:** 10 rounds  
**Features:** Single-action, two-stage trigger; universal hi-grip  
**MSRP**.....\$1239.00

# Hämmerli



HECKLER & KOCH  
HK45

### HK45

**Action:** Semiautomatic  
**Grips:** Polymer  
**Barrel:** 4.53 in.  
**Sights:** Fixed  
**Weight:** 31 oz.  
**Caliber:** .45 ACP  
**Capacity:** 10 rounds  
**Features:** DA/SA with control lever; integral Picatinny rail; ambidextrous controls with dual slide releases; modified Browning linkless recoil operating system; polygonal rifling; open square notch rear sight with contrast points; low profile drift adjustable three-dot sights; available in black, RAL8000 green brown, and olive finishes

**MSRP**..... \$849.00–\$949.00

# Heckler & Koch

### HK45 COMPACT

**Action:** Semiautomatic  
**Grips:** Synthetic  
**Barrel:** 3.94 in.  
**Sights:** Adjustable 3-dot  
**Weight:** 28.48 oz.  
**Caliber:** .45 ACP  
**Capacity:** 8 or 10 rounds  
**Features:** Picatinny rail molded into the polymer frame dust cover; slim-line grip profiles with user replaceable grip panels; ambidextrous controls with dual slide releases and enlarged magazine release; uses the proven modified Browning linkless recoil operating system; O-ring barrel; contoured and radiused slide with forward slide (grasping) grooves and anti-glare longitudinal ribs; polymer frame; available in black, RAL8000 green brown, and olive finishes

**MSRP**..... \$849.00–\$949.00



HECKLER & KOCH  
HK45 COMPACT



# Heckler & Koch

HANDGUNS



## HK45 COMPACT TACTICAL

**Action:** Semiautomatic  
**Grips:** Textured polymer  
**Barrel:** 4.57 in.  
**Sights:** 3-dot  
**Weight:** 29.12 oz.  
**Caliber:** .45 ACP  
**Capacity:** 10 rounds  
**Features:** Proprietary internal mechanical recoil reduction system; O-ring barrel; cold-hammer-forged barrel; available in black, RAL8000 green brown, and olive finishes; supplied with one additional backstrap; night sights optional  
**MSRP** .....\$1029.00

## HK45 TACTICAL

**Action:** Semiautomatic  
**Grips:** Polymer with finger grooves  
**Barrel:** 5.16 in.  
**Sights:** 3-dot tritium night sights  
**Weight:** 31.7 oz.  
**Caliber:** .45 ACP  
**Capacity:** 10 rounds  
**Features:** Polymer frame; recoil-operated with modified Browning locking system; threaded barrel; Picatinny rail; key-based HK Lock-Out system; nine different trigger firing modes; available in black, RAL8000 green brown, and olive finishes; supplied with one additional backstrap; night sights optional  
**MSRP** .....\$1029.00

## HK416 .22LR

**Action:** Semiautomatic  
**Grips:** Synthetic  
**Barrel:** 8.5 in.  
**Sights:** Flip-up front, rear  
**Weight:** 72 oz.  
**Caliber:** .22 LR  
**Capacity:** 10, 20, 30 rounds  
**Features:** The looks of the real-deal

HK416 but in a semiauto rimfire; last-round bolt hold-open; pistol grip with storage compartment; RIS rail interface with M-LOK; functional dust cover; aluminum receiver  
**MSRP** .....\$529.00

## MARK 23

**Action:** Semiautomatic  
**Grips:** Polymer  
**Barrel:** 5.9 in.  
**Sights:** 3-Dot  
**Weight:** 39.4 oz.  
**Caliber:** .45 ACP  
**Capacity:** 12+1 rounds  
**Features:** Threaded O-ring barrel with polygonal bore profile; match grade trigger; one piece machined steel slide; frame mounted decocking lever and separate ambidextrous safety lever; HK recoil reduction system; ambidextrous magazine release lever  
**MSRP** .....\$2639.00

## P30

**Action:** Semiautomatic  
**Grips:** Polymer  
**Barrel:** 3.86 in.  
**Sights:** Fixed  
**Weight:** 26.08 oz.  
**Caliber:** 9mm, .40 S&W  
**Capacity:** 10, 15 rounds  
**Features:** Corrosion proof fiber-reinforced polymer frame; multiple trigger firing modes; HK recoil reduction system; blued finish; Picatinny rail; ambidextrous magazine release levers and side release  
**MSRP** .....\$839.00-\$949.00

## P30 L

**Action:** Semiautomatic  
**Grips:** Polymer  
**Barrel:** 4.4 in.  
**Sights:** Fixed

**Weight:** 27.5 oz.  
**Caliber:** 9mm, .40 S&W  
**Capacity:** 10, 13, or 15 rounds  
**Features:** Interchangeable backstraps and side panel grips in small, medium, and large sizes; ambidextrous slide and magazine releases levers; integral Picatinny rail; modular design allows DA trigger or DA/SA system, with a decocking button  
**MSRP** .....\$839.00-\$949.00

## P30SK

**Action:** Semiautomatic  
**Grips:** Rubber  
**Barrel:** 3.27 in.  
**Sights:** Fixed  
**Weight:** 23.99 oz.  
**Caliber:** 9mm  
**Capacity:** 10 rounds  
**Features:** Picatinny rail; interchangeable backstraps and lateral grip panels; available in multiple trigger firing modes including HK's enhanced double action only Law Enforcement Modification (LEM); trigger modes include conventional double action/single action (DA/SA)  
**MSRP** .....\$839.00-\$949.00

## P2000, P2000 SK

**Action:** Semiautomatic  
**Grips:** Polymer  
**Barrel:** 3.26-3.66 in.  
**Sights:** 3-Dot  
**Weight:** 23.8-25.9 oz.  
**Caliber:** 9mm, .40 S&W  
**Capacity:** 9-13 rounds  
**Features:** LEM trigger system; double-action; pre-cock hammer; ambidextrous magazine release and interchangeable grip straps; mounting rail  
**MSRP** .....\$929.00-\$1039.00



# Heckler & Koch

HANDGUNS

## SP5

**Action:** Semiautomatic  
**Grips:** Synthetic  
**Barrel:** 8.86 in.  
**Sights:** Post front, adjustable rear  
**Weight:** 82 oz.  
**Caliber:** 9mm  
**Capacity:** 10, 15, 30 rounds  
**Features:** If you've always yearned for an MP5, this is the next best thing in a super-compact 9mm that has a delayed blowback system; equipped with "bungee" sling  
**MSRP** ..... \$3279.00



HECKLER & KOCH SP5



HECKLER & KOCH SP5K PDW

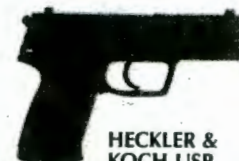

HECKLER & KOCH USP



HECKLER & KOCH USP COMPACT



HECKLER & KOCH USP TACTICAL



HECKLER & KOCH VP40

## SP5K PDW

**Action:** Semiautomatic  
**Grips:** Synthetic  
**Barrel:** 5.83 in.  
**Sights:** Ghost ring front, adjustable rear  
**Weight:** 67.2 oz.  
**Caliber:** 9mm  
**Capacity:** 10, 15, 30 rounds  
**Features:** A semiauto version of the famed MP5K with many of the same features, including a Navy-style threaded tri-lug adaptor; paddle magazine release; fluted chamber; "K" designation indicates shorter barrel and receiver  
**MSRP** ..... \$3279.00



HECKLER & KOCH VP9SK



HECKLER & KOCH VP9 TACTICAL OR

firing modes  
**MSRP** ..... \$1149.00-\$1379.00

## USP TACTICAL

**Action:** Semiautomatic  
**Grips:** Synthetic  
**Barrel:** 4.86 in.  
**Sights:** Adjustable  
**Weight:** 28.16 oz.  
**Caliber:** 9mm, .45 ACP  
**Capacity:** 10 or 15 rounds  
**Features:** High profile target sights; target sights with micrometer adjustment for windage and elevation; one piece machined, nitro-carburized steel slide; nine trigger firing modes; HK recoil reduction system; corrosion resistant "Hostile Environment" blued finish; corrosion proof fiber-reinforced polymer frame; oversized trigger guard for use with gloves; choice of flat and extended floorplate magazines; ambidextrous magazine release lever; extended slide release; extractor doubles as a loaded chamber indicator; patented Lock-Out Safety device  
**MSRP** ..... \$1559.00-\$1669.00

## VP9, VP40

**Action:** Semiautomatic  
**Grips:** Rubber  
**Barrel:** 4.09 in.  
**Sights:** Fixed  
**Weight:** 26.56 oz.  
**Caliber:** .40 S&W, 9mm  
**Capacity:** 10, 13, 15 rounds  
**Features:** Ergonomic handgun grip design that includes three changeable

backstraps and six grip side panels; ambidextrous controls; extended Picatinny rail molded into the polymer frame; captive flat recoil spring; supplied with two additional backstraps and two sets of lateral grip plates; night sights optional; specialty versions available with gray, OD Green, or Flat Dark Earth frames; tactical versions add threaded barrels and night sights; now available optics ready  
**MSRP** ..... \$839.00-\$999.00

## VP9SK

**Action:** Semiautomatic  
**Grips:** Polymer  
**Barrel:** 3.39 in.  
**Sights:** Drift-adjustable front, rear  
**Weight:** 23.07 oz.  
**Caliber:** 9mm  
**Capacity:** 10, 13, 15 rounds  
**Features:** A light subcompact striker-fire with an adjustable grip; slide and magazine release are ambidextrous; grip is finger-grooved and textured; slide has serrations front and rear; accessory rail; magazines are available flush or with a finger rest extension; available in black, Flat Dark Earth, Gray, or OD Green frames  
**MSRP** ..... \$839.00-\$999.00

## VP9 TACTICAL OR

**Action:** Semiautomatic  
**Grips:** Polymer  
**Barrel:** 4.7 in.  
**Sights:** Night sights front, rear  
**Weight:** 26.8 oz.  
**Caliber:** 9mm  
**Capacity:** 10, 17 rounds  
**Features:** Suppressor- and optics-ready; threaded barrel; suppressor-height night sights; optics slide cut with five mounting plates; supplied with three 10- or three 17-round magazines  
**MSRP** ..... \$1059.00

## USP

**Action:** Semiautomatic  
**Grips:** Polymer  
**Barrel:** 4.25-4.41 in.  
**Sights:** 3-Dot  
**Weight:** 27.2-31.36 oz.  
**Caliber:** 9mm, .40 S&W, .45 ACP  
**Capacity:** 12, 13, 15 rounds  
**Features:** Browning-type action with a patented recoil reduction system; double and single action modes; available in nine trigger/firing mode configurations; fiber-reinforced polymer frame; blued finish; ambidextrous magazine release trigger  
**MSRP** ..... \$1119.00-\$1379.00

## USP COMPACT

**Action:** Semiautomatic  
**Grips:** Polymer  
**Barrel:** 3.58-3.80 in.  
**Sights:** Fixed  
**Weight:** 25.6-28.2 oz.  
**Caliber:** 9mm, .40 S&W, .45 ACP  
**Capacity:** 8, 12, 13 rounds  
**Features:** Corrosion proof fiber-reinforced polymer frame; ambidextrous magazine release lever; grooved target triggers; nine trigger



# Walther Arms

HANDGUNS



## CCP (CONCEALED CARRY PISTOL)

**Action:** Semiautomatic  
**Grips:** Synthetic  
**Barrel:** 3.54 in.  
**Sights:** Adjustable  
**Weight:** 22.33 oz.  
**Caliber:** 9mm  
**Capacity:** 8+1 rounds  
**Features:** Available in black or stainless steel; interchangeable front sight with white dot; adjustable rear sight; reversible magazine release  
**MSRP . . . . . starting at \$419.00**

## CCP M2 .380

**Action:** Semiautomatic  
**Grips:** Polymer  
**Barrel:** 3.54 in.  
**Sights:** White three-dot  
**Weight:** 19.4 oz.  
**Caliber:** .380 ACP  
**Capacity:** 8 rounds  
**Features:** External safety; slide serrations front and rear; aggressive grip texture; reversible mag release; in a stainless slide, black slide, or a black slide with a built-in Viridian laser  
**MSRP . . . . . \$499.99**

## CREED

**Action:** Semiautomatic  
**Grips:** None  
**Barrel:** 4 in.  
**Sights:** Three-dot, low profile  
**Weight:** 26.6 oz.  
**Caliber:** 9mm  
**Capacity:** 16, 10 rounds  
**Features:** Economically priced, polymer frame; DAO pre-set trigger pistol; firing pin and drop safeties; ambidextrous magazine release button; 1913 Picatinny rail  
**MSRP . . . . . \$429.99**

## P22

**Action:** DA/SA semiautomatic  
**Grips:** Polymer  
**Barrel:** 3.42 in., 5 in.  
**Sights:** 3-dot adjustable low-profile  
**Weight:** 17 oz., 22 oz.  
**Caliber:** .22 LR  
**Capacity:** 10 rounds  
**Features:** Threaded barrel, interchangeable with target barrel; loaded chamber indicator; external slide stop; 3 safeties; two magazine styles; available with integrated laser-set; available in black, nickel, and military finish; now available with laser, Target models with 5-in. barrels available in black, Flat Dark Earth, or nickel  
**MSRP . . . . . \$309.00-\$449.00**

## P99AS

**Action:** DA semiautomatic  
**Grips:** Black polymer frame and grips  
**Barrel:** 4 in. stainless steel with Tenifer finish  
**Sights:** Front and rear tritium night  
**Weight:** 24 oz.-25.6 oz.  
**Caliber:** 9mm, .40 S&W  
**Capacity:** 15 (9mm) or 12 (.40 S&W) rounds  
**Features:** The first pistol with a firing pin block combines advantages of a traditional DA pull with SA trigger and a decocking button safety integrated into slide, allowing users the ability to decock the striker, preventing inadvertent firing in both DA and SA  
**MSRP . . . . . \$505.00-\$699.00**

## P99AS COMPACT

**Action:** Striker-fired semiautomatic  
**Grips:** Polymer  
**Barrel:** 3.5 in.  
**Sights:** 3-dot adjustable low-profile  
**Weight:** 20.8 oz.-22.4 oz.  
**Caliber:** 9mm, .40 S&W  
**Capacity:** 10 (9mm) or 8 (.40 S&W) rounds

**Features:** Flat-bottom magazine buttplate, finger rest magazine buttplate; molded with a Weaver-style rail; interchangeable backstraps; hammerless striker system and integral safety devices come standard  
**MSRP . . . . . \$469.00-\$545.00**

## PPK AND PPK/S

**Action:** DA/SA semiautomatic  
**Grips:** Polymer  
**Barrel:** 3.3 in.  
**Sights:** Fixed, open  
**Weight:** 22.4 oz. (PPK), 24 oz. (PPK/S)  
**Caliber:** .380 ACP  
**Capacity:** 6 (PPK) or 7 (PPK/S) rounds  
**Features:** Firing pin safety; manual safety with decocking function; double- and single-action trigger; extended beaver tail; nickel plated or blued finish  
**MSRP . . . . . \$849.00**

## PPK/S .22

**Action:** DA/SA semiautomatic  
**Grips:** Polymer  
**Barrel:** 3.3 in.  
**Sights:** Fixed, open  
**Weight:** 24 oz.  
**Caliber:** .22 LR  
**Capacity:** 10 rounds  
**Features:** Manual safety; top strap waved to reduce glare; internal slide stop; iconic PPK/S frame; beaver tail extension; nickel plated or black finish  
**MSRP . . . . . \$421.99**

## PPQ M2 .45 ACP

**Action:** Striker-fired semiautomatic  
**Grips:** Ergonomic polymer  
**Barrel:** 4.25 in.  
**Sights:** Three dot polymer  
**Weight:** 28 oz.  
**Caliber:** .45 ACP  
**Capacity:** 12 rounds  
**Features:** Custom Picatinny accessory rail; quick-defense trigger; ergonomic, non-slip, cross-directional grip surface; three safeties; Tenifer coating on slide and barrel; front and rear slide serrations; ambidextrous slide stop  
**MSRP . . . . . \$722.99**



# Walther Arms

HANDGUNS



WALTHER PPQ M2



WALTHER PPQ SC



WALTHER PPS M2

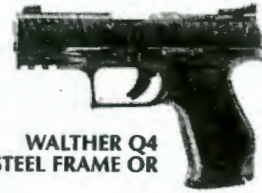

WALTHER Q4 STEEL FRAME OR



WALTHER Q4 TAC



WALTHER Q5 MATCH

## PPQ M2 9MM

**Action:** Striker-fired semiautomatic  
**Grips:** Polymer  
**Barrel:** 4 in., 4.1 in., 4.6 in., 5 in.  
**Sights:** 3-dot adjustable low-profile  
**Weight:** 24 oz. (9mm), 25.6 oz. (.40 S&W)  
**Caliber:** 9mm  
**Capacity:** 15 (9mm), 15/17 (9mm Navy SD) or 11 (.40 S&W) rounds  
**Features:** Quick defense trigger; three safeties; Tenifer coated slide and barrel with matte finish  
**MSRP..... \$549.99**

## PPQ SC

**Action:** Semiautomatic  
**Grips:** Synthetic  
**Barrel:** 3.5 in.  
**Sights:** Three-dot, windage-adjustable rear  
**Weight:** 21.2 oz.  
**Caliber:** 9mm  
**Capacity:** 10, 15 rounds  
**Features:** Sub-Compact is easy to conceal; unique grip texturing; wide trigger guard with serrations on the front for extra purchase; accessory rail; low-profile snag-resistant sights; interchangeable backstraps; ambidextrous slide release; slide has a Tenifer coating  
**MSRP.....\$435.00**

## PPS M2

**Action:** Striker-fired semiautomatic  
**Grips:** Ergonomic polymer  
**Barrel:** 3.18 in.  
**Sights:** Three dot metal  
**Weight:** 21.1 oz.  
**Caliber:** 9mm  
**Capacity:** 6, 7, 8 rounds  
**Features:** Front and rear slide serrations; smooth, light trigger; ergonomic, non-slip, cross-directional grip surface; cocking indicator; chamber viewport; slide stop; magazine release conveniently placed for thumb operation; three magazine options; LE (Law Enforcement) variation comes equipped with phosphoric sights and three magazines  
**MSRP..... \$429.99-\$599.99**

## Q4 STEEL FRAME

**Action:** Semiautomatic  
**Grips:** Polymer  
**Barrel:** 4 in.  
**Sights:** LPA with adjustable rear  
**Weight:** 39.7 oz.  
**Caliber:** 9mm  
**Capacity:** 15 rounds  
**Features:** Double-stack, steel-frame, striker-fire pistol that has an ergonomic wrap-around grip; extended beavertail; optics-ready slide; Picatinny accessory rail  
**MSRP.....\$1349.00**

## Q4 TAC

**Action:** Semiautomatic  
**Grips:** Synthetic  
**Barrel:** 4.6 in.  
**Sights:** Fiber optic front sight, adjustable target rear  
**Weight:** 26 oz.  
**Caliber:** 9mm  
**Capacity:** 15, 17 rounds  
**Features:** Ambidextrous slide stop and mag release; texturing on the grip; wide trigger guard with serrations for additional purchase; ergonomic and finger-grooved grip; magazine with finger rest; interchangeable backstraps for a custom fit; threaded barrel for suppressor add-ons; slide has been milled to be optics ready  
**MSRP.....\$749.00**

## Q5 MATCH

**Action:** Semiautomatic  
**Grips:** Synthetic  
**Barrel:** 5 in.  
**Sights:** Fiber optic front sight, adjustable target rear  
**Weight:** 27.9 oz.  
**Caliber:** 9mm  
**Capacity:** 15 rounds  
**Features:** Optics-ready slide; Picatinny rail; Walther ergonomic grip; ported slide; blue Quick Defense trigger; front and rear slide serrations; ambidextrous slide stop  
**MSRP.....\$979.99**

# Wilson Combat



WILSON COMBAT ACP, ACP COMMANDER, ACP COMPACT

## ACP, ACP COMMANDER, ACP COMPACT

**Action:** Semiautomatic  
**Grips:** G10  
**Barrel:** 4 in., 4.25 in., 5 in.  
**Sights:** Fiber optic front, battlesight rear  
**Weight:** 36.9 oz.-41.6 oz.  
**Caliber:** 9mm, .45 ACP  
**Capacity:** 8, 10 rounds

**Features:** With a full-size carbon steel frame, this pistol gets a Bullet Proof tactical thumb safety and high-grip beavertail safety; G10 Eagle Claw grip panels; carbon steel slide with Eagle Claw rear serrations  
**.45 ACP .....starting at \$2595.00**  
**9mm.....starting at \$2695.00**



# BALLISTICS

BALLISTICS



## 556 CENTERFIRE RIFLE BALLISTICS

556	.17 HORNET TO .222 REMINGTON	568	.280 REMINGTON TO 7MM REMINGTON MAGNUM	579	.300 WINCHESTER SHORT MAGNUM TO .300 WEATHERBY MAGNUM
557	.222 REMINGTON TO .223 REMINGTON	569	7MM REMINGTON MAGNUM TO 7MM WINCHESTER SHORT MAGNUM	580	.300 WEATHERBY MAGNUM TO .303 BRITISH
558	.223 REMINGTON TO 5.6x52 R	570	7MM WINCHESTER SHORT MAGNUM TO 7MM REMINGTON ULTRA MAGNUM	581	.303 BRITISH TO .338 FEDERAL
559	.22 PPC TO .220 SWIFT	571	7.21 (.284) FIREHAWK TO .30-30 WINCHESTER	582	.338 MARLIN EXPRESS TO .340 WEATHERBY MAGNUM
560	.220 SWIFT TO .243 WINCHESTER	572	.30-30 WINCHESTER TO .308 WINCHESTER	583	.340 WEATHERBY MAGNUM TO .35 REMINGTON
561	.243 WINCHESTER TO .25-06 REMINGTON	573	.308 WINCHESTER TO .308 WINCHESTER	584	.35 REMINGTON TO 9.3x74 R
562	.25-06 REMINGTON TO 6.5x55 SWEDISH	574	.308 WINCHESTER TO .30-06 SPRINGFIELD	585	9.3x74 R TO .375 WEATHERBY MAGNUM
563	6.5x55 SWEDISH TO 6.5 REMINGTON MAGNUM	575	.30-06 SPRINGFIELD TO .30-06 SPRINGFIELD	586	.375 JRS TO .416 REMINGTON MAGNUM
564	6.5 REMINGTON MAGNUM TO .270 WINCHESTER	576	.30-06 SPRINGFIELD TO .300 BLACKOUT	587	.416 RIGBY TO .45-70 GOVERNMENT
565	.270 WINCHESTER TO .270 WINCHESTER SHORT MAGNUM	577	.300 H&H MAGNUM TO .300 WINCHESTER MAGNUM	588	.45-70 GOVERNMENT TO .460 WEATHERBY MAGNUM
566	.270 WINCHESTER SHORT MAGNUM TO 7MM-08 REMINGTON	578	.300 WINCHESTER MAGNUM TO .300 REMINGTON SHORT ULTRA MAGNUM	589	.460 WEATHERBY MAGNUM TO .700 NITRO EXPRESS
567	7MM-08 REMINGTON TO .280 REMINGTON				

## 590 LONG RANGE RIFLE

590 6.6 CREEDMOOR TO .338 LAPUA

## 591 RIMFIRE BALLISTICS

591 .22 TO .17 HORNADY MAGNUM RIMFIRE

592 .17 HORNADY MAGNUM RIMFIRE TO .22 WINCHESTER RIMFIRE

## 593 CENTERFIRE HANDGUN BALLISTICS

593	.25 AUTO TO .32 S&W LONG	597	.38 SPECIAL TO .357 MAGNUM	600	.41 REMINGTON MAGNUM TO .45 AUTOMATIC (ACP)
594	.32 S&W LONG TO 9MM LUGER	598	.357 MAGNUM TO .40 S&W	601	.45 AUTOMATIC (ACP) TO .45 GAP
595	9MM LUGER TO .380 AUTO	599	.40 S&W TO .41 REMINGTON MAGNUM	602	.45 GAP TO .500 SMITH & WESSON
596	.380 AUTO TO .38 SPECIAL				

# Exhibit A-6



DEPOSITION  
EXHIBIT  
6

# Shooter's Bible<sup>®</sup> GUIDE TO AR-15s

2<sup>nd</sup> EDITION



- Photos, specifications, and prices
- Hundreds of models
- Sights, scopes, and accessories
- Details of the newest guns and options

**Doug Howlett  
and Robb Manning**  
Foreword by Tiger McKee



Copyright © 2016 by Doug Howlett and Robb Manning

Foreword copyright © 2016 by Tiger McKee

All rights reserved. No part of this book may be reproduced in any manner without the express written consent of the publisher, except in the case of brief excerpts in critical reviews or articles. All inquiries should be addressed to Skyhorse Publishing, 307 West 36th Street, 11th Floor, New York, NY 10018.

Skyhorse Publishing books may be purchased in bulk at special discounts for sales promotion, corporate gifts, fund-raising, or educational purposes. Special editions can also be created to specifications. For details, contact the Special Sales Department, Skyhorse Publishing, 307 West 36th Street, 11th Floor, New York, NY 10018 or [info@skyhorsepublishing.com](mailto:info@skyhorsepublishing.com).

Skyhorse® and Skyhorse Publishing® are registered trademarks of Skyhorse Publishing, Inc.®, a Delaware corporation.

Visit our website at [www.skyhorsepublishing.com](http://www.skyhorsepublishing.com).

10 9 8 7 6 5 4 3

Library of Congress Cataloging-in-Publication Data is available on file.

Cover design by Brian Peterson

Print ISBN: 978-1-5107-1-097-9

Ebook ISBN: 978-1-5107-1-098-6

Printed in China

# CONTENTS

FOREWORD	8
INTRODUCTION	9
<b>CHAPTER 1</b>	
HISTORY	14
<b>CHAPTER 2</b>	
BREAKING DOWN THE AR	20
<b>CHAPTER 3</b>	
NEW RIFLES	30
<b>CHAPTER 4</b>	
AR RIFLE MODELS	51
<b>CHAPTER 5</b>	
D-I-Y RIFLES	176
<b>CHAPTER 6</b>	
OUTFITTING YOUR RIG	185
<b>CHAPTER 7</b>	
THE SPORTING AR	203
<b>CHAPTER 8</b>	
AR RIFLES: ULTIMATE HOME DEFENSE	211
<b>CHAPTER 9</b>	
WHAT THE FUTURE HOLDS	219
<b>APPENDICES</b>	
<b>APPENDIX I</b>	
AR MANUFACTURERS	225
<b>APPENDIX II</b>	
AMMUNITION MANUFACTURERS	227
<b>APPENDIX III</b>	
OPTICS AND SIGHTS MANUFACTURERS	228
<b>APPENDIX IV</b>	
AR ACCESSORIES AND SUPPLIERS	229
<b>ACKNOWLEDGMENTS</b>	230



# 1. History of the AR

For all of its popularity among the military, law enforcement and civilian shooters today, the AR-15 almost never happened. Or at the very least, its development was almost grounded before it really got the chance to fly. Dissatisfied with the overall performance of the M14 rifle that was in service at the time, the Army in the 1950s sought the assistance of commercial gun manufacturers in developing a .22-caliber firearm capable of replacing it in combat.

As the military had crossed the bridge from a post-World War II era, the focus of many of the branches was on devising tactics, equipment and machinery capable of countering the nuclear capabilities of our new age Cold War enemies. Partially responsible for this task within the U.S. Army was the Operations Research Office, created after World War II. However, the ORO increasingly found itself attempting to solve non-nuclear related challenges prompted by our country's engagement in North Korea. One such concern, recounted in the late Edward C. Ezell's book, *The Great Rifle Controversy*, one of the most detailed and comprehensive examinations of military small arms development in the United States between the close of World War II and the early 1980s, was that "ORO investigators discovered that very little was known about the nature of inflicting wounds on the human body in combat."

As a result, the Infantry Division of ORO began to study the issue by analyzing more than 3 million casu-

alties from World Wars I and II, as well as those that had occurred in Korea up to that point. For the first time, an analysis suggested that more soldiers were killed by randomly dispersed fire than carefully aimed shots, suggesting that a light-recoiling rifle that could rapidly launch multiple projectiles in a controlled, yet simultaneously spread pattern, could ultimately be more effective on the battlefield.

Following several years of studying the idea, the Continental Army Command (CONARC) decided to seek the development of a 5.56mm rifle. They reached out to both Winchester, owned by Olin, which now only manufactures the ammunition under that brand, and the ArmaLite Division of Fairchild Engine & Airplane Corp., which today is simply known as ArmaLite Inc. (But ironically no longer owns the trademark for the actual AR-15 name. More on that in a moment.)

## ARMALITE'S NEW CONCEPT RIFLE

According to a history of ArmaLite, Inc., recognizing that there had been little done in the way of advancing fundamental small arms design and function in the past 50 years, Fairchild executives president Richard S. Boutelle, a gun enthusiast, and Paul S. Cleveland, corporate secretary, wanted to focus on developing fine sporting arms for the commercial market with the hope that their work would catch the eyes of military leaders and provoke some interest. However, shortly after establishing the ArmaLite Division, the company was

HISTORY OF THE AR



⌘ Today's M4, an AR variant, is the top choice among many of our nation's military. Photo Credit: DoD Photos



invited by the U.S. Air Force to submit a rifle design that would replace the branch's survival rifle. Within a matter of weeks, ArmaLite submitted a rifle dubbed the AR-5 to the Air Force for evaluation. The rifle was built around the .22 Hornet. The Air Force adopted the rifle, which was officially designated the MA-1 Survival Rifle. This success forced the company to rethink its original decision to pursue the commercial market and instead, they changed course and focused exclusively on developing arms for the military.

From there, three people involved with ArmaLite came together to alter the course of modern firearms as we know them. According to ArmaLite, it was the idea of George Sullivan, a chief patent counsel for Lockheed Aircraft Corporation, to use the "latest technical advances in plastics and alloys" to build firearms that were lighter and more functional than then-available models. In fact, Sullivan, a tinkerer himself, had begun work on some of his ideas in his garage following World War II. Charles Dorchester directed and coordinated all of ArmaLite Division's development programs and would later go on to run the entire company. But perhaps most recognizable of the three whom would go on to change history and the one historical scholars credit for the birth of the AR platform was Eugene Stoner. Stoner, who had served as a Marine during the war and was considered an ordnance expert, was made chief engineer of the ArmaLite Division in 1954. He had been working on developing small arms independently since the war as well. It is Stoner's patents that "form the basis of much of ArmaLite's work," according to the company's historical records.

In 1955, the Army was looking to update or replace the service rifle of the time, the M1 Garand, and were considering two versions: Springfield Armory's T-44, merely an updated version of the Garand, and



⌘ Eugene Stoner, creator of the AR design.

the T-48, a version of the 7.62x51mm FN FAL, which was developed and manufactured by Fabrique Nationale de Herstal, known today primarily as FN Herstal. The FAL would ultimately go on to be adopted by as the primary service rifle used by many NATO coun-

tries including Belgium, Great Britain, Canada and Australia.

To compete with these firearms, Stoner took a totally new approach in firearms design of the day and created the AR-10. The first version of the AR-10 was made with aircraft grade aluminum receivers, keeping the weight down considerably from what it looked like it might weigh. In fact, empty, the rifle weighed less than 7 pounds. The receivers could be made from such lightweight material because the bolt locked into a steel extension that attached to the barrel, not directly in the receiver itself. Stocks, pistol grips and fore-ends were all plastic compared to the wood-grain furniture more common to guns of the day. Unfortunately, despite capturing the attention of more than a few military leaders intrigued by the firearm's unique design, the ArmaLite Division had gotten involved too late to adequately compete. An article that first appeared in the May 1962 issue of *American Rifleman* magazine noted that the initial AR-10 had also fallen prey to flaws with its original composite steel-aluminum barrel and a complicated flash suppressor.

According to Ezell, however, of those leaders intrigued by the AR-10's design included CONARC's commander, Gen. Willard G. Wyman. In 1957, Wyman personally asked Stoner to design a 5.56mm rifle for the Army similar to the AR-10. That scaled-down rifle would go on to become the AR-15.

The first AR-15s had steel barrels and an Army-developed BAR-type flash suppressor. And while Stoner's design has been called genius by many, the real genius may have been found in the engineer's ability to borrow features from a number of popular and proven European gun designs and combine them

⌘ In the form of the M16, the AR made its way into the hands of our military by 1963. Photo Credit: DoD Photos





in a single platform. The now-ubiquitous hinge design of the AR, not unlike that of a break-open shotgun, was similar to a design used in the Czech ZH or ZB 29 rifle and adopted in the FN. The rear sight was built into the rear of the carrying handle like the British EM 2, the hinged cover on the ejection port resembled that of the German Sturmgewehr 44, the locking system was similar to the one used in the Johns Semiautomatic Rifle from the 1940s and the straight stock, designed to better accommodate recoil and manage multiple shots, was similar to a number of auto and semi-auto rifle designs getting some play at the time, including as Ezell pointed out, the Harvey T25.

Stoner's gas operating system, which employed, and still does on direct impingement ARs, a tube beneath the front sight and directed gas back to the bolt in order to cycle rounds during firing, had been used in the both Swedish M42 Ljungman and the French MAS 1949.

"Stoner's achievement in the AR-15 was the combination of all of these ideas into an attractive package," wrote Ezell. Of course, once designed, the rifle still had to win favor with the military, a battle that almost ended the AR-15's prominent role in history right there.

To begin, ArmaLite was so small, it didn't have a full research facility or the staff to completely develop a fully tested prototype. Instead, they had to rely on military testers, many whom had their own prejudices against this new weapon and did it few favors to discover if it could actually serve soldiers well. There were some key leaders in the Army who simply didn't like the fact that the new gun hadn't been developed within the branch's own usual channels. Others simply didn't like the new configuration of the gun, much as some traditional-minded hunters view the firearm even today. Rain tests conducted on a test sample of the rifles originally suggested that shooting the guns with water in the barrels could result in burst barrels—something that was believed at the time to be "characteristic of high-velocity rifles having a bore diameter of less than .25 caliber," according to Ezell. ArmaLite strengthened the barrels in response, but still concerns over the hazard persisted. Arctic tests conducted on the rifles to determine how they would perform in freezing weather also proved disappointing to testers, though the Winchester .224 rifle still being considered

at the time also failed in this respect. In the end, the test board reviewing the new rifles suggested that a ".223 (5.56mm) round was not a suitable replacement for the 7.62 NATO round" and that development of a heavier .258 caliber (6.35mm) cartridge be pursued (Ezell). In light of the recommendations, Army Chief of Staff Gen. Maxwell Taylor ruled the branch would continue procuring the heavier and already NATO approved 7.62 M14 rifles.

## SECOND CHANCE

After all of the expense in developing the AR-15, it was a tough financial blow to a small company like Fairchild, which, struggling to make ends meet, had actually already begun to search for a company to which to license the production of both the AR-15 and the AR-10. The company had invested in the AR-15 project alone \$1.45 million, an amount that by today's corporate standards would be fairly cheap but for any small company, then or now, could be a backbreaker. Fairchild decided to recoup some of the costs of the protracted project by selling the manufacturing and marketing rights to what was then called Colt's Patent Firearms Manufacturing Company, but is better known today simply as Colt's Manufacturing, LLC, or merely Colt. The company bought the rights to both firearms (a version of the AR-10 had already been sold to the Dutch and was being marketed in Southeast Asia where conflicts were erupting in what was then a little-known country called Vietnam) for \$75,000 cash payment and a guarantee of a 4 ½ percent royalty on all future sales.

In *The Black Rifle: M16 Retrospective* by R. Blake Stevens and Edward C. Ezell, the authors note that at the time, Colt was also suffering financially as a result of dried up military and civilian markets following WWII. The company also hadn't retooled its manufacturing facilities in nearly a century. The Maryland-based firm of Cooper-MacDonald, which through one of its principles, Robert W. "Bobby" MacDonald already promoted the Dutch AR in Southeast Asia, worked with both ArmaLite and Colt and had been the connection that brought the sale of the ARs together. Interestingly, Cooper-MacDonald made more off the sale of the guns to Colt than





⚡ The first true military version of the AR-15, the M16, got its first full trial during the Vietnam War. Photo Credit: DoD Photos

Fairchild, netting \$250,000 and a 1 percent royalty on all future guns sold.

MacDonald, who had extensive contacts in Southeast Asia and saw the AR-15 as an ideal gun for the “smaller statured” fighters of the region, immediately began marketing the gun in that part of the world and, under orders from Colt, to the U.S. military once again. They wanted to see the AR-15 given another chance.

Initially Army representatives refused. But Colt had better luck when they decided to bypass the branch and seek other military buyers. Ultimately, Air Force Vice Chief of Staff Gen. Curtis LeMay, who witnessed a demonstration of the guns, suggested that the Air Force test the AR-15 as a replacement for the M2 carbines used by its sentries. The tests proved positive and the Air Force placed an initial order for 8,500 rifles (Ezell). Sometimes it just takes that one lucky break to get the door to open wider than your foot and allow you to walk on through.

Studies by the Defense Department, who agreed to give the gun another look, also proved favorable, causing questions to be asked all the way up the chain of command as to why the disparity between the Army’s original findings and the reports coming out about the gun then. Indeed, both Secretary of Defense Robert McNamara and even then President John F. Kennedy had questions. Ultimately, the Army was forced to reevaluate the rifle the result being in 1963 that the

decision was made to end procurement of the M14. At the same time, McNamara ordered the purchase of 85,000 AR-15s for the Army and 19,000 for the Air Force, who was already using some of the guns, to begin the following year (Ezell).

The purchase was initially intended to be a one-time deal—enough to fill the gap until another weapons testing program was complete and a new firearm developed, but history proves that did not become the case. To meet demand for the growing conflict in Vietnam, the Army ordered more of the rifles and reclassified it as the M16.

## NOT DONE YET

Once the AR-15/M16 made its way to soldiers’ hands and was finally being tested on the battlefield, problems began to arise. While the overall opinion was that most soldiers liked the overall design and concept of the rifle, its immediate popularity was hindered by a few problems operators encountered in the field—mainly the gun malfunctioning during combat. Reviews revealed several causes for this including ammunition that didn’t function properly in the rifle because of its high-residue powder. The Army had insisted on a faster-burning ball-type powder for use in the field instead of the cleaner powder Stoner had used in developing the rifle because they wanted





⚡ While the design of the M16 was generally well received by Vietnam-era soldiers, the model was not without its problems, primarily malfunctions when dirty.

to generate higher muzzle velocities. The Army also failed to secure chrome-lined barrels and chambers in the rifles, which resisted heat and fouling better as well as corrosion and pitting. Perhaps most egregiously ignored was the lack of proper cleaning supplies and quite simply a failure to properly train troops with the new rifle and enforce its frequent cleaning.

In fact, according to former long-distance AR competition shooter John Murphy, who has shot ARs extensively and studied their history, the original M16 was originally billed as a gun that didn't require much care or cleaning.

"The chamber on the .223 was not chrome plated. It got so hot that cases were sticking and with all of the gunk and powder, the gun would jam up," says Murphy. "The gun was marketed as one that didn't need cleaning, which was bunk. You have to always clean a gun." The cleaning of magazines was also found to be crucial as they would fill with grime and quit feeding rounds into the chamber during firing. Indeed when asked about how often he cleaned his M4, the military's modern, shorter version of the original M16 design, one recently retired Navy SEAL who has seen action in both Afghanistan and Iraq, said simply "every chance you get. Your life depends on it."

As more troops began carrying the new rifle into Vietnam, training and cleaning procedures—for both the rifle and its magazine—improved and with it, fewer reports of malfunctioning guns. In fact, the lack of proper cleaning seemed to fix much of what the initial concerns about the M16 were. Improvements in the propellant used in the military-issued ammunition also reduced reports of problems with the guns.

Over the years, the gun design has undergone a number of improvements and variations as requested by various branches of the military—and even by some civilian engineers and shooters—including the addition of: a forward assist, to aid in locking the bolt forward in rare instances when it fails to do so; flat-top receivers; heavier barrels; adjustable windage rear sights; selector switch functions that reduced full-auto firing to the firing of three-round bursts; a gas piston operating system as an option to the direct impingement design; and other minor tweaks including adjustments in stock length, thickness of barrels and stock design and functionality. Where the military design has wandered, the civilian market has followed.

One of the most notable changes in the rifle over time occurred with its rifling. Original models often had a 1-in-14-inch (1:14) or 1-in-12-inch (1:12) twist for use with the lighter 55-grain bullets used for combat at the time. This worked great for shooting targets under 300 yards and indeed, most combat engagement occurred at 100 yards or less, most often due to terrain features and limitations more so than an inability of the shooter. However, for long range shooting—ranges of out to 600 yards as was required in high-power competition matches or sniping—the gun was inadequate.

## HISTORY OF THE AR



⚡ Today, popularity of the AR among hunters is one of the driving forces behind the platform's high sales numbers.



To improve the M16's early performance, rifling in the barrel was changed to a 1:7 twist in order to better accommodate 62-grain bullets. >>

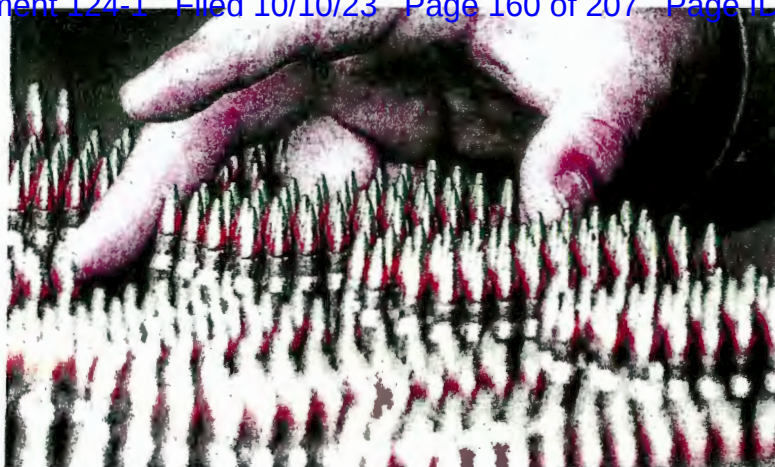

The 1:12 twist was unable to stabilize longer, heavier bullets needed for long distance shooting.

In "The Making of a Match Rifle," originally published in the July 1999 issue of *American Rifleman* by former Shooting Editor Glenn M. Gilbert, the author recounts how improvements in this area evolved following the adoption by NATO of a standard 5.56mm round loaded with a heavier 62-grain bullet, and which was fired from a barrel with a 1:9 twist. That bullet was designed by FN. In response, "the Army quickly developed a copy of the 62-grain FN bullet and standardized it as the M855 in 1981."

The rifling in the barrel of M16 was soon tightened to a 1:7 twist in order to accommodate the heavier bullet as well as tracers that were planned for the newly rifled firearms. Over time, the twist rate and development of longer bullets in the 77-grain and 80-grain arena solved the long range dilemma and produced a rifle that both military sharpshooters and civilian competitors could come to rely on. And indeed, once those problems were solved, the AR became a preferred gun of many competitors such as John Murphy.

"The Marines were the first ones to successfully carry the ARs to Camp Perry in 1994, and they cleaned everyone's clock with the new twist rates and the longer bullets," says Murphy.

Gilbert sums the AR's evolution up in his article by writing, "The AR-15 has come a long way. Long derided as a plastic toy, it is now the benchmark in accuracy among semi-auto rifles." It is this mix of both short-range application and long-range accuracy, combined with the multiple levels of personalization and functionality that have many experts predicting that the heyday of the AR is indeed here.

This sentiment, in fact, is continuing forward along dual paths. While there are a number of competing—and darn good—tactical rifle platforms available (the FN SCAR, HK416 and SIG 556xi are just a few that come immediately to mind), the U.S. Army, after a

multi-year effort to find a suitable replacement for the M4 recently decided to scrap the search and commit to converting the M4 to M4A1s. The M4, successor variant of the M16, with a shorter barrel, flat top, collapsible stock and less weight, has been in use since 1994. While it has received periodic upgrades over the years, the transition to the M4A1, with a heavier barrel, full-auto firing capability and ambidextrous controls, is underway and should be complete by 2020 according to reports by the *Army Times*. From a military perspective at least, this move cements the continuation of the AR's place as the weapon of choice for many of our nation's servicemen and women on the battlefield.

Despite criticisms of the platform's ability to perform without malfunctioning in sandy or dirty environments, an *Army Times* article cites testing data that showed "today's M4 and M4A1 indicate a 98.3 percent probability of completing a mission with a basic ammunition load (209 rounds) without failure." To those supporters cheering on a new small-arms alternative to the AR, the Army scrapped the effort to find a replacement after determining that all of the potential replacements didn't provide sufficient improvements over current performance levels . . . particularly not enough to justify the additional cost it would take to swap out the entire branch's shoulder-fired weapons.

On the civilian front, increasing acceptance by competitive shooters, driven in large part by 3Gun competitors, and certainly hunters, who continue to embrace the platform, are driving high-end performance features on some models and more hunt-friendly features and broader caliber offerings on others. This latter development has been one of the most visible in recent years as manufacturers seek to keep rifles moving off shelves even as buying patterns settle into more stable, yet realistic numbers following the boom years of 2008–09 and 2012–13. But more on that later in the book.



## 4. AR Rifle Models

Following is undoubtedly the most comprehensive listing of current AR-style rifle models available in print or on the web, though it is by no means exhaustive. The knowledgeable reader will no doubt find a favorite small manufacturer or favorite model of gun not listed here. Some companies simply have so many guns, it was impractical to list them all. Others were, for inexplicable reasons other than they were too busy, unable to respond to the authors' requests for information and photography, didn't have adequate information available on their websites (some had no websites) or they themselves didn't even have detailed information on their firearm models available. And admittedly, with so many small gunmakers coming into the fold—and just as quickly falling back out of it, capturing every manufacturer is a target even a custom-built AR couldn't hit.

Speaking of custom builders, many, if they did not make predetermined firearm packages, were not included, but are listed in appendices of this book. Likewise, even AR manufacturers whose firearms are not listed in this chapter are at least listed in an appendix at the back of this book. Please check out GuidetoARs.com frequently for updates on gun listings that were missed in this book, previews of new ARs and accessories coming to the market, tips on getting better performance out of your rifle and for detailed reviews on new AR models coming to a store shelf near you. Also, if you are an AR manufacturer and were not listed, please make us aware of your company and its offerings. Contact us through GuidetoARs.com where we will be happy to include your gun models or accessories and will know how to reach you more directly when working on the next edition of *The Shooter's Bible Guide to AR-15s*.

### 2VETS ARMS 2VA BRAVO

**Action:** semi-auto  
**Stock:** B5 Systems  
**Barrel:** 16-in. 4140 CMOV barrel, 1:7  
**Sights:** A2 front sight base  
**Weight:** N/A  
**Caliber:** .556  
**Magazine:** N/A  
**Features:** Arms 7075-T6 billet side charged upper receiver.  
**MSRP:** ..... \$1,300

### 2VA SOPMOD

**Action:** semi-auto  
**Stock:** B5 Systems  
**Barrel:** 16-in. 416R stainless steel barrel, 1:7 RH twist  
**Sights:** N/A  
**Weight:** N/A  
**Caliber:** 5.56  
**Magazine:** N/A  
**Features:** 7075-T6 billet side charged upper receiver, 7075-T6 billet lower receiver, ALG Defense GI fire controls, carbine gas system, 10-in. quad rail.  
**MSRP:** ..... \$1,499

### 2VA NATO GENESIS SERIES

**Action:** semi-auto  
**Stock:** B5 Systems  
**Barrel:** 13.7-in. barrel, B.E. Meyers 249 flash hider  
**Sights:** N/A  
**Weight:** N/A  
**Caliber:** .556  
**Magazine:** N/A  
**Features:** 2VA 7075 billet A4 upper, 2VA 7075 billet lower, ambi charging handle, M-LOK rail.  
**MSRP:** ..... \$1,575

### 2VA .308 SPECIAL PURPOSE RIFLE

**Action:** semi-auto  
**Stock:** B5 Systems Bravo  
**Barrel:** 18-in., 1:10 RH twist, full fluted 416R stainless match-grade barrel w/ black Nitride finish  
**Sights:** N/A  
**Weight:** 7 lb. 13 oz.  
**Caliber:** .308  
**Magazine:** N/A  
**Features:** 7075-T6 matched set billet receivers, ambidextrous side charging system, ambidextrous safety selector,

two-stage trigger from Geissele Automatics (G2S-E), B5 Systems Bravo collapsible buttstock, 14-in. P3R lightweight free-float rail, 18-in. full fluted 416R stainless match-grade barrel with black Nitride finish.  
**MSRP:** ..... \$1,875

### 2VA ALPHA

**Action:** semi-auto  
**Stock:** B5 SOPMOD Alpha stock, BCM Gunfighter grip  
**Barrel:** 16-in. 416R stainless steel match barrel with full flutes  
**Sights:** N/A  
**Weight:** N/A  
**Caliber:** 5.56  
**Magazine:** N/A  
**Features:** Arms 7075-T6 billet side charged upper receiver, 7075 forged lower receiver, mid-length gas system, Geissele SSA fire controls, KNS anti-rotation pins, Battle Arms Development ambi selector, Phase 5 enhanced side charged compatible BAD lever, 13-in. KeyMod compatible free-float rail.  
**MSRP:** ..... \$1,875

AR RIFLE MODELS



# APPENDIX I—AR MANUFACTURERS

2 Vets Arms  
www.2vetsarms.com

556 Tactical LLC  
www.556tactical.com

**A**  
Accurate Armory  
www.accuratearmory.com

Adams Arms  
www.adamsarms.net

Adcor Defense  
www.adcordefense.com

Aero Precision  
www.Aeroprecisionusa.com

Alexander Arms  
www.Alexanderarms.com

Alex Pro Firearms  
www.apfarmory.com

American Spirit Arms  
www.americanspiritarms.com

American Tactical Imports  
www.americantactical.us

American Firearms Manufacturing  
www.afmco.com

Anderson Manufacturing  
www.andersonrifles.com

AR57 Center  
www.57center.com

Ares Arms  
www.aresarms.com

Ares Defense  
www.aresdefense.com

Arsenal Democracy  
www.arsenaldemocracy.com

ArmaLite  
www.armacite.com

Armscor  
www.armscor.com

Arms Tech Ltd  
www.armstechltd.com

Astra Arms  
www.astra-arms.ch

AXTS Weapons  
www.axtsweapons.com

**B**  
Barnes Precision  
www.usamade-ar15parts.com

Barrett  
www.barrett.net

Battle Born  
www.battlebornusa.com

Battle Rifle Company  
www.battleriflecompany.com

Bazooka Brothers  
www.bazookabrothers.com

BCI Defense  
www.bciddefense.com

Black Heart International  
www.bhigear.com

Black Rain Ordnance  
www.blackrainordnance.com

Black Dawn Armory  
www.blackdawnarms.com

Bradley Arms  
www.bradleyarms.com

Bravo Company USA  
www.bravocompanyusa.com

Bushmaster  
www.bushmaster.com

**C**  
Chattahoochee Gun Works  
www.c-gw.com

Christensen Arms  
www.christensenarms.com

Christian Armory Works  
www.christianarmoryworks.com

CMMG  
www.cmmginc.com

Colt Competition Rifles  
www.coltcompetitionrifle.com

Colt Firearms  
www.colt.com

Compass Lake Engineering  
www.compasslake.com

**D**  
Daniel Defense  
www.deztacticalarms.com

Del-Ton  
www.del-ton.com

DEZ Tactical  
www.deztacticalarms.com

Diamondback Firearms  
www.diamondbackfirearms.com

Double Star  
www.star15.com

DPMS  
www.dpmsinc.com

Dragon Fire Armory  
www.dragonfirearmory.com

Dreadnaught Industries  
www.dreadnaught-industries.com

DSA Arms  
www.dsarms.com

**E**  
Edward Arms  
www.edwardarms.com

Erathr3  
www.erathr3.com

**F**  
Firebird Precision  
www.firebirdprecision.com

Fulton Armory  
www.fulton-armory.com

FNH USA \*\*\*Now FN America\*\*\*\*  
www.fnamerica.com

Franklin Armory  
www.franklinarmory.com

**G**  
GAR Arms  
www.gar-arms.com

**H**  
Hatcher Gun Company  
www.hatchergun.com

Head Down Products  
www.hdfirearms.com  
Hera Arms  
www.hera-arms.com

High Standard Firearms  
www.highstandard.com

HM Defense  
www.hmdefense.com

Heckler & Koch  
www.hk-usa.com

Hogan Guns  
www.hoganguns.com

Huldra Arms  
www.huldraarms.com

**I**  
Integrity Arms  
www.customar15.net

Invincible Arms  
www.invinciblearms.com

Iron Ridge Guns  
www.ironridgeguns.com

**J**  
JARD, Inc.  
www.jardinc.com

Jesse James Firearms  
www.jjfu.com

JP Rifles  
www.jp Rifles.com

**K**  
Kaufmann Tactical Firearms  
www.kt-firearms.com

KE Arms  
www.kearms.com

Knights Armament  
www.knightarmco.com

**L**  
Lancer Systems  
www.lancer-systems.com

Larue Tactical  
www.larue.com

Les Baer  
www.lesbaer.com

Lewis Machine and Tool  
www.lewismachine.net

LWRC  
www.lwrci.com

**M**  
MGI Military  
www.mgi-military.com

MHT Defense  
www.mhtdefense.com

Midwest Industries  
www.midwestindustriesinc.com

MMC Armory  
www.mmcamory.com

Mohawk Armory  
www.mohawkarmory.com

Mossberg  
www.mossberg.com

**N**  
NEMO Arms  
www.nemoarms.com

Noveske Rifleworks  
www.noveske.com

**O**  
Olympic Arms  
www.olyarms.com

**P**  
Palmetto State Defense  
www.palmettostatedefense.com

Patriot Ordnance Factory (POF)  
www.pof-usa.com

PEC Armory  
www.pecarmory.com

Personal Defense Warehouse  
www.pdwarehouse.com

Precision Firearms  
www.precisionfirearms.com

Precision Reflex  
www.precisionreflex.com

Primary Weapons Systems  
www.primaryweapons.com

**Q**  
Quality Arms  
www.qualityarmsidaho.com

Quentin Defense  
www.quentindefense.com

**R**  
Radical Firearms  
www.radicalfirearms.com

Ranger Proof  
www.rangerproof.com

Rebel Arms  
www.rebelarms.com

Red X Arms  
www.shop.redxarms.com

Remington Arms  
www.remington.com

R Guns  
www.rguns.net

RIP Tactical  
www.rip-tactical.com

RND Manufacturing  
www.rndrifles.com

Rock River Arms  
www.rockriverarms.com

Ruger  
www.ruger.com

**S**  
Savannah River Armory  
www.savannahriverarmory.com

Schmeisser Germany  
www.schmeisser-germany.de

Seekins Precision  
www.seekinsprecision.com

SLR15 Rifles  
www.slr15rifles.com

Sharps Rifle Company  
www.srcarms.com

SI Defense  
www.si-defense.com

Signature Manufacturing  
www.signaturemanufactures.com

Sig Sauer  
www.sigsauer.com

Sionics Weapon Systems  
www.sionicsweaponsystems.com

Smith & Wesson  
www.smith-wesson.com

Specialized Dynamics  
www.specializeddynamics.com

Specialized Tactical Systems  
www.specializedtactical.com

Spikes Tactical  
www.spikestactical.com

Stag Arms  
www.stagarms.com

Sterling Arsenal  
www.sterlingarsenal.com

Stubborn Mule Outdoor Supply  
www.smosarms.com

Surplus Ammo and Arms  
www.surplusammo.com

Superior Arms  
www.superiorarms.com

S.W.O.R.D. International  
www.sword-int.com

**T**  
Tactical Arms Manufacturer  
www.tacticalarmsmfr.com

Tactical Firearms Solutions  
www.tfsarms.com

Teppo Jutsu  
www.teppojutsu.com

Texas Black Rifle Company  
www.tbrci.com  
Texas Custom Guns

www.texascustomguns.net

Thor Global Defense  
www.thorgdg.com

TNW Firearms  
www.tnwfirearms.com

TR Enabling  
www.tr-enabling.com

Trident Arms  
www.tridentarms.us

**U**  
USA Tactical Firearms  
www.usatf.us

**V**  
Valkyrie Armament  
www.beltfedar.com

Vltor Weapon Systems  
www.vltor.com

Vidalia Police Supply  
www.kavodcustom.com

**W**  
War Sport Industries  
www.warsport-us.net

Wilson Combat  
www.wilsoncombat.com

Windham Weaponry  
www.windhamweaponry.com

**X**  
Xtreme Machining  
www.xtrememachining.biz

**Y**  
Yankee Hill Machine  
www.yhm.net



Sports/Shooting

US \$19.99/Can \$26.99

## THE MOST RECENT INFORMATION AND SPECS ON THE POPULAR AR-15 RIFLE

There's no denying the popularity and intense fascination with AR-15s among firearms enthusiasts today. Interest has grown rapidly over the past decade, spurred by the versatility of modern sporting rifles in addition to increased performance. Here, inside the most comprehensive source to date in a newly updated second edition, is Doug Howlett and Robb Manning's expert approach to everything from the intriguing history of the AR to breaking down the weapon piece by piece, choosing ammunition, and even building your own gun.

In this complete book of AR-style firearms, you can peruse the products of all manufacturers, learn about the evolution of the AR from its uses in the military in the 1960s as well as gain essential knowledge on the parts and functions of the rifle. Also included are chapters on customizing and accessorizing ARs, and much more.

**DOUG HOWLETT** is an award-winning editor and writer who grew up hunting and shooting. He began his writing career as a newspaper reporter before combining his passions for writing and the outdoors at the National Rifle Association, where he worked as assistant editor of *American Hunter* magazine. He has served as editor-in-chief of *Turkey Call* magazine at the National Wild Turkey Federation, as well as deputy editor at *Outdoor Life* magazine in New York City. It was on a hunt he covered for *Outdoor Life* that he discovered the absolute thrill of hunting with modern tactical rifles.

**ROBB MANNING** grew up in southern Wisconsin before enlisting in the US Marine Corps, where he served for nearly eleven years. During this time, he developed a passion and knowledge for firearms of all types. Robb has been writing professionally since 2010, and his work has appeared in *AR Guns & Hunting*, *Predator Xtreme*, *Gun Digest*, and *Modern Shooter*. He currently has two reoccurring columns in *On Wisconsin Outdoors* newspaper and is the author of the *Glock Quick Reference Guide* and the current editor of *Gun World* magazine.

### ALSO AVAILABLE

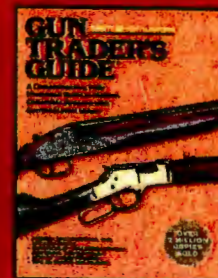
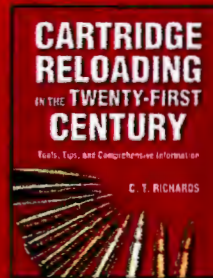
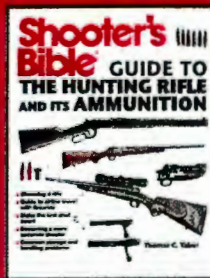
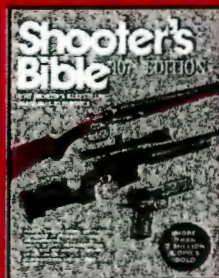

 Skyhorse Publishing, Inc.  
New York, New York  
[www.skyhorsepublishing.com](http://www.skyhorsepublishing.com)

Cover design by Brian Peterson  
Printed in China





# Exhibit A-7



# Illinois General Assembly

Home Legislation & Laws Senate House My Legislation Site Map

- Bills & Resolutions
- Compiled Statutes
- Public Acts
- Legislative Reports
- IL Constitution
- Legislative Guide
- Legislative Glossary

## Illinois Compiled Statutes

[ILCS Listing](#) [Public Acts](#) [Search](#) [Guide](#) [Disclaimer](#)

### Information maintained by the Legislative Reference Bureau

Updating the database of the Illinois Compiled Statutes (ILCS) is an ongoing process. Recent laws may not yet be included in the ILCS database, but they are found on this site as [Public Acts](#) soon after they become law. For information concerning the relationship between statutes and Public Acts, refer to the [Guide](#).

Because the statute database is maintained primarily for legislative drafting purposes, statutory changes are sometimes included in the statute database before they take effect. If the source note at the end of a Section of the statutes includes a Public Act that has not yet taken effect, the version of the law that is currently in effect may have already been removed from the database and you should refer to that Public Act to see the changes made to the current law.

Search By Number  
(example: HB0001)

Go [Search Tips](#)

Search By Keyword

Go [Search Tips](#)

[Advanced Search](#)



(720 ILCS 5/24-1.9)

Sec. 24-1.9. Manufacture, possession, delivery, sale, and purchase of assault weapons, .50 caliber rifles, and .50 caliber cartridges.

(a) Definitions. In this Section:

(1) "Assault weapon" means any of the following, except as provided in subdivision (2) of this subsection:

(A) A semiautomatic rifle that has the capacity to accept a detachable magazine or that may be readily modified to accept a detachable magazine, if the firearm has one or more of the following:

- (i) a pistol grip or thumbhole stock;
- (ii) any feature capable of functioning as a protruding grip that can be held by the non-trigger hand;
- (iii) a folding, telescoping, thumbhole, or detachable stock, or a stock that is otherwise foldable or adjustable in a manner that operates to reduce the length, size, or any other dimension, or otherwise enhances the concealability of, the weapon;
- (iv) a flash suppressor;
- (v) a grenade launcher;
- (vi) a shroud attached to the barrel or that partially or completely encircles the barrel, allowing the bearer to hold the firearm with the non-trigger hand without being burned, but excluding a slide that encloses the barrel.

(B) A semiautomatic rifle that has a fixed magazine with the capacity to accept more than 10 rounds, except for an attached tubular device designed to accept, and capable of operating only with, .22 caliber rimfire ammunition.

(C) A semiautomatic pistol that has the capacity to accept a detachable magazine or that may be readily modified to accept a detachable magazine, if the firearm has one or more of the following:

- (i) a threaded barrel;
- (ii) a second pistol grip or another feature capable of functioning as a protruding grip that can be held by the non-trigger hand;
- (iii) a shroud attached to the barrel or that

9/27/23, 2:54 PM

## Illinois General Assembly - Illinois Compiled Statutes

partially or completely encircles the barrel, allowing the bearer to hold the firearm with the non-trigger hand without being burned, but excluding a slide that encloses the barrel;

(iv) a flash suppressor;

(v) the capacity to accept a detachable magazine at some location outside of the pistol grip; or

(vi) a buffer tube, arm brace, or other part that protrudes horizontally behind the pistol grip and is designed or redesigned to allow or facilitate a firearm to be fired from the shoulder.

(D) A semiautomatic pistol that has a fixed magazine with the capacity to accept more than 15 rounds.

(E) Any shotgun with a revolving cylinder.

(F) A semiautomatic shotgun that has one or more of the following:

(i) a pistol grip or thumbhole stock;

(ii) any feature capable of functioning as a protruding grip that can be held by the non-trigger hand;

(iii) a folding or thumbhole stock;

(iv) a grenade launcher;

(v) a fixed magazine with the capacity of more than 5 rounds; or

(vi) the capacity to accept a detachable magazine.

(G) Any semiautomatic firearm that has the capacity to accept a belt ammunition feeding device.

(H) Any firearm that has been modified to be operable as an assault weapon as defined in this Section.

(I) Any part or combination of parts designed or intended to convert a firearm into an assault weapon, including any combination of parts from which an assault weapon may be readily assembled if those parts are in the possession or under the control of the same person.

(J) All of the following rifles, copies, duplicates, variants, or altered facsimiles with the capability of any such weapon:

(i) All AK types, including the following:

(I) AK, AK47, AK47S, AK-74, AKM, AKS, ARM, MAK90, MISR, NHM90, NHM91, SA85, SA93, Vector Arms AK-47, VEPR, WASR-10, and WUM.

(II) IZHMASH Saiga AK.

(III) MAADI AK47 and ARM.

(IV) Norinco 56S, 56S2, 84S, and 86S.

(V) Poly Technologies AK47 and AKS.

(VI) SKS with a detachable magazine.

(ii) all AR types, including the following:

(I) AR-10.

(II) AR-15.

(III) Alexander Arms Overmatch Plus 16.

(IV) Armalite M15 22LR Carbine.

(V) Armalite M15-T.

(VI) Barrett REC7.

(VII) Beretta AR-70.

(VIII) Black Rain Ordnance Recon Scout.

(IX) Bushmaster ACR.

(X) Bushmaster Carbon 15.

(XI) Bushmaster MOE series.

(XII) Bushmaster XM15.

(XIII) Chiappa Firearms MFour rifles.

(XIV) Colt Match Target rifles.



9/27/23, 2:54 PM

## Illinois General Assembly - Illinois Compiled Statutes

- (XV) CORE Rifle Systems CORE15 rifles.
- (XVI) Daniel Defense M4A1 rifles.
- (XVII) Devil Dog Arms 15 Series rifles.
- (XVIII) Diamondback DB15 rifles.
- (XIX) DoubleStar AR rifles.
- (XX) DPMS Tactical rifles.
- (XXI) DSA Inc. ZM-4 Carbine.
- (XXII) Heckler & Koch MR556.
- (XXIII) High Standard HSA-15 rifles.
- (XXIV) Jesse James Nomad AR-15 rifle.
- (XXV) Knight's Armament SR-15.
- (XXVI) Lancer L15 rifles.
- (XXVII) MGI Hydra Series rifles.
- (XXVIII) Mossberg MMR Tactical rifles.
- (XXIX) Noreen Firearms BN 36 rifle.
- (XXX) Olympic Arms.
- (XXXI) POF USA P415.
- (XXXII) Precision Firearms AR rifles.
- (XXXIII) Remington R-15 rifles.
- (XXXIV) Rhino Arms AR rifles.
- (XXXV) Rock River Arms LAR-15 or Rock River Arms LAR-47.
- (XXXVI) Sig Sauer SIG516 rifles and MCX rifles.
- (XXXVII) Smith & Wesson M&P15 rifles.
- (XXXVIII) Stag Arms AR rifles.
- (XXXIX) Sturm, Ruger & Co. SR556 and AR-556 rifles.
- (XL) Uselton Arms Air-Lite M-4 rifles.
- (XLI) Windham Weaponry AR rifles.
- (XLII) WMD Guns Big Beast.
- (XLIII) Yankee Hill Machine Company, Inc. YHM-15 rifles.
- (iii) Barrett M107A1.
- (iv) Barrett M82A1.
- (v) Beretta CX4 Storm.
- (vi) Calico Liberty Series.
- (vii) CETME Sporter.
- (viii) Daewoo K-1, K-2, Max 1, Max 2, AR 100, and AR 110C.
- (ix) Fabrique Nationale/FN Herstal FAL, LAR, 22 FNC, 308 Match, L1A1 Sporter, PS90, SCAR, and FS2000.
- (x) Feather Industries AT-9.
- (xi) Galil Model AR and Model ARM.
- (xii) Hi-Point Carbine.
- (xiii) HK-91, HK-93, HK-94, HK-PSG-1, and HK USC.
- (xiv) IWI TAVOR, Galil ACE rifle.
- (xv) Kel-Tec Sub-2000, SU-16, and RFB.
- (xvi) SIG AMT, SIG PE-57, Sig Sauer SG 550, Sig Sauer SG 551, and SIG MCX.
- (xvii) Springfield Armory SAR-48.
- (xviii) Steyr AUG.
- (xix) Sturm, Ruger & Co. Mini-14 Tactical Rifle M-14/20CF.
- (xx) All Thompson rifles, including the following:
  - (I) Thompson M1SB.
  - (II) Thompson T1100D.
  - (III) Thompson T150D.
  - (IV) Thompson T1B.
  - (V) Thompson T1B100D.

9/27/23, 2:54 PM

## Illinois General Assembly - Illinois Compiled Statutes

- (VI) Thompson T1B50D.
- (VII) Thompson T1BSB.
- (VIII) Thompson T1-C.
- (IX) Thompson T1D.
- (X) Thompson T1SB.
- (XI) Thompson T5.
- (XII) Thompson T5100D.
- (XIII) Thompson TM1.
- (XIV) Thompson TM1C.

(xxi) UMAREX UZI rifle.

(xxii) UZI Mini Carbine, UZI Model A Carbine, and UZI Model B Carbine.

(xxiii) Valmet M62S, M71S, and M78.

(xxiv) Vector Arms UZI Type.

(xxv) Weaver Arms Nighthawk.

(xxvi) Wilkinson Arms Linda Carbine.

(K) All of the following pistols, copies, duplicates, variants, or altered facsimiles with the capability of any such weapon thereof:

(i) All AK types, including the following:

- (I) Centurion 39 AK pistol.
- (II) CZ Scorpion pistol.
- (III) Draco AK-47 pistol.
- (IV) HCR AK-47 pistol.
- (V) IO Inc. Hellpup AK-47 pistol.
- (VI) Krinkov pistol.
- (VII) Mini Draco AK-47 pistol.
- (VIII) PAP M92 pistol.
- (IX) Yugo Krebs Krink pistol.

(ii) All AR types, including the following:

- (I) American Spirit AR-15 pistol.
- (II) Bushmaster Carbon 15 pistol.
- (III) Chiappa Firearms M4 Pistol GEN II.
- (IV) CORE Rifle Systems CORE15 Roscoe pistol.
- (V) Daniel Defense MK18 pistol.
- (VI) DoubleStar Corporation AR pistol.
- (VII) DPMS AR-15 pistol.
- (VIII) Jesse James Nomad AR-15 pistol.
- (IX) Olympic Arms AR-15 pistol.
- (X) Osprey Armament MK-18 pistol.
- (XI) POF USA AR pistols.
- (XII) Rock River Arms LAR 15 pistol.
- (XIII) Uselton Arms Air-Lite M-4 pistol.

(iii) Calico pistols.

(iv) DSA SA58 PKP FAL pistol.

(v) Encom MP-9 and MP-45.

(vi) Heckler & Koch model SP-89 pistol.

(vii) Intratec AB-10, TEC-22 Scorpion, TEC-9, and TEC-DC9.

(viii) IWI Galil Ace pistol, UZI PRO pistol.

(ix) Kel-Tec PLR 16 pistol.

(x) All MAC types, including the following:

(I) MAC-10.

(II) MAC-11.

(III) Masterpiece Arms MPA A930 Mini Pistol, MPA460 Pistol, MPA Tactical Pistol, and MPA Mini Tactical Pistol.

(IV) Military Armament Corp. Ingram M-11.

(V) Velocity Arms VMAC.

(xi) Sig Sauer P556 pistol.

9/27/23, 2:54 PM

## Illinois General Assembly - Illinois Compiled Statutes

- (xii) Sites Spectre.
- (xiii) All Thompson types, including the following:
  - (I) Thompson TA510D.
  - (II) Thompson TA5.
- (xiv) All UZI types, including Micro-UZI.
- (L) All of the following shotguns, copies, duplicates, variants, or altered facsimiles with the capability of any such weapon thereof:
  - (i) DERYA Anakon MC-1980, Anakon SD12.
  - (ii) Doruk Lethal shotguns.
  - (iii) Franchi LAW-12 and SPAS 12.
  - (iv) All IZHMASH Saiga 12 types, including the following:
    - (I) IZHMASH Saiga 12.
    - (II) IZHMASH Saiga 12S.
    - (III) IZHMASH Saiga 12S EXP-01.
    - (IV) IZHMASH Saiga 12K.
    - (V) IZHMASH Saiga 12K-030.
    - (VI) IZHMASH Saiga 12K-040 Taktika.
  - (v) Streetsweeper.
  - (vi) Striker 12.
- (2) "Assault weapon" does not include:
  - (A) Any firearm that is an unserviceable firearm or has been made permanently inoperable.
  - (B) An antique firearm or a replica of an antique firearm.
  - (C) A firearm that is manually operated by bolt, pump, lever or slide action, unless the firearm is a shotgun with a revolving cylinder.
  - (D) Any air rifle as defined in Section 24.8-0.1 of this Code.
  - (E) Any handgun, as defined under the Firearm Concealed Carry Act, unless otherwise listed in this Section.
- (3) "Assault weapon attachment" means any device capable of being attached to a firearm that is specifically designed for making or converting a firearm into any of the firearms listed in paragraph (1) of this subsection (a).
- (4) "Antique firearm" has the meaning ascribed to it in 18 U.S.C. 921(a)(16).
- (5) ".50 caliber rifle" means a centerfire rifle capable of firing a .50 caliber cartridge. The term does not include any antique firearm, any shotgun including a shotgun that has a rifle barrel, or any muzzle-loader which uses black powder for hunting or historical reenactments.
- (6) ".50 caliber cartridge" means a cartridge in .50 BMG caliber, either by designation or actual measurement, that is capable of being fired from a centerfire rifle. The term ".50 caliber cartridge" does not include any memorabilia or display item that is filled with a permanent inert substance or that is otherwise permanently altered in a manner that prevents ready modification for use as live ammunition or shotgun ammunition with a caliber measurement that is equal to or greater than .50 caliber.
- (7) "Detachable magazine" means an ammunition feeding device that may be removed from a firearm without disassembly of the firearm action, including an ammunition feeding device that may be readily removed from a firearm with the use of a bullet, cartridge, accessory, or other tool, or any other object that functions as a tool, including a bullet or cartridge.
- (8) "Fixed magazine" means an ammunition feeding device that is permanently attached to a firearm, or contained in and not



9/27/23, 2:54 PM

## Illinois General Assembly - Illinois Compiled Statutes

removable from a firearm, or that is otherwise not a detachable magazine, but does not include an attached tubular device designed to accept, and capable of operating only with, .22 caliber rimfire ammunition.

(b) Except as provided in subsections (c), (d), and (e), on or after the effective date of this amendatory Act of the 102nd General Assembly, it is unlawful for any person within this State to knowingly manufacture, deliver, sell, import, or purchase or cause to be manufactured, delivered, sold, imported, or purchased by another, an assault weapon, assault weapon attachment, .50 caliber rifle, or .50 caliber cartridge.

(c) Except as otherwise provided in subsection (d), beginning January 1, 2024, it is unlawful for any person within this State to knowingly possess an assault weapon, assault weapon attachment, .50 caliber rifle, or .50 caliber cartridge.

(d) This Section does not apply to a person's possession of an assault weapon, assault weapon attachment, .50 caliber rifle, or .50 caliber cartridge device if the person lawfully possessed that assault weapon, assault weapon attachment, .50 caliber rifle, or .50 caliber cartridge prohibited by subsection (c) of this Section, if the person has provided in an endorsement affidavit, prior to January 1, 2024, under oath or affirmation and in the form and manner prescribed by the Illinois State Police, no later than October 1, 2023:

(1) the affiant's Firearm Owner's Identification Card number;

(2) an affirmation that the affiant: (i) possessed an assault weapon, assault weapon attachment, .50 caliber rifle, or .50 caliber cartridge before the effective date of this amendatory Act of the 102nd General Assembly; or (ii) inherited the assault weapon, assault weapon attachment, .50 caliber rifle, or .50 caliber cartridge from a person with an endorsement under this Section or from a person authorized under subdivisions (1) through (5) of subsection (e) to possess the assault weapon, assault weapon attachment, .50 caliber rifle, or .50 caliber cartridge; and

(3) the make, model, caliber, and serial number of the .50 caliber rifle or assault weapon or assault weapons listed in paragraphs (J), (K), and (L) of subdivision (1) of subsection (a) of this Section possessed by the affiant prior to the effective date of this amendatory Act of the 102nd General Assembly and any assault weapons identified and published by the Illinois State Police pursuant to this subdivision (3). No later than October 1, 2023, and every October 1 thereafter, the Illinois State Police shall, via rulemaking, identify, publish, and make available on its website, the list of assault weapons subject to an endorsement affidavit under this subsection (d). The list shall identify, but is not limited to, the copies, duplicates, variants, and altered facsimiles of the assault weapons identified in paragraphs (J), (K), and (L) of subdivision (1) of subsection (a) of this Section and shall be consistent with the definition of "assault weapon" identified in this Section. The Illinois State Police may adopt emergency rulemaking in accordance with Section 5-45 of the Illinois Administrative Procedure Act. The adoption of emergency rules authorized by Section 5-45 of the Illinois Administrative Procedure Act and this paragraph is deemed to be necessary for the public interest, safety, and welfare.

The affidavit form shall include the following statement printed in bold type: "Warning: Entering false information on this form is punishable as perjury under Section 32-2 of the Criminal Code of 2012. Entering false information on this form

9/27/23, 2:54 PM

## Illinois General Assembly - Illinois Compiled Statutes

is a violation of the Firearm Owners Identification Card Act."

In any administrative, civil, or criminal proceeding in this State, a completed endorsement affidavit submitted to the Illinois State Police by a person under this Section creates a rebuttable presumption that the person is entitled to possess and transport the assault weapon, assault weapon attachment, .50 caliber rifle, or .50 caliber cartridge.

Beginning 90 days after the effective date of this amendatory Act of the 102nd General Assembly, a person authorized under this Section to possess an assault weapon, assault weapon attachment, .50 caliber rifle, or .50 caliber cartridge shall possess such items only:

- (1) on private property owned or immediately controlled by the person;
- (2) on private property that is not open to the public with the express permission of the person who owns or immediately controls such property;
- (3) while on the premises of a licensed firearms dealer or gunsmith for the purpose of lawful repair;
- (4) while engaged in the legal use of the assault weapon, assault weapon attachment, .50 caliber rifle, or .50 caliber cartridge at a properly licensed firing range or sport shooting competition venue; or
- (5) while traveling to or from these locations, provided that the assault weapon, assault weapon attachment, or .50 caliber rifle is unloaded and the assault weapon, assault weapon attachment, .50 caliber rifle, or .50 caliber cartridge is enclosed in a case, firearm carrying box, shipping box, or other container.

Beginning on January 1, 2024, the person with the endorsement for an assault weapon, assault weapon attachment, .50 caliber rifle, or .50 caliber cartridge or a person authorized under subdivisions (1) through (5) of subsection (e) to possess an assault weapon, assault weapon attachment, .50 caliber rifle, or .50 caliber cartridge may transfer the assault weapon, assault weapon attachment, .50 caliber rifle, or .50 caliber cartridge only to an heir, an individual residing in another state maintaining it in another state, or a dealer licensed as a federal firearms dealer under Section 923 of the federal Gun Control Act of 1968. Within 10 days after transfer of the weapon except to an heir, the person shall notify the Illinois State Police of the name and address of the transferee and comply with the requirements of subsection (b) of Section 3 of the Firearm Owners Identification Card Act. The person to whom the weapon or ammunition is transferred shall, within 60 days of the transfer, complete an affidavit required under this Section. A person to whom the weapon is transferred may transfer it only as provided in this subsection.

Except as provided in subsection (e) and beginning on January 1, 2024, any person who moves into this State in possession of an assault weapon, assault weapon attachment, .50 caliber rifle, or .50 caliber cartridge shall, within 60 days, apply for a Firearm Owners Identification Card and complete an endorsement application as outlined in subsection (d).

Notwithstanding any other law, information contained in the endorsement affidavit shall be confidential, is exempt from disclosure under the Freedom of Information Act, and shall not be disclosed, except to law enforcement agencies acting in the performance of their duties.

(e) The provisions of this Section regarding the purchase or possession of assault weapons, assault weapon attachments, .50 caliber rifles, and .50 cartridges, as well as the provisions of this Section that prohibit causing those items to be purchased



9/27/23, 2:54 PM

## Illinois General Assembly - Illinois Compiled Statutes

or possessed, do not apply to:

(1) Peace officers, as defined in Section 2-13 of this Code.

(2) Qualified law enforcement officers and qualified retired law enforcement officers as defined in the Law Enforcement Officers Safety Act of 2004 (18 U.S.C. 926B and 926C) and as recognized under Illinois law.

(3) Acquisition and possession by a federal, State, or local law enforcement agency for the purpose of equipping the agency's peace officers as defined in paragraph (1) or (2) of this subsection (e).

(4) Wardens, superintendents, and keepers of prisons, penitentiaries, jails, and other institutions for the detention of persons accused or convicted of an offense.

(5) Members of the Armed Services or Reserve Forces of the United States or the Illinois National Guard, while performing their official duties or while traveling to or from their places of duty.

(6) Any company that employs armed security officers in this State at a nuclear energy, storage, weapons, or development site or facility regulated by the federal Nuclear Regulatory Commission and any person employed as an armed security force member at a nuclear energy, storage, weapons, or development site or facility regulated by the federal Nuclear Regulatory Commission who has completed the background screening and training mandated by the rules and regulations of the federal Nuclear Regulatory Commission and while performing official duties.

(7) Any private security contractor agency licensed under the Private Detective, Private Alarm, Private Security, Fingerprint Vendor, and Locksmith Act of 2004 that employs private security contractors and any private security contractor who is licensed and has been issued a firearm control card under the Private Detective, Private Alarm, Private Security, Fingerprint Vendor, and Locksmith Act of 2004 while performing official duties.

The provisions of this Section do not apply to the manufacture, delivery, sale, import, purchase, or possession of an assault weapon, assault weapon attachment, .50 caliber rifle, or .50 caliber cartridge or causing the manufacture, delivery, sale, importation, purchase, or possession of those items:

(A) for sale or transfer to persons authorized under subdivisions (1) through (7) of this subsection (e) to possess those items;

(B) for sale or transfer to the United States or any department or agency thereof; or

(C) for sale or transfer in another state or for export.

This Section does not apply to or affect any of the following:

(i) Possession of any firearm if that firearm is sanctioned by the International Olympic Committee and by USA Shooting, the national governing body for international shooting competition in the United States, but only when the firearm is in the actual possession of an Olympic target shooting competitor or target shooting coach for the purpose of storage, transporting to and from Olympic target shooting practice or events if the firearm is broken down in a nonfunctioning state, is not immediately accessible, or is unloaded and enclosed in a firearm case, carrying box, shipping box, or other similar portable container designed for the safe transportation of firearms, and when the Olympic target shooting competitor or target shooting coach is engaging in those practices or events. For the purposes



9/27/23, 2:54 PM

## Illinois General Assembly - Illinois Compiled Statutes

of this paragraph (8), "firearm" has the meaning provided in Section 1.1 of the Firearm Owners Identification Card Act.

(ii) Any nonresident who transports, within 24 hours, a weapon for any lawful purpose from any place where the nonresident may lawfully possess and carry that weapon to any other place where the nonresident may lawfully possess and carry that weapon if, during the transportation, the weapon is unloaded, and neither the weapon nor any ammunition being transported is readily accessible or is directly accessible from the passenger compartment of the transporting vehicle. In the case of a vehicle without a compartment separate from the driver's compartment, the weapon or ammunition shall be contained in a locked container other than the glove compartment or console.

(iii) Possession of a weapon at an event taking place at the World Shooting and Recreational Complex at Sparta, only while engaged in the legal use of the weapon, or while traveling to or from that location if the weapon is broken down in a nonfunctioning state, is not immediately accessible, or is unloaded and enclosed in a firearm case, carrying box, shipping box, or other similar portable container designed for the safe transportation of firearms.

(iv) Possession of a weapon only for hunting use expressly permitted under the Wildlife Code, or while traveling to or from a location authorized for this hunting use under the Wildlife Code if the weapon is broken down in a nonfunctioning state, is not immediately accessible, or is unloaded and enclosed in a firearm case, carrying box, shipping box, or other similar portable container designed for the safe transportation of firearms. By October 1, 2023, the Illinois State Police, in consultation with the Department of Natural Resources, shall adopt rules concerning the list of applicable weapons approved under this subparagraph (iv). The Illinois State Police may adopt emergency rules in accordance with Section 5-45 of the Illinois Administrative Procedure Act. The adoption of emergency rules authorized by Section 5-45 of the Illinois Administrative Procedure Act and this paragraph is deemed to be necessary for the public interest, safety, and welfare.

(v) The manufacture, transportation, possession, sale, or rental of blank-firing assault weapons and .50 caliber rifles, or the weapon's respective attachments, to persons authorized or permitted, or both authorized and permitted, to acquire and possess these weapons or attachments for the purpose of rental for use solely as props for a motion picture, television, or video production or entertainment event.

Any person not subject to this Section may submit an endorsement affidavit if the person chooses.

(f) Any sale or transfer with a background check initiated to the Illinois State Police on or before the effective date of this amendatory Act of the 102nd General Assembly is allowed to be completed after the effective date of this amendatory Act once an approval is issued by the Illinois State Police and any applicable waiting period under Section 24-3 has expired.

(g) The Illinois State Police shall take all steps necessary to carry out the requirements of this Section within by October 1, 2023.

(h) The Department of the State Police shall also develop and implement a public notice and public outreach campaign to promote awareness about the provisions of this amendatory Act of the 102nd General Assembly and to increase compliance with this Section.

(Source: P.A. 102-1116, eff. 1-10-23.)

9/27/23, 2:54 PM

Illinois General Assembly - Illinois Compiled Statutes

---

[Home](#) | [Legislation & Laws](#) | [House](#) | [Senate](#) | [My Legislation](#) | [Disclaimers](#) | [Email](#)

---



This site is maintained for the Illinois General Assembly by the  
Legislative Information System, 705 Stratton Building, Springfield, Illinois 62706  
[Contact ILGA Webmaster](#)

# Exhibit A-8





9/25/23, 7:56 PM

Daniel Defense, M4, Carbine, V7, 5.56 | Daniel Defense

SEARCH



View Compared (0)

# DDM4® V7®

SKU#: 02-128-10290-047 FDE

## \$2,098.00

[APPLY NOW](#)

GET FINANCING FOR AS LOW AS \$68.93 PER MONTH



	<b>FDE</b> <i>In Stock</i>
--	-------------------------------

	<b>COBALT</b> <i>In Stock</i>
--	----------------------------------

	<b>BLACK</b> <i>In Stock</i>
--	---------------------------------

	<b>DANIEL DEFENSE TORNADO®</b> <i>In Stock</i>
--	---

	<b>DEEP WOODS®</b> <i>In Stock</i>
--	---------------------------------------



**MIL SPEC+®**  
In Stock



**RATTLECAN®**  
In Stock

1

**ADD TO CART**

**ADD TO WISH LIST**

**ADD TO COMPARE**

[FIND A LOCAL DEALER](#)

## DETAILS

The DDM4 V7 AR15 style firearm features M-LOK attachment technology with the Daniel Defense MFR 15.0 rail. Built around a Cold Hammer Forged, 16 inch barrel, the V7 has a DD improved Flash Suppressor to reduce flash signature. The mid-length gas system provides smooth and reliable cycling under any condition and reduces both perceived recoil and wear on moving parts. With the M-LOK attachment points that run along 7 positions and an uninterrupted 1913 Picatinny rail on top, the V7 has plenty of room for the sights, optics, and accessories the user may require. The independently ambi GRIP-N-RIP Charging Handle accommodates left- and right-handed shooters. This rifle also comes with the ergonomic Daniel Defense Buttstock and Pistol Grip.

### Product Spotlight: The DDM4V7



#### MATERIALS & CONSTRUCTION

- + LOWER RECEIVER: Mil-Spec with Enhanced Flared Magazine Well and Rear Receiver QD Swivel Attachment Point. CNC Machined of 7075-T6 Aluminum, Type III Hard Coat Anodized
- + UPPER RECEIVER: Mil-Spec with Indexing Marks and M4 Feed Ramps. CNC Machined of 7075-T6 Aluminum, Type III Hard Coat Anodized
- + BARREL: Chrome Moly Vanadium Steel, Cold Hammer Forged, 1:7 Twist, 16" Government Profile, Mid-length Gas System, Chrome Lined, Mil-Spec Heavy Phosphate Coated, and HP/MPI Tested
- + GAS SYSTEM: Pinned Low Profile Gas Block CNC Machined of 4140 hardened steel and Mil-Spec Heavy Phosphate Coating, Mid-length, Direct Impingement
- + MUZZLE DEVICE: Daniel Defense Flash Suppressor, 17-4 PH Stainless Steel, Salt Bath Nitride Finished
- + BOLT CARRIER GROUP: M16 Profile, Mil-Spec MP Tested, Chrome Lined, Properly Staked Gas Key

## SPECIFICATIONS

<b>Mounting System:</b>	M-LOK
<b>Caliber:</b>	5.56mm NATO
<b>Muzzle Thread:</b>	1 / 2 x 28 TPI (Threads Per Inch)
<b>Gas System:</b>	Mid-length
<b>Barrel Length:</b>	16"
<b>Barrel Profile:</b>	Government
<b>Product Weight:</b>	6.2 LBS
<b>Length:</b>	32 1/4" - 35 7/8"
<b>Magazine:</b>	DD Magazine
<b>Case:</b>	Daniel Defense Full-Latch Impact Plastic Case
<b>Manufacturer:</b>	Daniel Defense

## RELATED POSTS

1. [Predator Hunting with a DDM4V7](#)
2. [Shoot Point Blank Spotlights Daniel Defense](#)
3. [Register to win a V7](#)
4. [7 Benefits of an M-LOK Rail](#)

9/25/23, 7:56 PM

Daniel Defense, M4, Carbine, V7, 5.56 | Daniel Defense

- + BUFFER: H Buffer
- + SIGHTS: Sold Separately
- + HANDGUARD: Daniel Defense MFR 15.0, CNC Machined of 6061-T6 Aluminum, M-LOK Attachment, Type III Hard Coat Anodized
- + CHARGING HANDLE: GRIP-N-RIP Charging Handle, Body CNC Machined of 7075-T6 Aluminum, Handles & Latch CNC Machined of 6061-T6 Aluminum, Heavy Duty Stainless Steel Roll Pins, Type III Hard Coat Anodized
- + RECEIVER EXTENSION: 6 Position Mil-Spec 7075-T6 Aluminum
- + BUTTSTOCK: Daniel Defense Buttstock, Glass Filled Polymer with Soft Touch Overmolding
- + PISTOL GRIP: Daniel Defense Pistol Grip, Glass Filled Polymer with Soft Touch Overmolding
- + Made in the USA!

## COMPATIBLE ACCESSORIES

**DD MAGAZINE®**  
\$22.00



ADD TO CART

**M-LOK PICATINNY RAIL SECTION**  
\$33.00



ADD TO CART

**M-LOK SCOUT LIGHT® MOUNT**  
\$51.00



ADD TO CART

**AR-15 IRON SIGHT SET (ROCK & LOCK®)**  
\$142.00



ADD TO CART

## FEATURES





9/25/23, 7:56 PM

Daniel Defense, M4, Carbine, V7, 5.56 | Daniel Defense



**1 MUZZLE DEVICE**

Improved design reduces flash signature compared to the traditional A2 birdcage for AR15 style firearms



**2 COLD-HAMMER FORGED BARREL**

Intense hydraulic pressure process that forms the most accurate and longest-lasting barrels attainable



**3 FLARED MAGAZINE WELL**

Widened and beveled magwell funnels magazines into place for the fastest, most secure reloads possible



**4 AMBI SAFETY SELECTOR**

For right or left-handed shooters



**5 FREE FLOAT RAIL SYSTEM**

Proprietary 4- or 6-bolt attachment to the upper receiver allows the rail system to free float the barrel, which will ensure barrel harmonics are not affected during operation



**6 BUTTSTOCK**

Features a nonslip cheek weld, interchangeable butt pads, and an integral QD point



**7 QD POINTS**

Integrated quick-disconnect points for the attachment of slings



**8 M-LOK**

Features M-LOK attachment technology



**9 PISTOL GRIP**

Ergonomic wrist angle, integral trigger guard and nonslip grip for comfort and control in all conditions

## GUARANTEED SATISFACTION

All Daniel Defense products carry a 100% satisfaction guarantee against defects in original materials and workmanship. If your Daniel Defense product shows evidence of such defects, Daniel Defense will make every accommodation to fix, repair, or replace your product in the most expeditious manner possible. Daniel Defense does not warranty products or damage caused to our products by the correct or incorrect installation of other manufacturer's products.

## CUSTOMER REVIEWS

★★★★★ [46 Reviews](#) [Add Your Review](#)

### TERRIFIC WEAPON

OVERALL ★★★★★

After looking at many AR style 556 rifles including Ruger, Sig, Savage and others, I settled on the DDM4V7 MilSpec version. The action and smooth operation right out of the box impressed me. I like the ergonomic inserts on the stock, grip and handle. It just felt better than the others. I mated it with a 1-4 24mm Trijicon scope. The two together was considerably more expensive than others I looked at. But wow. I bore sighted the scope and then took it to the range. The first three rounds were touching each other at 50 yards about an inch below the bull. After one adjustment I put every follow up round dead in the bullseye. In ten shots I virtually eliminated the center bull and was shooting through the hole on subsequent rounds. My only complaint was the trigger pull. It is a MilSpec trigger with a hefty 7lb pull. Ok for the field but not great for precision shooting. But I knew this going in, so I don't discount my rating because that is what is was supposed to be. I did remove the factory trigger and dropped in a Timney single stage trigger set at 2.7lb. I am truly amazed at the accuracy of this rifle right out of the box. I did not intend to spend this much money on a AR rifle, but this is a beautiful weapon that will provide me with many years of use and enjoyment.

Review by Sandman Posted on 2/25/22

### SUPERIOR CRAFTSMANSHIP

OVERALL ★★★★★

I couldn't be any happier with my mil spec + DDM4V7. Pulling it out of the box for the first time and seeing the quality of finish and knowing that every part of rifle went through a quality control inspection gives me piece of mind. And taking the first shots seeing how accurate it shoots and how incredible and feels in my hands is better than I ever expected. Thank you to the entire DD team. Keep up the amazing work...

Review by Naps22 Posted on 2/16/22

### UNBELIEVABLE QUALITY

OVERALL ★★★★★

This was such a clear decision to make when I went looking for an AR. The impeccable quality of their AR build is truly second to none....I've never had a second thought about my decision since I acquired the DDV4v7. There are many makes and models out there and while decisions are made for many reasons there was no regret on my part. -S

Review by Steve6 Posted on 2/9/22

### DDM4V7

9/25/23, 7:56 PM

Daniel Defense, M4, Carbine, V7, 5.56 | Daniel Defense

OVERALL ★★★★★

Review by Kylee Posted on 1/22/22

Well worth the wait and the price. I'm extremely pleased with my purchase. The build quality is superior, attention to detail, and the accuracy of this rifle is phenomenal. If your in the market for an AR-15 Daniel Defense will not disappoint.

ONE MY FIRST AR15 AND THE BED ONE

Review by Zaidy Posted on 12/23/21

OVERALL ★★★★★

Love the gun beautiful and reliable plus very best one looking forward to taking it to range and use it. Why I went to buy Daniel Defense DDM4 V7 because how it is build very perfectly.

PREMIUM RIFLE AND AMAZING QC

Review by Jack Posted on 5/14/21

OVERALL ★★★★★

I have a pretty decent experience with AR's, having put a thousand or few rounds through a handful of different AR's, so when I talked to a few of my friends and asked them what manufacturers they would suggest, all four of them were very adamant about Daniel Defense. I ended up purchasing a DDM4V7 and when I got home, I extensively looked over the finish of the gun and I have to say I am very impressed. None of the other firearms I have purchased have ever looked this flawless (finish wise) when I purchased them. I looked pretty hard to find even the smallest and hard to see scratches or marks and still couldn't find anything. I can really tell when I pick it up that employees at DD really care about QC and it just feels, looks and shoots like a premium rifle. I have only put about a thousand rounds through the gun, but I have had zero issues, and it shoots like a dream. I doubt whoever worked on my rifle will see this, but a huge thanks to RD who built the upper, ER who built the lower, and DB who was the QA inspector. Very impressed!

QUALITY

Review by J USA Posted on 5/5/21

OVERALL ★★★★★

Order my DDM4 V7 and received it within the week. GREAT firearm! Did non-stop research, over the hundreds of manufactures. Being prior military I have a certain feel that I was looking for, and DD nailed it! ALSO, customer service is OUTSTANDING! Seriously, they helped me receive my Military Discount and responded to my correspondences within 24 hours. Hands down the best experience I've had thus far purchasing a firearm!

DEDNUTZ AND LIGHT. WHAT'S NOT TO LIKE?

Review by Mickey Posted on 5/1/21

OVERALL ★★★★★

Have had to shoot at an indoor, 25yd max situation with iron sights and scope during the C-19 months. Moved to a Giessele SDC trigger early and the results were boringly superior both supported and freehand in any stance. Today had the opportunity to scope it on 100yds with a 10mph crosswind and, after minor windage/elevation adjustments could place overlapping shots. This was using cheap range .223 and some 62gr 5.56 for comparison. The DDMV7 barrel and smooth operation only leaves room for your excuses when you don't hit the mark and Well worth the price.

DDM4V7

Review by Darius Posted on 4/28/21

OVERALL ★★★★★

I final traded n my sig 556xi for this beautiful rifle. The thing is a beast

MY DREAM AR...

Review by CHRIST VET Posted on 4/17/21

OVERALL ★★★★★

I don't have alot to add to all the other 5star reviews,without a doubt the best AR I have ever held or shot...EVERYTHING I EXPECTED AND MORE!! You'll not find a better rifle...PERIOD!!



9/25/23, 7:56 PM

Daniel Defense, M4, Carbine, V7, 5.56 | Daniel Defense

YOU'RE REVIEWING:

**DDM4®V7®**

YOUR RATING • ★ ★ ★ ★ ★

NICKNAME •

SUMMARY •

REVIEW •

**SUBMIT REVIEW**

This site is protected by reCAPTCHA and the Google [Privacy Policy](#) and [Terms of Service](#) apply.

**STAY UP TO DATE**

**ENTER YOUR EMAIL**



This site is protected by reCAPTCHA and the Google [Privacy Policy](#) and [Terms of Service](#) apply.

**FOLLOW US**

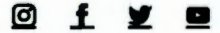

# Exhibit A-9

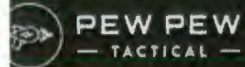

### HOW TO UPGRADE YOUR AR-15

We've built dozens of AR's and we'll cover all the best AR-15 upgrades such as handguards, triggers, BCGs, gas blocks, and more.

#### AR 15

- Beginner's Guide to Guns
- Concealed Carry
- Ammo & Reloading
- Gunsmithing
- Gun Laws by State
- Concealed Carry Laws
- Survival
- Women

SEE ALL GUIDES

#### MOST POPULAR

- How to Upgrade Your AR-15
- How to Upgrade Your Glock
- How to Assemble an AR-15 Upper
- How to Assemble an AR-15 Lower
- How to Reload Ammo
- How to Choose a Holster
- How to Choose a CCW Handgun
- How to Upgrade Your Ruger

SEE ALL GUIDES



Want Free Practice Targets? Get our 9 favorite targets and drills

## [How-To] Survive a Tornado: Tips to

ps://www.pewpewtactical.com/#

TRIES AD



Best Hammer-Fired Pistols SEP 21 2023 VIEW MORE

#### Most Popular



5 Best Home-Defense Shotguns of 2023: Tactical, Pump & Semi-Auto



9 Best Concealed Carry Guns in 2023: 9mm, .45 ACP, & More



MILITARY-GRADE CBRN PROTECTION NOW AVAILABLE FOR CIVILIANS MIRA SHOP NOW

AR-15 Rifles [The Definitive Resource]

## AR-15 Rifles [The Definitive Resource]



The AR-15 is America's most popular sporting rifle. And because of that, there's dozens of reputable manufacturers, tons of options, and thousands of accessories.

Whether you're looking for the perfect AR-15 as a first-time buyer or just the perfect upgrades and optics...you're in the right place.

### The Modern AR-15

It used to be really easy...head down to your local gun shop and choose from the 2 or 3 AR's they had on the shelf. But those days are long gone.

Now you're bombarded with **TOO** many choices...

But if you do your homework (with us), you'll be rewarded with the perfect AR 15 to fit your budget, purpose, and look.

Want Free Practice Targets?

JUMP TO SECTION

### SUMMARY OF OUR TOP PICKS



**HIGH-END PICK**  
**Daniel Defense DDM4 V7**

Our favorite high-end AR-15 that's built like a tank and battle proven.

\$1907 at Daniel Defense

[Jump to Details](#)



**ENTRY LEVEL PICK**  
**Palmetto State Armory (PSA) Complete AR-15s**

Most affordable AR-15 that goes boom when needed.

\$499 at PSA

[Jump to Details](#)



**ALSO GREAT HIGH-END PICK**  
**BCM Recce-15 MCMR AR-15**

Save a little from the DD and go with a BCM, but seldom in stock.

\$2599 at Brownells

[Jump to Details](#)



**CLASSIC PICK**  
**FN 15 Patrol Carbine**

Nicely made with quadrail, FSB and mil-spec furniture.

\$1299 at Palmetto State Armory

[Jump to Details](#)



**BUDGET PICK**  
**Smith & Wesson M&P15 Sport II 5.56 NATO**

What you'll find in most gun stores and sells like hotcakes.

\$640 at GrabAGun

[Jump to Details](#)



**LAW ENFORCEMENT PICK**  
**Colt LE6920 AR-15**

From Colt...enough said.

\$1099 at Palmetto State Armory

[Jump to Details](#)



**[How To] Clean and Lube an AR-15!**  
[SUBSCRIBE](#)

**Deals of the Day:**  
Hand-Picked Ammo & Firearm Discounts



**TIPPMANN ARMS AR FLIP UP SIGHTS - \$28.99**

SLP 25 2023 [SEE ALL DEALS](#)

Want Free Practice Targets?

Type here to search

# Exhibit A-10



AR-15 Parts, Bulk Ammo, Guns. x +



palmettostatearmory.com



Log In



Help Center



View Cart

PSA

AMMO

AR-15

AR-10

AK-47

GUNS

GUN PARTS

OPTICS

ACCESSORIES

BRANDS

DAILY DEALS



norton  
SHOPPING GUARANTEE  
9/26/2023

Type here to search



64°F Heavy rain 8:55 AM 9/26/2023

DEPOSITION EXHIBIT  
PENCILLI-Kaynes, B. J.



Log In Help Center View Cart

PSA AMMO AR 15 AR 10 AK 47 GUNS GUN PARTS OPTICS ACCESSORIES BRANDS DAILY DEALS



100 Series PSAK-7 GF3 PSAK-47 GF4 PSAK-47 GF5



Type 56 AK-V AK 5.56 AK Parts

DAILY DEALS

SHOP NOW

ALSO IN AK-47:

- AK-74
- AK-104
- AK R Rifles & Pistols
- Furniture & Hardware
- Builders Parts
- AK-105
- AK-103
- Magazines
- Braces
- Builders Kits
- AK-P
- AK-E
- Muzzle Devices
- Mounts
- ComBloc Kit Guns

Shop all AK-47 Products >

**YOUR WAY** 011 111 111 111 **STZ** **CALIBER**

Visit The Official PSA Forum and Join The Conversation

Trending Categories:



Type here to search





Shop AK-47 Rifles, Parts & Accs x +

palmettostatearmory.com/ak-47.html



Log In

Help Center

View Cart

PSA

AMMO

AR-15

AR-10

AK-47

GUNS

GUN PARTS

OPTICS

ACCESSORIES

BRANDS

DAILY DEALS

HOME / AK-47

# AK-47 RIFLES, PISTOLS, PARTS & MUCH MORE

Palmetto State Armory is your online AK-47 headquarters. Whether you are looking for a complete AK-47 rifle/pistol or AK parts, we have it all and from the top brands you know and trust. Everyone deserves to have this iconic gun in their collection.



PSAK-47 GF3



PSAK-47 GF4



PSAK-47 GF5



100 Series



AKV



Type 56



WBP Kit Builds



Parts



Type here to search







Log In

Help Center

View Cart

PSA

AMMO

AR-15

AR-10

AK-47

GUNS

GUN PARTS

OPTICS

ACCESSORIES

BRANDS

DAILY DEALS

HOME / AK-47 / AK-P

# AK-P

Feast your eyes on Palmetto State Armory's AK-P, the new standard in AK-47 pistols. To manufacture an excellent AK pistol, PSA engineers had to design, build and test with excellence in mind and they have achieved just that. To ensure the longevity that AK-47s are known for, the AK-P was built with a hammer-forged front trunnion, bolt, and carrier along with a 4150 steel barrel with a gas nitride finish. The AK-P is a must-have firearm that will provide an excellent shooting experience. See our [AK-P GF3](#) and [GF4](#) AK-47 Pistols.



GF3



GF4



Parts & Accessories



Type here to search

# Exhibit A-11

9/26/23, 3:30 PM

PSAK-47 GF5 Forged Classic Rifle, Redwood | Palmetto State Armory



DAILY DEALS

HOME / AK-47 / PSAK-47 GF SERIES / PSAK-47 GF5 / PSAK-47 CLASSIC RIFLES / PSAK-47 GF5 FORGED CLASSIC RIFLE, REDWOOD

IN STOCK

## PSAK-47 GF5 FORGED CLASSIC RIFLE, REDWOOD

IN STOCK

# PSAK-47 GF5 FORGED CLASSIC RIFLE, REDWOOD

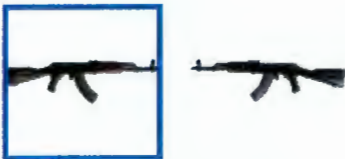

\$1,029.99

- 1 +

ADD TO CART

**PRODUCT MANUAL**

Handling firearms or firearms parts can expose you to lead and other petroleum products known to the State of California to cause cancer, birth defects, or other reproductive harm. Wash hands thoroughly after handling. For more information go to [www.p65warnings.ca.gov](http://www.p65warnings.ca.gov) (CA Health and Safety Code Section 25249.6).

Customers must read Compliance Information before purchasing.

SKU 5655104080

Model Number 5655104080



Palmetto State Armory





9/26/23, 3:30 PM

PSAK-47 GF5 Forged Classic Rifle, Redwood | Palmetto State Armory

UPC 5655104080

**DAILY DEALS**

[Add to Compare](#) Share: [✉](#) [f](#) [t](#)

[Purchase](#) [Norton](#) [SHOPPING GUARANTEE](#) [Learn more](#)

### CUSTOMER GALLERY



## PRODUCT DETAILS

### DETAILS

- FN Cold Hammer Forged Chrome Moly Vanadium Steel Barrel; Chrome Lined
- Stamped Steel Receiver
- Blended Hammer Forged 4340 Aircraft Quality Front Trunnion
- Hammer Forged Bolt
- Hammer Forged Carrier
- Side Scope Mount
- Enhanced Extended Safety Lever
- 7.62x39 Caliber
- 1 in 9.5" Twist
- Thread Pitch: M14x1LH
- Std. 800-yard rear sight leaf

[Wood Furniture](#)

9/26/2023



9/26/23, 3:30 PM

PSAK-47 GF5 Forged Classic Rifle, Redwood | Palmetto State Armory

ALG AKT Enhanced Trigger With Lightning Bow



30 round magazine (1); Where allowed by law

**DAILY DEALS**

The PSA GF5 AK-47 was designed from the ground up to create a new standard in AK-47 rifles, utilizing all new enhanced precision manufactured parts. Thoroughly tested in development, we tortured tested to 10,000 rounds to ensure a quality product. Not to be satisfied with just a good AK-47, we kept improving and now are proud to announce our PSAK-47 Gen5 Hammer Forged (GF5) rifle with a hammer-forged barrel, bolt, carrier, and front trunnion.

The barrel is a proprietary blend of hammer-forged chrome-moly vanadium made by FN that is referred to as "Machine Gun Steel" by virtue of its use in FN's M249 and M240 weapons. The hammer forging process work hardens the steel, making it more durable. This 16" barrel is magnetic particle inspected, to ensure quality and dependability and is pressed into a hammer forged 4340 AQ front trunnion to ensure the longevity AK-47's are known for. The hardened steel 1mm receiver features an ALG AKT Enhanced Trigger with Lightning Bow, and side rail mount. The front trunnion and bolt carrier are engraved with GF5 to designate the new GF5 hammer-forged model. The rifle is finished with a classic red wood handguard, stock, and grip. This rifle ships with 30 round magazine (where allowed by law).

Rifles must be shipped to a valid, current Federal Firearms Licensee (FFL). Please have the shipping address of your preferred FFL before placing your order. You will need the FFL information to complete the order. It is the purchaser's responsibility to be aware of the laws in their state regarding high capacity sporting rifles.

- As we are transitioning to Soviet Arms, your receivers may be stamped with our new AK Soviet Arms logo on firearms manufactured after 3/8/2023. This will not affect the quality or function of the firearm as they are the same AK receivers used for our AK's. This will only be a minor cosmetic change moving towards our Soviet Arms AK's.

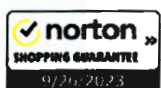



9/26/23, 3:30 PM

PSAK-47 GF5 Forged Classic Rifle, Redwood | Palmetto State Armory



**DAILY DEALS**



Not to be satisfied with just a good AK-47, we kept improving and now are proud to announce our PSAK-47 Gen5 Hammer Forged (GF5) rifle with a hammer-forged barrel, bolt, carrier, and front trunnion.



**FN Hammer Forged Chrome-moly Vanadium Barrel**

The GF5 features an upgraded barrel that is referred to as "Machine Gun Steel" due to its use in FN's M249 and M240 platform.



**ALG AKT Enhanced Trigger**

Upgraded trigger for a smooth and crisp pull.





9/26/23, 3:30 PM

PSAK-47 GF5 Forged Classic Rifle, Redwood | Palmetto State Armory



### Gas Block and Cleaning Rod

45 Degree Gas block with additional cleaning rod.



### Sling Mount

Traditional AK sling mount whether mounting a com bloc-style sling or modern sling.



### Front Sight Base



front sight base with cleaning rod lock up point with ant brake.

<https://palmettostatearmory.com/psak-47-gf5-forged-chf-classic-alg-red-wood-rifle.html>



### Side Mount

Traditional side rail for an optic mount - Midwest, RS Regulate recommended. Side rails vary GREATLY between countries, so mounts can be finicky due to large tolerances, which is why we recommend certain mounts.



### Spring and Bolt

Piston operated system with recoil assembly. Hammer Forged Carrier, Bolt and Trunnion. This is the heart of the gun where wear happens. We are one of the few companies that does it correctly and has emulated com-bloc guns with Hammer Forged bolt, carrier and trunnion, and gone even further with our AQ4340 trunnion for even more durability.



### Sight Leaf

Standard 800-yard rear sight leaf.



9/26/23, 3:30 PM

PSAK-47 GF5 Forged Classic Rifle, Redwood | Palmetto State Armory



DAILY DEALS

Search reviews...



Sort by: Most Recent

May 1, 2023



Red wood AK 47 GF5.



Fast shipping.....Str8 out of Box 300+ rounds , no issues.. pretty accurate. Smooth awesome wood finished. You,re gonna love ALG AKT Enhanced Trigger.... FAST .. 4 A little more \$ ,,,WORTH the upgrade from Gf3.... gREAT Job PSA. would of given 5 stars if it came with 2 mags ....

Show details

Mar 21, 2023



Solid rifle, minor cosmetic flaws.



Solid rifle, excellent trigger, furniture is mostly gorgeous. Finish is mostly excellent. Shoots great. Headspaced correctly.

Issues I have are the flathead screws that hold on the grip and the stock are stripped by the factory. Kinda ugly on an otherwise beautiful rifle. The front hand... [Read More](#)

Show details

Feb 26, 2023



This gun is beautiful and shoots well out of the box.

Show details



9/26/23, 3:30 PM

PSAK-47 GF5 Forged Classic Rifle, Redwood | Palmetto State Armory

Appears to operate at a acceptable level

**DAILY DEALS**



Oct 14, 2022



Love this gun



Really build well and works great so far, only put a few hundred rounds through it so far but no problem at all.

Show details

Aug 18, 2022



Another PSA winner!



My first AK, and it is a beauty! I have a number of plastic and wood furnished firearms, but I just love a nice wood grain. Very solid, fit and finish is tip top. Off to the range today, first three shot group off the bench at 50 yards was ~ 1 1/8" group about 7" high. Two front sight post...

[Read More](#)

Show details

BACK    NEXT >

**QUESTIONS & ANSWERS**



Search input field with a magnifying glass icon

Sort by: Most Common

**QUESTION:**

Can this be offered in a 12.5 barrel pistol format with a triangle folding brace please?

About [PSAK-47 GF5 Forged CHF Classic ALG Rifle, Black](#)

Asked by Jorge R on Jan 9, 2021

Was this question helpful? Yes (42)

**Answer**

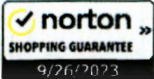



9/26/23, 3:30 PM

PSAK-47 GF5 Forged Classic Rifle, Redwood | Palmetto State Armory

QUESTION:



DAILY DEALS

BEST ANSWER:

Tree wood. It's the best type of wood.

Posted by Ryan B on Sep 14, 2022 purchased Jan 10, 2021 [Reply](#) [Inaccurate](#) ...

Was this question helpful? Yes (6)

[See 2 answers](#) [Answer](#)

QUESTION:

Can you add a featureless grip for us in California for this model?

Asked by Richard E on Aug 20, 2021

BEST ANSWER

The questions here aren't checked by PSA and are only answered by customers.

Posted by Brian P. on Dec 13, 2022 [Reply](#) [Inaccurate](#) ...

Was this question helpful? Yes (6)

[Answer](#)

QUESTION:

4th PSAK I've purchased and all came with mags. Any reason this GF5 did not?

Asked by A shopper on Feb 9, 2021

BEST ANSWER

My GF5 came with a 30 round PMAG. Do you live in a magazine capacity restricted state? That might be why

Posted by Mohibullah S. on Mar 4, 2021 purchased Feb 3, 2021 [Reply](#) [Inaccurate](#) ...

Was this question helpful? Yes (4)

[See 2 answers](#) [Answer](#)

QUESTION:

What magazines have you tested with this? Can I use surplus or just Magpul?

Asked by Mark F on Jan 11, 2021

BEST ANSWER

Most quality steel and polymer magazines will work with our AK's. Some may require minor fitment as they were made in various com-bloc countries.

Best Regards,  
PSA Customer Service.

Posted by Josiah M. **STAFF** on Jan 12, 2021 [Reply](#) [Inaccurate](#) ...

Was this question helpful? Yes (2)

[Answer](#)



9/26/23, 3:30 PM

PSAK-47 GF5 Forged Classic Rifle, Redwood | Palmetto State Armory

QUESTION:



When available again?

**DAILY DEALS**

24, 2021

**BEST ANSWER:**

typically every week day.. check at 4pm EST

Posted by Corey F. on Mar 26, 2021 purchased Jan 7, 2021 [Reply](#) [Inaccurate](#) ...

Was this question helpful? **Yes (1)**

[Answer](#)

[BACK](#)

[NEXT >](#)

## RETAIL STOCK

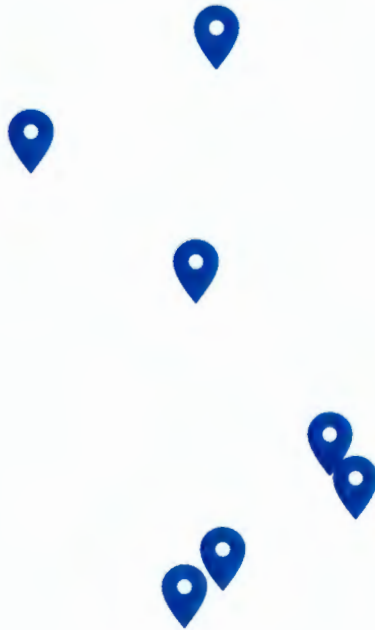

 Please note that stock-status may differ from what is represented below.  
Please call to verify actual stock-status before arriving to store.  
Please read all our [Terms & Conditions for Retail Firearm Transfers](#).

## VISIT US IN STORE



9/26/23, 3:30 PM

PSAK-47 GF5 Forged Classic Rifle, Redwood | Palmetto State Armory

**OUT OF STOCK**



& Range  
Rd  
Ridgeland, SC 29936  
(843) 379-4867

**MORE INFO**

**OUT OF STOCK**

Columbia - Store & Range  
3760 Fernandina Rd  
Columbia, SC 29210  
(803) 551-2680

**MORE INFO**

**OUT OF STOCK**  
**DAILY DEALS**

Greenville - Store & Range  
1040-A Woodruff Rd  
Greenville, SC 29607  
(864) 605-6680

**MORE INFO**

**OUT OF STOCK**

Summerville - Store & Ran...  
366 E. 5th North Street  
Summerville, SC 29483  
(843) 900-9000

**MORE INFO**

## COMPLIANCE

### Shipping Restrictions

It is the customer's responsibility for understanding state laws regarding all purchases made. For a comprehensive list of all Shipping Restrictions, please refer to our Shipping Restrictions By State Page found [Here](#).

### All NFA Rules Apply

These items are controlled by the U.S. Government and authorized for export only to the country of ultimate destination for use by the ultimate consignee or end-user(s) herein identified. They may not be resold, transferred, or otherwise disposed of, to any other country or to any person other than the authorized ultimate consignee or end-user(s), either in their original form or after being incorporated into other items, without first obtaining approval from the U.S. government or as otherwise authorized by U.S. law and regulations.

Magazines will be removed from firearms when shipping to states with magazine capacity restrictions.

Handling firearms or firearms parts can expose you to lead and other petroleum products known to the State of California to cause cancer, birth defects, or other reproductive harm. Wash hands thoroughly after handling. For more information go to [www.p65warnings.ca.gov](http://www.p65warnings.ca.gov) (CA Health and Safety Code Section 25249.6).

## WARRANTY





9/26/23, 3:30 PM

PSAK-47 GF5 Forged Classic Rifle, Redwood | Palmetto State Armory



# AMERICAN MADE. FOR LIFE.



## FULL LIFETIME WARRANTY.

Palmetto State Armory firearms are covered by an industry leading **FULL LIFETIME WARRANTY**. This extends beyond the original purchaser. We want the person who bought a great quality firearm at an excellent price to have comfort in knowing that no matter what, the firearm can be fixed at no additional cost.

THIS INCLUDES SHIPPING BOTH WAYS.

We strive for excellence all the way through production and hope customers never *have* to use this warranty but we also pride ourselves in 99% non-repair/return ratio. It is there for peace of mind so that the consumer can be confident in their purchase. Should the consumer ever need to contact us regarding a repair under the warranty, simply use our [contact form](#) or give us a call at [877-560-7229](tel:877-560-7229).

Palmetto State Armory firearms and parts are backed by our Full Lifetime Warranty. Our PSA firearms and parts are warranted to be free from defects in materials and craftsmanship for the serviceable lifetime of the firearm or part. All Palmetto State Armory barrels are machined and guaranteed to be corcentric with the bore of our barrels.

### For the Life of our product

The liability of Palmetto State Armory under this warranty shall be limited solely to the obligation to repair or replace the firearm/part or defect at its discretion, and to pay transportation and insurance charges for return of the firearm to the owner for a rightful warranty claim. This warranty is transferable for the serviceable lifetime of the firearm or part. Modification of firearm will void this warranty. This warranty does not cover normal wear or any damage resulting from careless handling, neglect, repairs and adjustments, corrosion, improper, substandard or defective ammunition.

### What we don't cover

Under no circumstances shall Palmetto State Armory be responsible for incidental or consequential damages with respect to economic loss or injury to property, whether as a result of express or implied warranty, negligence or otherwise. Some states do not allow the exclusion or limitation of incidental or consequential damages, so the above limitation may not apply to you. Palmetto State Armory will



9/26/23, 3:30 PM

PSAK-47 GF5 Forged Classic Rifle, Redwood | Palmetto State Armory



not be responsible for the results of careless handling, unauthorized adjustments, defective, low-quality, reloaded, or improper ammunition, corrosion, neglect, ordinary wear and tear, or unreasonable use.

### Initiating a claim

To initiate a Warranty claim, call Palmetto State Armory Customer Service:

**Hours:** Monday through Friday, 9am - 5pm EST

**Email:** [Contact Form](#)

1. Customer service will issue an RMA number to allow for the return of the firearm.
2. Warranty claims must have this RMA filled out, and included in the box with the firearm or part.
3. The firearm or part concerned must be shipped using the prepaid label our representative emails to you.

Palmetto State Armory will pay shipping and insurance charges for the return of a firearm or part to its owner or FFL, if the related claim is a proper claim for warranty work. If Palmetto State Armory is unable to fix the original serial number, a new one will be sent out, but must go to an FFL for transfer back to the customer. Another background check will be completed at the time of transfer. Palmetto State Armory is not responsible for transfer fees at the FFL.

**DOWNLOAD REPAIR REQUEST FORM**



### AMENDMENT II

*A well regulated Militia, being necessary to the security of a free State, the right of the people to keep and bear Arms, shall not be infringed.*



9/26/23, 3:30 PM

PSAK-47 GF5 Forged Classic Rifle, Redwood | Palmetto State Armory



**DAILY DEALS**

Questions? Need help? Call us: [\(877\) 560-7229](tel:(877)560-7229)



About SSL Certificates



**COMPANY**

**INFO**

**LEGAL**

**CONTACT INFORMATION**

[Blog](#)

[Check Shipping Status](#)

[Terms & Conditions](#)

Palmetto State Armory  
3760 Fernandina Rd.  
Columbia, SC 29210

[Careers](#)

[My Account](#)

[Retail Return Policy](#)

[About PSA](#)

[Contact Us](#)

[Full Lifetime Warranty](#)

[Affiliate Program](#)

[Rebates & Promotions](#)

[Shipping Restrictions](#)

**HELP CENTER**

[Retail Stores](#)

[Compare Products](#)

[Privacy Policy](#)

[Defense Courses](#)

[Check Order Status](#)

[Sitemap](#)

[SC CWP Info](#)

[Gift Card Balance](#)

[Shoot Responsibly](#)[FAQ](#)

[Forum](#)

[Buying a Gun Online](#)

[The Gathering](#)

[FFL Locator](#)

[Product Manuals](#)

[California Buying Guide](#)

© 2023 PALMETTO STATE ARMORY. ALL RIGHTS RESERVED.





9/26/23, 3:30 PM

PSAK-47 GF5 Forged Classic Rifle, Redwood | Palmetto State Armory

# Group Exhibit B

<p style="text-align: center;">IN THE UNITED STATES DISTRICT COURT FOR THE SOUTHERN DISTRICT OF ILLINOIS</p> <p>CALEB BARNETT, et al., ) Plaintiffs, ) vs. ) KWAME RAOUL, et al., ) Defendants. )</p> <hr/> <p>DANE HARREL, et al., ) Plaintiffs, ) vs. ) KWAME RAOUL, et al., ) Defendants. )</p> <hr/> <p>JEREMY W. LANGLEY, et al., ) Plaintiffs, ) vs. ) KWAME RAOUL, et al., ) Defendants. )</p> <hr/> <p>FEDERAL FIREARMS LICENSEES OF ) ILLINOIS, et al., ) Plaintiffs, ) vs. ) JAY ROBERT "JB" PRITZKER, et al., ) Defendants. )</p> <p style="text-align: center;">VIDEOTAPED DEPOSITION OF SCOTT PULASKI Taken on behalf of the Defendants October 3rd, 2023 2:06 p.m. to 6:04 p.m. Jamie Jo Kinder, CCR 842, CSR 084.003306</p>	Page 1	<p>1 Deposition Exhibit 17 115</p> <p>2 (Exhibits retained by the Reporter and attached.)</p> <p>3 (Exhibit 15 was marked and attached, but was not</p> <p>4 introduced on the record.)</p> <p>5 (The material quoted in the transcript was written verbatim</p> <p>6 as read, and may not be a direct quote from the exhibit.)</p> <p>7</p> <p>8</p> <p>9</p> <p>10</p> <p>11</p> <p>12</p> <p>13</p> <p>14</p> <p>15</p> <p>16</p> <p>17</p> <p>18</p> <p>19</p> <p>20</p> <p>21</p> <p>22</p> <p>23</p> <p>24</p> <p>25</p>	Page 3
<p style="text-align: center;">I N D E X</p> <p style="text-align: right;">Page</p> <p style="text-align: center;">EXAMINATION</p> <p>4 QUESTIONS BY MR. WELLS 7</p> <p>5 QUESTIONS BY MR. MAAG 124</p> <p>6 QUESTIONS BY MR. WELLS 157</p> <p>7</p> <p>8</p> <p>9</p> <p style="text-align: center;">EXHIBITS</p> <p>11 Deposition Exhibit 1 28</p> <p>12 Deposition Exhibit 2 29</p> <p>13 Deposition Exhibit 3 42</p> <p>14 Deposition Exhibit 4 43</p> <p>15 Deposition Exhibit 5 49</p> <p>16 Deposition Exhibit 6 53</p> <p>17 Deposition Exhibit 7 55</p> <p>18 Deposition Exhibit 8 59</p> <p>19 Deposition Exhibit 9 66</p> <p>20 Deposition Exhibit 10 69</p> <p>21 Deposition Exhibit 11 77</p> <p>22 Deposition Exhibit 12 82</p> <p>23 Deposition Exhibit 13 99</p> <p>24 Deposition Exhibit 14 104</p> <p>25 Deposition Exhibit 16 112</p>	Page 2	<p style="text-align: center;">IN THE UNITED STATES DISTRICT COURT FOR THE SOUTHERN DISTRICT OF ILLINOIS</p> <p>CALEB BARNETT, et al., ) Plaintiffs, ) vs. ) KWAME RAOUL, et al., ) Defendants. )</p> <p>-----) and all related cases. )</p> <p style="text-align: center;">VIDEOTAPED DEPOSITION OF WITNESS, SCOTT PULASKI, produced, sworn, and examined on the 3rd day of October, 2023, between the hours of 8:00 o'clock in the forenoon and 5:00 o'clock in the afternoon of that day, at the Office of the Illinois Attorney General, 201 West Pointe Drive, Suite 7, Swansea, IL, before Jamie Jo Kinder, Missouri CCR 842, Illinois CSR 084-003306, a Certified Shorthand Reporter within and for the State of Illinois, in a certain cause now pending in the United States District Court for the Southern District of Illinois.</p>	Page 4



A P P E A R A N C E S

1 For the Plaintiffs Langley, et al.:

2 Mr. Thomas G. Maag

3 MAAG LAW FIRM, LLC

4 22 W. Lorena Avenue

5 Wood River, IL 62095

6 (618) 216-5291

7 tmaag@maaglaw.com

8

9 For the Defendants Raoul and Kelly:

10 Mr. Christopher G. Wells

11 Ms. Gretchen Helfrich

12 OFFICE OF THE ATTORNEY GENERAL

13 100 W. Randolph Street

14 Chicago, IL 60601

15 (312) 814-3000

16 christopher.wells@ilag.gov

17

18 For Cole Shaner:

19 Mr. Keith Hill (via Zoom)

20 HEYL ROYSTER VOELKER & ALLEN

21 103 W. Vandalia Street, Suite 100

22 Edwardsville, IL 62025-0467

23 (618) 656-4646

24 khill@heylroyster.com

25

18 Also present via Zoom: Mr. John Zimmerman and

19 Ms. Abby Sgro,

20 in-house counsel for ISP

21 Ms. Jamie Jo Kinder, CCR, CSR

22 Mr. Ken Carden, Videographer

23 LEXITAS LEGAL

24 711 N. Eleventh Street

25 St. Louis, MO 63101

(800) 280-3376

https://lexitaslegal.com

stl.customerservice@lexitaslegal.com

1 State defendants.

2 THE VIDEOGRAPHER: Would the court reporter

3 please swear in the witness.

4 (Witness sworn in.)

5 MR. WELLS: I'll just make the note again,

6 that this is specifically in the Langley versus Kelly case,

7 which is Case No. 3:23-cv-192-SPM, also in the Southern

8 District of Illinois.

9 As I noted in the prior deposition, we're

10 taking this deposition in light of the Langley plaintiffs

11 having filed a motion for summary judgment on their two

12 vagueness claims. The State defendants reserve their

13 rights to seek additional discovery and potentially to take

14 additional depositions, including a second deposition of

15 this witness, related to other claims that have been

16 asserted in Langley and Barnett and the consolidated

17 actions there. So just make that note for the record.

18 With that reservation of rights, we're going

19 to proceed with this deposition.

20 \*\*\*\*\*

21 SCOTT PULASKI,

22 of lawful age, being produced, sworn and examined on

23 behalf of the Defendants, deposes and says:

24 EXAMINATION

25 QUESTIONS BY MR. WELLS:

1 (Deposition commenced at 2:06 p.m.)

2 IT IS HEREBY STIPULATED AND AGREED, by and

3 between counsel for Plaintiffs and counsel for Defendants,

4 that the videotaped deposition of SCOTT PULASKI may be taken

5 in shorthand by Jamie Jo Kinder, CCR, CSR, a notary public

6 and shorthand reporter, and afterwards transcribed into

7 typewriting; and the signature of the witness is expressly

8 waived.

9 \*\*\*\*\*

10 THE VIDEOGRAPHER: We are on the record.

11 Today's date is October 3rd, 2023. The time now is 2:06.

12 This is the video-recorded deposition of Scott Pulaski in

13 the matter of Caleb Barnett, et al., v Kwame Raoul, et al.,

14 Case No. 3:23-cv-192-SPM in the United States District

15 Court for the Southern District of Illinois.

16 This deposition is being held at 201 West

17 Pointe Drive. The reporter's name is Jamie Kinder. My

18 name is Ken Carden. I'm the legal videographer.

19 Would the attorneys present please introduce

20 themselves and the parties they represent.

21 MR. WELLS: Sure. This is Christopher Wells

22 on behalf of the State defendants.

23 MR. MAAG: Thomas Maag, M-A-A-G, on the

24 Langley plaintiffs.

25 MS. HELFRICH: Gretchen Helfrich on behalf of

1 Q Have you ever been deposed before,

2 Mr. Pulaski?

3 A I have not.

4 Q So I'm going to go through a couple of ground

5 rules.

6 A Sure.

7 Q Just to help this go as smoothly as possible.

8 You're under oath.

9 A Uh-huh (yes).

10 Q Just as if we were in court. There's a court

11 reporter who's here taking down everything that everybody

12 says as best she can. And in order to help her out, I'd

13 ask a couple of things. One, if you could wait for me to

14 finish a question before you start to answer. It's very

15 hard to do, and you will fail at it, but I'll try to remind

16 you as we go along to -- to wait for me to finish. Okay?

17 A Okay.

18 Q And I will also do the same. I will try to

19 wait for you to finish before interrupting you so that the

20 record can be clear. Is that fair?

21 A Yes.

22 Q If I ask you a question and you answer, I'm

23 going to assume you understood the question. If you don't

24 understand my question, then you can ask me to clarify.

25 A Okay.

Page 9

1 Q Mr. Maag may object from time to time.  
 2 Generally speaking, if he objects, you still have to answer  
 3 the question unless he specifically instructs you not to.  
 4 There are a couple reasons why he might do that. If those  
 5 come up, we'll deal with them. But generally speaking,  
 6 even if he objects, you can still answer, if you  
 7 understand. Fair enough?  
 8 **A Okay.**  
 9 Q If you need a break at any time, let me know.  
 10 If you need a water, if you need to go to the restroom,  
 11 it's not a problem. The only thing I'd ask is that if  
 12 there's a question pending, I'd ask you to finish answering  
 13 that question before we take a break.  
 14 **A Certainly.**  
 15 Q And just to be clear in terms of timing, so we  
 16 started at 2:00 o'clock. I am hoping we can be out of here  
 17 by 6:00, but that is -- depends on how things go obviously.  
 18 Right?  
 19 **A Okay.**  
 20 Q Do you have any scheduled commitments that I  
 21 should be aware of as we go through this?  
 22 **A Just at 8:00 p.m.**  
 23 Q Okay.  
 24 MR. MAAG: If we're still here at 8:00 p.m.  
 25 Q (By Mr. Wells) Yeah. Well, understood.

Page 10

1 Mr. Pulaski, are you -- And I apologize for the probing  
 2 nature of this question, but are you on any medication  
 3 today that would affect your ability to answer -- testify  
 4 truthfully and completely?  
 5 **A I am not.**  
 6 Q Are you on any drugs or -- that would have a  
 7 similar effect and impact your ability?  
 8 **A No.**  
 9 Q Just like practice, so you just got to wait.  
 10 How about alcohol, are you on -- have you had  
 11 any alcohol today?  
 12 **A I have not.**  
 13 Q Okay. So as I mentioned, the reason we're  
 14 taking this deposition today is that the plaintiffs in the  
 15 Langley case have filed a motion for summary judgment on  
 16 two claims in that case. The Langley plaintiffs lawsuit  
 17 challenges the constitutionality of Illinois Public Act  
 18 102-1116. It's also known as the Protecting Illinois  
 19 Communities Act. We can shorten that to PICA. I'm going  
 20 to use PICA to refer to the statute that's being challenged  
 21 in the Langley case. Is that fair?  
 22 **A Yes.**  
 23 Q And if I say PICA, you understand I'm talking  
 24 about the Illinois statute that took effect on January 10,  
 25 2023, and regulates assault weapons and -- and that sort of

Page 11

1 thing?  
 2 **A I do.**  
 3 Q You are not a plaintiff in the Langley case;  
 4 correct?  
 5 **A Correct.**  
 6 Q What is your relationship to the Langley  
 7 lawsuit?  
 8 **A As an affidavit filer. Sorry. I don't know**  
 9 **the term for that. But was asked to prepare an affidavit**  
 10 **from Mr. Maag.**  
 11 Q When did he ask you to prepare that affidavit?  
 12 **A I do not remember the date for that.**  
 13 Q Does Mr. Maag represent you in this case?  
 14 **A In the Langley --**  
 15 Q This case --  
 16 **A In the Langley case, no.**  
 17 Q Does he represent you in any other capacity?  
 18 **A I believe we're in the early stages of another**  
 19 **case, yes.**  
 20 Q What is that other case?  
 21 **A I do not recall the name of that case.**  
 22 Q So Mr. Maag is your attorney in another  
 23 lawsuit that you filed against officials in the State of  
 24 Illinois; is that right?  
 25 **A Correct.**

Page 12

1 Q When Mr. Maag asked you to write an affidavit,  
 2 what -- what specifically were you asked to write an  
 3 affidavit about?  
 4 **A About the vagueness of the PICA and some of**  
 5 **the lack of clarity of things in there.**  
 6 Q And is Mr. Maag representing you today in this  
 7 deposition?  
 8 **A I don't understand. I'm sorry.**  
 9 Q No, I understand.  
 10 **A I'm new to depositions.**  
 11 Q Is he serving as your attorney for purposes of  
 12 this deposition today?  
 13 **A Not to my knowledge.**  
 14 MR. MAAG: As long as we're not touching on  
 15 the other case.  
 16 MR. WELLS: Which -- Oh, the other case that  
 17 he's filed?  
 18 MR. MAAG: Yes.  
 19 MR. WELLS: For which you are his attorney?  
 20 MR. MAAG: Correct.  
 21 Q (By Mr. Wells) Okay. So in the Langley case  
 22 today, are you testifying as an expert witness?  
 23 **A I've never been qualified as an expert**  
 24 **witness, but I have long experience in the field of**  
 25 **firearms.**

Page 13

1 Q So are you being put forward as an expert  
2 witness in this case?  
3 **A I would presume so.**  
4 MR. WELLS: Is he being put forward as an  
5 expert witness in this case under Rule 702?  
6 MR. MAAG: I'd have to reread the rule for the  
7 particularities. I think it's more of a fact witness,  
8 but --  
9 MR. WELLS: Okay. So your understanding is  
10 that Mr. Pulaski is serving as a fact witness?  
11 MR. MAAG: Yes.  
12 MR. WELLS: Can we go off the record for just  
13 one second? Sorry.  
14 THE VIDEOGRAPHER: This is the videographer.  
15 We're going off the record. Time now is 2:14.  
16 (Whereupon, a short break was taken.)  
17 THE VIDEOGRAPHER: This is the videographer.  
18 We're back on the record. The time now is 2:16.  
19 Q (By Mr. Wells) I just want to clarify. So are  
20 you a plaintiff, you personally, a plaintiff in any other  
21 case?  
22 **A I am a plaintiff in the -- I'm sorry. I can't**  
23 **recall the -- the named plaintiff, but we are -- Piasa**  
24 **Armory is a plaintiff in one of these cases, which is my**  
25 **company.**

Page 14

1 Q (By Mr. Wells) Your company is a plaintiff?  
2 **A Correct. I -- I am specifically not.**  
3 **However, my company is.**  
4 Q You, as an individual, are not?  
5 **A Correct.**  
6 MR. MAAG: As far as I know, him as an  
7 individual is not.  
8 MR. WELLS: Okay. And who -- Here's my issue  
9 is, I -- to the extent he's a represented party in the  
10 other case, he needs to have his attorney from the other  
11 case here. He said he's at the end --  
12 **THE WITNESS: Chuck Michel is our other**  
13 **attorney.**  
14 MR. WELLS: My understanding coming to this  
15 was that you would be representing him for purposes of this  
16 deposition; is that right?  
17 MR. MAAG: Do you want me to represent you for  
18 purposes of this deposition?  
19 **THE WITNESS: I am comfortable with that.**  
20 MR. MAAG: Then so be it.  
21 MS. HELFRICH: Okay.  
22 Q (By Mr. Wells) And again, to be clear, in the  
23 Piasa Armory case where -- not the one where Mr. Maag  
24 represents you, but the -- the challenge to PICA?  
25 **A Correct.**

Page 15

1 Q The named plaintiff there, the named party, is  
2 the business Piasa Armory; correct?  
3 **A Correct.**  
4 Q And you, the individual, Scott Pulaski, are  
5 not a named plaintiff in that case; is that right?  
6 **A To my knowledge.**  
7 MR. MAAG: As far as I know, that's correct.  
8 Q (By Mr. Wells) And when you say Mr. Michel,  
9 Mr. Michel represents Piasa Armory; is that --  
10 **A All of -- I'm sorry. All of the plaintiffs.**  
11 Q Right. But including Piasa Armory; is that  
12 right?  
13 **A Correct.**  
14 Q And he exclusively represents Piasa Armory.  
15 He does not represent Scott Pulaski because Scott Pulaski  
16 is not in -- a plaintiff in that case; correct?  
17 **A Correct.**  
18 Q And you have indicated that Mr. Maag -- you  
19 agree to Mr. Maag being your counsel for purposes of this  
20 deposition today?  
21 **A Yes.**  
22 Q Can you tell me about how you went about  
23 preparing your January 23rd, 2023, affidavit, for the  
24 Langley case?  
25 **A Yeah. This was with assistance from Mr. Maag.**

Page 16

1 **Basically working together to provide and clarify**  
2 **information that would be of assistance to these cases.**  
3 Q How long have you known Mr. Maag?  
4 **A Several years.**  
5 Q How do you know him?  
6 **A Through our business.**  
7 Q What's your business?  
8 **A Piasa Armory.**  
9 Q And how did you come to know Mr. Maag?  
10 **A Mr. Maag has been a customer of ours for**  
11 **several years.**  
12 Q And when you say customer of yours, what do  
13 you mean?  
14 **A Has bought and sold various items and services**  
15 **from us.**  
16 Q And are you aware that Mr. Maag has a -- has a  
17 firearms business?  
18 **A I am.**  
19 Q Does his firearms business ever buy firearms  
20 from Piasa Armory?  
21 **A I do not believe it has.**  
22 Q So when you say Mr. Maag is a customer,  
23 Mr. Maag, in his individual capacity, as a customer, is  
24 that your understanding?  
25 **A Correct.**



Page 17

1 Q When you prepared your January 23, '23 --  
 2 January 23, 2023, affidavit in this case, did you consult  
 3 any written materials in preparing that affidavit?  
 4 **A No, I did not.**  
 5 Q What did you rely on?  
 6 **A Knowledge and assistance from Mr. Maag.**  
 7 Q How did you prepare your May 18, 2023,  
 8 statement pursuant to 28 USC 1746 for the Langley case?  
 9 **A In a similar manner.**  
 10 Q Are you being -- Or were you compensated for  
 11 preparing either of those affidavits?  
 12 **A No.**  
 13 Q Are you being paid for your testimony today?  
 14 **A I am not.**  
 15 Q In the lawsuit -- Let's see.  
 16 In the lawsuit in which you are -- in which  
 17 Piasa Armory is a named plaintiff, why did -- what's your  
 18 understanding as to why Piasa Armory brought that lawsuit?  
 19 **A To have the PICA ruled unconstitutional.**  
 20 Q What claims did Piasa Armory bring in that  
 21 lawsuit?  
 22 **A I did not write that or -- I'm not -- I don't**  
 23 **recall the specifics of that claim. But basically, that it**  
 24 **was a Second Amendment violation and inconsistent with the**  
 25 **ruling -- excuse me -- the ruling from the Supreme Court.**

Page 18

1 Q Did Piasa Armory, in that lawsuit, Federal  
 2 Firearms Licensee of Illinois versus Pritzker, No.  
 3 23-cv-215-SPM, assert that PICA was unconstitutionally  
 4 vague?  
 5 **A I -- I did not make that filing. I don't**  
 6 **recall if that was in that.**  
 7 Q What financial impact has PICA had on your  
 8 business at Piasa Armory?  
 9 **A We estimate approximately 50 percent loss of**  
 10 **revenue.**  
 11 Q You say estimate.  
 12 **A Yes.**  
 13 Q But you don't know for certain, though; right?  
 14 **A I do not.**  
 15 Q And what is the nature of Piasa Armory's  
 16 business, generally?  
 17 **A We sell firearms, provide training, gunsmith**  
 18 **services and a shooting range.**  
 19 Q So sell firearms, gunsmith, shooting range?  
 20 **A Yes, and also training. And, of course,**  
 21 **accessories, too.**  
 22 Q And you -- You personally hope that PICA is  
 23 struck down as unconstitutional; right?  
 24 **A Personally, yes.**  
 25 Q And in terms of Piasa Armory, you indicated

Page 19

1 that there may -- you estimate a 50 percent loss of  
 2 revenue. That's if PICA stays in effect; right?  
 3 **A That is as it has been since January and --**  
 4 **January 10th and going forward, I would assume so.**  
 5 Q And so if -- Excuse me. If PICA is struck  
 6 down, then you won't lose that estimated 50 percent of  
 7 revenue; is that right?  
 8 **A The revenue has already been lost for the time**  
 9 **that it's been active. However, we would assume to go back**  
 10 **to that standard revenue we had been seeing before.**  
 11 Q So is it fair to say whether or not PICA  
 12 remains in effect will affect your business?  
 13 **A Absolutely.**  
 14 Q What's the nature of your other lawsuit  
 15 against the -- against an Illinois gun regulation?  
 16 **A That was a challenge to the advertising rules**  
 17 **that were passed.**  
 18 Q What do you mean by the advertising rules?  
 19 **A Sorry. I don't recall the specifics of that**  
 20 **law. But basically, that you couldn't -- firearm**  
 21 **businesses or the industry could not advertise to -- in a**  
 22 **manner that enticed children to buy firearms, which is**  
 23 **already illegal.**  
 24 Q Are you a party in any other lawsuits?  
 25 **A No.**

Page 20

1 Q Have you -- other than the two lawsuits --  
 2 Excuse me.  
 3 Other than the one lawsuit that we just  
 4 described and the lawsuit involving Piasa Armory  
 5 challenging PICA, have you been involved in any other  
 6 lawsuits in your life?  
 7 **A Not to my knowledge.**  
 8 Q Have you testified as an expert in any other  
 9 lawsuits?  
 10 **A I have not. I have testified to the state at**  
 11 **a committee hearing, but have not been asked to testify as**  
 12 **an expert before.**  
 13 Q When did you testify to the state in a  
 14 committee hearing?  
 15 **A Before PICA was passed.**  
 16 Q What was the nature of your testimony?  
 17 **A It was explaining the nature of the FOID card,**  
 18 **what requirements individuals must go through to pass it,**  
 19 **and the process of buying a firearm in Illinois.**  
 20 Q How did you come to give that testimony?  
 21 **A I was asked by State Representative Eliik.**  
 22 Q Spell that, please.  
 23 **A E-L-I-K.**  
 24 Q And the purpose of your testimony, as you  
 25 understood it, was to lobby against the passage of PICA?

Page 21

1 **A No. I was providing information on the**  
 2 **current gun laws in Illinois and answering questions of the**  
 3 **committee.**  
 4 Q But was your personal hope that PICA would not  
 5 be passed?  
 6 **A At the time, that was not a potential. That**  
 7 **was before PICA was even -- the process was started to pass**  
 8 **PICA.**  
 9 Q What -- What time period was that testimony?  
 10 **A I believe it was in the fall before of -- of**  
 11 **2022.**  
 12 Q You understand that we're here talking about  
 13 vagueness claims that have been brought by the Langley  
 14 plaintiffs?  
 15 **A Yes.**  
 16 Q What's your understanding of what those claims  
 17 are?  
 18 **A That the -- That PICA is describing things so**  
 19 **broadly that it lacks clarity enough to allow enforcement**  
 20 **by the state and by dealers and causes a lot of difficulty**  
 21 **in purchasing and acquiring goods and services.**  
 22 Q Are you familiar with the claim in the Langley  
 23 case that the difference between the magazine capacity  
 24 limit as applicable to handguns versus long guns, are you  
 25 familiar with that claim?

Page 22

1 **A Yes.**  
 2 Q And what's your understanding of that claim?  
 3 **A That there's no way to tell if a magazine is**  
 4 **for a handgun or a long gun. There's no exclusivity on**  
 5 **many magazines.**  
 6 Q You say many magazines, but --  
 7 **A Many, many, many. Sorry.**  
 8 Q But not all magazines; right?  
 9 **A Correct.**  
 10 Q There are some magazines for which the  
 11 magazine will only work in a rifle; is that fair to say?  
 12 **A It is.**  
 13 Q And is it also fair to say that there's some  
 14 magazines for which the magazines will only function in a  
 15 handgun?  
 16 **A It could be, yes.**  
 17 Q Could be, or do you know?  
 18 **A As -- In my experience, it is. There is**  
 19 **handgun-only magazines and rifle-only magazines just as**  
 20 **there are many that interchange between both.**  
 21 Q So it's fair to say that there are rifle  
 22 magazines -- exclusive rifle magazines and exclusive  
 23 handgun magazines, and then there are some group of  
 24 magazines where they can be either for a rifle or a  
 25 handgun?

Page 23

1 **A Correct. Those rifle magazines are typically**  
 2 **not described in PICA, however. Some handgun magazines**  
 3 **are.**  
 4 Q There's another vagueness claim in the Langley  
 5 case related to the use of the term AR-type and AK-type.  
 6 Are you familiar with that claim?  
 7 **A I am.**  
 8 Q What's your understanding, in your own words,  
 9 of what that claim is?  
 10 **A That several of the items described as AR-15**  
 11 **or similar bear only facial similarities to them. Similar**  
 12 **with the AK descriptions. In fact, the SKS that's**  
 13 **described in the AK is not even remotely the same firearm.**  
 14 Q When you say facial similarities, what do you  
 15 mean?  
 16 **A Cosmetic only.**  
 17 Q What does cosmetic only mean?  
 18 **A Similar color, similar overall shape, but**  
 19 **internally different, operationally different.**  
 20 Q What does operationally different mean?  
 21 **A Manner of function of the firearm. And so if**  
 22 **the operational -- say, the gas system that causes function**  
 23 **to fire.**  
 24 Q What about cal ber?  
 25 **A Caliber can be interchanged on many of those**

Page 24

1 **firearms. So last I recall was near four dozen, five dozen**  
 2 **different calibers available for the AR-15. Both in**  
 3 **traditionally -- traditional rifle calibers and handgun**  
 4 **calibers.**  
 5 Q What's your current address?  
 6 **A For the business or my home?**  
 7 Q Your home.  
 8 **A [REDACTED]**  
 9 Q And what's your date of birth?  
 10 **A [REDACTED]**  
 11 Q And what's your occupation?  
 12 **A I am the owner of Piasa Armory.**  
 13 Q How long have you been the owner of Piasa  
 14 Armory?  
 15 **A Piasa Armory started business in 2012.**  
 16 Q What did you do before you were the owner of  
 17 Piasa Armory?  
 18 **A I owned another small gun business as well**  
 19 **called Pulaski Firearm Services from 2009 to 2012.**  
 20 Q What did you do prior to Pulaski Firearm  
 21 Services?  
 22 **A I was a security officer for a casino and in**  
 23 **other private security realms. Did process service and**  
 24 **worked as a police cadet and police explorer.**  
 25 Q As a police cadet, were you training to be a

Page 25

1 police officer?  
 2 **A I was.**  
 3 Q Why did you not become a police officer?  
 4 **A At the time, it was not something I wanted to**  
 5 **pursue.**  
 6 Q Was it your choice to not continue?  
 7 **A Yes.**  
 8 Q Prior to 2009, where were you employed?  
 9 **A That was at security companies. I worked for**  
 10 **Hamilton Security, Hurst Investigation Services, and also**  
 11 **at Argosy Alton Belle Casino.**  
 12 Q Can you briefly describe your education for  
 13 me?  
 14 **A Sure. I completed high school, have an**  
 15 **associate's degree in criminal justice.**  
 16 Q Any other degrees?  
 17 **A No.**  
 18 Q And I don't mean this as an insult. This is  
 19 just a legal term. But do you consider yourself a person  
 20 of ordinary intelligence?  
 21 **A I do.**  
 22 Q Did you ever serve in the military?  
 23 **A I did not.**  
 24 Q Have you ever been convicted of a crime?  
 25 **A No, other than traffic violations.**

Page 26

1 Q We've all been there.  
 2 And as I understand it, you're not offering  
 3 testimony as an expert witness, per Mr. Maag?  
 4 **A That's my understanding.**  
 5 Q Do you consider yourself a firearms expert?  
 6 **A I do.**  
 7 Q And what qualifications do you have to serve  
 8 as a firearms expert?  
 9 **A Extensive experience in the field and a**  
 10 **general love for the knowledge of firearms.**  
 11 Q Do you have any formal training in firearms?  
 12 **A I do not.**  
 13 Q Have you ever --  
 14 **A Sorry. I am a certified firearms instructor**  
 15 **for NRA, USCCA, and approved through the State of Illinois**  
 16 **for concealed carry instruction. And I was a firearm**  
 17 **patrol cardholder for my security work and a permanent**  
 18 **employee registration cardholder for that work as well.**  
 19 **During my time as casino employee, I worked in security**  
 20 **there and also did training for that position as well.**  
 21 Q In the course of your employment prior to  
 22 owning your own businesses, so as a security person, did  
 23 you ever have to use a firearm in the course of your work?  
 24 **A I did not.**  
 25 Q What casino did you work at?

Page 27

1 **A Argosy Alton Belle.**  
 2 Q Any others?  
 3 **A No.**  
 4 Q And did you carry a firearm in the course of  
 5 your work at that casino?  
 6 **A I did not.**  
 7 Q So what type of firearm usage did you have in  
 8 that job?  
 9 **A In that job, I had no firearm usage. In the**  
 10 **work for Hurst Investigations, I was a process server and**  
 11 **carried a firearm for that.**  
 12 Q What kind of firearm did you carry when you  
 13 were a process server?  
 14 **A At the time, I carried a Springfield XD9.**  
 15 Q What's the magazine capacity for a Springfield  
 16 XD9?  
 17 **A Sixteen rounds.**  
 18 Q And is that 16 in the magazine or 15 plus one  
 19 in the chamber?  
 20 **A Sixteen plus one.**  
 21 Q Seventeen?  
 22 **A Correct.**  
 23 Q For the firearm as a whole?  
 24 **A As a whole, yes. Sixteen in the magazine, one**  
 25 **in the firearm.**

Page 28

1 Q Have you ever published any articles, books or  
 2 other writings about firearms?  
 3 **A Not through official -- any official channels.**  
 4 **Just occasional replies or blog posts or similar things.**  
 5 Q So you've written things on the internet about  
 6 firearms?  
 7 **A I have.**  
 8 Q Where on the internet?  
 9 **A Sites like Reddit and Facebook. I've also**  
 10 **been interviewed many times by local media sources, like**  
 11 **the Telegraph in Alton, KMOV, and the RiverBender, which is**  
 12 **also an Alton publication.**  
 13 Q What have you been interviewed about?  
 14 **A Firearms.**  
 15 Q And you've given interviews about PICA?  
 16 **A I have.**  
 17 Q You're not a trained historian?  
 18 **A I am not.**  
 19 Q You're not a trained firearms historian?  
 20 **A I am not.**  
 21 Q And you're not an attorney?  
 22 **A Correct.**  
 23 (Deposition Exhibit No. 1 marked for  
 24 identification.)  
 25 Q (By Mr. Wells) In preparing -- So I'm going to



Page 29

1 go ahead and mark these. I'm going to hand you a copy of  
 2 what's labeled Affidavit of Scott Pulaski, and it's dated  
 3 January 23rd, 2023. I'll mark it as Exhibit 1.  
 4 **A Thank you.**  
 5 Q Do you recognize this document?  
 6 **A I do.**  
 7 Q What is it?  
 8 **A This is the affidavit that I filed with**  
 9 **Mr. Maag.**  
 10 Q And flipping to the last page, page six of  
 11 six, is that your signature?  
 12 **A Yes, it is.**  
 13 Q And everything in here is your testimony?  
 14 **A Correct.**  
 15 (Deposition Exhibit No. 2 marked for  
 16 identification.)  
 17 Q (By Mr. Wells) Okay. All right. I'll hand  
 18 you what I'm going to mark as Deposition Exhibit No. 2. Do  
 19 you recognize this document?  
 20 **A I do.**  
 21 Q What is it?  
 22 **A That is the statement filed with Mr. Maag.**  
 23 Q And directing your attention to page seven of  
 24 this document. Is that your signature?  
 25 **A It is.**

Page 30

1 Q And everything in Deposition Exhibit 2 is your  
 2 testimony; right?  
 3 **A Yes.**  
 4 Q And in preparing Deposition Exhibits 1 and 2,  
 5 so your January sworn statement and your May sworn  
 6 statement, you testified earlier that you just relied on  
 7 your knowledge of firearms; is that right?  
 8 **A Correct.**  
 9 Q Did you rely on anything else in preparing?  
 10 **A Knowledge of Mr. Maag as well. So we also use**  
 11 **things like the books you have here on the table, Shooter's**  
 12 **Guide, things like the Blue Book of Gun Values, and various**  
 13 **internet sources and other similar publications.**  
 14 Q So you collaborated to -- with Mr. Maag to  
 15 identify certain resources, and you relied on those  
 16 resources?  
 17 **A Correct.**  
 18 Q And are those the types of materials typically  
 19 relied upon by firearms experts?  
 20 **A Yes.**  
 21 Q How do you know?  
 22 **A Through my experience in the field and through**  
 23 **various other comments through other firearms experts.**  
 24 Q What methodology did you use in formulating  
 25 your opinions in the January 23rd, 2023, affidavit?

Page 31

1 **A Working with Mr. Maag directly on that.**  
 2 Q Was there any type of peer-reviewed  
 3 methodology that you used?  
 4 **A There's not a wide variety of peer-reviewed**  
 5 **opportunities in our industry.**  
 6 Q What methodology did you use in formulating  
 7 your opinions in the May 18, 2023, affidavit?  
 8 **A The same, working with Mr. Maag.**  
 9 Q And do you know if that's the type of  
 10 methodology typically relied upon by firearms experts?  
 11 **A I do not. I do -- I do understand that**  
 12 **firearm experts rely on their experiences in the field and**  
 13 **in publications and other informational sources they can**  
 14 **find on any relevant firearms.**  
 15 Q And you mentioned that -- You gestured to some  
 16 of the books that I have here. So, for instance, I have  
 17 the Shooter's Bible, 114th Edition. Is this the type of  
 18 thing that a firearms expert would rely upon for  
 19 information about firearms?  
 20 **A One of many sources, yes.**  
 21 Q And did you rely on some version of the  
 22 Shooter's Bible in preparing the Exhibits 1 and 2?  
 23 **A Directly, no. However, through my experience**  
 24 **of using the Shooter's Bible in the past, that knowledge**  
 25 **would have been gained from that book.**

Page 32

1 Q And the Shooter's Bible is something that you  
 2 rely upon in your work at Piasa Armory?  
 3 **A Correct. Through the course of business.**  
 4 Q Are you familiar with the Shooter's Bible  
 5 Guide to AR-15s, 2nd Edition?  
 6 **A I am.**  
 7 Q Do you own this?  
 8 **A I'm sure that I do. I have a very large book**  
 9 **shelf.**  
 10 Q And is this Shooter's Bible Guide to AR-15s  
 11 something that you rely upon in the course of your business  
 12 at Piasa Armory?  
 13 **A Occasionally, yes. Typically, that knowledge**  
 14 **is stuff that I've gained over the years of experience.**  
 15 Q All right. So I'm going to direct your  
 16 attention to Exhibit 1, your January 23, 2023, affidavit,  
 17 paragraph three. You say, "I am personally familiar with  
 18 firearms, both historical and modern, as well as firearms  
 19 regulations both in Illinois and nationally on account that  
 20 ATF, the federally agency that licenses my business, makes  
 21 me comply with all such laws and provides me a publication  
 22 listing the current ones."  
 23 That's your testimony?  
 24 **A Yes, sir.**  
 25 Q And you say ATF, the federally agency. I

Page 33

1 assume you meant federal agency?

2 **A Yes, sir.**

3 Q That's just a typo?

4 **A Yes.**

5 Q How did you develop your familiarity with

6 firearms?

7 **A I started interest in firearms when I was 12**

8 **through scouting and taking the merit badge programs that**

9 **scouting offers. And then researching independently after**

10 **that, finding every available knowledge source that I could**

11 **access at the time and consuming as much of that knowledge**

12 **as possible.**

13 Q What types of knowledge sources?

14 **A Things like radio shows, books, publications**

15 **like the Shooter's Bible. Things like the Blue Book of Gun**

16 **Values. Any other historical documentation that I could**

17 **find or other books about the history of firearms.**

18 Q What firearms do you currently own?

19 **A Wide variety from antique to modern, pistols,**

20 **rifles, shotguns, black powder, center fire, rim fire.**

21 Q And pistols is a category of firearm that you

22 understand what that means?

23 **A Yes.**

24 Q Rifles is a category of firearms, you

25 understand what that means?

Page 34

1 **A Yes.**

2 Q Shotgun is a category of firearms, you

3 understand what that means?

4 **A Yes.**

5 Q And you own firearms in each of those

6 categories?

7 **A I do.**

8 Q What's the difference between a pistol and a

9 rifle?

10 **A A pistol is typically designed to be fired**

11 **with one hand, even though modern handgun shooting**

12 **techniques use two hands. Rifles are typically designed to**

13 **be held to the shoulder and fired with two hands.**

14 Q What's the difference between a pistol and a

15 shotgun?

16 **A A pistol, the same deal. It -- It's designed**

17 **to be fired by one hand from the hand, not from the**

18 **shoulder. Where a shotgun's designed to be placed in the**

19 **shoulder. Also, pistols expel a single projectile where**

20 **shotguns typically expel multiple, with the exception of**

21 **slugs, which are a single projectile.**

22 Q What's the difference between a rifle and a

23 shotgun?

24 **A Shotguns typically have a smooth bore, with**

25 **the exception of slug barrels, which are rifle. Designed**

Page 35

1 **to expel multiple projectiles with the exception of slugs,**

2 **where rifles are designed to fire a single projectile.**

3 Q Approximately how many firearms do you own?

4 **A Approximately 100.**

5 Q And in terms of pistols, what are the specific

6 pistols you own?

7 **A I have a list, but I did not bring that list**

8 **with me. But I have --**

9 Q Just generally summarize.

10 **A A variety of pistols from major manufacturers,**

11 **Glock, Smith & Wesson, Walther, for modern items. Antiques**

12 **such as Lefauchaux Pinfire, black powder replicas, foot**

13 **lock and cap lock design, World War I and World War II**

14 **military pistols.**

15 Q What about rifles? What types of rifles do

16 you own?

17 **A Everything -- Similar. So older cap lock**

18 **design, military -- former military rifles from the early**

19 **1900's up through modern -- modern supporting rifle style,**

20 **AR-15, AK-47.**

21 Q So you own AR-15 style rifles?

22 **A I do.**

23 Q Do you own AK-47 style rifles?

24 **A I do.**

25 Q And when I say AR-15 style rifle, you

Page 36

1 understand what I mean?

2 **A I do.**

3 Q When I say AK-47 style rifle, you understand

4 what I mean?

5 **A I do.**

6 Q Do you own any other AR-type rifles?

7 **A I own AR-type rifles as listed in PICA. But**

8 **they would not be considered AR-type rifles by the**

9 **industry.**

10 Q What are you including in that category?

11 **A The Bushmaster ACR is listed in the AR-15**

12 **style, but it's more similar to an AR-180 or AR-18 style**

13 **rifle.**

14 Q And why do you say it's -- the Bushmaster ACR

15 is more similar to an AR-180?

16 **A It uses the operating system from an AR-18 or**

17 **AR-180.**

18 Q Do you have any AR-15 rifles that you would

19 agree are AR-type rifles?

20 **A I do.**

21 Q What are those?

22 **A Piasa Armory is a manufacturer, so we have our**

23 **own branded AR-15 rifles. It's called the EBR-15, and I**

24 **have several of those items.**

25 Q Do you have AK-47 style rifles that you would

Page 37

1 understand to be AK-type rifles?  
2 **A I do. I have one.**  
3 Q What's that?  
4 **A That is a Romanian WASR-10, which is listed**  
5 **specifically in PICA.**  
6 Q Does some of your knowledge about firearms  
7 come from the internet?  
8 **A It does.**  
9 Q I'm going to ask you about some websites  
10 and --  
11 **A Sure.**  
12 Q -- and to see whether or not you rely on those  
13 websites for your knowledge about firearms.  
14 Are you familiar with Pew Pew Tactical?  
15 **A I am.**  
16 Q Do you go to Pew Pew Tactical?  
17 **A Occasionally.**  
18 Q Do you rely on any information from Pew Pew  
19 Tactical?  
20 **A Not often.**  
21 Q Why not?  
22 **A That's just not one of my common sources.**  
23 Q What are your common sources from the  
24 internet?  
25 **A I typically look at sources that are more in a**

Page 38

1 **consumable format that I can use while driving back and**  
2 **forth to work or doing tasks around the shop, instead of**  
3 **sitting and directly reading these days. So things like**  
4 **Gun Talk podcast, Gun Talk media.**  
5 Q What about guns.com, have you ever gone there?  
6 **A I have.**  
7 Q And do you rely on guns.com for information  
8 about firearms?  
9 **A Occasionally. We typically use them more as a**  
10 **resource for sales than information these days.**  
11 Q How about AR Build Junkie, is that a website  
12 you're familiar with?  
13 **A It is not.**  
14 Q When I say AR Build Junkie, do you have an  
15 idea of what AR means?  
16 **A I do.**  
17 Q What is that?  
18 **A It would refer to an AR-15 style rifle and the**  
19 **accessories and parts necessary to build one.**  
20 Q Are you familiar with American Rifleman?  
21 **A I am.**  
22 Q What is that?  
23 **A That's a publication by the National Rifle**  
24 **Association.**  
25 Q Do you read American Rifleman?

Page 39

1 **A I do. I'm a life member of the National Rifle**  
2 **Association.**  
3 Q Do you consider American Rifleman a good  
4 source of information about firearms?  
5 **A I do.**  
6 Q Are you familiar with AR-15.com?  
7 **A I am.**  
8 Q Have you been to that site?  
9 **A Of course.**  
10 Q Have you ever posted on that site?  
11 **A I'm sure that I have.**  
12 Q Do you have a user name on that website?  
13 **A I do.**  
14 Q What is that?  
15 **A To my knowledge, it is ScottP8113. It's been**  
16 **a very long time since I've used that website as content**  
17 **provider, so myself providing content.**  
18 Q Say it one more time. ScottP?  
19 **A ScottP8113.**  
20 Q 8113. Okay. So you said on AR-15.com, it's  
21 been a while since you've been a content provider. But you  
22 still go there to read it?  
23 **A It's been a while since I've been able to do**  
24 **that. Unfortunately, business responsibilities keep me**  
25 **from browsing forums on a long -- for a long amount of**

Page 40

1 **time. So I typically go for a specific bit of knowledge.**  
2 Q Understood. And when you go for a specific  
3 bit of knowledge, it's a good resource to find that?  
4 **A It is.**  
5 Q How about gun manufacturers' websites, is that  
6 a source that you rely upon in your business?  
7 **A It is.**  
8 Q Do you ever look at product reviews from gun  
9 manufacturers' websites?  
10 **A Typically, I prefer customer or consumer**  
11 **reviews, be they in a forum or on sites such as YouTube,**  
12 **that we can find a more unbiased review -- review source.**  
13 Q So, for instance, if there was a gun  
14 manufacturer's website, and there were user comments, you  
15 wouldn't rely upon that as much as you would, say, comments  
16 on AR-15.com; is that fair to say?  
17 **A Not necessarily. A -- Comments provided by a**  
18 **user rather than comments provided by the company that**  
19 **indicates it's from a user.**  
20 Q Because the company might be biased?  
21 **A Correct.**  
22 Q All right. Let's see.  
23 Paragraph three again in Exhibit 1. You say,  
24 "I am personally familiar with firearms, both historical  
25 and modern, as well as firearms regulations, both in



Page 41

1 Illinois and nationally, on account that ATF, the federal  
 2 agency that licenses my business, makes me comply with all  
 3 such laws and provides me a publication listing the current  
 4 ones."  
 5 ATF licenses your business. How long have you  
 6 been licensed by ATF at Piasa Armory?  
 7 **A Since 2012.**  
 8 Q And --  
 9 **A Actually -- May I correct that? I believe**  
 10 **2013 is when we started with the license.**  
 11 Q And you've maintained a federal firearms  
 12 license for Piasa Armory since that time?  
 13 **A Yes, sir.**  
 14 Q And generally speaking, you've been complying  
 15 with ATF regulations; is that fair to say?  
 16 **A Yes.**  
 17 Q How do you, as a business at Piasa Armory,  
 18 ensure that you're in compliance with ATF regulations?  
 19 **A I am, in addition to managing the day-to-day**  
 20 **operation, the compliance director for Piasa Armory also.**  
 21 Q What does that involve?  
 22 **A That involves reviewing regularly every**  
 23 **firearm record, every transaction record that goes through**  
 24 **our company, and providing regular training as the Firearm**  
 25 **Dealer Licensing Act requires.**

Page 42

1 Q Do you review any publications from ATF?  
 2 **A I do. They provide a national firearms law**  
 3 **update, which they just recently updated.**  
 4 Q You mentioned here, "ATF provides me a  
 5 publication listing the current ones."  
 6 What are you referring to there?  
 7 **A I do not recall the title of that, but it's a**  
 8 **regularly updated publication that they provide.**  
 9 Q Okay. I'm going to mark Exhibit 3.  
 10 (Deposition Exhibit No. 3 marked for  
 11 identification.)  
 12 Q (By Mr. Wells) I'm showing Mr. Pulaski what I  
 13 have marked as Deposition Exhibit No. 3. It's a document  
 14 titled State Laws and Published Ordinances, Illinois. Is  
 15 this a document that you've seen before?  
 16 **A Yes.**  
 17 Q And what is it?  
 18 **A This lists all of the relevant state laws**  
 19 **pertaining to firearms that we're required to follow by ATF**  
 20 **and by the state law.**  
 21 Q And when you mentioned earlier that you review  
 22 information from the state and also from the federal  
 23 government, this is the type of thing you're referring to?  
 24 **A Yes, this and some of the things that are**  
 25 **provided on the Illinois General Assembly website and**

Page 43

1 **public acts.**  
 2 Q I'm going to -- I'm not going to go too deep  
 3 into these, but I just want to make sure that we're talking  
 4 about the same rough thing.  
 5 MR. WELLS: We're on four?  
 6 (Deposition Exhibit No. 4 marked for  
 7 identification.)  
 8 Q (By Mr. Wells) I'm going to hand you what's --  
 9 what I'm marking as Deposition Exhibit 4. Are you familiar  
 10 with this document?  
 11 **A I am.**  
 12 Q What is it?  
 13 **A It's the Federal Firearms Regulations**  
 14 **Reference Guide.**  
 15 Q Is this a document that you use in the course  
 16 of your business at Piasa Armory?  
 17 **A It is.**  
 18 Q Okay. In paragraph four of your January 23rd,  
 19 2023, affidavit, which I've marked as Deposition Exhibit 1,  
 20 you say, "In addition to being a firearms dealer, Piasa  
 21 Armory and myself teach Illinois State Police certified  
 22 concealed carry classes, both new and renewal."  
 23 **A Yes.**  
 24 Q And as a certified concealed carry instructor,  
 25 you're familiar with the Firearm Concealed Carry Act in

Page 44

1 Illinois?  
 2 **A I am.**  
 3 Q And you also have a concealed carry license  
 4 yourself?  
 5 **A I do.**  
 6 Q Do you carry a concealed firearm in Illinois?  
 7 **A I do.**  
 8 Q What firearm do you carry?  
 9 **A I typically carry either a Walther PPQ or a**  
 10 **Glock 19 or 17.**  
 11 Q What's the magazine capacity on a Walther PPQ?  
 12 **A Either a 15 in the magazine or 19 in the**  
 13 **magazine.**  
 14 Q And now that PICA is in effect, if you're  
 15 carrying your Walther PPQ, do you understand which magazine  
 16 you should carry?  
 17 **A I do.**  
 18 Q And which magazine is that?  
 19 **A Fifteen round is required by PICA.**  
 20 Q With respect to your Glock 19 or 17, what are  
 21 the magazine capacities for the Glock 19? Let's start with  
 22 that one.  
 23 **A Standard capacity is 15 in the magazine;**  
 24 **however, it can accept larger magazines, 17, or magazines**  
 25 **with extensions up to 33 or 50.**

Page 45

1 Q And when you carry your Glock 19 now, what  
2 size magazine do you carry?  
3 **A Fifteen now.**  
4 Q And is that because of PICA?  
5 **A It is.**  
6 Q So you understand that you can no longer carry  
7 the 17-round magazine for your Glock 19?  
8 **A I do.**  
9 Q How about your Glock 17, what's the magazine  
10 capacity for that?  
11 **A Seventeen is standard. Glock now makes**  
12 **15-round magazines that also fit that firearm.**  
13 Q Do you have any of those 15-round magazines?  
14 **A I do not.**  
15 Q Could you acquire them?  
16 **A I could.**  
17 Q And you would know that in acquiring the  
18 15-round magazine, that would be something that would  
19 comply with PICA; right?  
20 **A I do; however, I've chosen to not carry the 17**  
21 **and rather just carry the 19.**  
22 Q And do you own any 17-round magazines for the  
23 Glock 19?  
24 **A I do.**  
25 Q But now you just carry the 15-round magazines

Page 46

1 for the Glock 19; right?  
2 **A Correct.**  
3 Q And you understand that as a concealed carry  
4 license holder, you're allowed to carry a concealed  
5 handgun; correct?  
6 **A Correct.**  
7 Q You're not allowed to carry a concealed rifle;  
8 correct?  
9 **A Correct.**  
10 Q You're not allowed to carry a concealed  
11 shotgun; correct?  
12 **A Correct.**  
13 Q All right. I'm going to direct your attention  
14 to Exhibit 2. So this is your May 18, 2023, declaration,  
15 paragraph 26.  
16 You say, "Likewise, there are no objective  
17 standards to determine whether a given firearm is an  
18 AK-type, an AR-type or something else. In fact, even  
19 elicited examples are oftentimes not within the parameters of  
20 what even most firearms experts would consider to be an  
21 AK-type, like the SKS or an AR-type."  
22 That was your testimony?  
23 **A Yes.**  
24 Q And where it says, "An AK-type like the SKS of  
25 an AR-type," you meant "or"; right?

Page 47

1 **A Yes.**  
2 Q And that was just a typo?  
3 **A Correct.**  
4 Q You believe there are, quote, parameters,  
5 close quote, for what most firearms experts would consider  
6 an AR-type; correct?  
7 **A Correct.**  
8 Q In your mind, what are the parameters that  
9 most firearms expert would consider to be an AR-type?  
10 **A An AR-type would be a firearm with typically a**  
11 **16 or 20-inch barrel, adjustable or fixed stop, pistol**  
12 **grip, detachable magazine, and using a -- a direct**  
13 **impingement gas system, rotary-operated bolt.**  
14 Q Why did those design elements make something  
15 an AR-type?  
16 **A Because that's what the designer of the AR**  
17 **used to create that firearm.**  
18 Q Who was the designer of the AR?  
19 **A Eugene Stoner.**  
20 Q Who was Eugene Stoner?  
21 **A Eugene Stoner worked for ArmaLite and several**  
22 **other companies in the mid 1900s, 1950s, 1960s, to develop**  
23 **the AR-15 and several other designs.**  
24 Q And you understand that when people use the  
25 term AR-type today, they are referencing firearms that are

Page 48

1 connected to that AR-15 that Eugene Stoner denied --  
2 designed?  
3 **A Some people -- Some people reference that, and**  
4 **some tend to refer to any firearm that looks vaguely like**  
5 **it as an AR-type rifle.**  
6 Q And in terms of how you went about identifying  
7 those particular features that you would consider  
8 associated with an AR-type firearm, how did you identify  
9 those particular features?  
10 **A Based on the designs that Stoner produced.**  
11 Q Would you consider an AR-10 an AR-type rifle?  
12 **A Similar, but different. It's -- Shares a lot**  
13 **of the same characteristics. But the AR-10 was typically a**  
14 **machine gun designed for the military. There's been a**  
15 **civilian variant of that that's been developed and used.**  
16 Q In your experience, as someone in the firearms  
17 industry, would you say that the AR-15 or the AR-10 is more  
18 popular among consumers?  
19 **A AR-15, with AR-10 being very close.**  
20 Q What is an AR pistol?  
21 **A An AR pistol would be an AR-15 that complies**  
22 **with the ATF's definitions of handgun.**  
23 Q Why does it have AR in the name?  
24 **A Because the design is based from the AR-15,**  
25 **which is the ArmaLite rifle.**

Page 49

1 Q Have you ever seen AR, just those two letters,  
2 A-R, used to refer to a firearm?  
3 **A Yes.**  
4 Q Did you understand what that meant?  
5 **A I do, through my experience, but I've seen**  
6 **many people be confused and refer to anything that is a**  
7 **rifle that shares similar characteristics to be called an**  
8 **AR or even an AK.**  
9 Q Piasa Armory has a website; right?  
10 **A It does.**  
11 Q Who's responsible for the content of that  
12 website?  
13 **A I am.**  
14 Q Do you write it yourself?  
15 **A I do.**  
16 Q I'm marking Deposition Exhibit 5.  
17 (Deposition Exhibit No. 5 marked for  
18 identification.)  
19 Q (By Mr. Wells) Do you recognize this document?  
20 **A I do.**  
21 Q What is it?  
22 **A This is an example of gunsmith services that**  
23 **we offer.**  
24 Q Would you agree that this appears to be a  
25 printout from the Piasa Armory website?

Page 50

1 **A It is.**  
2 Q And do you see at the bottom left hand it says  
3 the URL for Piasa Armory?  
4 **A Yes.**  
5 Q And it's specifically the gunsmith page?  
6 **A Yes.**  
7 Q Who's the audience for your website?  
8 **A Any -- Anyone. So young, old, novice,**  
9 **experienced, professional.**  
10 Q Is it fair to say that the audience for your  
11 website is potential customers for Piasa Armory?  
12 **A It is, but also not potential customers. Our**  
13 **business operates as education also.**  
14 Q And when you say education -- it operates as  
15 education, what do you mean?  
16 **A Educational I should say. So our goal, our**  
17 **company motto is creating a culture of responsible firearm**  
18 **ownership, which is being willing to provide information to**  
19 **anyone who asks, not just potential customers, helping to**  
20 **teach safe handling, safe operation, and basic familiarity.**  
21 Q When you write things on your website, do you  
22 use terminology -- on the Piasa Armory website, do you use  
23 terminology that you believe your customers will  
24 understand?  
25 **A I work to -- Jargon is a difficult thing in**

Page 51

1 **our industry. Tends -- It tends that with more knowledge**  
2 **in the industry, more jargon is used, as in many**  
3 **industries. So I work to eliminate jargon as much as**  
4 **possible, but it doesn't always work.**  
5 Q Directing your attention to where it says  
6 AR-15 build room. Directly under that, it says, "For \$40,  
7 you can have access to our AR build room."  
8 Do you see that?  
9 **A Yes.**  
10 Q Did you write that sentence?  
11 **A I did.**  
12 Q And when you wrote that sentence, you had an  
13 understanding of what AR meant?  
14 **A I did, and especially because AR-15 build room**  
15 **is written two lines above it.**  
16 Q And from the context, you can tell that AR  
17 means AR-15; is that fair to say?  
18 **A Yes.**  
19 Q You got to wait for me to finish.  
20 **A Yes.**  
21 Q That was a yes.  
22 And what does AR refer to there?  
23 **A In this case, it refers to AR-15.**  
24 Q What is your AR-15 -- I'm sorry. Let's strike  
25 that.

Page 52

1 What is your AR build room?  
2 **A We don't have an AR build room. It's an AR-15**  
3 **build room. As I mentioned, it was an example of jargon or**  
4 **poor proofreading.**  
5 Q But you call it an AR build room. Was that  
6 just a shorthand?  
7 **A Yes.**  
8 Q Do customers use the AR build room?  
9 **A Not lately.**  
10 Q Prior to January 10, 2023, did customers use  
11 the AR build room?  
12 **A Yes.**  
13 Q What did they use the AR build room for?  
14 **A Typically installing parts and accessories.**  
15 **Or we would also offer to teach how to properly assemble an**  
16 **AR-15 so it would operate safely.**  
17 Q Did customers ever use the AR build room to  
18 assemble firearms other than an AR-15?  
19 **A Typically not, but I'm sure that it's happened**  
20 **over the years.**  
21 Q Do you recall any specific occasions where  
22 someone assembled something other than AR-15?  
23 **A I'm sure that someone has assembled a Glock**  
24 **pistol or other similar pistols.**  
25 Q Has a customer ever built an AR-7 in your AR



Page 53

1 build room?  
2 **A That would be rather difficult.**  
3 Q Is that a no?  
4 **A That -- To my knowledge, no.**  
5 Q How about an AR-5? Has a customer ever used  
6 an AR -- your AR build room to construct an AR-5?  
7 **A Not to my knowledge.**  
8 Q And the reason you offered, prior to  
9 January 10, 2023, an AR build room is because the AR-15 is  
10 very common; right?  
11 **A It is.**  
12 Q All right. I'm going to show you -- set that  
13 one to the side.  
14 (Deposition Exhibit No. 6 marked for  
15 identification.)  
16 Q (By Mr. Wells) I'm handing you what I'm  
17 marking as Deposition Exhibit No. 6. Are you familiar with  
18 this document?  
19 **A I am.**  
20 Q How are you familiar with it?  
21 **A This was provided to all FFL's by the ATF.**  
22 Q And you reviewed it in your capacity as an  
23 owner of Piasa Armory; is that right?  
24 **A I did.**  
25 Q And you reviewed it when ATF issued it?

Page 54

1 **A Yes.**  
2 Q And it says, "March 22nd, 2022, open letter to  
3 all federal firearms licensees."  
4 So you reviewed it approximately in March of  
5 2022; is that fair to say?  
6 **A On or about that.**  
7 Q March, April?  
8 **A Yes.**  
9 Q Around the spring of 2022?  
10 **A Yes.**  
11 Q I'm directing your attention to the second  
12 paragraph. You see it says FRT?  
13 **A Yes.**  
14 Q Do you have an understanding of what FRT means  
15 in that sentence?  
16 **A I do.**  
17 Q What is that?  
18 **A That is a forced reset trigger.**  
19 Q So in paragraph two of Deposition Exhibit 6,  
20 it says, "These particular FRTs," meaning forced reset  
21 triggers, "are being marketed as replacement triggers for  
22 AR-type firearms."  
23 Do you see that?  
24 **A I do.**  
25 Q And when you read this document in the spring

Page 55

1 of 2022, did you have an understanding as to what AR-type  
2 firearms meant?  
3 **A As a member of the industry with experience, I**  
4 **do.**  
5 Q And this was a document that you reviewed that  
6 came from ATF; is that right?  
7 **A Yes.**  
8 Q And when you're reviewing documents from ATF,  
9 they regulate firearms; right?  
10 **A They do.**  
11 Q So they use firearms terminology that  
12 regulated entities will understand?  
13 **A Traditionally.**  
14 Q In the spring of 2022, when you got Deposition  
15 Exhibit 6, did you reach out to ATF seeking clarification  
16 as to what they meant about AR-type firearms?  
17 **A I did not, as I understood what they meant by**  
18 **AR-type firearms. Fires that use the fire control group of**  
19 **an AR.**  
20 Q What is a fire control group?  
21 **A Typically the trigger and hammer.**  
22 (Deposition Exhibit No. 7 marked for  
23 identification.)  
24 Q (By Mr. Wells) All right. I'm going to hand  
25 you another exhibit I'm marking as Deposition Exhibit

Page 56

1 No. 7.  
2 **A Thank you.**  
3 MR. MAAG: Thank you.  
4 Q (By Mr. Wells) Do you recognize what I've  
5 marked as Deposition Exhibit No. 7?  
6 **A I do.**  
7 Q What is it?  
8 **A This is the federal definition of a frame or**  
9 **receiver.**  
10 Q What is a frame or receiver in your own words?  
11 **A That'd be the component of a firearm that**  
12 **contains the working parts of the firearm.**  
13 Q Directing your attention to paragraph two on  
14 Deposition Exhibit 7, the first page. Do you see it says,  
15 "The term receiver means the part of a rifle, shotgun or  
16 projectile weapon other than a handgun or variance thereof  
17 that provides housing or a structure for the primary  
18 component designed to block or seal the breach prior to  
19 initiation of the firing sequence, i.e., bolt, breach lock  
20 or equivalent, even if pins or other attachments are  
21 required to connect to such component to the housing or  
22 structure?"  
23 **A I do.**  
24 MR. MAAG: I'm going to interpose an  
25 objection. I think the U.S. Court of Appeals for the Fifth

Page 57

1 Circuit has stayed the implementation of these rules.  
 2 MR. WELLS: Are we in the Fifth Circuit?  
 3 MR. MAAG: No, but I think it's a nationwide  
 4 injunction.  
 5 MR. WELLS: Is it? Okay. All right.  
 6 MR. MAAG: I mean, you can proceed. I just  
 7 want --  
 8 MR. WELLS: Right. Fair enough.  
 9 Q (By Mr. Wells) With respect to paragraph  
 10 three, do you see where it says the terms variant and  
 11 variance thereof?  
 12 **A I do.**  
 13 Q And do you understand what's meant by variant?  
 14 **A I do.**  
 15 Q Do you see in paragraph three where it says,  
 16 "For example, an AK-type firearm with a short stock, i.e.,  
 17 pistol grip, is a pistol variant of an AK-type rifle. An  
 18 AR-type firearm with a short stock, i.e., pistol grip, is a  
 19 pistol variant of an AR-type rifle. And a revolving  
 20 cylinder shotgun is a shotgun variant of a revolver."  
 21 Do you see that sentence?  
 22 **A I do.**  
 23 Q And do you understand the use of the phrase  
 24 AR-type firearm in that?  
 25 **A Thanks to my experience in -- in the industry,**

Page 58

1 **yes, I do.**  
 2 Q And do you understand what AK-type firearm  
 3 means in that?  
 4 **A Again, thanks to my experience in the**  
 5 **industry, I do.**  
 6 Q And I can represent to you that 27 CFR Section  
 7 478.12, which is Deposition Exh bit 7, which we've been  
 8 looking at, it took effect in August -- August 24th of  
 9 2022. And at Piasa Armory, you would have complied with  
 10 the regulation when it was in effect; correct?  
 11 **A Correct.**  
 12 MR. MAAG: Subject to my belief it has been  
 13 stayed by the Fifth Circuit.  
 14 MR. WELLS: That's why I used past tense.  
 15 MR. MAAG: Right.  
 16 Q (By Mr. Wells) Have you filed any lawsuits  
 17 challenging the regulation in Deposition Exhibit 7?  
 18 **A Not at this time.**  
 19 Q And you mentioned earlier that you're familiar  
 20 with Shooter's Bible?  
 21 **A I am.**  
 22 Q And I think you also mentioned that you're  
 23 familiar with Shooter's Bible Guide to AR-15s --  
 24 **A Yes.**  
 25 Q -- correct?

Page 59

1 (Deposition Exhibit No. 8 marked for  
 2 identification.)  
 3 Q (By Mr. Wells) I'm handing you what I've  
 4 marked as Deposition Exhibit 8, which I can represent to  
 5 you is an excerpt, so a collection of pages from Shooter's  
 6 Bible Guide to AR-15, 2nd Edition.  
 7 **A Okay.**  
 8 Q I'm directing your attention to the last page.  
 9 MR. MAAG: Printed in China.  
 10 Q (By Mr. Wells) Are you familiar with Doug  
 11 Howlett?  
 12 **A Not personally, but as a writer, yes.**  
 13 Q So you're familiar with his writing?  
 14 **A Yes.**  
 15 Q And it says here that he worked as an editor  
 16 of American Hunter magazine. Are you familiar with that  
 17 magazine?  
 18 **A I am.**  
 19 Q And is it a good source of information about  
 20 firearms?  
 21 **A I have not read American Hunter magazine as**  
 22 **referential material.**  
 23 Q It says here Rob Manning is another one of the  
 24 authors, and he's the current editor, at least as of this  
 25 publication date, of Gun World magazine. Are you familiar

Page 60

1 with Gun World magazine?  
 2 **A I am.**  
 3 Q Is that a good source of information about  
 4 firearms?  
 5 **A It can be.**  
 6 Q I'm directing your attention to the second  
 7 paragraph on this page. It says, "In this complete book of  
 8 AR style firearms, you can peruse the products of all  
 9 manufacturers, learn about the evolution of the AR from its  
 10 uses in the military in the 1960s as well as gain essential  
 11 knowledge on the parts and functions of the rifle. Also  
 12 included are chapters on customizing and accessorizing ARs  
 13 and much more."  
 14 Do you have an understanding as to what AR  
 15 means in this paragraph?  
 16 **A I do, as an expert in the industry. However,**  
 17 **a layman may have difficulty without the reference to the**  
 18 **top of the page referring to AR-15 rifle.**  
 19 Q And we see here the evolution of the AR from  
 20 its uses in the military in the 1960s. Do you have an  
 21 understanding as to what that's referring to?  
 22 **A The AR was part of the military design**  
 23 **program. However, it was also a civilian rifle during that**  
 24 **same time.**  
 25 Q And in that time period, is that when,

Page 61

1 roughly, Eugene Stoner was involved with the design of the  
2 AR-15?  
3 **A Yes.**  
4 Q And the AR-15 became the M-16; is that right?  
5 **A It did. It also became a Colt firearm that**  
6 **was sold to the civilian market.**  
7 Q What's the difference between the civilian  
8 Colt firearm that's an AR-15 and the military AR-15 that  
9 was named the M-16?  
10 **A The M-16 is a select-fire firearm machine gun,**  
11 **so it's able to fire more than one projectile when pulling**  
12 **the trigger.**  
13 Q Any other differences?  
14 **A On the outside, no, but definitionally, that's**  
15 **what makes the difference.**  
16 Q And any other differences relate to that  
17 effectuating that difference between select fire and  
18 semi-automatic fire; is that right?  
19 **A Minor differences by the manufacturer, yes.**  
20 **Things that would prevent somebody from easily converting a**  
21 **civilian AR-15 into an M-16.**  
22 Q But to the extent that there are differences  
23 between a military M-16 and the AR-15, the --  
24 **A They --**  
25 Q Let me just finish.

Page 62

1 The differences would relate to, again, the  
2 internal mechanisms that either facilitate, in the case of  
3 an M-16, automatic fire or aren't there in a semi-automatic  
4 civilian version; is that correct?  
5 **A Correct. And minor cosmetic details.**  
6 Q All right. So sticking with this exhibit,  
7 I'll direct your attention to the table of contents. Do  
8 you see where it says, Chapter 4, AR Rifle Models?  
9 **A I do.**  
10 Q And do you have an understanding of what that  
11 means?  
12 **A I do, as an industry member.**  
13 Q And if you were to look at chapter four, what  
14 would you expect to see there?  
15 **A I would assume I would see AR-15s, AR-10s,**  
16 **AR-18s, and other variants.**  
17 Q Would you expect to see an AR-7?  
18 **A Typically not. That doesn't fall on a similar**  
19 **style to the AR-15.**  
20 Q What about an AR-5, would you expect to see an  
21 AR-5?  
22 **A Not necessarily.**  
23 Q Directing your attention to page 51 at the  
24 bottom of this same exhibit, Exhibit 8. And the first  
25 sentence, I'm going to read it to you, "Following is

Page 63

1 undoubtedly the most comprehensive listing of current AR  
2 style rifle models available in print or on the web,  
3 though, it is by no means exhaustive."  
4 Do you see that?  
5 **A I do.**  
6 Q And do you understand what AR style rifle  
7 models means in this sentence?  
8 **A I do. Again, thanks to my industry knowledge**  
9 **and the title of the book.**  
10 Q And directing your attention to the last  
11 sentence in this paragraph that starts with "and."  
12 "And admittedly, with so many small gunmakers  
13 coming into the fold and just as quickly falling back out  
14 of it, capturing every manufacturer is a target even a  
15 custom built AR couldn't hit."  
16 Do you see that?  
17 **A I do.**  
18 Q Do you have an understanding of what custom  
19 built AR means here?  
20 **A I do.**  
21 Q What is that understanding?  
22 **A That would refer to somebody who builds a**  
23 **custom AR-15 or AR-10 typically in the industry.**  
24 Q In the first sentence that we looked at just a  
25 second ago, the author stated, "It's by no means an

Page 64

1 exhaustive list of AR rifle models."  
2 Do you agree that it would be very difficult  
3 to make an exhaustive list of all AR style rifle models?  
4 **A I do.**  
5 Q Do you agree that it would be possible to make  
6 a large, but not necessarily complete, list of AR style  
7 rifle models?  
8 **A I do. The state's done that with the PICA**  
9 **listing of AR-15 and variants.**  
10 Q And, in fact, this Shooter's Bible, Guide to  
11 AR-15s, 2nd Edition, which I believe you said you have, the  
12 authors here have compiled quite a list of AR-15 models;  
13 right?  
14 **A They have made a large list, right.**  
15 Q And if I asked you personally, based on your  
16 knowledge, to compile a list of 50 AR rifle models, you  
17 could do that; correct?  
18 **A Probably.**  
19 Q Could you do more than 50?  
20 **A Probably.**  
21 Q I'm going to direct your attention to appendix  
22 one in this same exhibit. And I'm not going to ask you to  
23 look at it in detail, but does it appear to be a list of AR  
24 manufacturers?  
25 **A It is. Not anywhere near complete.**



Page 65

1 Q And there are 141, based on my count, AR  
 2 manufacturers identified here. You said not anywhere near  
 3 complete. Why do you say that?  
 4 **A Because of the nature of firearms**  
 5 **manufacturing and the nature of the AR-15 manufacturing.**  
 6 **For example, ourselves, we don't physically**  
 7 **manufacture our own. We use a process called a variance to**  
 8 **produce our AR-15 lower, half of the receiver system for**  
 9 **the AR-15. So without intimate industry knowledge, no one**  
 10 **could compile such an exhaustive list.**  
 11 Q You said variance?  
 12 **A Variance. Not variant. Not multiple variant,**  
 13 **but variance and approval through ATF for another company**  
 14 **to produce the firearm for us.**  
 15 Q How many AR-15s does -- prior to -- So let's  
 16 say 2022. How many AR-15s would Piasa Armory have produced  
 17 itself?  
 18 **A We have only produced 150.**  
 19 Q Do you know who the largest AR-15 manufacturer  
 20 is in the United States?  
 21 **A Not immediately, but with a short search, I'm**  
 22 **sure I could find.**  
 23 Q Who do you -- What are the companies that you  
 24 think might be in that category or close to the top?  
 25 **A Immediately I would say Palmetto State Armory.**

Page 66

1 Q Any others?  
 2 **A Aero Precision. A-E-R-O.**  
 3 Q Do you have any sense of how many AR-15s  
 4 Palmetto State Armory produces in a given year?  
 5 **A I do not.**  
 6 Q Is it more than 150?  
 7 **A Absolutely.**  
 8 Q Do you think it's in the tens of thousands?  
 9 **A I would wager it's near six figures.**  
 10 Q And out of the 141 manufacturers that are  
 11 listed here in this exhibit, based on your knowledge, how  
 12 many are in that kind of above 10,000 category of AR-15s  
 13 produced each year?  
 14 **A I would presume probably 10 percent of the**  
 15 **overall list of manufacturers.**  
 16 Q And would you agree that the number of  
 17 manufacturers of AR-type rifles is a reflection of the  
 18 popularity of AR-type rifles?  
 19 **A I would.**  
 20 Q I'm going to hand you this section of PICA  
 21 where it's codified, meaning put in the law books.  
 22 (Deposition Exhibit No. 9 marked for  
 23 identification.)  
 24 MR. MAAG: They had law books hundreds of  
 25 years before the codification.

Page 67

1 MR. WELLS: True.  
 2 MR. MAAG: Thank you.  
 3 MR. WELLS: They used to write on sheepskin.  
 4 MR. MAAG: Well, I never did.  
 5 MR. WELLS: Me either.  
 6 Q (By Mr. Wells) All right. I have marked for  
 7 identification purposes Deposition Exhibit 9, which I can  
 8 represent to you is a printout from the Illinois General  
 9 Assembly website of 720 ILCS 5/24-1.9.  
 10 Do you recognize that statute?  
 11 **A I do.**  
 12 MR. WELLS: Oh, I didn't hand it to you.  
 13 Q (By Mr. Wells) And do you recognize this to be  
 14 a section of PICA?  
 15 **A I do.**  
 16 Q All right. I'm directing your attention to  
 17 the second page. Under subpart J in the middle of the page  
 18 and then small Roman numeral ii, two.  
 19 MR. MAAG: We're on page two?  
 20 MR. WELLS: Yep.  
 21 Q (By Mr. Wells) Do you see where it says all  
 22 AR-types?  
 23 **A I do.**  
 24 Q Okay. So I want you to go from -- I want you  
 25 to review all of the models that are listed under J, small

Page 68

1 Roman two, which it goes from one to 43 on the next page --  
 2 **A Uh-huh (yes).**  
 3 Q -- and tell me which of the models that are on  
 4 this list you do not believe are probably -- properly  
 5 characterized as an AR-type.  
 6 **A The AR-10, again, is similar, but that would**  
 7 **be a -- a different type of system. It operates similarly**  
 8 **to an AR-15, but it's larger, different caliber. It has**  
 9 **its own platform basically. Parts -- Many parts are not**  
 10 **interchangeable, although some are. Items like four, the**  
 11 **ArmaLite .22 Carbine. Things like the Beretta AR-70,**  
 12 **Bushmaster ACR. The Chiappa firearms M4.**  
 13 **So the -- Let's see. So the -- the -- is**  
 14 **that -- 36, Sig Sauer 516 and MCX rifles are similar, but**  
 15 **have a different operating system. And that would be it.**  
 16 Q Okay. So out of the 43 models listed under  
 17 section J(ii), you've identified six that you agree -- that  
 18 you think are not properly characterized as AR-types; is  
 19 that right?  
 20 **A Yes.**  
 21 Q So is it fair to say that the remaining 37  
 22 types listed under J(ii), make and model of particular  
 23 rifles, are fairly considered AR-types?  
 24 **A Yes. AR-15 types.**  
 25 Q All right. I'm going to direct you back to --

Page 69

1 We're going to go back and forth with this one a little  
 2 bit, so keep it handy.  
 3 I want you to go back to your May 19th  
 4 declaration, so that's Exhibit 2. And I'm going to direct  
 5 your attention to paragraph 21 where you say that,  
 6 "ArmaLite M-15 .22 LR carbine is designed to look like an  
 7 early prototype AR-15, circa about 1964, by is in" -- I  
 8 think you meant "but is in."  
 9 **A Correct.**  
 10 Q "A different caliber, has no gas system and  
 11 completely different operating system and uses different  
 12 magazines."  
 13 That was your testimony; is that right?  
 14 **A Correct.**  
 15 Q I'm going to hand you what I'm going to mark  
 16 as Deposition Exhibit 10.  
 17 (Deposition Exhibit No. 10 marked for  
 18 identification.)  
 19 Q (By Mr. Wells) Have you seen this document?  
 20 **A I have.**  
 21 Q What is it?  
 22 **A This is the Assault Weapon Identification**  
 23 **Guide, and it was put together by the state police.**  
 24 Q I'm going to direct your attention to -- Well,  
 25 let me ask you this: This Assault Weapon Identification

Page 70

1 Guide, is this something that you've looked at and -- for  
 2 purposes of running Piasa Armory?  
 3 **A Yes.**  
 4 Q Directing your attention to page 28, top of  
 5 the page next to ArmaLite M-15 .22 LR carbine. Do you  
 6 recognize that photograph?  
 7 **A I do.**  
 8 Q And what is that?  
 9 **A That's an ArmaLite M-15 .22 LR carbine.**  
 10 Q Why do you believe an ArmaLite M-15 .22 LR  
 11 carbine is not an AR-type?  
 12 **A Shares cosmetic similarities, but in the same**  
 13 **way that a Ruger 10/22, which is pictured also in this**  
 14 **document, is not the -- is -- is just dressed up**  
 15 **differently than the tactical model that's pictured in this**  
 16 **document. So the internals are different.**  
 17 Q Do you agree that the rifle depicted on page  
 18 28 of Deposition Exhibit 10 next to ArmaLite M-15 .22 LR  
 19 carbine is a semi-automatic rifle?  
 20 **A Yes.**  
 21 Q Do you agree that that same rifle has a  
 22 detachable magazine?  
 23 **A I do.**  
 24 Q Do you agree that that rifle has a pistol  
 25 grip?

Page 71

1 **A I do.**  
 2 Q Do you agree that that rifle has a flash  
 3 suppressor?  
 4 **A This one does.**  
 5 Q Do you agree that the rifle depicted on  
 6 page 28 next to ArmaLite M-15 .22 LR carbine -- carbine has  
 7 a barrel shroud?  
 8 **A I would not call that a barrel shroud. I**  
 9 **would call it a hand guard. It's simply meant to protect**  
 10 **the barrel so the user doesn't burn themselves while**  
 11 **shooting, similar to many other semi-automatic and**  
 12 **bolt-action rifles.**  
 13 Q And you're referring to the -- I guess you  
 14 can't really see the -- the color here. But to shield the  
 15 second hand of the user from touching the barrel; is that  
 16 right?  
 17 **A Correct. Correct.**  
 18 Q Because the barrel gets hot?  
 19 **A It's the case with every firearm that's fired.**  
 20 Q And are you familiar with -- in Deposition  
 21 Exhibit 9, which is the provision of PICA, the definition  
 22 of assault weapon that uses features?  
 23 **A Yes.**  
 24 Q Would you agree that the firearm we were just  
 25 looking at in Deposition Exhibit 10, the top of page 28,

Page 72

1 the ArmaLite M-15 .22 LR carbine, it has features that are  
 2 listed under Section 1.9 (a)1(A?)  
 3 **A It does.**  
 4 Q You mentioned in your declaration from May 19,  
 5 2023, in paragraph 21, that the ArmaLite M-15 .22 LR  
 6 carbine uses different magazines. What do you mean?  
 7 **A The magazine for the M-15 .22 carbine is only**  
 8 **capable of accepting 22 long rifle ammunition, rather than**  
 9 **a 223 or 556 ammunition that's common for the AR-15 rifle.**  
 10 Q So the caliber of ammunition for the M-15 .22  
 11 LR is different than the caliber of ammunition used in most  
 12 AR-15 models?  
 13 **A Correct.**  
 14 Q And in order for a magazine to be able to be  
 15 interchangeable, you need to have the same caliber of  
 16 ammunition between the two firearms that you're planning to  
 17 use that magazine in; is that fair to say?  
 18 **A Not necessarily.**  
 19 Q Why not?  
 20 **A Modern AR-15s are capable of accepting dozens**  
 21 **of different calibers of ammunition. Some of those share**  
 22 **the same magazines with 223. For example, 50 Beowulf for**  
 23 **58 SOCOM -- 458 SOCOM uses a standard 223 magazine.**  
 24 Q So there are multiple calibers that can fit  
 25 into one magazine; is that fair to say?

Page 73

1 **A Correct.**  
2 Q You do have to have at least one overlapping  
3 caliber between two firearms to be able to use the same  
4 magazine, though; right?  
5 **A In general.**  
6 Q Is that a yes?  
7 **A Yes.**  
8 Q All right. Let's go back to your declaration  
9 paragraph, paragraph 22. This is the May 19 declaration,  
10 Exhibit 2.  
11 In paragraph 22, you mentioned the Beretta  
12 AR-70. You say, "The Beretta AR-70 has nothing in common  
13 with the AR-15 except caliber. And while the AR-15 is made  
14 from machined aluminum, the AR-70 is made from largely  
15 stamped steel. No parts between the two interchange."  
16 Is that your testimony?  
17 **A Correct.**  
18 Q And when we were looking at Exhibit 9, the  
19 PICA list and the PICA provisions, you mentioned that the  
20 ArmaLite -- I'm sorry -- that the AR-70 is one of -- I'm  
21 sorry. The Beretta AR-70 is one of the models listed under  
22 Section J(ii) under AR-type that you don't think is  
23 properly characterized as an AR-type; is that right?  
24 **A Correct.**  
25 Q Is it fair to say that the original AR-70 was

Page 74

1 a fully automatic rifle issued to the Italian military?  
2 **A Yes.**  
3 Q Does the AR-70 use the same caliber of  
4 ammunition as the AR-15 chambered in 5.56 NATO?  
5 **A Yes.**  
6 Q The AR-70 was designed by Beretta, an Italian  
7 company; right?  
8 **A To my knowledge, yes.**  
9 Q To your knowledge?  
10 **A Yes.**  
11 Q And the -- The Beretta AR-70 was not based on  
12 Eugene Stoner's original AR-15 design by ArmaLite?  
13 **A I couldn't speak to the design intent of the**  
14 **manufacturers, but I would presume no.**  
15 Q What is AR and AR-70 mean?  
16 **A I do not recall that.**  
17 Q Is the AR-70 still in production, to your  
18 knowledge?  
19 **A Not for civilian consumption and not for**  
20 **military consumption, to my knowledge.**  
21 Q All right. I'm going to direct your attention  
22 back to the ISP guide. So that's Deposition Exhibit 10.  
23 Bottom of page 28 where it says Beretta AR-70 with flash  
24 suppressor. Do you see that?  
25 **A Yes.**

Page 75

1 Q Do you agree that the Beretta AR-70 has a  
2 pistol grip?  
3 **A I do.**  
4 Q Do you agree that the Beretta AR-70 is -- Is  
5 there a semi-automatic version of the Beretta AR-70?  
6 **A I am sure that there are some automatic**  
7 **conversions that have been done on that, but for general**  
8 **consumption, it was not produced for the civilian market.**  
9 Q So it was not produced for the civilian market  
10 and was, in fact, an automatic firearm?  
11 **A Correct. Which would be banned by Illinois**  
12 **law and federal law.**  
13 Q And that automatic ban predates PICA; right?  
14 **A Yes.**  
15 Q Would you agree that the AR-70 can accept a  
16 detachable magazine?  
17 **A I do.**  
18 Q Does the AR-70 depicted at page 28 of  
19 Exhibit 8 have a flash suppressor?  
20 **A It appears to.**  
21 Q And that's one of the prohibitive  
22 characteristics under the PICA definition; is that right?  
23 **A It is.**  
24 Q Would you agree that, even if this rifle had  
25 not been listed under AR-type, it has multiple features

Page 76

1 listed in PICA under subsection 1.9 (a)(1)(A)?  
2 **A It does, in similar manner to other rifles.**  
3 Q And you also mentioned that most of the AR-70s  
4 produced were fully automatic firearms; right?  
5 **A Right.**  
6 Q Directing your attention to paragraph 23 of  
7 your declaration. So we're going back to Exhibit 2. In  
8 there, you wrote, "There is no such gun as the Rock River  
9 Arms AR-47, but if that is intended to refer to the LAR-47,  
10 again, there are substantial differences, including  
11 caliber, magazine used and general appearance."  
12 That was your testimony?  
13 **A Yes.**  
14 Q Would you agree that the LAR-47 is an AK-47  
15 type rifle?  
16 **A I would not.**  
17 Q How would you characterize the LAR-47?  
18 **A I would characterize it as a derivative of the**  
19 **AR-15, designed to take AR-47 style magazines.**  
20 Q When you say it's a derivative of the AR-15,  
21 what do you mean?  
22 **A I mean that it was inspired by, takes design**  
23 **elements from, but is not -- is not the same firearm.**  
24 Q Why not?  
25 **A It uses different magazines, uses different**



Page 77

1 **calibers, different receiver styles.**

2 Q You said that the LAR-47 takes the AR-15 and

3 changes the caliber, the magazine, and changes it in a way

4 that's towards like AK-47 caliber?

5 **A Correct.**

6 Q Do you think the LAR-47 could be characterized

7 as an AK-type firearm?

8 **A I don't.**

9 Q Why not?

10 **A Because it's not an AK-type firearm based on**

11 **the Kalashnikov design.**

12 Q Would you agree that the LAR-47 takes design

13 elements from both the AK-47 and the AR-15?

14 **A I would.**

15 Q So would you characterize the LAR-47 as a bit

16 of a hybrid between an AK-47 and the AR-15?

17 **A That's reasonable, yes.**

18 Q I'm going to direct your attention to an

19 exhibit that I'm going to mark as Exhibit 11.

20 (Deposition Exh bit No. 11 marked for

21 identification.)

22 Q (By Mr. Wells) Do you recognize this document?

23 **A I have not seen it before today, but I**

24 **recognize it as Rock River Arms' website.**

25 Q So I can represent to you it's a screen shot

Page 78

1 of Rock River Arms' website specifically relating to the

2 LAR-47?

3 **A Yes.**

4 Q Do you see the URL listed up there that says

5 RockRiverArms.com?

6 **A I do.**

7 Q Do you agree that the firearm depicted in

8 Deposition Exhibit 11 is an LAR-47?

9 **A I would agree.**

10 Q Do you agree that this is a semi-automatic

11 rifle?

12 **A It appears to be, yes.**

13 Q Do you agree that the rifle depicted in

14 Deposition Exhibit 11 has a detachable magazine?

15 **A It does.**

16 Q And do you agree that the rifle depicted in

17 Deposition Exhibit 11 has a pistol grip?

18 **A It does.**

19 Q Do you agree that the rifle depicted in

20 Deposition Exhibit 11 has a flash suppressor?

21 **A It appears to have a compensator, not a flash**

22 **suppressor.**

23 Q What's the difference between a compensator

24 and a flash suppressor?

25 **A A compensator's made to mitigate recoil felt**

Page 79

1 **by the shooter. A flash oppressor is designed to mitigate**

2 **flash seen by the shooter.**

3 Q Do you agree that the LAR-47 has a barrel

4 shroud as depicted in Deposition Exh bit 11?

5 **A Again, I would consider that a hand guard**

6 **meant to prevent the user from burning themselves while**

7 **shooting. A barrel shroud, other than PICA, to my**

8 **knowledge, doesn't have a solid definition.**

9 Q Do you agree that the rifle depicted in

10 Deposition Exhibit 11 has a telescoping or adjustable

11 stock?

12 **A It appears to.**

13 Q Would you agree that the rifle depicted in

14 Deposition Exhibit 11 would qualify as an assault weapon

15 under the features-based definition in PICA?

16 **A Yes.**

17 Q I'm going to direct your attention back to the

18 ISP guide, so Deposition Exhibit 10. Directing your

19 attention to page 39, do you see where it says Anderson

20 AM-15 BR?

21 **A I do.**

22 Q And that's listed under other, quote, AR-type,

23 close quote, rifles as defined by the Protecting Illinois

24 Communities Act. Do you see that?

25 **A I do.**

Page 80

1 Q Would you agree that the Anderson AM-15 BR is

2 an AR-type rifle?

3 **A Yes. AR-15 type rifle.**

4 Q Directing your attention to the next rifle

5 underneath that, next to Ruger AR 556 MPR with M-Lok rail.

6 Do you recognize the firearm depicted immediately to the

7 right of that language as a Ruger AR-50 -- 56 MPR?

8 **A I do.**

9 Q Would you agree that that's an AR-type rifle?

10 **A That's an AR-15 type rifle, yes.**

11 Q And in the Ruger name, Ruger AR-556, what do

12 you understand the 556 to refer to?

13 **A The typical caliber that it is sold in. So**

14 **5.56 NATO.**

15 Q And even though Ruger is calling it a Ruger

16 AR-556, you still recognize it to be an AR-15 type rifle?

17 **A I do.**

18 Q Directing your attention to the next firearm

19 depicted next to the language "Springfield Armory SAINT

20 Victor." Do you see that?

21 **A I do.**

22 Q Do you agree that that's an AR-type rifle?

23 **A AR-15 type, yes.**

24 Q Directing your attention to the next firearm

25 depicted on page 39 next to Radical Firearms, RF-15 SOCOM.

Page 81

1 Do you recognize that rifle?  
2 **A I do.**  
3 Q Do you recognize it as a Radical Firearms  
4 RF-15 SOCOM?  
5 **A Radical Firearms is a wide product variety,**  
6 **product offering in many variants, but it looks like one of**  
7 **their firearm styles, yes.**  
8 Q Would you agree that the firearm depicted at  
9 the bottom of page 39 next to Radical Firearms is an AR-15?  
10 **A It appears to be, yes.**  
11 Q Would you at call it an AR-type rifle?  
12 **A I would call it an AR-15 type rifle, yes.**  
13 Q I want you to look through pages 40 through  
14 42. And after you've had a chance to look at those, I want  
15 you to tell me whether the rifles depicted on those pages  
16 are all AR-15 type rifles.  
17 **A They appear to be.**  
18 Q So you would agree with me that the rifles  
19 depicted on pages 39 to 42 of Deposition Exh bit 10, the  
20 Illinois State Police Assault Weapons Identification Guide,  
21 all of those rifles depicted are AR-15 type rifles;  
22 correct?  
23 **A Yes.**  
24 Q And all of those rifles are AR-type rifles;  
25 right?

Page 82

1 **A Of the Stoner design, yes.**  
2 Q All right. One more on ARs and then --  
3 **A Okay.**  
4 Q We're not done yet.  
5 **A Sure.**  
6 Q If you need a break, too, by the way, just let  
7 me know.  
8 (Deposition Exhibit No. 12 marked for  
9 identification.)  
10 Q (By Mr. Wells) I'm going to show you what I'm  
11 marking as Deposition Exhibit 12.  
12 MR. MAAG: Thank you.  
13 Q (By Mr. Wells) You mentioned earlier that you  
14 have been to Pew Pew Tactical's website; is that right?  
15 **A Yes.**  
16 Q I can represent to you that these are screen  
17 shots from Pew Pew Tactical's website. Let me direct your  
18 attention to the second page. Do you see where it says,  
19 "The Modern AR-15?"  
20 **A I do.**  
21 Q Do you see underneath that it says, "It used  
22 to be really easy. Head down to your local gun shop and  
23 choose from the two or three ARs they have on the shelf,  
24 but those days are long gone. Now you're bombarded with  
25 too many choices."

Page 83

1 Do you understand what's meant here by ARs?  
2 **A I do. AR-15s.**  
3 Q Do you agree with what this -- these couple of  
4 sentences say?  
5 **A Yes.**  
6 Q And how do you understand what's being  
7 described here?  
8 **A This -- That there are many variants of the**  
9 **AR-15 that are produced under different names by different**  
10 **manufacturers, but are substantially similar.**  
11 Q And did it always -- Has it always been the  
12 case that there are a lot of AR-15 manufacturers?  
13 **A From my time in firearms, yes. However, I**  
14 **was -- My time in firearms began after the sunset of the**  
15 **Clinton assault weapons ban.**  
16 Q So there was a period of time when most gun  
17 shops would carry two or three AR-type rifles; is that  
18 right?  
19 **A Correct. Twenty-plus years ago.**  
20 Q How many different types of AR-rifles do you  
21 carry at Piasa Armory?  
22 **A As many as are manufactured and supplied by**  
23 **our distributors.**  
24 Q Do you have any idea of the number of  
25 manufacturers of AR-15s that you offer at Piasa?

Page 84

1 **A I would assume in the neighborhood of 50.**  
2 Q Okay. Why don't we take a short break.  
3 **A Sure.**  
4 THE VIDEOGRAPHER: This is the videographer.  
5 We are going off the record. The time now is 3:42.  
6 (Whereupon, a short break was taken.)  
7 THE VIDEOGRAPHER: This is the videographer.  
8 We are back on the record. The time now is 3:49.  
9 Q (By Mr. Wells) Mr. Pulaski, I'd like to direct  
10 your attention back to your May 18th declaration,  
11 paragraph 26. In paragraph --  
12 MR. MAAG: Which paragraph?  
13 MR. WELLS: Twenty-six.  
14 Q (By Mr. Wells) In paragraph 26, you wrote,  
15 "Likewise, there are no objective standards to determine  
16 whether a given firearm is an AK-type, an AR-type or  
17 something else. In fact, even the listed examples are  
18 oftentimes not within the parameters of what even most  
19 firearms experts would consider to be an AK-type like the  
20 SKS or an AR-type."  
21 I switched that "of" to an "or" because it was  
22 a typo; right?  
23 **A Correct.**  
24 Q You do believe there are parameters for what  
25 most firearms experts would consider an AK-type; correct?

Page 85

1 **A I do.**

2 Q In your mind, what are the parameters that

3 most firearms experts would consider to be an AK-type?

4 **A Those would be of the design of the original**

5 **AK-47 designed by Kalashnikov. So basically, a civilian**

6 **semi-automatic variant of the military fully automatic**

7 **AK-47.**

8 Q What does AK stand for?

9 **A Automatic Kalashnikov.**

10 Q What language is that?

11 **A Russian.**

12 Q What does the Avtomat mean?

13 **A Automatic.**

14 Q And what does Kalashnikov mean?

15 **A Rifle designed by Kalashnikov, basically.**

16 Q And who is Kalashnikov?

17 **A Kalashnikov was a Russian military tanker,**

18 **while injured, designed the AK-47 in competition with the**

19 **SKS designer.**

20 Q Who was the SKS designer?

21 **A Simonov.**

22 Q Where was Simonov from?

23 **A Also from Russia.**

24 Q You said that Kalashnikov and Simonov were in

25 competition from -- with one another. What do you mean by

Page 86

1 that?

2 **A They were designing rifles at the same time,**

3 **or similar time, attempting to have their designs adopted**

4 **by the Russian military as a whole.**

5 Q What does the AK -- What does the 47 refer to

6 in AK-47?

7 **A The year that the design was adopted.**

8 Q I'm directing your attention to paragraph 13

9 of your May declaration. In paragraph 13, you wrote, "As

10 to the named firearms in the Illinois ban, as I previously

11 stated, I'm familiar with both the AK or Soviet Avtomat."

12 MR. MAAG: Avtomat.

13 Q (By Mr. Wells) You meant Avtomat there; is

14 that right?

15 MR. MAAG: Well, Avtomat is how it's

16 pronounced.

17 Q (By Mr. Wells) But it's spelled A-V-T-O.

18 **A In the English translation.**

19 Q Is that right?

20 **A Yes.**

21 Q Or Soviet Avto Kalashnikov?

22 MR. MAAG: Kalashnikov.

23 Q (By Mr. Wells) You meant to write Kalashnikov?

24 **A Missing the S in there. Yes.**

25 Q Series of rifles, which is a 1947 Soviet

Page 87

1 design select fire shoulder-fired weapon that under federal

2 law would be a machine gun.

3 So the original AK-47 would be a machine gun

4 under federal law because it's fully automatic?

5 **A And select fire, yes.**

6 Q You agree there is such a thing as the AK

7 series of rifles; correct?

8 **A There is an entire collection in family of**

9 **firearms based on the AK-47 design.**

10 Q Would you agree that the AK-47 is one of the

11 most famous weapons in the world?

12 **A It is.**

13 Q And there have been many, tens of millions, of

14 AK-47s produced?

15 **A Produced, yes. But as far as imported into**

16 **this country, not nearly that many.**

17 Q So I'm going to read you a statement, and I

18 want you to let me know if you agree with it.

19 "After more than seven decades since its

20 creation, the AK-47 model and its variants remain one of

21 the most popular and widely used firearms in the world."

22 Do you agree with that?

23 **A Yes.**

24 Q You mentioned earlier, I believe, you own an

25 AK-47?

Page 88

1 **A I own a Romanian WASR-10.**

2 Q But you consider the Romanian WASR-10 to be an

3 AK-47?

4 **A To somebody who doesn't have experience with**

5 **firearms, they would say it was an AK variant. However,**

6 **it's an AKM, which is similar to the AR-15 versus the M-16.**

7 **It's cosmetically similar, but different.**

8 Q What does AKM stand for?

9 **A I do not recall the M at this time.**

10 Q What do the AK in AKM stand for?

11 **A Typically, it stands for Avtomat Kalashnikov.**

12 Q Same thing as -- Same meaning as an AK-47; is

13 that right?

14 **A Correct.**

15 Q What is an AK-74?

16 **A AK-74 is a modern redesign of the AK-47, which**

17 **is part of the AK family. It uses different ammunition.**

18 Q You say different ammunition. What do you

19 mean?

20 **A The standard AK-47 uses 762 by 39. The AK-74**

21 **uses 545 by 39. It's a Soviet attempt to have a similar**

22 **military round to the United States.**

23 Q In the name AK-74, what does the AK?

24 **A Avtomat Kalashnikov.**

25 Q What does 74 mean in AK 74?



Page 89

1 **A That would be the year that it was adopted for**  
2 **wide use in the military.**  
3 Q And was Kalashnikov the same person who  
4 designed the AK-47 also the person who designed the AK-74?  
5 **A I don't recall, but I presume that it was.**  
6 Q What is an AK-56?  
7 **A I don't recall.**  
8 Q Do you know what a type 56 rifle is?  
9 **A I'd say a Chinese variant of the Kalashnikov**  
10 **design.**  
11 Q When you say variant, what do you mean?  
12 **A The Chinese are famous for copying designs of**  
13 **Russian firearms, vehicles, any other equipment, and making**  
14 **them for their military with changes that are suitable for**  
15 **their military.**  
16 Q I'm going to direct your attention back to  
17 Section 1.9 --  
18 **A Okay.**  
19 Q -- of PICA provisions. So Deposition  
20 Exhibit 9. We're going to go to page two, capital J,  
21 little I.  
22 **A Uh-huh (yes).**  
23 Q Where it says, "All AK types." Do you see  
24 that?  
25 **A Yes.**

Page 90

1 Q And then under the little I, there is Roman  
2 numerals one through six. Do you see that?  
3 **A Yes.**  
4 Q And under Roman numeral one, there are several  
5 numbers and letters listed. I want you to look at Roman --  
6 capital Roman numeral one through six, and tell me which of  
7 the firearms listed here you don't think -- or you -- Let  
8 me strike that and start over.  
9 I want you to look at J little I Roman  
10 numerals one through six and tell me which of the firearms  
11 listed here you believe are not properly characterized as  
12 AK-types.  
13 **A Anything that is not a traditional AK-47,**  
14 **AK-74 or the other Russian military variant would not be an**  
15 **AK-type. It would be an AKM variant, typically, for the**  
16 **civilian market.**  
17 Q So give me the specific model numbers here  
18 that are listed that you think are not properly  
19 characterized as A -- AK-types.  
20 **A Sure. So things like the MAK-90, the MISR,**  
21 **NHM90, NHM91, SA-93, the Vector, VEPR, WASR-10, the Maadi,**  
22 **and Norinco items, and the SKS.**  
23 Q So of these models, how many of these did you  
24 identify in your declaration of -- the two declarations  
25 that you prepared in this case?

Page 91

1 **A I don't recall. Specifically, the SKS and --**  
2 **but the AK variant was not a focus necessarily as much as**  
3 **the SKS was.**  
4 Q What has changed between when you prepared  
5 your two sworn statements and today where now you're adding  
6 additional firearms that you didn't identify in your  
7 declaration that you don't believe are properly  
8 characterized as AK-types?  
9 **A The AK-types are not -- I'm thinking of how to**  
10 **phrase this properly. Sorry.**  
11 **Again, it's similar to AR -- AR-15s and**  
12 **M-16's, the AK-types, the -- the original manufactured**  
13 **design for Kalashnikov, the military variant, is what's**  
14 **typically referred to as the AK or the AK-47, but those**  
15 **variants are similar. But civilian market variants, the**  
16 **AR-15 versus the M-16.**  
17 Q So are the ones that you identified, like the  
18 MAK90, are those -- is that available in the civilian  
19 market in the United States?  
20 **A Not in this state anymore. The AK-90 was**  
21 **available minorly, but not widely in just one of the many**  
22 **variants was out there.**  
23 Q What does MAK stand for and MAK90?  
24 **A I don't recall.**  
25 Q Does the AK stand for Avtomat Kalashnikov?

Page 92

1 **A One could presume that.**  
2 Q And you said it wasn't a big presence here in  
3 the United States or something like that. What did you  
4 mean?  
5 **A Typically, items like the WASR-10, which were**  
6 **brought over in kit form and produced by a major**  
7 **manufacturer, were the prevalent variant of the AK-47, copy**  
8 **of the AK-47.**  
9 Q So the WASR-10, you would agree, is a copy of  
10 the AK-47?  
11 **A It's a civilian legal copy, yes.**  
12 Q And just so I understand, the distinction  
13 you're making is that the AK-47 is an automatic weapon  
14 and --  
15 **A Correct.**  
16 Q Is that correct?  
17 **A Correct.**  
18 Q And some of these are semi-automatic weapons?  
19 **A Anything but the AK-47 and AK-74 in the**  
20 **civilian market are civilian weapons.**  
21 Q Do you think that a -- I like a Palmetto State  
22 Armory AK-47 variant that's semi-automatic is properly  
23 characterized as an AK-47?  
24 **A It's not a machine gun as the original AK-47**  
25 **was. So it's a derivative, yes, but it's not a variant.**

Page 93

1 Q So you would only use the term AK-47 to apply  
2 to fully automatic firearms?  
3 **A In definitional terms, yes. But in jargon,  
4 not necessarily.**  
5 Q So out there in the world, if you have  
6 customers who come into Piasa Armory and they say I want an  
7 AK-47, do you -- do you show them semi-automatic AK-47s?  
8 **A We show them some variant of the AK that's  
9 civilian legal, like the WASR-10, or direct them to  
10 Palmetto State Armory for their PAS AK-47.**  
11 Q So a customer who would use AK-47 in that  
12 context who would refer to a semi-automatic, you would  
13 understand what they meant?  
14 **A I would, yes.**  
15 Q The NHM-90, why is that -- why do you consider  
16 that to be something other than an AK-type firearm?  
17 **A Because it's not an AK-47.**  
18 Q Why not?  
19 **A That's not a -- not a Russian military issued  
20 AK-model 47.**  
21 Q What is it?  
22 **A That's -- I -- I'm sorry. I don't recall what  
23 that specific one is manufactured -- who it's manufactured  
24 by. But it's just one of the other many civilian legal  
25 varieties, copies of the AK-47.**

Page 94

1 Q So you would agree that NHM-90 is a civilian  
2 legal variant of the AK-47?  
3 **A A copy, yes. Not a -- Not a variant  
4 necessarily, but a derivative of.**  
5 Q Would you also agree that the MAK-90 is a  
6 civilian legal variant of the AK-47?  
7 **A Possibly.**  
8 Q Is that a yes?  
9 **A Yes.**  
10 Q Is the SA-85 a civilian legal variant of the  
11 AK-47?  
12 **A It could be.**  
13 Q Is that a yes?  
14 **A Yes.**  
15 Q Is the SA-93 a civilian legal variant of the  
16 AK-47?  
17 **A A copy, yes.**  
18 Q The VEPR. Is the VEPR a civilian legal  
19 variant of the AK-47?  
20 **A A similar, yes.**  
21 Q And we mentioned the WASR-10. You agree that  
22 that is a civilian legal variant of the AK-47?  
23 **A Correct.**  
24 Q How about the Maadi AK-47, what is that?  
25 **A The Maadi is an Egyptian copy of the AK-47,**

Page 95

**1 and several parts kits were imported and converted to  
2 civilian use to not -- no longer be automatic and legal  
3 with federal law.**  
4 Q Can civilians outside of Illinois and  
5 elsewhere in the United States acquire Maadi AK-47s in  
6 semi-automatic form?  
7 **A I believe they can.**  
8 Q What is a Norinco 56S?  
9 **A A Norinco is a Chinese manufacturer that made  
10 copies of the AK-47. The Norinco models that came to the  
11 United States were semi-automatic.**  
12 Q And you say came to the United States, are  
13 they still coming to the United States?  
14 **A No.**  
15 Q When did that stop?  
16 **A To my knowledge, that was in the '90s, during  
17 the changes to federal import laws.**  
18 Q So of today, you're not aware of any Norinco  
19 56Ss being legally imported into the United States?  
20 **A To my knowledge, no.**  
21 Q And would that also apply to the 56S2?  
22 **A Any Norinco product, to my knowledge.**  
23 Q And it would also apply to the 84S?  
24 **A Correct.**  
25 Q And the 86S from Norinco?

Page 96

**1 A Correct.**  
2 Q Why do you think the SKS is not properly  
3 characterized as an AK-type?  
4 **A Because it's an SKS and not an AK.**  
5 Q What's different about the two firearms?  
6 **A The entire operating system is different. The  
7 AK uses a single piston. The SKS uses multiple. SKS uses  
8 internal magazines, where the AK-47 uses detachable  
9 magazines.**  
10 Q Does the SKS use the same caliber of  
11 ammunition as the AK-47?  
12 **A It does.**  
13 Q And does the SKS, was it created in the same  
14 country as the AK-47?  
15 **A Yes.**  
16 Q And what country was that?  
17 **A Russia or the Soviet Union.**  
18 Q All right. I'm going to direct your attention  
19 back to the ISP guide. Directing your attention to  
20 Deposition Exhibit 10, pages 25 to 26.  
21 Do you see at the top of page 25, it says,  
22 "Other AK-type rifles as designed -- as defined by the  
23 Protecting Illinois Communities Act."  
24 Do you see that?  
25 **A Yes.**

Page 97

1 Q And the top of the page there, page 25, it  
2 says, "Palmetto State Armory -- Armory, PS AK-47 GF3."  
3 Do you see that?  
4 **A Yes.**  
5 Q You mentioned earlier that if a customer came  
6 in asking for an AK-47, you might direct them to Palmetto  
7 State Armory; is that right?  
8 **A Correct.**  
9 Q And is this one of the types of AK models that  
10 you would direct them to?  
11 **A Yes.**  
12 Q And is that because the PS AK-47 GF3 is a  
13 semi-automatic civilian version of the AK-47?  
14 **A That's a civilian copy of it, yes.**  
15 Q And looking at the PS AK-47 GF3 at the top of  
16 page 25, as far as you can tell, it's a semi-automatic  
17 rifle?  
18 **A It appears to be.**  
19 Q And it has a detachable magazine?  
20 **A It does.**  
21 Q Does it also have a pistol grip?  
22 **A It does.**  
23 Q Does it have a flash suppressor?  
24 **A It does not.**  
25 Q Does it have an adjustable stock?

Page 98

1 **A This does not appear to be.**  
2 Q But you would agree that the PS AK-47 GF3 is  
3 properly called an AK-type firearm?  
4 **A I would call it a copy of the AK firearm.**  
5 Q Direct your attention to the next firearm down  
6 the page, so the second from the top. The Century Arms VS  
7 KA. Do you agree that that's an AK-type firearm?  
8 **A It's a -- again, a civilian copy of the AK.**  
9 Q As far as you can tell, is it a semi-automatic  
10 rifle?  
11 **A It appears to be.**  
12 Q Does it have a detachable magazine?  
13 **A It does.**  
14 Q Does it have a pistol grip?  
15 **A It does.**  
16 Q Moving down to the Kalashnikov USAKR 103. Do  
17 you see that?  
18 **A I do.**  
19 Q Would you disagree that the Kalashnikov USAKR  
20 103 is an AK-type firearm?  
21 **A It's a copy of them, yes.**  
22 Q All right. I'd like you look at pages 25 and  
23 26. And I would like you to tell me if there are any  
24 firearms depicted here that you would not consider an  
25 AK-type firearm?

Page 99

1 **A I would consider these to be copies of the**  
2 **AK-type firearms with -- some with modernized features and**  
3 **not holding true to the original design of the AK-47.**  
4 Q You would at least agree that all the firearms  
5 depicted on pages 25 to 26 of Deposition Exhibit 10 are  
6 copies of the AK in some degree?  
7 **A Some variance or derivative of.**  
8 Q That's a yes?  
9 **A Yes.**  
10 Q You can set that to the side for a second.  
11 (Deposition Exh bit No. 13 marked for  
12 identification.)  
13 Q (By Mr. Wells) I'm handing you what's been  
14 marked as Deposition Exhibit 13, which I can represent to  
15 you is a printout of information from Palmetto State  
16 Armory's website, and specifically, the web page relating  
17 to the PS AK 47 G5 Forge classic rifle. Do you see that?  
18 **A I do.**  
19 Q Do you recognize the firearm depicted on  
20 page one of Deposition Exhibit 13?  
21 **A This particular one, no, but the overall**  
22 **design of Palmetto State Armory's AK pattern, AK style**  
23 **derivative rifles, yes.**  
24 Q Are you familiar with something called an AKP  
25 from Palmetto State Armory?

Page 100

1 **A I believe that refers to their AK-47 variant**  
2 **pistols.**  
3 Q What is an AK-47 variant pistol?  
4 **A Those are firearms that were designed as a**  
5 **handgun without a stock or with shorter barrels.**  
6 Q What makes the AKP from Palmetto State Armory  
7 an AK-47 variant pistol?  
8 **A The fact that it has no stock, was designed as**  
9 **a handgun from the start, was not built from a rifle or a**  
10 **full-size firearm, and has that shorter barrel on it.**  
11 Q And those are the reasons why it would be  
12 classified as a pistol; right?  
13 **A Correct.**  
14 Q What are the reasons why the AKP from Palmetto  
15 State Armory would be characterized as an AK?  
16 **A Because it's the -- shares all of the same**  
17 **characteristics as their PS AK-47 rifle, other than legal**  
18 **requirements.**  
19 Q So other characteristics would include things  
20 like the same caliber as AK-47?  
21 **A Correct.**  
22 Q What else?  
23 **A Same operating system, same magazines, similar**  
24 **pistol grips, trigger, and hammer -- fire control groups.**  
25 Q All right. Let's go back -- I diverted us,



Page 101

1 but back to Exh bit 13. I'm going to direct your attention  
2 to page three. The text in the middle of the page, the  
3 kind of last text before --  
4 **A Yes.**  
5 Q -- it stops.  
6 Do you see where it says, "As we are  
7 transitioning to Soviet arms, your receivers may be stamped  
8 with our new AK Soviet arms logo on firearms manufactured  
9 after March 8th, 2023. This will not affect the quality or  
10 function of the firearm as they are the same AK receivers  
11 used for our AKs."  
12 You understand what Palmetto State Armory is  
13 saying here when it says AKs; right?  
14 **A I do. That's their model name.**  
15 Q And their model name refers to civilian  
16 variants of the AK-47?  
17 **A Civilian copies, yes.**  
18 Q I keep saying variants, you keep saying  
19 copies. Why -- why are you correcting --  
20 **A A variant would be something like the AK-74 or**  
21 **something that would be a light machine gun variant of the**  
22 **traditional AK-47s. Something like a longer barrel where**  
23 **it would take a drum or a belt magazine or belt feeding**  
24 **device, something that might be a precision rifle variant**  
25 **of it. In the same way that a Toyota Camry has a variety**

Page 102

1 **of model options, those are variants of that same base**  
2 **model.**  
3 Q So, in your mind, copy is actually closer to  
4 the original?  
5 **A Not necessarily. Copies can be -- They may**  
6 **make changes that are functionally or cosmetically**  
7 **different to modernize. Or like -- I believe this one was**  
8 **trying to be as close to a classic AK-style, the wood**  
9 **furniture that's on the gun, that kind of darker color**  
10 **that's out there. So it's just trying to be a copy of the**  
11 **original but still be within the rules, regulations,**  
12 **civilian legal, but not necessarily a variant of the same**  
13 **gun.**  
14 Q The look and feel of the original AK-47; is  
15 that fair?  
16 **A Match the style, yes.**  
17 Q And capability; right? Aside from the  
18 automatic capability and the, you know, select fire  
19 capability, other than that, roughly the same?  
20 **A Functionally in single fire, one shot at a**  
21 **time, semi-automatic mode, yes, they'd be very similar,**  
22 **yes. And I believe that last paragraph on page three**  
23 **refers to a branding change, not a manufacturer change.**  
24 Q All right. Let's just look at the same  
25 exhibit, page seven.

Page 103

1 MR. MAAG: Of?  
2 MR. WELLS: The same exhibit, Deposition  
3 Exh bit 13.  
4 Q (By Mr. Wells) So do you understand what you  
5 see here to be comments from visitors to the website  
6 commenting on the Palmetto State Armory or PSA AK-47 GF 5?  
7 **A Yes.**  
8 Q Under another PSA winner, do you see where it  
9 says, "My first AK, and it is a beauty?" Do you see that?  
10 **A I do.**  
11 Q And do you understand what AK means in that  
12 sentence?  
13 **A As a member of the industry, yes. I can also**  
14 **see from this that person's very new to the industry and**  
15 **firearms as a whole it appears.**  
16 Q Do -- do you believe -- In your experience at  
17 Piasa Armory, do customers use the phrase AK as a reference  
18 to civilian versions of the AK-47?  
19 **A In general, our customer base tends to shorten**  
20 **terms. So somebody may refer to an AK but mean an AK-47**  
21 **copy or an AK-74 copy or a 12-gauge copy of the AK,**  
22 **referring to the Saiga shotguns or any other similar**  
23 **shotguns of that same cosmetically similar design.**  
24 Q All right. Let's see. You mentioned that you  
25 sometimes go to AR-15.com; is that right?

Page 104

1 **A I do.**  
2 Q And you sometimes review the -- what people  
3 have posted there; is that right?  
4 **A I do.**  
5 (Deposition Exh bit No. 14 marked for  
6 identification.)  
7 Q (By Mr. Wells) I'm marking Deposition  
8 Exhibit 14. Do you recognize this?  
9 **A I recognize this as AR-15.com, yes.**  
10 Q So these are screen shots from AR-15.com. You  
11 can see the URLs at the top. And on the first page of  
12 Deposition Exhibit 14, do you recognize this as the -- the  
13 main page of AR-15.com?  
14 **A It appears to be.**  
15 Q And do you see where it says discussion forums  
16 and there's a drop down menu?  
17 **A I do.**  
18 Q And one of the discussion forums listed is  
19 AK-47. Do you see that?  
20 **A I do.**  
21 Q And in your experience going to AR-15.com, do  
22 folks come to AR-15.com to participate in the discussion  
23 forums to talk about AK-47s?  
24 **A I would presume that they do. I tend to focus**  
25 **more on the AR-15 side of the AR-15.com forums.**

Page 105

1 Q So if you were looking to answer a specific  
2 question, as you said you sometimes do with AR-15.com,  
3 about AKs and you came to this website, and you went to the  
4 AK-47 forums, you would click on that discussion forum  
5 where it says AK-47; is that fair to say?  
6 **A If I was looking for information on copies of  
7 the AK, yes.**  
8 Q So I'd like to direct your attention to the  
9 last page of the exhibit.  
10 **A Okay.**  
11 Q And looking at the URL at the top, can you  
12 tell that this is from AR-15.com?  
13 **A Yes.**  
14 Q And it's specifically the AK-47 page from  
15 AR-15.com?  
16 **A Yes.**  
17 Q And here it says new AK products. Do you see  
18 that?  
19 **A I do.**  
20 Q You understand what that means; right?  
21 **A I do, yes.**  
22 Q And AK discussions is the next topic. Do you  
23 see that?  
24 **A Yes.**  
25 Q You understand what that means?

Page 106

1 **A That appears to be discussions about anything  
2 relevant to AK platform, copies, variants.**  
3 Q And -- and following that row over, do you see  
4 it says topics 5,600 and -- I'm sorry, 56,970. Do you see  
5 that?  
6 **A I do.**  
7 Q So would you agree that, at least as of the  
8 time of this screen shot, there were apparently 56,970  
9 topics under the AK discussions label?  
10 **A I would.**  
11 Q Do you see where it says, replies right under  
12 topics?  
13 **A I do.**  
14 Q And it says 632,806?  
15 **A Yes.**  
16 Q So is -- Based on that, there appeared to have  
17 been 632,806 comments grouped under AK discussions; is that  
18 fair?  
19 **A Yes.**  
20 Q So based on that, do you think the average  
21 person coming to AR-15.com to go to a discussion forum on  
22 the AK would understand that AK discussions is a reference  
23 to AK-47 type firearms?  
24 **A That would be reasonable, yes.**  
25 Q Okay. Let's see. Let's talk about

Page 107

1 interchangeability. Direct your attention to your May 19  
2 declaration, paragraph eight. This is Deposition  
3 Exhibit 2.  
4 In paragraph eight, you wrote "That is it." I  
5 assume you meant "that it is"; right?  
6 **A Yes.**  
7 Q "So that it is objectively impos sible to  
8 determine whether a given magazine, feed strip, or other  
9 ammunition feeding device is for a rifle, shotgun, handgun  
10 or something else simply by looking at the device."  
11 Is that your testimony?  
12 **A Correct.**  
13 Q Your concern is that if I handed you a  
14 magazine by itself, and you had no other information to go  
15 on other than looking at the magazine, you could not say  
16 whether the magazine was for a handgun or a rifle; is that  
17 right?  
18 **A It depends on the magazine, but possibly, yes.**  
19 Q And that's the concern you're identifying in  
20 paragraph eight?  
21 **A Correct.**  
22 Q If you were handed a magazine with no other  
23 information, by looking at the magazine, are there things  
24 that you could tell about that particular magazine?  
25 **A I could assume that the caliber and make a**

Page 108

1 **presumption of what model it was originally intended for.  
2 However, many firearms share the same magazines both in  
3 pistol and rifle variants.**  
4 Q So you would be able to look at a magazine  
5 and -- and tell the caliber?  
6 **A Potentially. But there are many calibers that  
7 are very similar, and it's not a -- a guarantee for many --  
8 a specific firearm or magazine.**  
9 Q Is it fair to say that you would be able to  
10 look at a magazine that was just handed to you with no  
11 other information and have a rough sense of what cal ber  
12 would be used in that magazine?  
13 **A Potentially, but again, it depends on the  
14 particular magazine.**  
15 Q Do you agree that not all magazines can be  
16 used in all firearms?  
17 **A Yes.**  
18 Q For example, you can't use a Beretta M-92  
19 9-millimeter magazine in a 5.56 NATO caliber AR-15;  
20 correct?  
21 **A In an AR-15 chambered for 5.56, no. But you  
22 can use a Beretta .92 magazine in an AR-15 that is  
23 chambered for 9-millimeter.**  
24 Q Right. But you'd have to know what cal ber of  
25 ammunition you're going to use in that AR-15; right?

Page 109

1 **A You would.**  
2 Q If you had a 5.56 NATO AR-15 and you attempted  
3 to use 9-millimeter ammunition in it, what would happen?  
4 **A Well, the firearm may not function, and if it**  
5 **did, it could cause damage or injury.**  
6 Q What kind of damage or injury?  
7 **A The -- Well, when a -- when a bullet is shot,**  
8 **it produces explosive gas, flame that -- and pressure. And**  
9 **if that were to not be contained in the chamber of the**  
10 **firearm, which wouldn't be possible with 9-millimeter going**  
11 **into a 223 or 556 firearm, then that would go into the path**  
12 **of least resistance.**  
13 Q For two firearms to be able to use the same  
14 magazine, the firearms at least have to use the same  
15 caliber of ammunition; is that fair to say?  
16 **A No.**  
17 Q Is it fair to say that the two firearms, if  
18 they're going to use the same magazine, have to share at  
19 least one common caliber of ammunition that they use?  
20 **A Not necessarily. Example again is the 556,**  
21 **223 and the 50 Beowulf, 458 SOCOM, 223, a 30-round magazine**  
22 **only accommodates nine to 10 rounds of 50 Beowulf or 58**  
23 **SOCOM.**  
24 Q So you're talking about the magazine. I'm  
25 asking about the firearm.

Page 110

1 **A Okay.**  
2 Q So in order for one firearm chambered in a  
3 specific caliber to have a magazine that can be used in  
4 another firearm chambered in a caliber, there has to be at  
5 least one common caliber between those two firearms;  
6 correct? For the magazine to function?  
7 **A Well, if both fire -- I'm sorry. I guess I'm**  
8 **not understanding clarity-wise. But if you have an AR-15**  
9 **that is chambered in 223 and an AR-15 that we chambered in**  
10 **50 Beowulf or 58 SOCOM, those don't share the same caliber,**  
11 **of course, but they do share the same magazine.**  
12 **And cosmetically, the magazine is no different**  
13 **between the same firearms. You could use all of the**  
14 **ammunition -- load that magazine with 223 or 556, fire it**  
15 **in that firearm that was chambered for 223 or 556. Use the**  
16 **same exact magazine, load it with 50 Beowulf, 458 SOCOM,**  
17 **the appropriate caliber for that second firearm, and then**  
18 **fire with that same magazine with that lower capacity.**  
19 Q The weapons that you just described, are all  
20 of those weapons assault weapons under PICA?  
21 **A Potentially, but not necessarily.**  
22 Q And you're talking about calibers and  
23 ammunition that can be used in magazines that will fit in  
24 rifles that can take large caliber ammunition, like the  
25 Beowulf, for instance; right?

Page 111

1 **A Correct.**  
2 Q So in that example, neither one of those  
3 firearms, if you had a Beretta M-92 9-millimeter, you  
4 couldn't use it in those firearms you just -- you just  
5 described, you couldn't use that magazine?  
6 **A Correct.**  
7 Q Do you agree that there's some calibers that  
8 are more commonly used in rifles than in handguns?  
9 **A Yes. However, that doesn't necessarily mean**  
10 **that a caliber is exclusively for a handgun or a rifle.**  
11 **For example, a 9-millimeter is a very common caliber in**  
12 **rifles and in handguns. .22 caliber, similar.**  
13 Q 6.5 Grendel, is that more common as a rifle or  
14 handgun ammunition?  
15 **A We've seen both as -- from our customer base.**  
16 **A bolt pistol handgun variant AR-15, copy AR-15s, and rifle**  
17 **copy AR-15s.**  
18 Q Which would you say is more prevalent, rifles  
19 that use 6.5 Grendel or handguns that use 6.5 Grendel?  
20 **A In this particular area, handguns, just based**  
21 **on our geography and lack of available areas to use those**  
22 **firearms.**  
23 Q What about a 338 Lapua? Are you familiar with  
24 any handgun that uses 338 Lapua ammunition?  
25 **A I believe that a company has produced**

Page 112

1 **something that would be considered a handgun without a**  
2 **stock with a shorter barrel and only pistol grip.**  
3 Q What kind of Walther again?  
4 **A It is a PPQ Q5 match.**  
5 Q In your experience, is Walther a good firearm?  
6 **A A reputable brand and quality manufacturer,**  
7 **yes.**  
8 Q And you, as a firearms expert or someone who  
9 just knows a lot about firearms, in terms of picking a  
10 firearm that you're going to carry around with you to  
11 defend yourself, you're going to choose carefully; right?  
12 **A Yes.**  
13 Q So the fact that you chose a Walther is an  
14 affirmation in your mind that Walther is a quality brand;  
15 right?  
16 **A In my mind, yes.**  
17 Q I'm going to hand you --  
18 **A Sixteen.**  
19 Q -- what I'm going to mark as Deposition  
20 Exhibit 16.  
21 (Deposition Exhibit No. 16 marked for  
22 identification.)  
23 Q (By Mr. Wells) Looking at Deposition  
24 Exhibit 16, do you see the URL there at the top?  
25 **A I do.**



Page 113

1 Q Do you see that the URL says  
2 Waltherarms.com/PDP?  
3 **A I do.**  
4 Q And I can represent to you that this is screen  
5 shots from the Walther Arms page specifically about the  
6 PDP?  
7 **A Yes.**  
8 Q And are you familiar with the PDP by Walther?  
9 **A I am.**  
10 Q What is it?  
11 **A It is a modern semi-automatic handgun, polymer  
12 based, striker fired with detachable magazines.**  
13 Q Do you see on the front of Exhibit 16 Walther  
14 PDP was apparently awarded the guns and ammo 2021 handgun  
15 of the year?  
16 **A Yes.**  
17 Q Do you think that was a well-deserved award?  
18 **A I -- Based on Walther's history and quality, I  
19 would, yes.**  
20 Q All right. Let me direct your attention to  
21 the back of that page. So it's a double-sided copy.  
22 **A Yeah.**  
23 Q Do you see that there are three handguns  
24 depicted here --  
25 **A I do.**

Page 114

1 Q -- on page two of this exhibit? The handgun  
2 depicted on the left, it's called a PDP compact. Do you  
3 see that?  
4 **A I do.**  
5 Q And under magazine capacity, what -- what's --  
6 what's listed?  
7 **A It lists 15 rounds.**  
8 Q What does that mean?  
9 **A That means that the magazine that's included  
10 with that firearm, that particular item number, is a  
11 15-round.**  
12 Q And looking down further, do you see at the  
13 bottom it says 10-round item number? The same column.  
14 **A I do.**  
15 Q What do you understand 10-round item number to  
16 mean?  
17 **A That to be 10-round magazine capacity variant.**  
18 Q So looking at the Walther website, is it fair  
19 to say that a person interested in purchasing a PDP compact  
20 could purchase either a PDP compact with a factory magazine  
21 of 15 rounds or a factory magazine of 10 rounds?  
22 **A Yes.**  
23 Q And directing your attention to the next  
24 firearm in the middle, PDP full size. Do you see that?  
25 **A I do.**

Page 115

1 Q What is the magazine capacity for the PDP full  
2 size?  
3 **A Eighteen rounds.**  
4 Q And the magazine there for the PDP of -- PDP  
5 full size of 18 rounds, that's above the 15-round threshold  
6 for PICA; right?  
7 **A It is.**  
8 Q So that magazine is not one that you could  
9 sell consistent with PICA?  
10 **A Correct.**  
11 Q But if a customer at Piasa Armory wanted a PDP  
12 full size, you could direct them to the 10-round item;  
13 right?  
14 **A We could.**  
15 Q And the 10-round magazine would comply with  
16 PICA?  
17 **A It would.**  
18 Q Just looking at the last page of this exhibit.  
19 Walther sells 10-round magazines for the PDP; right?  
20 **A For the full side and the compact, yes.**  
21 Q All right.  
22 (Deposition Exhibit No. 17 marked for  
23 identification.)  
24 Q (By Mr. Wells) This is No. 17. We talked  
25 about the Shooter's Bible earlier. Do you recall that?

Page 116

1 **A I do.**  
2 Q So I am marking as Deposition Exhibit 17 --  
3 MR. MAAG: Oh, I see how it is.  
4 Q (By Mr. Wells) I'm marking as Deposition  
5 Exhibit 17 an excerpt of the Shooter's Bible 114th Edition.  
6 I have a complete copy of it, but I'm -- I've just given  
7 you excerpts, which are copied pages from this complete  
8 version.  
9 **A Yes.**  
10 Q And you mentioned earlier that you keep copies  
11 of the Shooter's Bible for reference at Piasa Armory; is  
12 that right?  
13 **A Typically, yes.**  
14 Q So this 114th Edition, according to the  
15 copyright, is from 2022. And I'm going to direct your  
16 attention to page 153, directing your attention to the  
17 bottom of the page, Heckler & Koch.  
18 Do you see three rifles laid out there that  
19 are Heckler & Koch rifles?  
20 **A I do.**  
21 Q Are you familiar with the Heckler & Koch  
22 MR762A1?  
23 **A I am.**  
24 Q And the Heckler & Koch MR762A1 is a rifle;  
25 correct?

Page 117

1 **A It is.**  
2 Q And a rifle is a long gun?  
3 **A It's typically referred to as, yes.**  
4 Q And do you see on page 153 here, under  
5 magazine, it says, detachable box, 10 rounds, 20 rounds, do  
6 you see that?  
7 **A Yes.**  
8 Q So I want you to imagine you had a customer  
9 who owned a version of this rifle, so the Heckler & Koch  
10 MR762A1, that they purchased before January 10th of 2023,  
11 so before PICA took effect.  
12 **A Okay.**  
13 Q And this customer needs a replacement magazine  
14 for that rifle, for the MR762A1. Between the 10-round  
15 magazine and the 20-round magazine, which of those  
16 magazines can you sell to that customer?  
17 **A We would be required to only sell the 10-round**  
18 **magazine.**  
19 Q All right. I'm going to direct your attention  
20 to -- and -- I'm sorry. Before I leave that page,  
21 page 153, do you see on the -- the right-hand side how it  
22 has rifles there?  
23 **A I do.**  
24 Q And is it fair to say that the Shooter's Bible  
25 groups firearms into categories like rifle, handgun and

Page 118

1 shotgun?  
2 **A Yes.**  
3 Q And that's because those are -- rifle, handgun  
4 and shotgun are pretty common types of firearms?  
5 **A Those are industry terms for the -- the**  
6 **variety of things that are offered from various**  
7 **manufacturers, yes.**  
8 Q I'm going to direct your attention to page 363  
9 of this exhibit. I'm directing your attention to the upper  
10 left-hand corner of the SP5. Do you see that?  
11 **A I do.**  
12 Q Do you see for the SP5, next to capacity, it  
13 says 10, 15, 30 rounds? Do you see that?  
14 **A I do.**  
15 Q Do you agree that the Heckler & Koch SP5 is a  
16 handgun?  
17 **A This variant of the SP5 is, yes.**  
18 Q So I want you to imagine, again, a customer  
19 who owns a Heckler & Koch SP5 that they acquired prior to  
20 January 10, 2023, when PICA took effect. They need to  
21 replace the magazine for the Heckler & Koch SP5. Which  
22 capacity magazine can you legally see to that customer?  
23 **A They would typically purchase that with a**  
24 **30-round magazine. We would be limited to selling them the**  
25 **10 or 15-round magazine.**

Page 119

1 Q When you're buying a magazine for a specific  
2 handgun, it is possible to know how many rounds of  
3 ammunition of a particular caliber that magazine will hold?  
4 **A It's possible to know how -- how many it was**  
5 **designed to hold, but designed does not always line up with**  
6 **how many it will actually hold. Magazines that begin to**  
7 **wear or were not designed properly can sometimes hold more**  
8 **or sometimes hold less, or errors in manufacturing can make**  
9 **them hold more or less.**  
10 Q But generally speaking, what the manufacturer  
11 represents about the capacity of the magazine is what the  
12 magazine capacity is?  
13 **A Magazines from reputable manufacturers, yes.**  
14 Q And when you're buying a magazine for a  
15 specific handgun, it is possible to buy a magazine of 15  
16 rounds or less as long as the handgun manufacturer offers  
17 such a magazine for that handgun; correct?  
18 **A If the customer would like to purchase a**  
19 **factory brand magazine, yes. But again, not every company**  
20 **produces factory magazines of 15 or -- of 15 rounds for**  
21 **guns that are not designed for 15-round magazines.**  
22 Q And when you're buying a magazine for a  
23 specific rifle, it is possible to know how many rounds of  
24 ammunition of a particular caliber that magazine will hold?  
25 **A Based on what the manufacturer of the magazine**

Page 120

1 **says. But again, other magazines can hold other calibers.**  
2 Q So there may be some variation, but generally  
3 speaking, what the manufacturer represents about the  
4 magazine capacity for a particular rifle is going to be the  
5 magazine capacity?  
6 **A It depends on the rifle and the manufacturer.**  
7 Q If it's a reputable manufacturer?  
8 **A It can be, but magazines like AR-15 magazines**  
9 **can be produced by reputable manufacturers but hold 30 of**  
10 **one round and five or 10 of another round.**  
11 Q And in the examples you just gave of a  
12 magazine that can hold 30 of one round and five or 10 of  
13 another round, the five or 10 of another round would be a  
14 much larger caliber; right?  
15 **A Typically.**  
16 Q So when someone buys an AR-15, let's say it  
17 has a 15-round -- or let's say it has a 10-round magazine.  
18 All right? So an AR-15, 10-round magazine, it may be a  
19 10-round magazine for 5.56 NATO; is that right?  
20 **A Correct.**  
21 Q But that same magazine for a larger caliber  
22 may hold fewer than 10 rounds; correct?  
23 **A Correct.**  
24 Q If -- If that same magazine is designed for an  
25 AR-15 that's chambered in 5.56 NATO, and the magazine

Page 121

1 capacity is 10 rounds, can the magazine accept more than 10  
 2 rounds of a different caliber of ammunition?  
 3 **A It depends on the overall size of the**  
 4 **magazine. For example, Magpul is the industry -- industry**  
 5 **standard for AR-15 magazines has a magazine that is**  
 6 **designed for 10 rounds only, but shares the same form**  
 7 **factor as the 30-round magazine.**  
 8 Q When you say form factor, what do you mean?  
 9 **A The outside appearance.**  
 10 Q And what is different about the inside of that  
 11 magazine?  
 12 **A The inside has either a block or is built with**  
 13 **denial spaces to prevent that large capacity.**  
 14 Q Why -- Do you have an understanding as to why  
 15 Magpul did that?  
 16 **A They sold a lot to customers in California and**  
 17 **other states with 10-round magazine capacity limits who**  
 18 **wanted to use other equipment standard to the AR-15**  
 19 **industry, things like magazine pouches and magazine**  
 20 **couplers, but still retain that form factor of a 30-round**  
 21 **magazine.**  
 22 Q So it's your understanding that Magpul  
 23 recognized that there was a 10-round magazine limit  
 24 applicable in California, and they designed the inside of  
 25 the magazine that could be used for a 30-round AR-15 such

Page 122

1 that that magazine could only accept 10 rounds; is that  
 2 right?  
 3 **A Correct. They also sell limiting items. So**  
 4 **something you could take the magazine apart, insert into**  
 5 **the magazine to prevent additional rounds from going into**  
 6 **it.**  
 7 Q And if someone needed to replace AR-15  
 8 magazines in Illinois, could the manufacturer do the same  
 9 thing in Illinois for a 10-round limit?  
 10 **A Potentially, but that would be up to the**  
 11 **manufacturer and business decisions.**  
 12 Q And if a manufacturer did offer such a  
 13 magazine, you would be able to sell it under PICA; right?  
 14 **A We would.**  
 15 MR. WELLS: Can we take a quick break real  
 16 quick?  
 17 THE VIDEOGRAPHER: This is the videographer.  
 18 We're going off the record. The time now is 4:56.  
 19 (Whereupon, a short break was taken.)  
 20 THE VIDEOGRAPHER: This is the videographer.  
 21 We're back on the record. The time now is 5:03.  
 22 Q (By Mr. Wells) Mr. Pulaski, we previously  
 23 looked at the two sworn written statements that you  
 24 prepared in this case as Deposition Exhibits 1 and 2. Do  
 25 you remember that?

Page 123

1 **A Yes.**  
 2 Q In preparing those declarations, did you get  
 3 any information from Mr. Maag that you included in those  
 4 declarations?  
 5 **A Yes.**  
 6 Q What information specifically?  
 7 **A I didn't keep a list of specific information,**  
 8 **but this was a discussion back and forth through the**  
 9 **entire -- through the entirety of both of these**  
 10 **declarations.**  
 11 Q And is information from an attorney in a  
 12 lawsuit the type of information that firearms experts  
 13 typically rely on?  
 14 **A That depends on the attorney. This particular**  
 15 **attorney happens to also be a firearms expert with much**  
 16 **deeper encyclopedic-level knowledge than I have. He's**  
 17 **guided me toward a lot -- a lot more places to broaden my**  
 18 **knowledge.**  
 19 Q We talked earlier about AR-type rifles. Does  
 20 AR -- if -- If you use the term "AR-type," would that  
 21 sometimes fairly include both the AR-15 and the AR-10?  
 22 **A In a layman's term, yes, but -- So somebody**  
 23 **with lack of knowledge of the industry, lack of firearms**  
 24 **knowledge. Just in the same way that anyone says car, they**  
 25 **look at any car and say that's a car. But somebody that**

Page 124

1 **has more knowledge says, yes, that's a Toyota or a Honda.**  
 2 **Similar ways -- analogous to differences between the AR-10**  
 3 **and the AR-15.**  
 4 MR. WELLS: So subject to my reservation  
 5 rights earlier on about the scope of this deposition, my  
 6 motion for summary judgment, and reserving the right to  
 7 potentially seek a second deposition, to the extent  
 8 necessary, related to the other claims that aren't covered  
 9 by the summary judgment motion, I don't have any further  
 10 questions for you at this time.  
 11 **THE WITNESS: Okay.**  
 12 MR. MAAG: Like the last time, it would be  
 13 quicker if we changed sides.  
 14 MR. WELLS: Sure.  
 15 MR. MAAG: We can go off while we're changing  
 16 sides.  
 17 THE VIDEOGRAPHER: This is the videographer.  
 18 We're going off the record. The time now is 5:05.  
 19 (Whereupon, a short break was taken.)  
 20 THE VIDEOGRAPHER: This is the videographer.  
 21 We're back on the record. The time now is 5:07.  
 22 **EXAMINATION**  
 23 **QUESTIONS BY MR. MAAG:**  
 24 Q I'm handing you a magazine. Are there any  
 25 markings on that?



Page 125

1 MR. WELLS: Tom, I'm just going to note,  
2 again, my objection that I had before which is --  
3 MR. MAAG: Same objection that you put on the  
4 record before, you can have a standing objection.  
5 MR. WELLS: Right, but it's another -- it's  
6 another witness, so I just want to be clear. These are  
7 items that prior to today I personally had not seen. They  
8 were not produced to us. I under -- understand your  
9 position on that, but I just want to note my objection to  
10 the use of these particular items in this deposition as  
11 well.  
12 MR. MAAG: All right. And for the record, I  
13 didn't see all of your documents prior to today either, but  
14 you're -- you're on the record.  
15 MR. WELLS: Right. And you didn't serve any  
16 written discovery requests on us; right?  
17 Q (By Mr. Maag) All right. You ready?  
18 **A Go ahead.**  
19 Q Generally, what is that that I've handed you?  
20 **A That's a magazine that is made in Brazil, and**  
21 **it says 15 on the back of it.**  
22 Q All right. Is there any serial number or  
23 model marking on that?  
24 **A There is not.**  
25 Q Do you recognize that, what that fits?

Page 126

1 **A It would fit, based on a notch in the back of**  
2 **it, an older Beretta style pistol or rifle that takes older**  
3 **style Beretta magazines.**  
4 Q Okay. Is that a rifle magazine? Pistol  
5 magazine? Or are you able to discern the difference?  
6 **A Because it can fit both, I can't discern**  
7 **whether it's one or the other.**  
8 Q Okay. I'm handing you another magazine. Are  
9 there any markings on that?  
10 **A I see none.**  
11 Q Do you recognize that magazine?  
12 **A This looks like a magazine from a Mini-14**  
13 **or -- I'm sorry, a M-14 or similar variant.**  
14 Q I'm handing you a third magazine. Do you  
15 recognize that magazine?  
16 **A That one is definitely a magazine of M-14 or**  
17 **similar, M1A.**  
18 Q All right. The first -- Or the second  
19 magazine that you previously thought might have been an  
20 M-14 variant, do you still think that's an M-14 variant?  
21 **A No.**  
22 Q All right. Let's go back to the second  
23 magazine. Are you able to discern what that magazine is  
24 actually for now?  
25 **A No.**

Page 127

1 Q All right. Are you able to discern whether  
2 that's a rifle, pistol or shotgun magazine?  
3 **A I can presume that it is not a shotgun**  
4 **magazine. However, there are shotgun rounds that could fit**  
5 **in this magazine.**  
6 Q Are you able to discern whether that's a rifle  
7 or pistol magazine?  
8 **A No.**  
9 Q Set that aside and go to what you have  
10 identified as an M-14 magazine. You -- Are there any  
11 markings on that?  
12 **A No.**  
13 Q You simply recognize that magazine?  
14 **A I do.**  
15 Q All right. Is there any functional difference  
16 for that -- for a rifle versus a pistol?  
17 **A No. They're all a box with a spring inside.**  
18 Q Okay. I'll hand you another magazine. Do you  
19 recognize that magazine?  
20 **A It looks like something that was designed to**  
21 **fit an AR-10 or similar model.**  
22 Q All right. Are there any markings on it?  
23 **A There are not.**  
24 Q All right. If I were to represent to you that  
25 that is a French Model 1949 magazine, would that help you

Page 128

1 in any way, shape or form?  
2 **A Yes.**  
3 Q All right. Are you able to discern from your  
4 observations whether that's a rifle or pistol magazine?  
5 **A If I were to know that this was a French M-49**  
6 **magazine, I would know that it was for the M-49. However,**  
7 **those can be converted into pistols as well.**  
8 Q I'm handing you a magazine. Do you recognize  
9 that magazine?  
10 **A I do.**  
11 Q What is that?  
12 **A This is for an M-1 carbine.**  
13 Q All right. And do you know about how many  
14 rounds -- assuming that's a standard magazine for an M-1  
15 carbine of that size, how many rounds that should hold?  
16 **A It appears it should be 15.**  
17 Q All right. And the M-1 carbine, is that a  
18 rifle, pistol or shotgun?  
19 **A It is either a rifle or a pistol.**  
20 **Traditionally, for the military, it was a rifle. However,**  
21 **they were modified to become pistols and are currently**  
22 **produced as pistols also.**  
23 Q And who currently produces them as pistols?  
24 **A Inland Manufacturing.**  
25 Q All right. Did anyone else previously

Page 129

1 manufacture them as pistols?  
2 **A I'm sure that they have.**  
3 Q Okay. So that magazine could fit either a  
4 rifle or a pistol?  
5 **A Yes.**  
6 Q All right. Could you legally sell that in  
7 Illinois?  
8 **A If it were for a pistol, yes. If it were for**  
9 **a rifle, no.**  
10 Q If a customer came in and said I have an M-1  
11 carbine, can you order me a 15-round magazine for it, do  
12 you have enough information to determine whether or not you  
13 could legally sell that magazine?  
14 **A No.**  
15 Q If they told you that it was for a pistol,  
16 could you legally order and sell that magazine?  
17 **A If it was for a 15 -- If it was 15 rounds for**  
18 **a pistol, yes.**  
19 Q What if that person owned both an M-1 carbine  
20 pistol and an M-1 rifle?  
21 **A I would have no way of discerning that from**  
22 **interaction at the counter.**  
23 Q All right.  
24 **A But it would presume that they would not be**  
25 **allowed to use that in their rifle if they bought a**

Page 130

1 **15-round magazine.**  
2 Q All right.  
3 **A Thank you.**  
4 Q Are there any markings on that magazine?  
5 **A It says "checkmate" on the bottom.**  
6 Q All right. Do you recognize that magazine?  
7 **A I recognize it, and it says 45 ACP on the**  
8 **side. I recognize the basic design.**  
9 Q What is the basic design?  
10 **A That is for pistols that are of the 1911 style**  
11 **or a variety of conversions that were rifle variants.**  
12 Q All right. What is the 1911 style?  
13 **A 1911 is the U.S. military pistol adopted in**  
14 **1911. It was standard until the late '70s, early '80s.**  
15 Q Okay. Are there rifles that use that  
16 magazine?  
17 **A Yes.**  
18 Q Are there pistols that use that magazine?  
19 **A Yes.**  
20 Q I'm handing you -- Well, what am I handing  
21 you?  
22 **A This is a frame for a 1911.**  
23 Q Is that magazine compatible with that?  
24 **A It is.**  
25 Q Can you insert it?

Page 131

1 **A I can.**  
2 Q Does it fit?  
3 **A It does. It doesn't lock because there's --**  
4 **the parts aren't there.**  
5 Q Right. It's nonfunctional because it's  
6 disassembled and missing most of the parts; correct?  
7 **A Right.**  
8 Q All right. Is there -- Assuming that that  
9 pistol was complete, does that appear that that magazine  
10 would function in that frame?  
11 **A Yes.**  
12 Q All right. And that frame is normally in a  
13 pistol configuration?  
14 **A We've seen and sold them in both**  
15 **configurations, pistol and rifle.**  
16 Q All right. What am I handing you now?  
17 **A This is a pistol stock.**  
18 Q And if you could attach that. Assuming that  
19 that was complete with a barrel, that same frame would now  
20 be what?  
21 **A It would be considered a short-barreled rifle.**  
22 Q It'd be a rifle?  
23 **A Yes.**  
24 Q All right. With the same magazine?  
25 **A With the same magazine.**

Page 132

1 Q So mechanically, there is no difference  
2 between that magazine as a rifle magazine and that magazine  
3 as a pistol magazine; correct?  
4 **A Correct.**  
5 Q All right. I'm handing you another magazine.  
6 Are there any markings on that?  
7 **A There are some numbers on the back of it.**  
8 Q What are the numbers?  
9 **A It's A15981.**  
10 Q All right. Do you recognize that magazine?  
11 **A It appears to be a 308 or 76239 variant of a**  
12 **AK potentially. No, I take that back. No, I do not**  
13 **recognize this magazine. It's missing a part of the front.**  
14 Q All right. Well, it's actually complete,  
15 but --  
16 **A Sorry. Complete for -- for the magazine, but**  
17 **not complete for what I thought it was.**  
18 Q All right. Are you able to discern whether  
19 that is a rifle or a pistol or a shotgun magazine?  
20 **A No.**  
21 Q All right. Let's see. Handing you another  
22 magazine. Are there any markings on that?  
23 **A There is Walther markings on it.**  
24 Q What does it say specifically, if you can read  
25 it?

Page 133

1 **A It says Walther P-1 9-millimeter.**  
 2 Q Okay. Is that a rifle or a pistol magazine?  
 3 **A Unknown, but --**  
 4 Q Were there both rifle and pistol variants of  
 5 the Walther P-1?  
 6 **A Yes.**  
 7 Q In fact, did Ronald Reagan have a Walther P-1  
 8 carbine?  
 9 MR. WELLS: Objection. Lack of personal  
 10 knowledge.  
 11 MR. MAAG: It's on display at his presidential  
 12 museum.  
 13 MR. WELLS: That's my objection.  
 14 Q (By Mr. Maag) You can answer.  
 15 **A I have no personal knowledge of it.**  
 16 Q All right. Then that's fine. What's that  
 17 magazine?  
 18 **A That looks like an older European magazine.**  
 19 Q Are there any markings on it?  
 20 **A There are none.**  
 21 Q Maybe on the base?  
 22 **A It looks like a couple numbers. 66-4 or 4-99.**  
 23 Q Are you able to discern whether that's a rifle  
 24 or a pistol magazine?  
 25 **A No.**

Page 134

1 Q All right. Handing you another magazine. Are  
 2 there any markings on that?  
 3 **A There are.**  
 4 Q What are the markings?  
 5 **A It says M-88, M-100, 308 cal, 243 cal.**  
 6 Q Are there any other markings on it?  
 7 **A It says Colyer clip on the side.**  
 8 Q All right. Are you able to discern whether  
 9 that's a rifle, pistol or shotgun magazine?  
 10 **A No.**  
 11 Q And I'll hand you another magazine. Are there  
 12 any markings on that?  
 13 **A This one is marked FN Manufactured, Inc,  
 14 Columbia, South Carolina, and a manufacturer code.**  
 15 Q All right. Are you able to discern whether  
 16 that's a rifle, pistol or shotgun magazine?  
 17 **A No.**  
 18 Q Is it possible that that magazine will fit  
 19 both rifles, pistols or shotguns?  
 20 **A Yes.**  
 21 Q What type of magazine did I hand you there?  
 22 **A This is a Glock magazine.**  
 23 Q All right. And is it similar to this other  
 24 magazine that I gave you?  
 25 **A Yes. This other one is a Magpul brand, Glock**

Page 135

1 **compatible magazine.**  
 2 Q All right. And I'm handing you a frame. What  
 3 is that frame of, generally?  
 4 **A This is a Glock.**  
 5 Q All right. Do those magazines generally fit  
 6 in that pistol frame?  
 7 **A Of this design, yes.**  
 8 Q All right. And that would be a pistol frame  
 9 then?  
 10 **A Typically, but can also be a rifle.**  
 11 Q All right. I'm handing you a shoulder stock.  
 12 Does that attach to that pistol frame?  
 13 **A Yes, it does.**  
 14 Q Go ahead and attach it. Would then that make  
 15 that a rifle?  
 16 **A If it were complete, yes.**  
 17 Q With the same magazine?  
 18 **A Correct.**  
 19 Q Is it fair to say there's no discernible  
 20 difference -- no discernible difference that you can  
 21 articulate or you can identify between a rifle magazine and  
 22 a pistol magazine?  
 23 MR. WELLS: Objection to form.  
 24 Q (By Mr. Maag) You can answer.  
 25 **A Between these magazines, no.**

Page 136

1 Q The magazines that I have handed to you for  
 2 examination, other than one -- other than the Glock and  
 3 Magpul branded magazine for Glocks, are they the -- do they  
 4 appear to be for the same firearms?  
 5 **A Yes. These two particular magazines.**  
 6 Q Okay. The Glock and the Magpul are?  
 7 **A Yes.**  
 8 Q The other magazines, any of them, are they the  
 9 same as any of the other magazines that I have handed you?  
 10 **A They don't appear to be.**  
 11 Q All right. So it's a wide variety of  
 12 magazines?  
 13 **A Yes.**  
 14 Q Okay. Do you recognize that?  
 15 **A This appears to be the bolt and carrier from a  
 16 Saiga shotgun or similar variant or copy.**  
 17 Q All right. Is that an AK-47 type?  
 18 **A It's a copy of the AK-47 of a 12-gauge variant  
 19 of the AK-47.**  
 20 Q All right. And can you describe that for the  
 21 record? What does it look like?  
 22 **A It is a rotating bolt inside of a large  
 23 metallic housing with a handle on the side and a piston on  
 24 the front.**  
 25 Q All right. Is that what an AK-47 rifle or



Page 137

1 pistol bolt and gas piston would look like other than the  
 2 sizes?  
 3 MR. WELLS: Objection to form.  
 4 Q (By Mr. Maag) You can answer.  
 5 **A It's made -- It's modified to accept the**  
 6 **proper ammunition.**  
 7 Q I understand there's dimensional differences,  
 8 but I mean, the general description.  
 9 **A Yes.**  
 10 Q All right. Is that the same -- Are you  
 11 familiar with the gas and bolt system of the M1 Garand?  
 12 **A Yes.**  
 13 Q Is that the same general gas and bolt system  
 14 of the M1 Garand?  
 15 **A Yes. The Garand uses a rotating bolt and a**  
 16 **long piston.**  
 17 Q Is it fair to say that other than dimensional  
 18 differences, there is no difference between the gas and  
 19 bolt system of a Garand and an AK-47 type firearm?  
 20 MR. WELLS: Objection to form.  
 21 Q (By Ms. Helfrich) You can answer.  
 22 **A Very similar.**  
 23 Q You were asked to read part of PICA. Do you  
 24 remember that?  
 25 **A I do.**

Page 138

1 Q I believe it's Exhibit 9 that was given to  
 2 you?  
 3 **A Yes.**  
 4 Q And there was a features definition that I  
 5 think you were asked to read at one point; correct?  
 6 **A Yes.**  
 7 Q Did that include a semi-automatic firearm that  
 8 could accept a detachable magazine and had a pistol grip?  
 9 **A Yes.**  
 10 Q Are you familiar with that -- what I have  
 11 handed you?  
 12 **A I am.**  
 13 Q What is that, generally?  
 14 **A In general, it's an M1 carbine rifle stock.**  
 15 Q Does it appear to be a standard M1 carbine  
 16 rifle stock?  
 17 **A It does.**  
 18 Q The grip on that, what would you call that  
 19 type of grip?  
 20 **A The industry refers to it as a pistol grip.**  
 21 Q Is that the same type of grip as on an AK-47  
 22 or an AR-15?  
 23 **A It's a similar shape and style.**  
 24 Q But it doesn't protrude below, does it?  
 25 **A Below the bottom of the stock, no.**

Page 139

1 Q Okay. And the -- Does part of that stock on  
 2 the front of it, if it was fully assembled, would that  
 3 cover the barrel?  
 4 **A It would.**  
 5 Q And would that allow the non-firing hand to  
 6 prevent the firer from burning themselves while holding the  
 7 firearm with the non-firing hand?  
 8 **A It would.**  
 9 Q And is the M1 carbine a semi-automatic  
 10 firearm?  
 11 **A Yes.**  
 12 Q Does it accept a detachable magazine?  
 13 **A It does.**  
 14 Q Therefore, is it fair to say in its original  
 15 configuration, the M1 carbine is prohibited under PICA?  
 16 MR. WELLS: Objection. Calls for a legal  
 17 conclusion.  
 18 Q (By Mr. Maag) You can answer.  
 19 **A Based on my experience and reading PICA, it**  
 20 **does.**  
 21 Q Is the M1 carbine in any way, shape or form an  
 22 AR-type or AK-type firearm?  
 23 **A It is not.**  
 24 Q If AK-47s or AR-15 type firearms were  
 25 converted to bolt action or pump action, under PICA could

Page 140

1 they be sold in Illinois?  
 2 MR. WELLS: Objection. Calls for a legal  
 3 conclusion.  
 4 Q (By Mr. Maag) You can answer.  
 5 **A Because of the definitions of PICA and machine**  
 6 **gun parts -- Or pardon me. Definition of PICA and assault**  
 7 **weapon parts, that lower receiver on an AR-15 is considered**  
 8 **an assault weapon or an assault weapon part.**  
 9 Q Who says?  
 10 **A PICA.**  
 11 Q And has the state police posted commentary to  
 12 that effect on their website?  
 13 **A I believe in the questions and answers page**  
 14 **they got that.**  
 15 Q So it is fair to say that a bolt-action rifle,  
 16 based on the commentary of the state police on their  
 17 website, that look too much like an AR-15 would be  
 18 prohibited under PICA?  
 19 **A Yes.**  
 20 Q The same question --  
 21 MR. WELLS: Where is that coming from?  
 22 MR. MAAG: Off your client's website.  
 23 MR. WELLS: And do you have a copy of what  
 24 you're talking about?  
 25 MR. MAAG: It's on your client's website.

Page 141

1 MR. WELLS: Have you produced a copy of --  
2 MR. MAAG: Of your client's website? No, it's  
3 on your website.  
4 Q (By Mr. Maag) Same question for the AK-47.  
5 **A It would be the same answer as an AR-15.**  
6 MR. MAAG: I didn't write your client's  
7 website.  
8 MR. WELLS: It's kind of hard to know what  
9 you're talking about when I don't have something to look  
10 at, Tom. That's my objection.  
11 MR. MAAG: Okay. Well, maybe your client will  
12 take it down after you talk to them.  
13 Q (By Ms. Helfrich) You have Exhibit No. 17 in  
14 front of you?  
15 **A I do.**  
16 Q That's the Shooter's Bible cover page?  
17 **A Yes.**  
18 Q Are those firearms legal to sell in the State  
19 of Illinois?  
20 **A Not all of them.**  
21 Q Why not?  
22 **A The pistol pictured at the bottom has a**  
23 **threaded barrel and was banned by PICA.**  
24 Q Are you familiar with the Beretta AR-100?  
25 **A Yes.**

Page 142

1 Q Is that an AR-type firearm?  
2 **A Let me find the page, please.**  
3 Q Not asking if it's listed.  
4 **A I'm sorry. No, it's not. It just shares a**  
5 **basic shape.**  
6 Q Are you familiar with the Mauser c96 broom  
7 handle with fixed 20-round magazine?  
8 **A I am.**  
9 Q What vintage is that?  
10 **A Pre 1900s.**  
11 Q That's literally designed and made in the  
12 1800s?  
13 **A Yes.**  
14 Q And is that listed on Exh bit No. 10, page 12,  
15 as being illegal in Illinois under PICA?  
16 **A Yes.**  
17 Q You were asked about the Norinco 86S. Are you  
18 familiar with that particular firearm?  
19 **A Not having handled it a lot, but with the**  
20 **basic idea of it, yes.**  
21 Q And Exhibit No. 10, page 23, there's a  
22 photograph of it?  
23 **A Yes.**  
24 Q And is that what you recognize as a Norinco  
25 86S?

Page 143

1 **A Yes.**  
2 Q Does that look like an AK-type firearm?  
3 **A It does not based on the overall shape of it,**  
4 **no.**  
5 Q If someone were to show that to you -- Strike  
6 that.  
7 If someone were to say you can't have an  
8 AK-type firearm in Illinois, and you were asked about the  
9 Norinco 86S, visually would you think that that is an  
10 AK-type firearm?  
11 **A Only if I had intimate knowledge of the**  
12 **AK-style firearms.**  
13 Q And on page 24 of Document 10, at the bottom  
14 there's reference to SKS with detachable magazine. Are  
15 there any parts commonalities that you're aware of between  
16 the SKS, either with or without a detachable magazine, and  
17 anything that is arguably an AK variant or copy?  
18 **A The only part that would be potentially**  
19 **interchangeable would be a sling in a magazine, depending**  
20 **on the detachable magazine conversion kit used.**  
21 Q If someone were to tell you that you could not  
22 sell or possess an AK-type firearm in the State of Illinois  
23 and then you were shown an SKS, would that trigger you in  
24 your mind that you could not have that SKS?  
25 **A That would -- Well, no. The short answer, no.**

Page 144

1 Q On page 28 of Exhibit 10.  
2 MR. WELLS: Sorry. I'm just trying to help.  
3 MR. MAAG: That's okay. I'll wait for you.  
4 MR. WELLS: Actually, you know, what, they are  
5 right here. I'm sorry. Here we go.  
6 Q (By Mr. Maag) Page 28. You were asked about  
7 the ArmaLite M15 .22 LR carbine?  
8 **A Yes.**  
9 Q Does that even have a gas system?  
10 **A No.**  
11 Q The gas system on a standard AR-15 is designed  
12 by Gene Stoner when he was at ArmaLite back in the '50s,  
13 does that have a gas system?  
14 **A The ArmaLite AR-15, yes.**  
15 Q All right. We ta ked about the Beretta AR-70,  
16 the Bushmaster ACR. Is that in any way, shape or form an  
17 AR variant?  
18 **A No.**  
19 Q Why not?  
20 **A It was designed from the ground up apart from**  
21 **an AR-15.**  
22 Q All right. Is the gas system the same?  
23 **A No. It uses a piston instead of direct gas.**  
24 Q Is the stock the same?  
25 **A No.**

Page 145

1 Q The AR-15, does it have a detachable pistol  
2 grip?

3 A **The AR-15 does.**

4 Q Does the Bushmaster ACR have a detachable  
5 pistol grip?

6 A **It does not.**

7 Q Page 30, the Chiappa Firearm M4 rifles. Kind  
8 of looks like a US M4 carbine?

9 A **Yes.**

10 Q Does it have a gas system?

11 A **It doesn't appear to.**

12 Q Is it in any way, shape or form an AR-type  
13 firearm as you understand it?

14 A **Since they are type of a firearm with gas  
15 systems, no.**

16 Q Page 32, the Heckler & Koch MR 556. Does that  
17 have any direct gas impingement system like an AR-15?

18 A **It uses a piston.**

19 Q We ta ked about that already. We talked about  
20 that. The Ruger AR 556, does that have a gas impingement  
21 or gas piston?

22 A **AR 556 has a impingement gas.**

23 Q Does Ruger make a gas piston version?

24 A **I do. It's called the SR 556.**

25 Q All right. So the Ruger SR 556 would be

Page 146

1 different than an AR-15 as designed by Gene Stoner because  
2 it has a gas system and not a gas impingement system?

3 A **Yes.**

4 MR. WELLS: What page are you on, Tom?

5 MR. MAAG: I'm not even looking at anything.  
6 I'm just --

7 MR. WELLS: Riffing.

8 Q (By Mr. Maag) I'm trying to skip over stuff  
9 you have already ta ked about because I don't want to be  
10 here any more than you do. The Beretta cX 4 on page 43.

11 A **Yes.**

12 Q Does that take the same magazine as the  
13 Beretta .92 pistol?

14 A **Yes.**

15 Q Is that a rifle?

16 A **It is.**

17 Q You were asked about -- Let me follow it here.  
18 In page -- In Document 17, page 363, about the Heckler &  
19 Koch SP5 pistol.

20 A **Yes.**

21 Q In Document No. 10, page 47, it makes  
22 reference to the H&K 94?

23 A **Yes.**

24 Q Are you familiar with those firearms?

25 A **I am.**

Page 147

1 Q Is the H&K 94 a rifle version of the SP5?

2 A **It is.**

3 Q Do they use the same magazine?

4 A **They do.**

5 Q Is it legal if you own both a rifle and a  
6 pistol version of those firearms to purchase or possess a  
7 15-round magazine?

8 A **You would have to have the pistol variant.  
9 You would have to own the pistol variant to be legal.**

10 Q All right. And then could you, as a dealer,  
11 sell the 15-round magazine to somebody that said I want a  
12 magazine for my H&K 94?

13 A **No.**

14 Q Now, the ban prohibits possession of and  
15 transfer of the magazine; correct?

16 A **Yes.**

17 Q It doesn't prohibit inserting a magazine into  
18 a given firearm, does it?

19 A **Presumably, no.**

20 Q So how would the owner of an H&K 94 and an SP5  
21 know that they were legal buying a 15-round magazine?

22 A **They would not.**

23 Q On page 48 of Document 10, it's got the  
24 Kel-Tec SUB2000. Do versions of that accept Glock  
25 magazines?

Page 148

1 A **Yes.**

2 Q Do versions of that accept CZ 75 magazines?

3 A **Yes, they do.**

4 Q Is there a wide variety of otherwise, quote  
5 unquote, pistol magazines that the Kel-Tec SUB2000 will  
6 accept?

7 MR. WELLS: Object to form. Vague.

8 Q (By Mr. Maag) You can answer.

9 A **The SUB2000 accepts at least six different  
10 magazines.**

11 Q Do you know which six offhand?

12 A **Glock, Smith & Wesson, CZ, Kenik, Beretta, and  
13 Springfield Armory and others, I believe.**

14 Q All right. Are you familiar with the  
15 Smith & Wesson military and police pistol?

16 A **Yes.**

17 Q Are you aware of the carbine that  
18 Smith & Wesson came out with relatively recently, I guess  
19 this year, that accepts military and police magazines?

20 A **Yes, they are folding carbine.**

21 Q Very good. That's an article in the American  
22 Rifleman on it sometime this year. Are there rifle and  
23 pistol versions of the Uzi?

24 A **Yes.**

25 Q Are the magazines the same?



Page 149

1 **A They are.**

2 Q Are there rifle and pistol versions of the

3 Ruger 10/22?

4 **A There are.**

5 Q Are the magazines the same?

6 **A They are.**

7 Q If someone were to just randomly hand you a

8 13-round magazine in a given caliber, pick the caliber, it

9 really doesn't matter, and asked you whether or not that

10 magazine was legal in the State of Illinois, without

11 knowing more, could you answer that question under PICA?

12 **A No.**

13 Q Why not?

14 **A Because pistol -- a pistol or rifle magazine**

15 **could fit either potentially.**

16 Q So it potentially could be legal if it was a

17 pistol magazine?

18 **A Yes.**

19 Q Could potentially be illegal if it was a rifle

20 magazine?

21 **A Yes.**

22 Q And there's no way discern the two?

23 **A Not without having the individual firearms in**

24 **front of you.**

25 Q And even if you have the individual firearms,

Page 150

1 there could be rifle and pistol variants in both of those?

2 **A Correct.**

3 Q Are you familiar with the Sturm, Ruger &

4 Company Mini-14 tactical rifle M-14-20CF?

5 **A Yes.**

6 Q Does Ruger make a version of the Mini-14

7 that -- Well, okay. Can you describe the tactical rifle to

8 me?

9 **A The tactical version has different color**

10 **furniture, different features on it that would be**

11 **considered banned by PICA, such as adjustable stocks or**

12 **sometimes pistol grips.**

13 Q Does Ruger also make a plain version in a

14 traditional wooden stock?

15 **A They do.**

16 Q Would that be classified as a copy duplicate

17 variant or altered facsimile of a Ruger Mini-14 tactical

18 rifle?

19 **A It could be.**

20 Q Thus, PICA could very well prohibit a standard

21 Ruger Mini-14?

22 **A Yes.**

23 MR. WELLS: Object to form. Calls for a legal

24 conclusion.

25 Q (By Mr. Maag) Is there any way for a person to

Page 151

1 determine simply by looking at a standard Ruger Mini-14 or

2 a standard US M1 carbine whether that gun is legal under

3 PICA?

4 MR. WELLS: Objection. Form. Calls for a

5 legal conclusion.

6 **A It would be very difficult.**

7 Q (By Mr. Maag) All right. What have I handed

8 you?

9 **A These are lower and upper receivers for**

10 **different versions, copies of the AR-15 or AR 10.**

11 Q All right. The one closest to you on your

12 left, what is the manufacturer and model of that?

13 **A This is an Aero Precision M4 E1.**

14 Q Anywhere on that does it say AR in any way,

15 shape or form?

16 **A No.**

17 Q All right. Is that -- And feel free to look

18 at the Exhibit 9, if you need to, to refresh your

19 recollection. Is that fire -- Is that receiver listed on

20 the PICA banned list?

21 **A The M4 E1 is not listed.**

22 Q Simply by looking at Exhibit No. 9, the PICA

23 statute, is there any way for a person to discern whether

24 that lower receiver is legal or illegal in Illinois?

25 **A Because it is substantially similar, they**

Page 152

1 **could presume that it is a banned item.**

2 Q But that would require them to know what an

3 AR-15 lower looked like?

4 **A Yes.**

5 Q And if they didn't know what an AR-15 lower

6 looked like, would they be able to discern that?

7 **A Not without guidance potentially.**

8 Q And that receiver, in fact, is different than

9 a standard AR-15 lower, is it not?

10 **A It is.**

11 Q How is it different?

12 **A Things like the magazine well are opened up**

13 **larger. There's a trigger guard that is in place where a**

14 **standard AR-15 receiver uses an inserted pin and piece.**

15 **There's also additional holes drilled and pins used or**

16 **screws used instead of pins in a few places.**

17 Q Okay. So there are identifiable differences

18 between that receiver and an AR-15 receiver?

19 **A Yes.**

20 Q All right. And set that one down. The one

21 right above that, is that an AR-15 receiver?

22 **A No.**

23 Q Is that an AR-10 receiver?

24 **A It is not.**

25 Q Are you able to discern what that is?

Page 153

1       **A It is a copy of an AR-15 receiver that would**  
2 **accept only, it looks like, Glock magazines.**  
3       Q All right. And do you want to try it with a  
4 Glock magazine or are you fairly certain it accepts Glock  
5 magazines?  
6       **A I would presume on the shape and style of it**  
7 **that it would, but I can.**  
8       Q Okay. Simply by looking at that lower  
9 receiver, is there any way, shape or form for a person of  
10 ordinary intelligence to determine whether or not based on  
11 the statute in PICA whether that is a banned item?  
12       MR. WELLS: Objection to form. Calls for a  
13 legal conclusion.  
14       Q (By Mr. Maag) You can answer.  
15       **A This would be presuming that somebody had**  
16 **familiarity with PICA and with the differences between**  
17 **AR-15s and 9 millimeter copies of AR-15s.**  
18       Q So how would they determine that that would  
19 be -- would or would not be an AR-15 under PICA?  
20       **A I don't know that they could easily.**  
21       Q Can you think of any way you would do so,  
22 simply --  
23       **A No. I would say that it would be something**  
24 **that could be made into a rifle with banned features.**  
25       Q All right. Aside from the fact you could

Page 154

1 conceivably assemble it and do it right with banned  
2 features, could you assemble it to a rifle without banned  
3 features?  
4       **A Potentially, yes.**  
5       Q Okay. Either of the next lowers, it doesn't  
6 really matter which one. What is that one?  
7       **A This is a Palmetto G3 E10.**  
8       Q Is that -- Does that say on there AR, AR-15,  
9 AR-10, or anything like that?  
10       **A No.**  
11       Q Is that an AR-15?  
12       **A It is not.**  
13       Q Is that by name banned under PICA?  
14       **A I don't believe so. I would have to refer to**  
15 **the list.**  
16       Q All right. You don't recall seeing it on the  
17 list?  
18       **A I don't recall seeing the Palmetto G3 E10 on**  
19 **the list.**  
20       Q Could that be assembled, assuming that it was  
21 not banned by named item, into a legal firearm under PICA?  
22       **A It could be assembled into a bolt-action**  
23 **firearm or a single-shot-only firearm.**  
24       Q All right. If it didn't have pistol grips, a  
25 flash suppressor, sliding stock, and you took a queue from

Page 155

1 John Carpenter from Escape from New York and took the  
2 handgrips off of it, would that then potentially be a legal  
3 firearm in the State of Illinois, aside from the fact  
4 whether or not it's covered by name as a copy or duplicate?  
5       MR. MAAG: Objection to form. Compound.  
6 Legal conclusion.  
7       Q (By Mr. Maag) You can answer.  
8       **A If it had -- If it was not meeting the**  
9 **features definitional ban, then potentially.**  
10       Q Okay. Can you look at the next receiver in  
11 front of you? The next lower receiver. Does that say  
12 AR-15, AR-10 or anything remotely similar to that on there?  
13       **A It does not.**  
14       Q All right. And is that listed by make and  
15 model in the PICA banned list?  
16       **A No.**  
17       Q And what is the brand name on that?  
18       **A Benbow City Sports.**  
19       Q And what's the model?  
20       **A Model EE.**  
21       Q All right. And you have got an upper receiver  
22 in front of you?  
23       **A I do.**  
24       Q Does that fit that model EE?  
25       **A It appears to.**

Page 156

1       Q All right. Can you try it? Are you satisfied  
2 that they match?  
3       **A Yes.**  
4       Q All right. Can you try attaching the upper  
5 receiver on the Palmetto State Armory lower? And if you  
6 need to remove those plastic ties, feel free. Is that a  
7 match?  
8       **A It is not.**  
9       Q And why is that not a match?  
10       **A Because it's large gap in the back. While**  
11 **they may potentially fit together, they wouldn't**  
12 **necessarily safely function.**  
13       Q All right. Is it fair to say one is not a  
14 copy or a duplicate of the other, the lowers?  
15       **A Yes.**  
16       Q And are you familiar with the original AR-10?  
17       **A Fairly.**  
18       Q Was it semi-automatic, select fire or  
19 otherwise?  
20       **A Select fire, if I recall.**  
21       Q And where was it made?  
22       **A It was in the U.S.**  
23       Q Okay. Are you able to -- Are those receivers,  
24 any of those receivers in front of you, compatible with  
25 that original AR-10?

Page 157

1       **A Not without confirming that it would fit. I**  
2 **wouldn't be able to tell just from these parts. You can**  
3 **see the original AR-10 parts together as well.**  
4       MR. MAAG: Nothing further.  
5       MR. WELLS: Switch, and I'll ask a few more.  
6               EXAMINATION  
7 QUESTIONS BY MR. WELLS:  
8       Q Mr. Pulaski, are any of these items that  
9 Mr. Maag showed you laid out here on the table, are any of  
10 them yours?  
11       **A No.**  
12       Q Are any of them property of Piasa Armory?  
13       **A No.**  
14       Q You were asked about a Beretta styled  
15 magazine. Do you see it in here?  
16       MR. MAAG: It's in your hand.  
17       Q (By Mr. Wells) Sorry. Got it. And you were  
18 able to tell just by looking at that magazine that it's  
19 Beretta?  
20       **A Of that style, but it's not a Beretta branded**  
21 **magazine.**  
22       Q But it works in a Beretta pistol?  
23       **A I don't believe that it would.**  
24       Q Why not?  
25       **A That's a different brand.**

Page 158

1       Q What brand is it?  
2       **A I believe it's Taurus.**  
3       Q And you're able to tell that just from looking  
4 at it?  
5       **A Not from over there. No. I can't tell which**  
6 **brand that is. But Taurus and Beretta make similar**  
7 **magazines, but they don't necessarily fit each other.**  
8       Q So a Taurus magazine wouldn't necessarily work  
9 in a Beretta?  
10       **A Potentially, but it may not lock into the**  
11 **firearm.**  
12       Q And you see it has a 15 marking on that?  
13       **A It does.**  
14       Q What does that mean?  
15       **A In the industry it typically means the**  
16 **capacity.**  
17       Q So you can tell by looking at this magazine  
18 what the capacity is for that firearm based on that  
19 marking?  
20       **A In my experience, typically.**  
21       Q You were asked questions about if someone just  
22 handed you a magazine, you wouldn't necessarily be able to  
23 tell whether it was for a rifle or pistol. Do you recall  
24 that?  
25       **A Yes.**

Page 159

1       Q When customers come to you to purchase a  
2 magazine, do they typically know what firearm they are  
3 purchasing the magazine for?  
4       **A No.**  
5       Q They don't know at all?  
6       **A We oftentimes I need a magazine as the only**  
7 **statement from the customer. We ask them more clarifying**  
8 **questions, and their answers are usually for a certain**  
9 **caliber. We have to work with them to find out what type**  
10 **of gun that is for.**  
11       Q But you engage in a follow-up conversation  
12 with your customers; is that right?  
13       **A Yes.**  
14       Q And based on that conversation, you can direct  
15 them to a particular product?  
16       **A Yes.**  
17       Q And is that how things happen in the real  
18 world at Piasa Armory? People come in and see something  
19 and then you have conversations about them and then you  
20 direct them to a particular product that they are looking  
21 for?  
22       **A Typically.**  
23       Q Do you own an M1 carbine?  
24       **A I do.**  
25       Q Is it a rifle or pistol?

Page 160

1       **A Mine is a rifle.**  
2       Q If you were to replace the magazine for that  
3 M1 carbine, what round capacity would you purchase?  
4       **A Because it's a rifle, I would be required to**  
5 **do a 10-round magazine.**  
6       Q I think you were handed a 1911 frame. Do you  
7 recall that?  
8       **A Yes.**  
9       Q And Mr. Maag had you attach the stock to the  
10 1911. Do you recall that?  
11       **A Yes.**  
12       Q And at that point you called it a rifle; is  
13 that right?  
14       **A Yes.**  
15       Q Why did you call it a rifle?  
16       **A Because that is how the ATF defines it. So**  
17 **rifle or short-barreled rifle, presuming that's a complete**  
18 **firearm.**  
19       Q You were asked various questions about the  
20 receivers that are in front of you.  
21       **A Yes.**  
22       Q And by looking at the shape of the receiver,  
23 for something you were able to determine what type of  
24 caliber that the receiver would be suited for; is that  
25 right?



Page 161

1 **A Potentially.**  
 2 Q Is that a yes?  
 3 **A There's a variety of calibers that each**  
 4 **receiver is suited for.**  
 5 Q So, for instance, you were asked about, I  
 6 believe, a lower receiver that would accept Glock  
 7 magazines; is that right?  
 8 **A Yes.**  
 9 Q And you were able to identify just by looking  
 10 at the receiver that it was likely to use Glock magazines;  
 11 is that right?  
 12 **A Yes.**  
 13 Q With no other information other than just  
 14 looking at the receiver itself?  
 15 **A Based on the shape of the magazine well and**  
 16 **the angle that it's in.**  
 17 Q You were asked about the M1 Garand and a gas  
 18 and bolt system that it used?  
 19 **A Yes.**  
 20 Q The M1 Garand predates the AK-47 by a long  
 21 time; right?  
 22 **A Yes.**  
 23 Q You mentioned the Beretta AR-100. Do you  
 24 remember that?  
 25 **A I do.**

Page 162

1 Q And you would agree that the AR-100 shares a  
 2 basic shape with AR-15 style rifles?  
 3 **A Basic outline.**  
 4 Q So, yes, a basic outline?  
 5 **A Yes.**  
 6 Q You were asked about a broom handle --  
 7 **A Uh-huh (yes).**  
 8 Q -- pistol, do you recall that?  
 9 **A I do.**  
 10 Q Do you own a broom handle pistol?  
 11 **A I do.**  
 12 Q Prior to PICA taking effect, did you sell  
 13 broom handle pistols at Piasa Armory?  
 14 **A Occasionally, yes. I bought mine from our**  
 15 **company.**  
 16 Q How many have you sold?  
 17 **A I believe we have had about six come through**  
 18 **over the years.**  
 19 Q And that's since 2012 you sold six of that?  
 20 **A Yes.**  
 21 Q How many AR-15s have you sold since 2012?  
 22 **A Many more than six.**  
 23 Q How many? Just give me your best estimate.  
 24 **A Approximately 400 to 500 a year.**  
 25 Q So since 2012, 500 times 10, just going

Page 163

1 through 2022, that's 5,000?  
 2 **A Approximately.**  
 3 Q You were asked about the Norinco 86S. Do you  
 4 recall that?  
 5 **A Yes.**  
 6 Q And the Norinco 86S looks like an AK?  
 7 **A The receiver looks like an AK, but the rest of**  
 8 **the firearm looks nothing like an AK.**  
 9 Q You were asked about a receiver that had an M4  
 10 marking on it. Do you remember that?  
 11 **A Yes.**  
 12 Q There's something called an M4 carbine; right?  
 13 **A There is.**  
 14 Q And an M4 carbine is a carbine that's derived  
 15 from the M-16; right?  
 16 **A Yes.**  
 17 Q And the M-16 is derived from the AR-15?  
 18 **A Yes.**  
 19 Q So the M4 carbine -- In some instances, an M4  
 20 carbine can be an AR-15 style rifle; right?  
 21 **A M4 carbine is specifically marked on the**  
 22 **firearm. Colt, for example, uses that as a brand name or a**  
 23 **frontline name and their receivers are marked M4 carbine.**  
 24 Q And that's an AR-15 style rifle?  
 25 **A It's a variant of the AR-15.**

Page 164

1 Q You were asked about the H&K MR 566. Do you  
 2 recall that?  
 3 **A Yes.**  
 4 Q And the 556 there refers to 556 caliber  
 5 ammunition?  
 6 **A Typically.**  
 7 Q And that 556 caliber ammunition is a common  
 8 type of ammunition for an AR-15?  
 9 **A It is.**  
 10 Q I think you were also asked about the Kel-Tec  
 11 SUB2000 Gen2. Do you recall that?  
 12 **A I didn't. It's a generation, but yes.**  
 13 Q And is the Kel-Tec SUB2000 a pistol caliber  
 14 carbine?  
 15 **A It is a -- the Kel-Tec refers to it as**  
 16 **typically, yes.**  
 17 Q What is a pistol caliber carbine?  
 18 **A Usually pistol caliber carbines are rifle**  
 19 **length firearms, so 16-inch barrel or greater, that uses a**  
 20 **traditionally pistol caliber round.**  
 21 Q The Beretta CX4 Storm, is that also a pistol  
 22 caliber carbine?  
 23 **A It is.**  
 24 Q I think you were handed a receiver as well and  
 25 you were asked about whether the receiver could be combined

Page 165

1 with different parts to make it into an assault weapon as  
 2 defined under PICA. Do you recall that?  
 3 **A Yes.**  
 4 Q The receiver itself, in order for someone to  
 5 combine it with other parts to bring it within the  
 6 definition of PICA, that person would have to know about  
 7 the particular parts that they are assembling; right?  
 8 **A The receiver itself is a banned part, because**  
 9 **it's a part that be used to assemble an assault weapon.**  
 10 Q Maybe I'm misremembering what you were talking  
 11 about earlier, but you were specifically testifying about a  
 12 receiver that could be used for a pistol that would not be  
 13 covered by PICA. Do you recall that?  
 14 **A Right.**  
 15 Q And that same receiver could also be used and  
 16 combined with other parts to become a receiver for a rifle  
 17 with certain features that would bring it into PICA; right?  
 18 **A Potentially.**  
 19 Q So a person designing that, they would have to  
 20 know how to put the different parts together; right?  
 21 **A They would.**  
 22 Q And they would have to specifically choose  
 23 particular parts to combine with that receiver?  
 24 **A Yes.**  
 25 Q And in the course of doing that, they would

Page 166

1 make choices about whether to combine specific parts to  
 2 reach a certain desired firearm at the end of the day;  
 3 right?  
 4 **A Yes.**  
 5 Q You were showed a couple of receivers and you  
 6 described them as standard AR-15 lowers. Do you recall  
 7 that?  
 8 **A I don't recall that.**  
 9 Q I believe Mr. Maag may have used the phrase  
 10 standard AR-15 lowers. Are you familiar with that  
 11 terminology?  
 12 **A I am.**  
 13 Q What is a standard AR-15 lower?  
 14 **A A standard AR-15 lower looks similar to this**  
 15 **on the outside, but is different on the internal dimensions**  
 16 **and magazine.**  
 17 Q Okay. Is there a standard AR-15 lower in  
 18 front of you on the table?  
 19 **A No.**  
 20 Q But when Mr. Maag was using the term standard  
 21 AR-15 lower, you understood what he meant?  
 22 **A I did.**  
 23 Q And the "this" that you were just pointing to,  
 24 when you said it looks like this, that was the lower  
 25 receiver that uses Glock magazines; is that right?

Page 167

1 **A Yes.**  
 2 Q You mentioned when you combined a lower  
 3 receiver and an upper receiver, one of which was from  
 4 Palmetto, do you recall that?  
 5 **A Yes.**  
 6 Q And they didn't exactly line up; is that  
 7 right?  
 8 **A Yes.**  
 9 Q And if a person were to combine those, the  
 10 lower receiver and the upper receiver, you said it wouldn't  
 11 safely function; is that right?  
 12 **A Correct.**  
 13 Q What did you mean?  
 14 **A The firearm may not function properly. It**  
 15 **may -- Because there's an opening in the back, they could**  
 16 **have a pinch or safety point that they could get an**  
 17 **extremity into.**  
 18 MR. WELLS: Subject to my prior objections, I  
 19 don't have anything further at this time.  
 20 MR. MAAG: You have the option to read this  
 21 transcript looking for typographical errors. You cannot  
 22 change an answer, except for correcting a typographical  
 23 error. You don't have to read it. You can waive  
 24 signature. But it's up to you. I have no preference.  
 25 **THE WITNESS: What's the standard for such?**

Page 168

1 MR. MAAG: It's whatever the witness wants to  
 2 do.  
 3 **THE WITNESS: I trust the court reporter.**  
 4 MR. MAAG: So you waive?  
 5 **THE WITNESS: I'll waive.**  
 6 MR. MAAG: Okay. Thank you.  
 7 THE VIDEOGRAPHER: This ends the  
 8 video-recorded deposition of Scott Pulaski. We are going  
 9 off the record. The time now is 6:04.  
 10  
 11 SIGNATURE WAIVED, BY AGREEMENT OF COUNSEL  
 12 AND WITNESS.  
 13  
 14 (Deposition was adjourned at 6:05 p.m.)  
 15  
 16  
 17  
 18  
 19  
 20  
 21  
 22  
 23  
 24  
 25

CERTIFICATE OF REPORTER

1  
2  
3  
4  
5  
6  
7  
8  
9  
10  
11  
12  
13  
14  
15  
16  
17  
18  
19  
20  
21  
22  
23  
24  
25

I, Jamie Jo Kinder, CCR No. 842, CSR No. 084.003306, do hereby certify that the witness whose testimony appears in the foregoing deposition was duly sworn by me; that the testimony of said witness was taken by me to the best of my ability and thereafter reduced to typewriting under my direction; that I am neither counsel for, related to, nor employed by any of the parties to the action in which this deposition was taken, and further that I am not a relative or employee of any attorney or counsel employed by the parties thereto, nor financially or otherwise interested in the outcome of the action.



Certified Shorthand Reporter



--	--	--	--

--	--	--	--

--	--	--	--



--	--	--	--

--	--	--	--

--	--	--	--



--	--	--	--

--	--	--	--

--	--	--	--

--	--	--	--



--	--	--	--

--	--	--	--

--	--	--	--

--	--	--	--



--	--	--	--

--	--	--	--

--	--	--	--

--	--	--	--



--	--	--	--

--	--	--	--

--	--	--	--

--	--	--	--



--	--	--	--

--	--	--	--

--	--	--	--

--	--	--	--



--	--	--	--

--	--	--	--

--	--

# Exhibit B-1





IN THE CIRCUIT COURT  
CRAWFORD COUNTY, ILLINOIS

<b>JEREMY W. LANGLEY,</b>	)	
<b>TIMOTHY B. JONES and</b>	)	
<b>MATTHEW WILSON,</b>	)	
	)	
v.	)	Case No.
	)	
<b>BRENDAN KELLY, in his official</b>	)	
<b>capacity as Director of the Illinois</b>	)	
<b>State Police, and COLE PRICE SHANER,</b>	)	
<b>in his official capacity as States Attorney of</b>	)	
<b>Crawford County, Illinois,</b>	)	
	)	
<b>Defendants.</b>	)	

**AFFIDAVIT OF SCOTT PULASKI**

Comes now Scott Pulaski, being first sworn, and under penalties of perjury, states as follows:

1. My name is Scott Pulaski. I am an owner of Piasa Armory, location in Alton, Illinois.
2. Piasa Armory is a Type 07 FFL, which is a firearm manufacturing and dealing license issued by the federal government. In addition, Piasa Armory holds a Class II Special Occupational Taxpayer endorsement, entitling it to manufacture most firearms regulated under the federal National Firearms Act. In addition, Piasa Armory is registered with the Illinois State police as a firearms dealer.
3. I am personally familiar with firearms, both historical and modern. as well as firearms regulations, both in Illinois and nationally, on account that ATF, the federally agency that licenses my business, makes me comply with all such laws, and provides me a publication listing the current ones.

EA

4. In addition to being a firearms dealer, Piasa Armory and myself teach Illinois State Police certified concealed carry classes, both new and renewal.
5. I am also familiar with what is popular for sale and purchase with Illinois residents and citizens.
6. I am aware that this case was filed to challenge purported Public Act 102-1116, commonly called an gun and magazine ban.
7. I am aware that the Public Act purports to ban general possession and most transfers of magazines that hold over 10 rounds, for rifles and shotguns, and over 15 rounds for pistols.
8. That there is no realistic way to determine that a given firearm magazines is for a pistol, or for a rifle, as many rifles and pistols use the exact same magazine. For instance, many Kel-Tec 9mm rifles use Glock or Beretta magazines, which are often used in Glock and Beretta pistols, respectively. Likewise, many pistols use magazines originally used in rifles. In fact, even as a “firearms expert”, I cannot discern a “rifle magazine” from a “pistol magazine” simply by looking at it.
9. In addition, the Public Act purports to require owners to register their subject firearms. Almost no states have firearm registration, it previously existed only briefly in Illinois, about 50 years ago, and was repealed because nobody complied with it. In the pre-20<sup>th</sup> Century era, I am unaware of any regulation on firearms analogous to registration.
10. In addition, the Public Act purports to ban revolving shotguns. These have existed since at least 1855, when Colt manufactured such items before the Civil War. Taurus sells such a firearm, which is commonly sold throughout the United States.

11. In addition, the ban outlaws shotguns with either pistol grips or detachable magazines.  
These shotguns are very popular and commonly owned, both for sporting and defense purposes.
12. In addition, the ban outlaws pistols with threaded barrels, magazines outside of the grip, large pistols, and the like. Again, these pistols are commonly owned and popular for sports and defense. In fact, pistols like these are used in the Olympic target shooting competition.
13. In addition, the ban outlaws common semi automatic rifles, like the AR-15, the Springfield M1A, and actually even the standard SKS and M1 Garand.
14. Both the standard Soviet SKS, as well as Chinese, Yugoslavian and Romanian SKS rifles can be, and many have been, converted to detachable magazine, and have a barrel shroud that can be held by the non firing hand.
15. Likewise, the M1 Garand can be, and has been, converted to detachable magazine configuration, with John Garand himself making such conversions to accept BAR magazines, and the Italian companies Beretta and Breda both making them into detachable magazine BM59 rifles. The M1 also has a wood barrel shroud.
16. In fact, nearly any semi automatic, bolt action, or lever action rifle can be converted into a detachable magazine semi automatic. In fact, John Browning's first machinegun, was a conversion of a Winchester Model 1892 lever action rifle into a machinegun.
17. The ban also includes the Colt AR15, and various other listed firearms, by make and model, along with "copycats". Other than by make and model marking, it is impossible for anyone to discern, objectively, whether a firearm is such a copycat, and no guidance is provided as to how much difference is required. For instance, the Colt AR15 used a

different size threaded front take down pin hole than most similar firearms. Some have solid trigger groups, some do not. Some have threaded pin holes, some use coil pins. Some accept drop in trigger groups, some do not. There are at least two sizes of trigger parts that might arguably fit into such rifles. M1 Carbine trigger groups are mechanically similar to Colt AR15 groups. The copycat ban is so vague that not even experts can discern what is a copycat.

18. The simple fact of the matter is, the very semi automatic firearms listed in the ban, are the either the most popular firearms in the United States, with literally tens of millions sold in the past few years, or simply, such as is the case with the Beretta 93 listed, not even a semi-automatic, rather, it is a machinegun version of the common Beretta 92 pistol. Likewise, while cosmetically similar semi auto only models were made, with different model numbers, the AR10, as originally manufactured, is also a machinegun, as is and was the Beretta AR70, the Steyr AUG and the FN FAL. The entire ban is arbitrary and obviously written by people with no knowledge of firearms.
19. In addition, as to the ban on over 10 or over 15 round magazines, both are simply not in compliance with what is actually popular and on the market. Since the Glock 17 of 1980, over 15 round magazines for pistols are common and the most popular. Those with less than 15 rounds are generally historical and obsolete, with most, like the Walther P38, actually out of production.
20. As to rifle magazines, since 1941, when the U.S. Military adopted the M1 Carbine, first 15 round, and later in 1944, 30 round magazines were standard. In 1957, with the adoption of the M14, in the U.S., and the FN FAL in most western nations, 20 round magazines were standard for those rifles, as well as their U.S. commercially sold versions. The M16



was designed in the late 1950s with a 20 round magazine, and sold commercially, in semi auto, in 1964 with a 20 round standard magazine. By the 1970s, 30 round magazines had become standard. Today, 28 to 35 round magazine are standard for self defense and target shooting rifles, for most semi automatic rifles sold in the U.S. today, nationwide, as well as the State of Illinois.

26. As to the .50 BMG, it is also a commonly owned firearm and ammunition. It is commonly used for long range target shooting, with the ammunition being sold on the market since at least the 1920s, and firearms commonly available since at least the 1980s. Many long range records are held by .50 BMG sporting rifles.

27. Rifles, with bore diameters of well over .50 inches have been commonly owned since will before the American Revolution. In fact, the standard British Brown Bess bore diameter during the American Revolution was .75 inches, of half again larger than the .50 BMG. .69 caliber firearms were commonly held and used after the Revolution by Americans, with .577 rifles standard from 1855 to about 1872.

28. That the ban has made it impossible for me, and other licensed dealers, to sell or transfer to Illinois residents, what has been the most popular firearms and magazines in Illinois and the U.S. previously.

29. In fact, due to various vague terms in the ban, many wholesalers are refusing to even ship replacement parts to Illinois addresses.

30. In this ban is allowed to stand, the average Illinoisan will be limited to firearms designed in the 1890s and earlier, instead of modern firearms.

Under penalties as provided by law pursuant to Section 1-109 of the Code of Civil Procedure, the undersigned certifies that the statements set forth in this instrument are true and correct, except

as to matters therein stated to be on information and belief and as to such matters the

undersigned certifies as aforesaid that he verily believes the same to be true.

Dated: 01/23/23

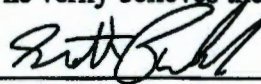
  
\_\_\_\_\_  
Scott Pulaski

# Exhibit B-2



**IN THE UNITED STATES DISTRICT COURT  
FOR THE SOUTHERN DISTRICT OF ILLINOIS**

**CALEB BARNETT, et al.,** )  
)  
**Plaintiffs,** )  
)  
**vs.** ) **Case No. 3:23-cv-209-SPM**  
)  
**KWAME RAOUL, et al.,** )  
)  
**Defendants.** )

---

**DANE HARREL, et al.,** )  
)  
**Plaintiffs,** )  
)  
**vs.** ) **Case No. 3:23-cv-141-SPM**  
)  
**KWAME RAOUL, et al.,** )  
)  
**Defendants.** )

---

**JEREMY W. LANGLEY, et al.,** )  
)  
**Plaintiffs,** )  
)  
**vs.** ) **Case No. 3:23-cv-192-SPM**  
)  
**BRENDAN KELLY, et al.,** )  
)  
**Defendants.** )

---





**STATEMENT PURSUANT TO 28 USC 1746**

1. My name is Scott Pulaski, I am over 21 years of age, under no legal disabilities, and make this sworn statement either under personal knowledge, or for historical matters, based upon my knowledge, training and education on the subject, including books relied on by others in the field that are accepted as authoritative.
2. I am an owner of a firearms store, licensed by both the State of Illinois, and the BATF, with a Type 07 Federal Firearms License and a Class II SOT, allowing me to deal in and manufacture firearms, including those regulated under the National Firearms Act. I have been in this business many years, and operate what is likely the largest such store in Madison County.
3. I have studied firearms most of my life.
4. I have also collected, shot and studied firearms for years before owning a firearms dealer.
5. I have taught many firearms related classes, including teaching firearm self defense and concealed carry.
6. I am familiar with firearms generally, as well as the following models and kinds of firearms, as well as the magazines or other ammunition feeding devices they use:
  - A. Beretta M 9 Pistol, and
  - B. Beretta CX4 Storm rifle, and
  - C. Remington Model 870, including the DM variant and the Tac14 variant, and
  - D. The Soviet AK47,
  - E. The SKS rifle, including those with detachable magazines,
  - F. The Walther K43, also known as the G43,
  - G. The U.S. military issue M16 series,

- H. The Colt AR15 series
  - I. The Check vz52 and vx58,
  - J. The m1 Garand,
  - K. The Beretta BM59,
  - L. The Browning Model 1919 series, including semiautomatic copies,
  - M. The Japanese Type 3 machinegun
  - N. M1 and M2 carbine.
  - O. the AR7
  - P. the AR17 and
  - Q. the AR24
7. I am also familiar with a brand of Vodka sold under the AK47 name, usually in a glass container more or less in the shape of an AK47 rifle.
  8. That is it objectively impossible to determine whether a given magazine, feed strip, or other ammunition feeding device is for a rifle, shotgun, handgun or something else, simply by looking at the device.
  9. For instance, the magazine for a Beretta M9 pistol is identical and interchangeable with that of the Beretta CX4 rifle. Likewise, many rifles use Glock pistol magazines, including the Kel-Tec, and Ruger sells rifles that use the same magazines as Glock pistol and Ruger pistols. A magazine that fits an AR15 or AK47 rifle will also fit a pistol of similar design, as well as firearms not classified as rifle, shotgun or pistol, such as the federal AOW category or other category.
  10. The Remington 870 DM shotgun uses the same magazine as the non-shoulder fired Remington 870 Tac 14 DM.

11. U.S. M1 carbine magazines will fit rifle, pistol and other versions of said carbine interchangeably.
12. Other models of firearms I can think of off hand, which use magazines that can be and commonly are used in both rifles and pistols, as well as "other" firearms, are AK47 type magazines, AR15 type magazines, Luger magazines, 1911 magazines, Smith and Wesson 59 magazines, Ruger 10-22 magazines, Soviet PPS43 type magazines, Uzi type magazines, and Thompson model 1928 type magazines.
13. As to the named firearms in the Illinois ban, as I previously stated, I am familiar with both the AK, or Soviet Avtomat Kalashnikov series of rifles, which is a 1947 Soviet designed select fire shoulder fired weapon, that under federal law would be a machinegun. According to official Soviet propaganda, the firearm was designed by a wounded former Soviet army tank mechanic named Mikhail T. Kalashnikov. The firearm, and its actual derivatives, use an M1 Garand style gas and bolt system, a Remington Model 8 safety/selector, and are made from either machined or stamped steel components,
14. The SKS was designed by Sergey Gavrilovich Simonov, a Soviet weapons designer, and unlike the AK47 based designs, was actually designed in 1944, and first used in prototype form in the Ukraine by Belorussian troops in the Soviet Army also in 1944. The SKS operating system has nothing in common with the AK47, and instead, although some claim it to be a scaled down PTRS 14.5mm anti tank rifle, in fact it is a near complete copy of the Walther G43, aka K43 rifle of World War II, except the SKS usually comes with a fixed magazine, and in a 7.63x39mm Soviet Short chambering, as opposed to the 7.92x57mm Mauser chambering, and detachable magazine of the G43. An fixed

magazine SKS can be made into a detachable magazine SKS by simply taking out the trigger group and magazine, and replacing only the trigger group.

15. The G43 itself, is a product improved Tokarev gas system, lifted from the SVT series of rifles used by the Soviet Union, in 7.62x54R caliber.
16. The SKS is not, under any circumstances, a copy, close, derivative or based on an AK of any kind.
17. Neither is the Check vz58 or the German StG44 rifles, which also use completely different operating systems than the AK47, and were designed independently of the AK47.
18. Based strictly on the terms of the statute, I am unable to discern what is meant by “all AK types”. For instance, would this include a .22 rifle made to look like an AK47? If an SKS is treated as an AK type, despite obviously not being one, I am unsure whether an M1 Garand, or a Ruger Mini 30, would also be so classified, as they use the same bolt and operating system style, despite being completely different firearms
19. As back the ban, it also generally prohibits *inter alia* “all AR Type”, and states this includes the AR15, the Armalite M15 .22LR Carbine, the Beretta AR70 and the Rock River Arms AR47.
20. An AR15 is a patented model number of a rifle only made by Colt, that uses a direct impingement gas system, copied out of a Swedish AG42 rifle, also used by the French M1949 series of rifle, including the M49/56, except that the AR15 uses a rotary bolt. The AR15 also uses magazines designed for it, sometimes called STANAG magazines, that have become industry standard in the caliber.



21. The Armalite M15 .22LR Carbine is designed to LOOK LIKE, an early prototype AR15, circa about 1964, by is in a different caliber, has no gas system, and completely different operating system, and uses different magazines.
22. The Beretta AR70 has nothing in common with the AR15, except caliber, and while the AR15 is made from machined aluminum, the AR70 is made from largely stamped steel. No parts between the two interchange.
23. There is no such gun as the Rock River Arms AR47, but if that is intended to refer to the LAR-47, again, there are substantial differences, including caliber, magazine used and the general appearance.
24. In sum, there is no objective way that a person can determine whether or not a given magazine is a “handgun” magazine or a “rifle” magazine under the Act, as they are identical.
25. There is no objective way that a person can determine that any ammunition feeding device is for a rifle, shotgun, pistol or other firearm, without knowing its design history, possibly going back well over a century, and without knowing about every single firearm ever made that might use that assumption feeding device.
26. Likewise, there are no objective standards to determine whether a given firearm is an AK type, an AR type, or something else. In fact, even the listed examples are often times not within the parameters of what even most firearms experts would consider to be an AK type, like the SKS, of an AR type.
27. That I have read the Plaintiff’s Motion for Partial Summary Judgment as to Counts IV and VI, and to the best of my knowledge, the facts set forth in this sworn statement, and

in that motion, are true and correct. The photographs depicted show what they are labeled as correctly, and the descriptions contained in the motion are accurate.

28. If I were to testify in open court, I would testify consistently with this affidavit.

29. I declare under penalty of perjury under the laws of the United States of America that the foregoing is true and correct.

Dated: 05/18/23

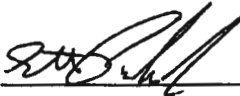

---

Scott Pulaski



# Exhibit B-3

Cover Page Only Due to Length



## State Laws and Published Ordinances – Illinois

Current through P.A. 102-557 and 102-662 of the 2021 Session of the 102<sup>nd</sup> General Assembly.

**Office of the Attorney General**  
100 West Randolph Street  
Chicago, IL 60601  
**Voice:** (312) 814-3000  
<http://www.illinoisattorneygeneral.gov/>



**Chicago Field Division**  
175 West Jackson Blvd., Suite  
1500 Chicago, IL 60604  
**Voice:** (312) 846-7200  
<https://www.atf.gov/chicago-field-division>



### Table of Contents

#### **Chapter 430 – Public Safety Firearm Owners Identification Card Act**

Section 430 ILCS 65/1.1. Firearm defined; Firearm ammunition defined.  
Section 430 ILCS 65/1.1. Firearm defined; Firearm ammunition defined.  
Section 430 ILCS 65/2. Firearm Owner's Identification Card required; exceptions.  
Section 430 ILCS 65/3. Transfer of firearms; records; exceptions.  
Section 430 ILCS 65/3a. Reciprocal rights in Iowa, Missouri, Indiana, Wisconsin and Kentucky.  
Section 430 ILCS 65/3.1 Firearm Transfer Inquiry Program.  
Section 430 ILCS 65/3.1. Dial up system.  
Section 430 ILCS 65/3.2. List of prohibited projectiles; notice to dealers.  
Section 430 ILCS 65/4. Application for Firearm Owner's Identification Cards.  
Section 430 ILCS 65/4. Application for Firearm Owner's Identification Cards.  
Section 430 ILCS 65/5. Approval and renewal  
Section 430 ILCS 65/5. Approval and renewal  
Section 430 ILCS 65/6. Contents of Firearm Owner's Identification Card.  
Section 430 ILCS 65/6. Contents of Firearm Owner's Identification Card.  
Section 430 ILCS 65/7. Validity of Firearm Owner's Identification Card.  
Section 430 ILCS 65/7.5 Email and Text Message Notifications  
Section 430 ILCS 65/8. Grounds for denial and revocation.  
Section 430 ILCS 65/8.1. Notifications to the Department of State Police.  
Section 430 ILCS 65/8.2. Firearm Owner's Identification Card denial, suspension, or revocation.  
Section 430 ILCS 65/8.2. Firearm Owner's Identification Card denial or revocation.  
Section 430 ILCS 65/8.3. Suspension of Firearm Owner's Identification Card.  
Section 430 ILCS 65/8.3. Suspension of Firearm Owner's Identification Card.  
Section 430 ILCS 65/8.4 Cancellation of Firearm Owner's Identification Card  
Section 430 ILCS 65/8.5 Illinois State Police to Monitor Databases for Firearms Prohibitors  
Section 430 ILCS 65/9. Grounds for denial or revocation.  
Section 430 ILCS 65/9.5. Revocation of Firearm Owner's Identification Card.  
Section 430 ILCS 65/9.5. Revocation of Firearm Owner's Identification Card.  
Section 430 ILCS 65/10. Appeal to Director; Hearing; Relief from firearm prohibitions.  
Section 430 ILCS 65/11. Judicial review of final administrative decisions.  
Section 430 ILCS 65/12. Transfer of firearms upon death of owner or incident to legal proceedings.  
Section 430 ILCS 65/13. Acquisition or possession otherwise prohibited.  
Section 430 ILCS 65/13.1. Preemption.  
Section 430 ILCS 65/13.2. Renewal; name, photograph, or address change; replacement card.

Section 430 ILCS 65/13.2. Renewal; name or address change; replacement card.

#### **Firearm Concealed Carry Act**

Section 430 ILCS 66/10.5 Electronic Concealed Carry Licenses

Section 430 ILCS 66/85. Background checks for sales.

#### **Firearms Restraining Order Act**

Section 430 ILCS 67/5. Definitions. [Effective until June 1, 2022]

Section 430 ILCS 67/5. Definitions. [Effective June 1, 2022]

Section 430 ILCS 67/10. Commencement of action; procedure. [Effective until June 1, 2022]



Section 430 ILCS 67/10. Commencement of action; procedure. [Effective June 1, 2022]  
Section 430 ILCS 67/15. Subject matter jurisdiction.  
Section 430 ILCS 67/20. Jurisdiction over persons.  
Section 430 ILCS 67/25. Process.  
Section 430 ILCS 67/30. Service of notice of hearings.  
Section 430 ILCS 67/35. Ex Parte orders and emergency hearings.  
Section 430 ILCS 67/35 Ex parte orders and emergency hearings. [Effective until June 1, 2022]  
Section 430 ILCS 67/35 Ex parte orders and emergency hearings. [Effective June 1, 2022]  
Section 430 ILCS 67/40. Six month orders.  
Section 430 ILCS 67/40 Six-month orders. [Effective until June 1, 2022]  
Section 430 ILCS 67/40 Six-month orders. [Effective June 1, 2022]  
Section 430 ILCS 67/45. Termination and renewal. [Effective June 1, 2022]  
Section 430 ILCS 67/45 Termination and renewal. [Effective June 1, 2022]  
Section 430 ILCS 67/50. Notice of orders.  
Section 430 ILCS 67/55. Data maintenance by law enforcement agencies.  
Section 430 ILCS 67/60. Filing of a firearms restraining order issued by another state.  
Section 430 ILCS 67/65. Enforcement; sanctions for violation of order.  
Section 430 ILCS 67/70. Non-Preclusion of remedies.  
Section 430 ILCS 67/80. Expungement or sealing of order.

# Exhibit B-4

Cover Page Only Due to Length



U.S. Department of Justice  
Bureau of Alcohol, Tobacco, Firearms and Explosives  
*Enforcement Programs and Services*

# ATF

## Federal Firearms Regulations Reference Guide

2014





# Exhibit B-5



### Gunsmith Services



#### Service by the Hour \$ 80

Broken or missing pieces? Minor or major adjustments? Our staff can handle any service your firearm needs!  
\*pricing does not include parts



#### Ultrasonic Cleaning \$ 40

Get that firearm back to factory clean with our in depth ultrasonic cleaning.  
Note: some finishes are not suitable for ultrasonic cleaning and will be hand cleaned.

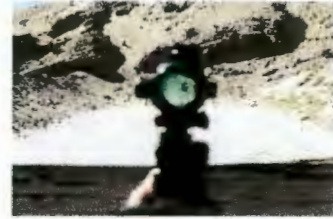

#### Scope or sight install \$ 40

We've got the tools to mount and bore-sight your scopes or sights. Hitting the target is up to you!  
\*pricing does not include parts



#### Quick Fixes \$ 10

Get that screw unstuck, break free a castle nut, put on a flash hider. We can take care of the little jobs too, usually while you wait. Call ahead to check availability for this service.  
\*pricing does not include parts



#### AR-15 Build Room \$40

For \$40 you can have access to our AR Build Room. All the tools included that you need to complete or modify your build.



COPYRIGHT © 2023 PIASA ARMORY - ALL RIGHTS RESERVED.

# Exhibit B-6



**U.S. Department of Justice**

Bureau of Alcohol, Tobacco,  
Firearms and Explosives  
*Office of Enforcement Programs and Services*  
*Office of Field Operations*

---

Washington, DC 20226  
[www.atf.gov](http://www.atf.gov)

March 22, 2022

**OPEN LETTER TO ALL FEDERAL FIREARMS LICENSEES**

The Bureau of Alcohol, Tobacco, Firearms and Explosives (ATF) recently examined devices commonly known as “forced reset triggers” (FRTs) and has determined that some of them are “firearms” and “machineguns” as defined in the National Firearms Act (NFA), and “machineguns” as defined in the Gun Control Act (GCA).

These particular FRTs are being marketed as replacement triggers for AR-type firearms. Unlike traditional triggers and binary triggers (sometimes referred to generally as “FRTs”), the subject FRTs do not require shooters to pull and then subsequently release the trigger to fire a second shot. Instead, these FRTs utilize the firing cycle to eliminate the need for the shooter to release the trigger before a second shot is fired. By contrast, some after-market triggers have similar components but also incorporate a disconnecter or similar feature to ensure that the trigger must be released before a second shot may be fired and may not be machineguns.

Both the NFA and GCA regulate machineguns. “Machinegun” is defined under 26 U.S.C. § 5845(b) and 18 U.S.C. § 921(a)(23) as—

Any weapon which shoots, is designed to shoot, or can be readily restored to shoot, automatically more than one shot, without manual reloading, by a single function of the trigger. The term shall also include the frame or receiver of any such weapon, any part designed and intended solely and exclusively, *or combination of parts designed and intended, for use in converting a weapon into a machinegun*, and any combination of parts from which a machinegun can be assembled if such parts are in the possession or under the control of a person. (Emphasis added.)

ATF’s examination found that some FRT devices allow a firearm to automatically expel more than one shot with a single, continuous pull of the trigger. For this reason, ATF has concluded that FRTs that function in this way are a combination of parts designed and intended for use in converting a weapon into a machinegun, and hence, ATF has classified these devices as a “machinegun” as defined by the NFA and GCA.

Accordingly, ATF’s position is that any FRT that allows a firearm to automatically expel more than one shot with a single, continuous pull of the trigger is a “machinegun”, and is accordingly subject to the GCA prohibitions regarding the possession, transfer, and transport of machineguns



**OPEN LETTER TO ALL FEDERAL FIREARMS LICENSEES (cont.)**

under 18 U.S.C. §§ 922(o) and 922(a)(4). They are also subject to registration, transfer, taxation, and possession restrictions under the NFA. *See* 26 U.S.C. §§ 5841, 5861; 27 CFR 479.101.

Under 26 U.S.C. § 5871, any person who violates or fails to comply with the provisions of the NFA may be fined up to \$10,000 per violation and is subject to imprisonment for a term of up to ten years. Further, pursuant to 26 U.S.C. § 5872, any machinegun possessed or transferred in violation of the NFA is subject to seizure and forfeiture. Under 18 U.S.C. § 924(a)(2), any person who violates § 922(o) may be sent to prison for up to 10 years and fined up to \$250,000 per person or \$500,000 per organization.

Based on ATF's determination that the FRTs that function as described above are "machineguns" under the NFA and GCA, ATF intends to take appropriate remedial action with respect to sellers and possessors of these devices. Current possessors of these devices are encouraged to contact ATF for further guidance on how they may divest possession. If you are uncertain whether the device you possess is a machinegun as defined by the GCA and NFA, please contact your local ATF Field Office. You may consult the local ATF Office's webpage for office contact information.

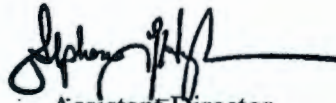

Assistant Director  
Enforcement Programs and Services

GEORGE LAUDER  
Digitally signed by  
GEORGE LAUDER  
Date: 2022.03.22  
13:25:39 -04'00'

Assistant Director  
Field Operations

# Exhibit B-7

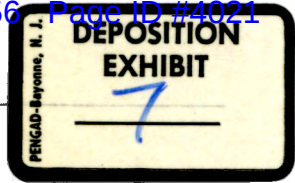

## § 478.12 Definition of Frame or Receiver.

- a. Except as otherwise provided in this section, the term “frame or receiver” means the following—
1. The term “frame” means the part of a handgun, or variants thereof, that provides housing or a structure for the component (i.e., sear or equivalent) designed to hold back the hammer, striker, bolt, or similar primary energized component prior to initiation of the firing sequence, even if pins or other attachments are required to connect such component (i.e., sear or equivalent) to the housing or structure.
  2. The term “receiver” means the part of a rifle, shotgun, or projectile weapon other than a handgun, or variants thereof, that provides housing or a structure for the primary component designed to block or seal the breech prior to initiation of the firing sequence (i.e., bolt, breechblock, or equivalent), even if pins or other attachments are required to connect such component to the housing or structure.
  3. The terms “variant” and “variants thereof” mean a weapon utilizing a similar frame or receiver design irrespective of new or different model designations or configurations, characteristics, features, components, accessories, or attachments. For example, an AK-type firearm with a short stock (i.e., pistol grip) is a pistol variant of an AK-type rifle, an AR-type firearm with a short stock (i.e., pistol grip) is a pistol variant of an AR-type rifle, and a revolving cylinder shotgun is a shotgun variant of a revolver.
  4. The following are nonexclusive examples that illustrate the above definitions:

i. **Hinged or single framed revolvers:**

The frame is the part of the revolver that provides a structure designed to hold the sear.

Figure 1 to paragraph (a)(4)(i)

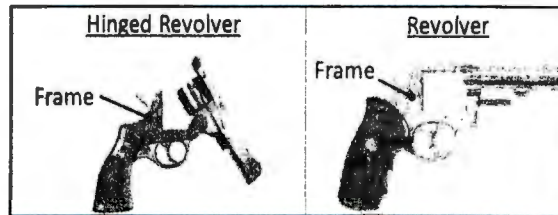

ii. **Colt 1911, Beretta/Browning/FN Herstal/Heckler & Koch/Ruger/Sig Sauer/Smith & Wesson/Taurus hammer-fired semiautomatic pistols:**

The frame is the lower portion of the pistol, or grip, that provides housing for the sear.

Figure 2 to paragraph (a)(4)(ii)



iii. **Glock variant striker-fired semiautomatic pistols:**

The frame is the lower portion of the pistol, or grip, that provides housing for the sear.

Figure 3 to paragraph (a)(4)(iii)

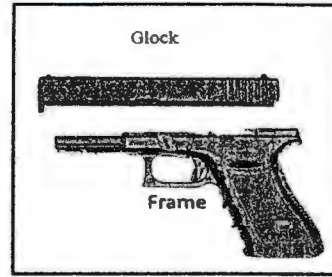

iv. Sig Sauer P250/P320 variant semiautomatic pistols:

The frame is the internal removable chassis of the pistol that provides housing for the sear or equivalent component.

Figure 4 to paragraph (a)(4)(iv)



v. Bolt action rifles:

The receiver is the part of the rifle that provides a structure for the bolt.

Figure 5 to paragraph (a)(4)(v)

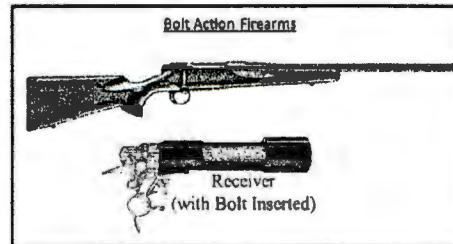

vi. Break action, lever action, or pump action rifles and shotguns:

The receiver is the part of the rifle or shotgun that provides housing for the bolt, breechblock, or equivalent.

Figure 6 to paragraph (a)(4)(vi)



vii. AK variant firearms:

The receiver is the part of the weapon that provides housing for the bolt.



Figure 7 to paragraph (a)(4)(vii)

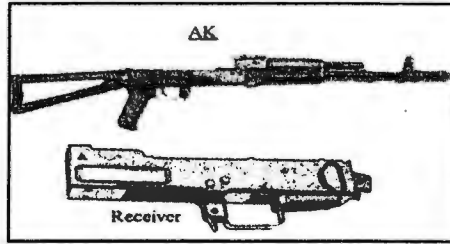

viii. Steyr AUG variant firearms:

The receiver is the central part of the weapon that provides housing for the bolt.

Figure 8 to paragraph (a)(4)(viii)



ix. Thompson machineguns and semiautomatic variants, and L1A1, FN FAL, FN FNC, MP38, MP40, and SIG 550 firearms, and HK machineguns and semiautomatic variants:

The receiver is the upper part of the weapon that provides housing for the bolt.

Figure 9 to paragraph (a)(4)(ix)



x. Sten, Sterling, and Kel-Tec SUB-2000 firearms:

The receiver is the central part of the weapon, or tube, that provides housing for the bolt.

**b. Firearm muffler or silencer frame or receiver.**

The terms “frame” and “receiver” shall mean, in the case of a firearm muffler or firearm silencer, the part of the firearm, such as an outer tube or modular piece, that provides housing or a structure for the primary internal component designed to reduce the sound of a projectile ( i.e., baffles, baffling material, expansion chamber, or equivalent). In the case of a modular firearm muffler or firearm silencer device with more than one such part, the terms shall mean the principal housing attached to the weapon that expels a projectile, even if an adapter or other attachments are required to connect the part to the weapon. The terms shall not include a removable end cap of an outer tube or modular piece.

**c. Partially complete, disassembled, or nonfunctional frame or receiver.**

The terms “frame” and “receiver” shall include a partially complete, disassembled, or nonfunctional frame or receiver, including a frame or receiver parts kit, that is designed to or may readily be completed, assembled, restored, or otherwise converted to function as a frame or receiver, i.e., to house or provide a structure for the primary energized component of a handgun, breech blocking or sealing component of a projectile weapon other than a handgun, or internal sound reduction component of a firearm muffler or firearm silencer, as the case may be. The terms shall not include a forging, casting, printing, extrusion, unmachined body, or similar article that has not yet reached a stage of manufacture where it is clearly identifiable as an unfinished component part of a weapon ( e.g., unformed block of metal, liquid polymer, or other raw material). When issuing a classification, the Director may consider any associated templates, jigs, molds, equipment, tools, instructions, guides, or marketing materials that are sold, distributed, or possessed with the item or kit, or otherwise made available by the seller or distributor of the item or kit to the purchaser or recipient of the item or kit. The following are nonexclusive examples that illustrate the definitions:

**EXAMPLE 1 TO PARAGRAPH (C)—FRAME OR RECEIVER:**

A frame or receiver parts kit containing a partially complete or disassembled billet or blank of a frame or receiver that is sold, distributed, or possessed with a compatible jig or template is a frame or receiver, as a person with online instructions and common hand tools may readily complete or assemble the frame or receiver parts to function as a frame or receiver.

**EXAMPLE 2 TO PARAGRAPH (C)—FRAME OR RECEIVER:**

A partially complete billet or blank of a frame or receiver with one or more template holes drilled or indexed in the correct location is a frame or receiver, as a person with common hand tools may readily complete the billet or blank to function as a frame or receiver.

**EXAMPLE 3 TO PARAGRAPH (C)—FRAME OR RECEIVER:**

A complete frame or receiver of a weapon that has been disassembled, damaged, split, or cut into pieces, but not destroyed in accordance with paragraph (e), is a frame or receiver.

**EXAMPLE 4 TO PARAGRAPH (C)—NOT A RECEIVER:**

A billet or blank of an AR-15 variant receiver without critical interior areas having been indexed, machined, or formed that is not sold, distributed, or possessed with instructions, jigs, templates, equipment, or tools such that it may readily be completed is not a receiver.

**EXAMPLE 5 TO PARAGRAPH (C)—NOT A RECEIVER:**

A flat blank of an AK variant receiver without laser cuts or indexing that is not sold, distributed, or possessed with instructions, jigs, templates, equipment, or tools is not a receiver, as a person cannot readily fold the flat to provide housing or a structure for the primary component designed to block or seal the breech prior to initiation of the firing sequence.

**d. Multi-piece frame or receiver.**

The term “multi-piece frame or receiver” shall mean a frame or receiver that may be disassembled into multiple modular subparts, i.e., standardized units that may be replaced or exchanged. The term shall not include the internal frame of a pistol that is a complete removable chassis that provides housing for the energized component, unless the chassis itself may be disassembled. The modular subpart(s) identified in accordance with § 478.92 with an importer's or manufacturer's serial number shall be presumed, absent an official determination by the Director or other reliable evidence to the contrary, to be part of the frame or receiver of a weapon or device.

**e. Destroyed frame or receiver.**

The terms “frame” and “receiver” shall not include a frame or receiver that is destroyed. For purposes of these definitions, the term “destroyed” means that the frame or receiver has been permanently altered such that it may not readily be completed, assembled, restored, or otherwise converted to function as a frame or receiver. Acceptable methods of destruction include completely melting, crushing, or shredding the frame or receiver, or other method approved by the Director.

**f.**

**1. FRAME OR RECEIVER CLASSIFICATIONS BASED ON WHICH PART OF THE WEAPON WAS CLASSIFIED AS SUCH BEFORE APRIL 26, 2022.**

Except as provided in paragraph (f)(2) of this section, the terms “frame” and “receiver” shall include the specific part of a complete weapon, including variants thereof, determined (classified) by the Director to be defined as a firearm frame or receiver prior to April 26, 2022. Any such part that is identified with an importer's or manufacturer's serial number shall be presumed, absent an official determination by the Director or other reliable evidence to the contrary, to be the frame or receiver of the weapon. The following is a nonexclusive list of such weapons and the specific part determined by the Director to be the firearm frame or receiver as they existed on that date:

**i. AR-15/M-16 variant firearms:**

The receiver is the lower part of the weapon that provides housing for the trigger mechanism and hammer ( i.e., lower receiver).

Figure 11 to paragraph (f)(1)(i)

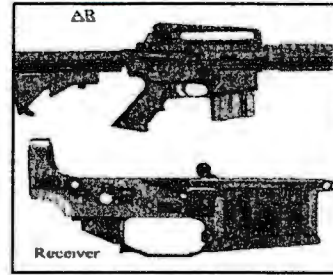

ii. **Ruger Mark IV pistol:**

The frame is the upper part of the weapon that provides housing for the bolt or breechblock.

Figure 12 to paragraph (f)(1)(ii)

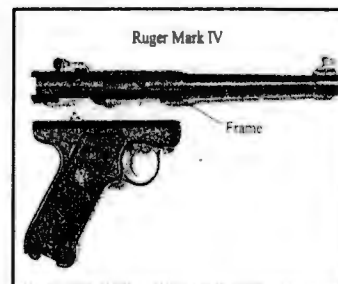

iii. **Benelli 121 M1 Shotgun:**

The receiver is the lower part of the weapon that provides housing for the trigger mechanism.

Figure 13 to paragraph (f)(1)(iii)

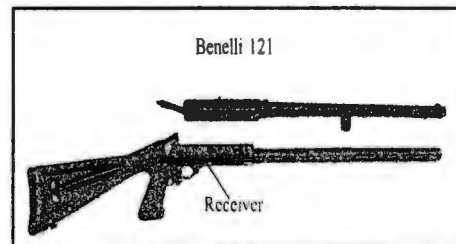

iv. **Vickers/Maxim, Browning 1919, M2, and box-type machineguns and semiautomatic variants:**

The receiver is the side plate of the weapon that is designed to hold the charging handle.

Figure 14 to paragraph (f)(1)(iv)

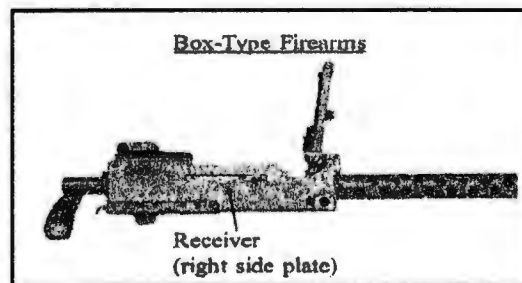



**2. FRAME OR RECEIVER CLASSIFICATIONS OF PARTIALLY COMPLETE, DISASSEMBLED, OR NONFUNCTIONAL FRAMES OR RECEIVERS BEFORE APRIL 26, 2022.**

Prior determinations by the Director that a partially complete, disassembled, or nonfunctional frame or receiver, including a parts kit, was not, or did not include, a “firearm frame or receiver” under § 478.11, or “frame or receiver” under § 479.11 of this subchapter, as those terms were defined prior to April 26, 2022, shall not continue to be valid or authoritative after that date. Such determinations shall include those in which the Director determined that the item or parts kit had not yet reached a stage of manufacture to be, or include, a “firearm frame or receiver” under § 478.11, or “frame or receiver” under § 479.11 of this subchapter, as those terms were defined prior to April 26, 2022.

# Exhibit B-8

DEPOSITION  
EXHIBIT  
S

# Shooter's Bible<sup>®</sup> GUIDE TO AR-15s

2<sup>nd</sup> EDITION



- Photos, specifications, and prices
- Hundreds of models
- Sights, scopes, and accessories
- Details of the newest guns and options

**Doug Howlett  
and Robb Manning**  
Foreword by Tiger McKee

Copyright © 2016 by Doug Howlett and Robb Manning

Foreword copyright © 2016 by Tiger McKee

All rights reserved. No part of this book may be reproduced in any manner without the express written consent of the publisher, except in the case of brief excerpts in critical reviews or articles. All inquiries should be addressed to Skyhorse Publishing, 307 West 36th Street, 11th Floor, New York, NY 10018.

Skyhorse Publishing books may be purchased in bulk at special discounts for sales promotion, corporate gifts, fund-raising, or educational purposes. Special editions can also be created to specifications. For details, contact the Special Sales Department, Skyhorse Publishing, 307 West 36th Street, 11th Floor, New York, NY 10018 or [info@skyhorsepublishing.com](mailto:info@skyhorsepublishing.com).

Skyhorse® and Skyhorse Publishing® are registered trademarks of Skyhorse Publishing, Inc.®, a Delaware corporation.

Visit our website at [www.skyhorsepublishing.com](http://www.skyhorsepublishing.com).

10 9 8 7 6 5 4 3

Library of Congress Cataloging-in-Publication Data is available on file.

Cover design by Brian Peterson

Print ISBN: 978-1-5107-1-097-9

Ebook ISBN: 978-1-5107-1-098-6

Printed in China



# CONTENTS

FOREWORD	8
INTRODUCTION	9
<b>CHAPTER 1</b> HISTORY	<b>14</b>
<b>CHAPTER 2</b> BREAKING DOWN THE AR	<b>20</b>
<b>CHAPTER 3</b> NEW RIFLES	<b>30</b>
<b>CHAPTER 4</b> AR RIFLE MODELS	<b>51</b>
<b>CHAPTER 5</b> D-I-Y RIFLES	<b>176</b>
<b>CHAPTER 6</b> OUTFITTING YOUR RIG	<b>185</b>
<b>CHAPTER 7</b> THE SPORTING AR	<b>203</b>
<b>CHAPTER 8</b> AR RIFLES: ULTIMATE HOME DEFENSE	<b>211</b>
<b>CHAPTER 9</b> WHAT THE FUTURE HOLDS	<b>219</b>
<b>APPENDICES</b>	
<b>APPENDIX I</b> AR MANUFACTURERS	<b>225</b>
<b>APPENDIX II</b> AMMUNITION MANUFACTURERS	<b>227</b>
<b>APPENDIX III</b> OPTICS AND SIGHTS MANUFACTURERS	<b>228</b>
<b>APPENDIX IV</b> AR ACCESSORIES AND SUPPLIERS	<b>229</b>
<b>ACKNOWLEDGMENTS</b>	<b>230</b>

# 1. History of the AR

For all of its popularity among the military, law enforcement and civilian shooters today, the AR-15 almost never happened. Or at the very least, its development was almost grounded before it really got the chance to fly. Dissatisfied with the overall performance of the M14 rifle that was in service at the time, the Army in the 1950s sought the assistance of commercial gun manufacturers in developing a .22-caliber firearm capable of replacing it in combat.

As the military had crossed the bridge from a post-World War II era, the focus of many of the branches was on devising tactics, equipment and machinery capable of countering the nuclear capabilities of our new age Cold War enemies. Partially responsible for this task within the U.S. Army was the Operations Research Office, created after World War II. However, the ORO increasingly found itself attempting to solve non-nuclear related challenges prompted by our country's engagement in North Korea. One such concern, recounted in the late Edward C. Ezell's book, *The Great Rifle Controversy*, one of the most detailed and comprehensive examinations of military small arms development in the United States between the close of World War II and the early 1980s, was that "ORO investigators discovered that very little was known about the nature of inflicting wounds on the human body in combat."

As a result, the Infantry Division of ORO began to study the issue by analyzing more than 3 million casu-

alties from World Wars I and II, as well as those that had occurred in Korea up to that point. For the first time, an analysis suggested that more soldiers were killed by randomly dispersed fire than carefully aimed shots, suggesting that a light-recoiling rifle that could rapidly launch multiple projectiles in a controlled, yet simultaneously spread pattern, could ultimately be more effective on the battlefield.

Following several years of studying the idea, the Continental Army Command (CONARC) decided to seek the development of a 5.56mm rifle. They reached out to both Winchester, owned by Olin, which now only manufactures the ammunition under that brand, and the ArmaLite Division of Fairchild Engine & Airplane Corp., which today is simply known as ArmaLite Inc. (But ironically no longer owns the trademark for the actual AR-15 name. More on that in a moment.)

## ARMALITE'S NEW CONCEPT RIFLE

According to a history of ArmaLite, Inc., recognizing that there had been little done in the way of advancing fundamental small arms design and function in the past 50 years, Fairchild executives president Richard S. Boutelle, a gun enthusiast, and Paul S. Cleveland, corporate secretary, wanted to focus on developing fine sporting arms for the commercial market with the hope that their work would catch the eyes of military leaders and provoke some interest. However, shortly after establishing the ArmaLite Division, the company was

HISTORY OF THE AR



Today's M4, an AR variant, is the top choice among many of our nation's military. Photo Credit: DoD Photos



invited by the U.S. Air Force to submit a rifle design that would replace the branch's survival rifle. Within a matter of weeks, ArmaLite submitted a rifle dubbed the AR-5 to the Air Force for evaluation. The rifle was built around the .22 Hornet. The Air Force adopted the rifle, which was officially designated the MA-1 Survival Rifle. This success forced the company to rethink its original decision to pursue the commercial market and instead, they changed course and focused exclusively on developing arms for the military.

From there, three people involved with ArmaLite came together to alter the course of modern firearms as we know them. According to ArmaLite, it was the idea of George Sullivan, a chief patent counsel for Lockheed Aircraft Corporation, to use the "latest technical advances in plastics and alloys" to build firearms that were lighter and more functional than then-available models. In fact, Sullivan, a tinkerer himself, had begun work on some of his ideas in his garage following World War II. Charles Dorchester directed and coordinated all of ArmaLite Division's development programs and would later go on to run the entire company. But perhaps most recognizable of the three whom would go on to change history and the one historical scholars credit for the birth of the AR platform was Eugene Stoner. Stoner, who had served as a Marine during the war and was considered an ordnance expert, was made chief engineer of the ArmaLite Division in 1954. He had been working on developing small arms independently since the war as well. It is Stoner's patents that "form the basis of much of ArmaLite's work," according to the company's historical records.

In 1955, the Army was looking to update or replace the service rifle of the time, the M1 Garand, and were considering two versions: Springfield Armory's T-44, merely an updated version of the Garand, and

the T-48, a version of the 7.62x51mm FN FAL, which was developed and manufactured by Fabrique Nationale de Herstal, known today primarily as FN Herstal. The FAL would ultimately go on to be adopted by as the primary service rifle used by many NATO coun-

tries including Belgium, Great Britain, Canada and Australia.

To compete with these firearms, Stoner took a totally new approach in firearms design of the day and created the AR-10. The first version of the AR-10 was made with aircraft grade aluminum receivers, keeping the weight down considerably from what it looked like it might weigh. In fact, empty, the rifle weighed less than 7 pounds. The receivers could be made from such lightweight material because the bolt locked into a steel extension that attached to the barrel, not directly in the receiver itself. Stocks, pistol grips and fore-ends were all plastic compared to the wood-grain furniture more common to guns of the day. Unfortunately, despite capturing the attention of more than a few military leaders intrigued by the firearm's unique design, the ArmaLite Division had gotten involved too late to adequately compete. An article that first appeared in the May 1962 issue of *American Rifleman* magazine noted that the initial AR-10 had also fallen prey to flaws with its original composite steel-aluminum barrel and a complicated flash suppressor.

According to Ezell, however, of those leaders intrigued by the AR-10's design included CONARC's commander, Gen. Willard G. Wyman. In 1957, Wyman personally asked Stoner to design a 5.56mm rifle for the Army similar to the AR-10. That scaled-down rifle would go on to become the AR-15.

The first AR-15s had steel barrels and an Army-developed BAR-type flash suppressor. And while Stoner's design has been called genius by many, the real genius may have been found in the engineer's ability to borrow features from a number of popular and proven European gun designs and combine them

⌘ In the form of the M16, the AR made its way into the hands of our military by 1963. Photo Credit: DoD Photos



⌘ Eugene Stoner, creator of the AR design.



HISTORY OF THE AR



in a single platform. The now-ubiquitous hinge design of the AR, not unlike that of a break-open shotgun, was similar to a design used in the Czech ZH or ZB 29 rifle and adopted in the FN. The rear sight was built into the rear of the carrying handle like the British EM 2, the hinged cover on the ejection port resembled that of the German Sturmgewehr 44, the locking system was similar to the one used in the Johns Semiautomatic Rifle from the 1940s and the straight stock, designed to better accommodate recoil and manage multiple shots, was similar to a number of auto and semi-auto rifle designs getting some play at the time, including as Ezell pointed out, the Harvey T25.

Stoner's gas operating system, which employed, and still does on direct impingement ARs, a tube beneath the front sight and directed gas back to the bolt in order to cycle rounds during firing, had been used in the both Swedish M42 Ljungman and the French MAS 1949.

"Stoner's achievement in the AR-15 was the combination of all of these ideas into an attractive package," wrote Ezell. Of course, once designed, the rifle still had to win favor with the military, a battle that almost ended the AR-15's prominent role in history right there.

To begin, ArmaLite was so small, it didn't have a full research facility or the staff to completely develop a fully tested prototype. Instead, they had to rely on military testers, many whom had their own prejudices against this new weapon and did it few favors to discover if it could actually serve soldiers well. There were some key leaders in the Army who simply didn't like the fact that the new gun hadn't been developed within the branch's own usual channels. Others simply didn't like the new configuration of the gun, much as some traditional-minded hunters view the firearm even today. Rain tests conducted on a test sample of the rifles originally suggested that shooting the guns with water in the barrels could result in burst barrels—something that was believed at the time to be "characteristic of high-velocity rifles having a bore diameter of less than .25 caliber," according to Ezell. ArmaLite strengthened the barrels in response, but still concerns over the hazard persisted. Arctic tests conducted on the rifles to determine how they would perform in freezing weather also proved disappointing to testers, though the Winchester .224 rifle still being considered

at the time also failed in this respect. In the end, the test board reviewing the new rifles suggested that a ".223 (5.56mm) round was not a suitable replacement for the 7.62 NATO round" and that development of a heavier .258 caliber (6.35mm) cartridge be pursued (Ezell). In light of the recommendations, Army Chief of Staff Gen. Maxwell Taylor ruled the branch would continue procuring the heavier and already NATO approved 7.62 M14 rifles.

## SECOND CHANCE

After all of the expense in developing the AR-15, it was a tough financial blow to a small company like Fairchild, which, struggling to make ends meet, had actually already begun to search for a company to which to license the production of both the AR-15 and the AR-10. The company had invested in the AR-15 project alone \$1.45 million, an amount that by today's corporate standards would be fairly cheap but for any small company, then or now, could be a backbreaker. Fairchild decided to recoup some of the costs of the protracted project by selling the manufacturing and marketing rights to what was then called Colt's Patent Firearms Manufacturing Company, but is better known today simply as Colt's Manufacturing, LLC, or merely Colt. The company bought the rights to both firearms (a version of the AR-10 had already been sold to the Dutch and was being marketed in Southeast Asia where conflicts were erupting in what was then a little-known country called Vietnam) for \$75,000 cash payment and a guarantee of a 4 ½ percent royalty on all future sales.

In *The Black Rifle: M16 Retrospective* by R. Blake Stevens and Edward C. Ezell, the authors note that at the time, Colt was also suffering financially as a result of dried up military and civilian markets following WWII. The company also hadn't retooled its manufacturing facilities in nearly a century. The Maryland-based firm of Cooper-MacDonald, which through one of its principles, Robert W. "Bobby" MacDonald already promoted the Dutch AR in Southeast Asia, worked with both ArmaLite and Colt and had been the connection that brought the sale of the ARs together. Interestingly, Cooper-MacDonald made more off the sale of the guns to Colt than





⤴ The first true military version of the AR-15, the M16, got its first full trial during the Vietnam War. Photo Credit: DoD Photos

Fairchild, netting \$250,000 and a 1 percent royalty on all future guns sold.

MacDonald, who had extensive contacts in Southeast Asia and saw the AR-15 as an ideal gun for the “smaller statured” fighters of the region, immediately began marketing the gun in that part of the world and, under orders from Colt, to the U.S. military once again. They wanted to see the AR-15 given another chance.

Initially Army representatives refused. But Colt had better luck when they decided to bypass the branch and seek other military buyers. Ultimately, Air Force Vice Chief of Staff Gen. Curtis LeMay, who witnessed a demonstration of the guns, suggested that the Air Force test the AR-15 as a replacement for the M2 carbines used by its sentries. The tests proved positive and the Air Force placed an initial order for 8,500 rifles (Ezell). Sometimes it just takes that one lucky break to get the door to open wider than your foot and allow you to walk on through.

Studies by the Defense Department, who agreed to give the gun another look, also proved favorable, causing questions to be asked all the way up the chain of command as to why the disparity between the Army's original findings and the reports coming out about the gun then. Indeed, both Secretary of Defense Robert McNamara and even then President John F. Kennedy had questions. Ultimately, the Army was forced to reevaluate the rifle the result being in 1963 that the

decision was made to end procurement of the M14. At the same time, McNamara ordered the purchase of 85,000 AR-15s for the Army and 19,000 for the Air Force, who was already using some of the guns, to begin the following year (Ezell).

The purchase was initially intended to be a one-time deal—enough to fill the gap until another weapons testing program was complete and a new firearm developed, but history proves that did not become the case. To meet demand for the growing conflict in Vietnam, the Army ordered more of the rifles and reclassified it as the M16.

## NOT DONE YET

Once the AR-15/M16 made its way to soldiers' hands and was finally being tested on the battlefield, problems began to arise. While the overall opinion was that most soldiers liked the overall design and concept of the rifle, its immediate popularity was hindered by a few problems operators encountered in the field—mainly the gun malfunctioning during combat. Reviews revealed several causes for this including ammunition that didn't function properly in the rifle because of its high-residue powder. The Army had insisted on a faster-burning ball-type powder for use in the field instead of the cleaner burning powder Stoner had used in developing the rifle because they wanted





⚡ While the design of the M16 was generally well received by Vietnam-era soldiers, the model was not without its problems, primarily malfunctions when dirty.

to generate higher muzzle velocities. The Army also failed to secure chrome-lined barrels and chambers in the rifles, which resisted heat and fouling better as well as corrosion and pitting. Perhaps most egregiously ignored was the lack of proper cleaning supplies and quite simply a failure to properly train troops with the new rifle and enforce its frequent cleaning.

In fact, according to former long-distance AR competition shooter John Murphy, who has shot ARs extensively and studied their history, the original M16 was originally billed as a gun that didn't require much care or cleaning.

"The chamber on the .223 was not chrome plated. It got so hot that cases were sticking and with all of the gunk and powder, the gun would jam up," says Murphy. "The gun was marketed as one that didn't need cleaning, which was bunk. You have to always clean a gun." The cleaning of magazines was also found to be crucial as they would fill with grime and quit feeding rounds into the chamber during firing. Indeed when asked about how often he cleaned his M4, the military's modern, shorter version of the original M16 design, one recently retired Navy SEAL who has seen action in both Afghanistan and Iraq, said simply "every chance you get. Your life depends on it."

As more troops began carrying the new rifle into Vietnam, training and cleaning procedures—for both the rifle and its magazine—improved and with it, fewer reports of malfunctioning guns. In fact, the lack of proper cleaning seemed to fix much of what the initial concerns about the M16 were. Improvements in the propellant used in the military-issued ammunition also reduced reports of problems with the guns.

Over the years, the gun design has undergone a number of improvements and variations as requested by various branches of the military—and even by some civilian engineers and shooters—including the addition of: a forward assist, to aid in locking the bolt forward in rare instances when it fails to do so; flat-top receivers; heavier barrels; adjustable windage rear sights; selector switch functions that reduced full-auto firing to the firing of three-round bursts; a gas piston operating system as an option to the direct impingement design; and other minor tweaks including adjustments in stock length, thickness of barrels and stock design and functionality. Where the military design has wandered, the civilian market has followed.

One of the most notable changes in the rifle over time occurred with its rifling. Original models often had a 1-in-14-inch (1:14) or 1-in-12-inch (1:12) twist for use with the lighter 55-grain bullets used for combat at the time. This worked great for shooting targets under 300 yards and indeed, most combat engagement occurred at 100 yards or less, most often due to terrain features and limitations more so than an inability of the shooter. However, for long range shooting—ranges of out to 600 yards as was required in high-power competition matches or sniping—the gun was inadequate.



⚡ Today, popularity of the AR among hunters is one of the driving forces behind the platform's high sales numbers.

HISTORY OF THE AR



To improve the M16's early performance, rifling in the barrel was changed to a 1:7 twist in order to better accommodate 62-grain bullets. >>

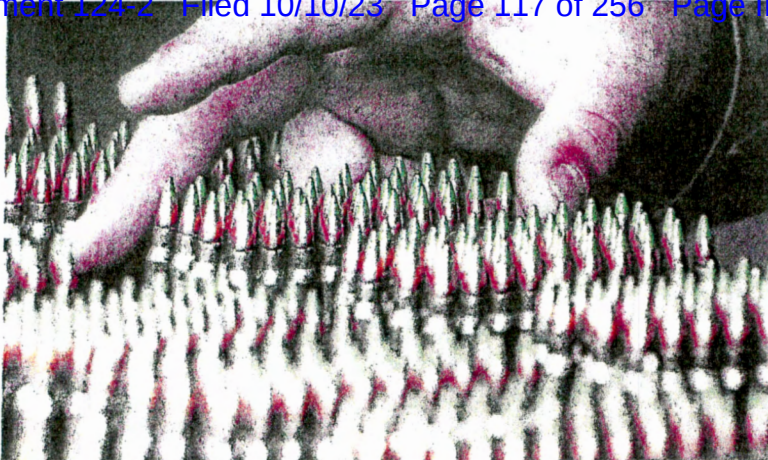

The 1:12 twist was unable to stabilize longer, heavier bullets needed for long distance shooting.

In "The Making of a Match Rifle," originally published in the July 1999 issue of *American Rifleman* by former Shooting Editor Glenn M. Gilbert, the author recounts how improvements in this area evolved following the adoption by NATO of a standard 5.56mm round loaded with a heavier 62-grain bullet, and which was fired from a barrel with a 1:9 twist. That bullet was designed by FN. In response, "the Army quickly developed a copy of the 62-grain FN bullet and standardized it as the M855 in 1981."

The rifling in the barrel of M16 was soon tightened to a 1:7 twist in order to accommodate the heavier bullet as well as tracers that were planned for the newly rifled firearms. Over time, the twist rate and development of longer bullets in the 77-grain and 80-grain arena solved the long range dilemma and produced a rifle that both military sharpshooters and civilian competitors could come to rely on. And indeed, once those problems were solved, the AR became a preferred gun of many competitors such as John Murphy.

"The Marines were the first ones to successfully carry the ARs to Camp Perry in 1994, and they cleaned everyone's clock with the new twist rates and the longer bullets," says Murphy.

Gilbert sums the AR's evolution up in his article by writing, "The AR-15 has come a long way. Long derided as a plastic toy, it is now the benchmark in accuracy among semi-auto rifles." It is this mix of both short-range application and long-range accuracy, combined with the multiple levels of personalization and functionality that have many experts predicting that the heyday of the AR is indeed here.

This sentiment, in fact, is continuing forward along dual paths. While there are a number of competing—and darn good—tactical rifle platforms available (the FN SCAR, HK416 and SIG 556xi are just a few that come immediately to mind), the U.S. Army, after a

multi-year effort to find a suitable replacement for the M4 recently decided to scrap the search and commit to converting the M4 to M4A1s. The M4, successor variant of the M16, with a shorter barrel, flat top, collapsible stock and less weight, has been in use since 1994. While it has received periodic upgrades over the years, the transition to the M4A1, with a heavier barrel, full-auto firing capability and ambidextrous controls, is underway and should be complete by 2020 according to reports by the *Army Times*. From a military perspective at least, this move cements the continuation of the AR's place as the weapon of choice for many of our nation's servicemen and women on the battlefield.

Despite criticisms of the platform's ability to perform without malfunctioning in sandy or dirty environments, an *Army Times* article cites testing data that showed "today's M4 and M4A1 indicate a 98.3 percent probability of completing a mission with a basic ammunition load (209 rounds) without failure." To those supporters cheering on a new small-arms alternative to the AR, the Army scrapped the effort to find a replacement after determining that all of the potential replacements didn't provide sufficient improvements over current performance levels . . . particularly not enough to justify the additional cost it would take to swap out the entire branch's shoulder-fired weapons.

On the civilian front, increasing acceptance by competitive shooters, driven in large part by 3Gun competitors, and certainly hunters, who continue to embrace the platform, are driving high-end performance features on some models and more hunt-friendly features and broader caliber offerings on others. This latter development has been one of the most visible in recent years as manufacturers seek to keep rifles moving off shelves even as buying patterns settle into more stable, yet realistic numbers following the boom years of 2008–09 and 2012–13. But more on that later in the book.



## 4. AR Rifle Models

Following is undoubtedly the most comprehensive listing of current AR-style rifle models available in print or on the web, though it is by no means exhaustive. The knowledgeable reader will no doubt find a favorite small manufacturer or favorite model of gun not listed here. Some companies simply have so many guns, it was impractical to list them all. Others were, for inexplicable reasons other than they were too busy, unable to respond to the authors' requests for information and photography, didn't have adequate information available on their websites (some had no websites) or they themselves didn't even have detailed information on their firearm models available. And admittedly, with so many small gunmakers coming into the fold—and just as quickly falling back out of it, capturing every manufacturer is a target even a custom-built AR couldn't hit.

Speaking of custom builders, many, if they did not make predetermined firearm packages, were not included, but are listed in appendices of this book. Likewise, even AR manufacturers whose firearms are not listed in this chapter are at least listed in an appendix at the back of this book. Please check out GuidetoARs.com frequently for updates on gun listings that were missed in this book, previews of new ARs and accessories coming to the market, tips on getting better performance out of your rifle and for detailed reviews on new AR models coming to a store shelf near you. Also, if you are an AR manufacturer and were not listed, please make us aware of your company and its offerings. Contact us through GuidetoARs.com where we will be happy to include your gun models or accessories and will know how to reach you more directly when working on the next edition of *The Shooter's Bible Guide to AR-15s*.

### 2VETS ARMS 2VA BRAVO

**Action:** semi-auto  
**Stock:** B5 Systems  
**Barrel:** 16-in. 4140 CMOV barrel, 1:7  
**Sights:** A2 front sight base  
**Weight:** N/A  
**Caliber:** .556  
**Magazine:** N/A  
**Features:** Arms 7075-T6 billet side charged upper receiver.  
**MSRP:** ..... \$1,300

### 2VA SOPMOD

**Action:** semi-auto  
**Stock:** B5 Systems  
**Barrel:** 16-in. 416R stainless steel barrel, 1:7 RH twist  
**Sights:** N/A  
**Weight:** N/A  
**Caliber:** 5.56  
**Magazine:** N/A  
**Features:** 7075-T6 billet side charged upper receiver, 7075-T6 billet lower receiver, ALG Defense GI fire controls, carbine gas system, 10-in. quad rail.  
**MSRP:** ..... \$1,499

### 2VA NATO GENESIS SERIES

**Action:** semi-auto  
**Stock:** B5 Systems  
**Barrel:** 13.7-in. barrel, B.E. Meyers 249 flash hider  
**Sights:** N/A  
**Weight:** N/A  
**Caliber:** .556  
**Magazine:** N/A  
**Features:** 2VA 7075 billet A4 upper, 2VA 7075 billet lower, ambi charging handle, M-LOK rail.  
**MSRP:** ..... \$1,575

### 2VA .308 SPECIAL PURPOSE RIFLE

**Action:** semi-auto  
**Stock:** B5 Systems Bravo  
**Barrel:** 18-in., 1:10 RH twist, full fluted 416R stainless match-grade barrel w/ black Nitride finish  
**Sights:** N/A  
**Weight:** 7 lb. 13 oz.  
**Caliber:** .308  
**Magazine:** N/A  
**Features:** 7075-T6 matched set billet receivers, ambidextrous side charging system, ambidextrous safety selector,

two-stage trigger from Geissele Automatics (G2S-E), B5 Systems Bravo collapsible buttstock, 14-in. P3R lightweight free-float rail, 18-in. full fluted 416R stainless match-grade barrel with black Nitride finish.  
**MSRP:** ..... \$1,875

### 2VA ALPHA

**Action:** semi-auto  
**Stock:** B5 SOPMOD Alpha stock, BCM Gunfighter grip  
**Barrel:** 16-in. 416R stainless steel match barrel with full flutes  
**Sights:** N/A  
**Weight:** N/A  
**Caliber:** 5.56  
**Magazine:** N/A  
**Features:** Arms 7075-T6 billet side charged upper receiver, 7075 forged lower receiver, mid-length gas system, Geissele SSA fire controls, KNS anti-rotation pins, Battle Arms Development ambi selector, Phase 5 enhanced side charged compatible BAD lever, 13-in. KeyMod compatible free-float rail.  
**MSRP:** ..... \$1,875

AR RIFLE MODELS



# APPENDIX I—AR MANUFACTURERS

2 Vets Arms  
www.2vetsarms.com

556 Tactical LLC  
www.556tactical.com

**A**  
Accurate Armory  
www accuratearmory.com

Adams Arms  
www.adamsarms.net

Adcor Defense  
www.adcordefense.com

Aero Precision  
www.Aeroprecisionusa.com

Alexander Arms  
www.Alexanderarms.com

Alex Pro Firearms  
www.apfarmory.com

American Spirit Arms  
www.americanspiritarms.com

American Tactical Imports  
www.americantactical.us

American Firearms Manufacturing  
www.afmco.com

Anderson Manufacturing  
www.andersonrifles.com

AR57 Center  
www.57center.com

Ares Arms  
www.aresarms.com

Ares Defense  
www.aresdefense.com

Arsenal Democracy  
www.arsenaldemocracy.com

ArmaLite  
www.armacite.com

Armscor  
www.armscor.com

Arms Tech Ltd  
www.armstechltd.com

Astra Arms  
www.astra-arms.ch

AXTS Weapons  
www.axtsweapons.com

**B**  
Barnes Precision  
www.usamade-ar15parts.com

Barrett  
www.barrett.net

Battle Born  
www.battlebornusa.com

Battle Rifle Company  
www.battleriflecompany.com

Bazooka Brothers  
www.bazookabrothers.com

BCI Defense  
www.bcidefense.com

Black Heart International  
www.bhigear.com

Black Rain Ordnance  
www.blackrainordnance.com

Black Dawn Armory  
www.blackdawnarms.com

Bradley Arms  
www.bradleyarms.com

Bravo Company USA  
www.bravocompanyusa.com

Bushmaster  
www.bushmaster.com

**C**  
Chattahoochee Gun Works  
www.c-gw.com

Christensen Arms  
www.christensenarms.com

Christian Armory Works  
www.christianarmoryworks.com

CMMG  
www.cmmginc.com

Colt Competition Rifles  
www.coltcompetitionrifle.com

Colt Firearms  
www.colt.com

Compass Lake Engineering  
www.compasslake.com

**D**  
Daniel Defense  
www.deztacticalarms.com

Del-Ton  
www.del-ton.com

DEZ Tactical  
www.deztacticalarms.com

Diamondback Firearms  
www.diamondbackfirearms.com

Double Star  
www.star15.com

DPMS  
www.dpmsinc.com

Dragon Fire Armory  
www.dragonfirearmory.com

Dreadnaught Industries  
www.dreadnaught-industries.com

DSA Arms  
www.dsarms.com

**E**  
Edward Arms  
www.edwardarms.com

Erathr3  
www.erathr3.com

**F**  
Firebird Precision  
www.firebirdprecision.com

Fulton Armory  
www.fulton-armory.com

FNH USA \*\*\*Now FN America\*\*\*\*  
www.fnamerica.com

Franklin Armory  
www.franklinarmory.com

**G**  
GAR Arms  
www.gar-arms.com

**H**  
Hatcher Gun Company  
www.hatchergun.com

Head Down Products  
www.hdfirearms.com  
Hera Arms  
www.hera-arms.com

High Standard Firearms  
www.highstandard.com

HM Defense  
www.hmdefense.com

Heckler & Koch  
www.hk-usa.com

Hogan Guns  
www.hoganguns.com

Huldra Arms  
www.huldraarms.com

**I**  
Integrity Arms  
www.customar15.net

Invincible Arms  
www.invinciblearms.com

Iron Ridge Guns  
www.ironridgeguns.com

**J**  
JARd, Inc.  
www.jardinc.com

Jesse James Firearms  
www.jjfu.com

JP Rifles  
www.jp Rifles.com

**K**  
Kaufmann Tactical Firearms  
www.kt-firearms.com

KE Arms  
www.kearms.com

Knights Armament  
www.knightarmco.com

**L**  
Lancer Systems  
www.lancer-systems.com

Larue Tactical  
www.larue.com

Les Baer  
www.lesbaer.com

Lewis Machine and Tool  
www.lewismachine.net

LWRC  
www.lwrci.com

**M**  
MGI Military  
www.mgi-military.com

MHT Defense  
www.mhtdefense.com

Midwest Industries  
www.midwestindustriesinc.com

MMC Armory  
www.mmcamory.com

Mohawk Armory  
www.mohawkarmory.com

Mossberg  
www.mossberg.com

**N**  
NEMO Arms  
www.nemoarms.com

Noveske Rifleworks  
www.noveske.com

**O**  
Olympic Arms  
www.olyarms.com

**P**  
Palmetto State Defense  
www.palmettostatedefense.com

Patriot Ordnance Factory (POF)  
www.pof-usa.com

PEC Armory  
www.pecarmory.com

Personal Defense Warehouse  
www.pdwarehouse.com

Precision Firearms  
www.precisionfirearms.com

Precision Reflex  
www.precisionreflex.com

Primary Weapons Systems  
www.primaryweapons.com

**Q**  
Quality Arms  
www.qualityarmsidaho.com

Quentin Defense  
www.quentindefense.com

**R**  
Radical Firearms  
www.radicalfirearms.com

Ranger Proof  
www.rangerproof.com

Rebel Arms  
www.rebelarms.com

Red X Arms  
www.shop.redxarms.com

Remington Arms  
www.remington.com

R Guns  
www.rguns.net

RIP Tactical  
www.rip-tactical.com

RND Manufacturing  
www.rndrifles.com

Rock River Arms  
www.rockriverarms.com

Ruger  
www.ruger.com

**S**  
Savannah River Armory  
www.savannahriverarmory.com

Schmeisser Germany  
www.schmeisser-germany.de

Seekins Precision  
www.seekinsprecision.com

SLR15 Rifles  
www.slr15rifles.com

Sharps Rifle Company  
www.srcarms.com

SI Defense  
www.si-defense.com

Signature Manufacturing  
www.signaturemanufactures.com

Sig Sauer  
www.sigsauer.com

Sionics Weapon Systems  
www.sionicsweaponsystems.com

Smith & Wesson  
www.smith-wesson.com

Specialized Dynamics  
www.specializeddynamics.com

Specialized Tactical Systems  
www.specializedtactical.com

Spikes Tactical  
www.spiketactical.com

Stag Arms  
www.stagarms.com

Sterling Arsenal  
www.sterlingarsenal.com

Stubborn Mule Outdoor Supply  
www.smosarms.com

Surplus Ammo and Arms  
www.surplusammo.com

Superior Arms  
www.superiorarms.com

S.W.O.R.D. International  
www.sword-int.com

**T**  
Tactical Arms Manufacturer  
www.tacticalarmsmfr.com

Tactical Firearms Solutions  
www.tfsarms.com

Teppo Jutsu  
www.teppojutsu.com

Texas Black Rifle Company  
www.tbrci.com  
Texas Custom Guns

www.texascustomguns.net

Thor Global Defense  
www.thorgdg.com

TNW Firearms  
www.tnwfirearms.com

TR Enabling  
www.tr-enabling.com

Trident Arms  
www.tridentarms.us

**U**  
USA Tactical Firearms  
www.usatf.us

**V**  
Valkyrie Armament  
www.beltfedar.com

Vltor Weapon Systems  
www.vltor.com

Vidalia Police Supply  
www.kavodcustom.com

**W**  
War Sport Industries  
www.warsport-us.net

Wilson Combat  
www.wilsoncombat.com

Windham Weaponry  
www.windhamweaponry.com

**X**  
Xtreme Machining  
www.xtrememachining.biz

**Y**  
Yankee Hill Machine  
www.yhm.net

APPENDIX I



Sports/Shooting

US \$19.99/Can \$26.99

## THE MOST RECENT INFORMATION AND SPECS ON THE POPULAR AR-15 RIFLE

There's no denying the popularity and intense fascination with AR-15s among firearms enthusiasts today. Interest has grown rapidly over the past decade, spurred by the versatility of modern sporting rifles in addition to increased performance. Here, inside the most comprehensive source to date in a newly updated second edition, is Doug Howlett and Robb Manning's expert approach to everything from the intriguing history of the AR to breaking down the weapon piece by piece, choosing ammunition, and even building your own gun.

In this complete book of AR-style firearms, you can peruse the products of all manufacturers, learn about the evolution of the AR from its uses in the military in the 1960s as well as gain essential knowledge on the parts and functions of the rifle. Also included are chapters on customizing and accessorizing ARs, and much more.

**DOUG HOWLETT** is an award-winning editor and writer who grew up hunting and shooting. He began his writing career as a newspaper reporter before combining his passions for writing and the outdoors at the National Rifle Association, where he worked as assistant editor of *American Hunter* magazine. He has served as editor-in-chief of *Turkey Call* magazine at the National Wild Turkey Federation, as well as deputy editor at *Outdoor Life* magazine in New York City. It was on a hunt he covered for *Outdoor Life* that he discovered the absolute thrill of hunting with modern tactical rifles.

**ROBB MANNING** grew up in southern Wisconsin before enlisting in the US Marine Corps, where he served for nearly eleven years. During this time, he developed a passion and knowledge for firearms of all types. Robb has been writing professionally since 2010, and his work has appeared in *AR Guns & Hunting*, *Predator Xtreme*, *Gun Digest*, and *Modern Shooter*. He currently has two reoccurring columns in *On Wisconsin Outdoors* newspaper and is the author of the *Glock Quick Reference Guide* and the current editor of *Gun World* magazine.

### ALSO AVAILABLE

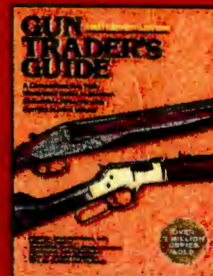
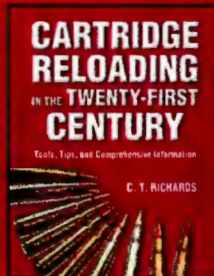
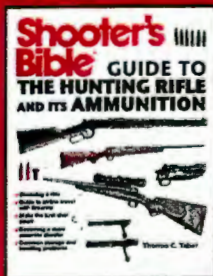
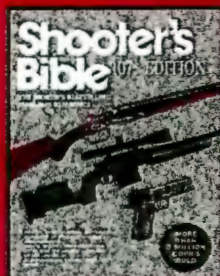

 Skyhorse Publishing, Inc.  
New York, New York  
[www.skyhorsepublishing.com](http://www.skyhorsepublishing.com)

Cover design by Brian Peterson  
Printed in China





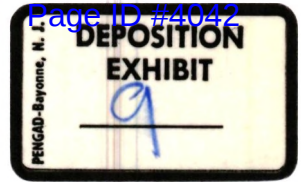

# Illinois General Assembly

Home Legislation & Laws Senate House My Legislation Site Map

Bills & Resolutions

## Illinois Compiled Statutes

Compiled Statutes

[ILCS Listing](#) [Public Acts](#) [Search](#) [Guide](#) [Disclaimer](#)

Public Acts

### Information maintained by the Legislative Reference Bureau

Legislative Reports

Updating the database of the Illinois Compiled Statutes (ILCS) is an ongoing process. Recent laws may not yet be included in the ILCS database, but they are found on this site as [Public Acts](#) soon after they become law. For information concerning the relationship between statutes and Public Acts, refer to the [Guide](#).

IL Constitution

Legislative Guide

Legislative Glossary

Because the statute database is maintained primarily for legislative drafting purposes, statutory changes are sometimes included in the statute database before they take effect. If the source note at the end of a Section of the statutes includes a Public Act that has not yet taken effect, the version of the law that is currently in effect may have already been removed from the database and you should refer to that Public Act to see the changes made to the current law.

Search By Number  
(example: HB0001)

Go [Search Tips](#)

(720 ILCS 5/24-1.9)

Sec. 24-1.9. Manufacture, possession, delivery, sale, and purchase of assault weapons, .50 caliber rifles, and .50 caliber cartridges.

(a) Definitions. In this Section:

(1) "Assault weapon" means any of the following, except as provided in subdivision (2) of this subsection:

(A) A semiautomatic rifle that has the capacity to accept a detachable magazine or that may be readily modified to accept a detachable magazine, if the firearm has one or more of the following:

- (i) a pistol grip or thumbhole stock;
- (ii) any feature capable of functioning as a protruding grip that can be held by the non-trigger hand;
- (iii) a folding, telescoping, thumbhole, or detachable stock, or a stock that is otherwise foldable or adjustable in a manner that operates to reduce the length, size, or any other dimension, or otherwise enhances the concealability of, the weapon;
- (iv) a flash suppressor;
- (v) a grenade launcher;
- (vi) a shroud attached to the barrel or that partially or completely encircles the barrel, allowing the bearer to hold the firearm with the non-trigger hand without being burned, but excluding a slide that encloses the barrel.

(B) A semiautomatic rifle that has a fixed magazine with the capacity to accept more than 10 rounds, except for an attached tubular device designed to accept, and capable of operating only with, .22 caliber rimfire ammunition.

(C) A semiautomatic pistol that has the capacity to accept a detachable magazine or that may be readily modified to accept a detachable magazine, if the firearm has one or more of the following:

- (i) a threaded barrel;
- (ii) a second pistol grip or another feature capable of functioning as a protruding grip that can be held by the non-trigger hand;
- (iii) a shroud attached to the barrel or that

Search By Keyword

Go [Search Tips](#)

[Advanced Search](#)





9/27/23, 2:54 PM

Illinois General Assembly - Illinois Compiled Statutes

partially or completely encircles the barrel, allowing the bearer to hold the firearm with the non-trigger hand without being burned, but excluding a slide that encloses the barrel;

(iv) a flash suppressor;

(v) the capacity to accept a detachable magazine at some location outside of the pistol grip; or

(vi) a buffer tube, arm brace, or other part that protrudes horizontally behind the pistol grip and is designed or redesigned to allow or facilitate a firearm to be fired from the shoulder.

(D) A semiautomatic pistol that has a fixed magazine with the capacity to accept more than 15 rounds.

(E) Any shotgun with a revolving cylinder.

(F) A semiautomatic shotgun that has one or more of the following:

(i) a pistol grip or thumbhole stock;

(ii) any feature capable of functioning as a protruding grip that can be held by the non-trigger hand;

(iii) a folding or thumbhole stock;

(iv) a grenade launcher;

(v) a fixed magazine with the capacity of more than 5 rounds; or

(vi) the capacity to accept a detachable magazine.

(G) Any semiautomatic firearm that has the capacity to accept a belt ammunition feeding device.

(H) Any firearm that has been modified to be operable as an assault weapon as defined in this Section.

(I) Any part or combination of parts designed or intended to convert a firearm into an assault weapon, including any combination of parts from which an assault weapon may be readily assembled if those parts are in the possession or under the control of the same person.

(J) All of the following rifles, copies, duplicates, variants, or altered facsimiles with the capability of any such weapon:

(i) All AK types, including the following:

(I) AK, AK47, AK47S, AK-74, AKM, AKS, ARM, MAK90, MISR, NHM90, NHM91, SA85, SA93, Vector Arms AK-47, VEPR, WASR-10, and WUM.

(II) IZHMAASH Saiga AK.

(III) MAADI AK47 and ARM.

(IV) Norinco 56S, 56S2, 84S, and 86S.

(V) Poly Technologies AK47 and AKS.

(VI) SKS with a detachable magazine.

(ii) all AR types, including the following:

(I) AR-10.

(II) AR-15.

(III) Alexander Arms Overmatch Plus 16.

- (IV) Armalite M15 22LR Carbine.

(V) Armalite M15-T.

(VI) Barrett REC7.

→ (VII) Beretta AR-70.

(VIII) Black Rain Ordnance Recon Scout.

- (IX) Bushmaster ACR.

(X) Bushmaster Carbon 15.

(XI) Bushmaster MOE series.

(XII) Bushmaster XM15.

- (XIII) Chiappa Firearms MFour rifles.

(XIV) Colt Match Target rifles.

9/27/23, 2:54 PM

Illinois General Assembly - Illinois Compiled Statutes

- (XV) CORE Rifle Systems CORE15 rifles.
- (XVI) Daniel Defense M4A1 rifles.
- (XVII) Devil Dog Arms 15 Series rifles.
- (XVIII) Diamondback DB15 rifles.
- (XIX) DoubleStar AR rifles.
- (XX) DPMS Tactical rifles.
- (XXI) DSA Inc. ZM-4 Carbine.
- (XXII) Heckler & Koch MR556.
- (XXIII) High Standard HSA-15 rifles.
- (XXIV) Jesse James Nomad AR-15 rifle.
- (XXV) Knight's Armament SR-15.
- (XXVI) Lancer L15 rifles.
- (XXVII) MGI Hydra Series rifles.
- (XXVIII) Mossberg MMR Tactical rifles.
- (XXIX) Noreen Firearms BN 36 rifle.
- (XXX) Olympic Arms.
- (XXXI) POF USA P415.
- (XXXII) Precision Firearms AR rifles.
- (XXXIII) Remington R-15 rifles.
- (XXXIV) Rhino Arms AR rifles.
- (XXXV) Rock River Arms LAR-15 or Rock River Arms LAR-47.
- (XXXVI) Sig Sauer SIG516 rifles and MCX rifles.
- (XXXVII) Smith & Wesson M&P15 rifles.
- (XXXVIII) Stag Arms AR rifles.
- (XXXIX) Sturm, Ruger & Co. SR556 and AR-556 rifles.
- (XL) Uselton Arms Air-Lite M-4 rifles.
- (XLI) Windham Weaponry AR rifles.
- (XLII) WMD Guns Big Beast.
- (XLIII) Yankee Hill Machine Company, Inc. YHM-15 rifles.
- (iii) Barrett M107A1.
- (iv) Barrett M82A1.
- (v) Beretta CX4 Storm.
- (vi) Calico Liberty Series.
- (vii) CETME Sporter.
- (viii) Daewoo K-1, K-2, Max 1, Max 2, AR 100, and AR 110C.
- (ix) Fabrique Nationale/FN Herstal FAL, LAR, 22 FNC, 308 Match, L1A1 Sporter, PS90, SCAR, and FS2000.
- (x) Feather Industries AT-9.
- (xi) Galil Model AR and Model ARM.
- (xii) Hi-Point Carbine.
- (xiii) HK-91, HK-93, HK-94, HK-PSG-1, and HK USC.
- (xiv) IWI TAVOR, Galil ACE rifle.
- (xv) Kel-Tec Sub-2000, SU-16, and RFB.
- (xvi) SIG AMT, SIG PE-57, Sig Sauer SG 550, Sig Sauer SG 551, and SIG MCX.
- (xvii) Springfield Armory SAR-48.
- (xviii) Steyr AUG.
- (xix) Sturm, Ruger & Co. Mini-14 Tactical Rifle M-14/20CF.
- (xx) All Thompson rifles, including the following:
  - (I) Thompson M1SB.
  - (II) Thompson T1100D.
  - (III) Thompson T150D.
  - (IV) Thompson T1B.
  - (V) Thompson T1B100D.

9/27/23, 2:54 PM

## Illinois General Assembly - Illinois Compiled Statutes

- (VI) Thompson T1B50D.
  - (VII) Thompson T1BSB.
  - (VIII) Thompson T1-C.
  - (IX) Thompson T1D.
  - (X) Thompson T1SB.
  - (XI) Thompson T5.
  - (XII) Thompson T5100D.
  - (XIII) Thompson TM1.
  - (XIV) Thompson TM1C.
  - (xxi) UMAREX UZI rifle.
  - (xxii) UZI Mini Carbine, UZI Model A Carbine, and UZI Model B Carbine.
  - (xxiii) Valmet M62S, M71S, and M78.
  - (xxiv) Vector Arms UZI Type.
  - (xxv) Weaver Arms Nighthawk.
  - (xxvi) Wilkinson Arms Linda Carbine.
- (K) All of the following pistols, copies, duplicates, variants, or altered facsimiles with the capability of any such weapon thereof:
- (i) All AK types, including the following:
    - (I) Centurion 39 AK pistol.
    - (II) CZ Scorpion pistol.
    - (III) Draco AK-47 pistol.
    - (IV) HCR AK-47 pistol.
    - (V) IO Inc. Hellpup AK-47 pistol.
    - (VI) Krinkov pistol.
    - (VII) Mini Draco AK-47 pistol.
    - (VIII) PAP M92 pistol.
    - (IX) Yugo Krebs Krink pistol.
  - (ii) All AR types, including the following:
    - (I) American Spirit AR-15 pistol.
    - (II) Bushmaster Carbon 15 pistol.
    - (III) Chiappa Firearms M4 Pistol GEN II.
    - (IV) CORE Rifle Systems CORE15 Roscoe pistol.
    - (V) Daniel Defense MK18 pistol.
    - (VI) DoubleStar Corporation AR pistol.
    - (VII) DPMS AR-15 pistol.
    - (VIII) Jesse James Nomad AR-15 pistol.
    - (IX) Olympic Arms AR-15 pistol.
    - (X) Osprey Armament MK-18 pistol.
    - (XI) POF USA AR pistols.
    - (XII) Rock River Arms LAR 15 pistol.
    - (XIII) Uselton Arms Air-Lite M-4 pistol.
  - (iii) Calico pistols.
  - (iv) DSA SA58 PKP FAL pistol.
  - (v) Encom MP-9 and MP-45.
  - (vi) Heckler & Koch model SP-89 pistol.
  - (vii) Intratec AB-10, TEC-22 Scorpion, TEC-9, and TEC-DC9.
  - (viii) IWI Galil Ace pistol, UZI PRO pistol.
  - (ix) Kel-Tec PLR 16 pistol.
  - (x) All MAC types, including the following:
    - (I) MAC-10.
    - (II) MAC-11.
    - (III) Masterpiece Arms MPA A930 Mini Pistol, MPA460 Pistol, MPA Tactical Pistol, and MPA Mini Tactical Pistol.
    - (IV) Military Armament Corp. Ingram M-11.
    - (V) Velocity Arms VMAC.
  - (xi) Sig Sauer P556 pistol.

9/27/23, 2:54 PM

Illinois General Assembly - Illinois Compiled Statutes

- (xii) Sites Spectre.
- (xiii) All Thompson types, including the following:
  - (I) Thompson TA510D.
  - (II) Thompson TA5.
- (xiv) All UZI types, including Micro-UZI.
- (L) All of the following shotguns, copies, duplicates, variants, or altered facsimiles with the capability of any such weapon thereof:
  - (i) DERYA Anakon MC-1980, Anakon SD12.
  - (ii) Doruk Lethal shotguns.
  - (iii) Franchi LAW-12 and SPAS 12.
  - (iv) All IZHMASH Saiga 12 types, including the following:
    - (I) IZHMASH Saiga 12.
    - (II) IZHMASH Saiga 12S.
    - (III) IZHMASH Saiga 12S EXP-01.
    - (IV) IZHMASH Saiga 12K.
    - (V) IZHMASH Saiga 12K-030.
    - (VI) IZHMASH Saiga 12K-040 Taktika.
  - (v) Streetsweeper.
  - (vi) Striker 12.
- (2) "Assault weapon" does not include:
  - (A) Any firearm that is an unserviceable firearm or has been made permanently inoperable.
  - (B) An antique firearm or a replica of an antique firearm.
  - (C) A firearm that is manually operated by bolt, pump, lever or slide action, unless the firearm is a shotgun with a revolving cylinder.
  - (D) Any air rifle as defined in Section 24.8-0.1 of this Code.
  - (E) Any handgun, as defined under the Firearm Concealed Carry Act, unless otherwise listed in this Section.
- (3) "Assault weapon attachment" means any device capable of being attached to a firearm that is specifically designed for making or converting a firearm into any of the firearms listed in paragraph (1) of this subsection (a).
- (4) "Antique firearm" has the meaning ascribed to it in 18 U.S.C. 921(a)(16).
- (5) ".50 caliber rifle" means a centerfire rifle capable of firing a .50 caliber cartridge. The term does not include any antique firearm, any shotgun including a shotgun that has a rifle barrel, or any muzzle-loader which uses black powder for hunting or historical reenactments.
- (6) ".50 caliber cartridge" means a cartridge in .50 BMG caliber, either by designation or actual measurement, that is capable of being fired from a centerfire rifle. The term ".50 caliber cartridge" does not include any memorabilia or display item that is filled with a permanent inert substance or that is otherwise permanently altered in a manner that prevents ready modification for use as live ammunition or shotgun ammunition with a caliber measurement that is equal to or greater than .50 caliber.
- (7) "Detachable magazine" means an ammunition feeding device that may be removed from a firearm without disassembly of the firearm action, including an ammunition feeding device that may be readily removed from a firearm with the use of a bullet, cartridge, accessory, or other tool, or any other object that functions as a tool, including a bullet or cartridge.
- (8) "Fixed magazine" means an ammunition feeding device that is permanently attached to a firearm, or contained in and not



9/27/23, 2:54 PM

## Illinois General Assembly - Illinois Compiled Statutes

removable from a firearm, or that is otherwise not a detachable magazine, but does not include an attached tubular device designed to accept, and capable of operating only with, .22 caliber rimfire ammunition.

(b) Except as provided in subsections (c), (d), and (e), on or after the effective date of this amendatory Act of the 102nd General Assembly, it is unlawful for any person within this State to knowingly manufacture, deliver, sell, import, or purchase or cause to be manufactured, delivered, sold, imported, or purchased by another, an assault weapon, assault weapon attachment, .50 caliber rifle, or .50 caliber cartridge.

(c) Except as otherwise provided in subsection (d), beginning January 1, 2024, it is unlawful for any person within this State to knowingly possess an assault weapon, assault weapon attachment, .50 caliber rifle, or .50 caliber cartridge.

(d) This Section does not apply to a person's possession of an assault weapon, assault weapon attachment, .50 caliber rifle, or .50 caliber cartridge device if the person lawfully possessed that assault weapon, assault weapon attachment, .50 caliber rifle, or .50 caliber cartridge prohibited by subsection (c) of this Section, if the person has provided in an endorsement affidavit, prior to January 1, 2024, under oath or affirmation and in the form and manner prescribed by the Illinois State Police, no later than October 1, 2023:

(1) the affiant's Firearm Owner's Identification Card number;

(2) an affirmation that the affiant: (i) possessed an assault weapon, assault weapon attachment, .50 caliber rifle, or .50 caliber cartridge before the effective date of this amendatory Act of the 102nd General Assembly; or (ii) inherited the assault weapon, assault weapon attachment, .50 caliber rifle, or .50 caliber cartridge from a person with an endorsement under this Section or from a person authorized under subdivisions (1) through (5) of subsection (e) to possess the assault weapon, assault weapon attachment, .50 caliber rifle, or .50 caliber cartridge; and

(3) the make, model, caliber, and serial number of the .50 caliber rifle or assault weapon or assault weapons listed in paragraphs (J), (K), and (L) of subdivision (1) of subsection (a) of this Section possessed by the affiant prior to the effective date of this amendatory Act of the 102nd General Assembly and any assault weapons identified and published by the Illinois State Police pursuant to this subdivision (3). No later than October 1, 2023, and every October 1 thereafter, the Illinois State Police shall, via rulemaking, identify, publish, and make available on its website, the list of assault weapons subject to an endorsement affidavit under this subsection (d). The list shall identify, but is not limited to, the copies, duplicates, variants, and altered facsimiles of the assault weapons identified in paragraphs (J), (K), and (L) of subdivision (1) of subsection (a) of this Section and shall be consistent with the definition of "assault weapon" identified in this Section. The Illinois State Police may adopt emergency rulemaking in accordance with Section 5-45 of the Illinois Administrative Procedure Act. The adoption of emergency rules authorized by Section 5-45 of the Illinois Administrative Procedure Act and this paragraph is deemed to be necessary for the public interest, safety, and welfare.

The affidavit form shall include the following statement printed in bold type: "Warning: Entering false information on this form is punishable as perjury under Section 32-2 of the Criminal Code of 2012. Entering false information on this form

9/27/23, 2:54 PM

## Illinois General Assembly - Illinois Compiled Statutes

is a violation of the Firearm Owners Identification Card Act."

In any administrative, civil, or criminal proceeding in this State, a completed endorsement affidavit submitted to the Illinois State Police by a person under this Section creates a rebuttable presumption that the person is entitled to possess and transport the assault weapon, assault weapon attachment, .50 caliber rifle, or .50 caliber cartridge.

Beginning 90 days after the effective date of this amendatory Act of the 102nd General Assembly, a person authorized under this Section to possess an assault weapon, assault weapon attachment, .50 caliber rifle, or .50 caliber cartridge shall possess such items only:

- (1) on private property owned or immediately controlled by the person;
- (2) on private property that is not open to the public with the express permission of the person who owns or immediately controls such property;
- (3) while on the premises of a licensed firearms dealer or gunsmith for the purpose of lawful repair;
- (4) while engaged in the legal use of the assault weapon, assault weapon attachment, .50 caliber rifle, or .50 caliber cartridge at a properly licensed firing range or sport shooting competition venue; or
- (5) while traveling to or from these locations, provided that the assault weapon, assault weapon attachment, or .50 caliber rifle is unloaded and the assault weapon, assault weapon attachment, .50 caliber rifle, or .50 caliber cartridge is enclosed in a case, firearm carrying box, shipping box, or other container.

Beginning on January 1, 2024, the person with the endorsement for an assault weapon, assault weapon attachment, .50 caliber rifle, or .50 caliber cartridge or a person authorized under subdivisions (1) through (5) of subsection (e) to possess an assault weapon, assault weapon attachment, .50 caliber rifle, or .50 caliber cartridge may transfer the assault weapon, assault weapon attachment, .50 caliber rifle, or .50 caliber cartridge only to an heir, an individual residing in another state maintaining it in another state, or a dealer licensed as a federal firearms dealer under Section 923 of the federal Gun Control Act of 1968. Within 10 days after transfer of the weapon except to an heir, the person shall notify the Illinois State Police of the name and address of the transferee and comply with the requirements of subsection (b) of Section 3 of the Firearm Owners Identification Card Act. The person to whom the weapon or ammunition is transferred shall, within 60 days of the transfer, complete an affidavit required under this Section. A person to whom the weapon is transferred may transfer it only as provided in this subsection.

Except as provided in subsection (e) and beginning on January 1, 2024, any person who moves into this State in possession of an assault weapon, assault weapon attachment, .50 caliber rifle, or .50 caliber cartridge shall, within 60 days, apply for a Firearm Owners Identification Card and complete an endorsement application as outlined in subsection (d).

Notwithstanding any other law, information contained in the endorsement affidavit shall be confidential, is exempt from disclosure under the Freedom of Information Act, and shall not be disclosed, except to law enforcement agencies acting in the performance of their duties.

(e) The provisions of this Section regarding the purchase or possession of assault weapons, assault weapon attachments, .50 caliber rifles, and .50 cartridges, as well as the provisions of this Section that prohibit causing those items to be purchased

9/27/23, 2:54 PM

Illinois General Assembly - Illinois Compiled Statutes

or possessed, do not apply to:

(1) Peace officers, as defined in Section 2-13 of this Code.

(2) Qualified law enforcement officers and qualified retired law enforcement officers as defined in the Law Enforcement Officers Safety Act of 2004 (18 U.S.C. 926B and 926C) and as recognized under Illinois law.

(3) Acquisition and possession by a federal, State, or local law enforcement agency for the purpose of equipping the agency's peace officers as defined in paragraph (1) or (2) of this subsection (e).

(4) Wardens, superintendents, and keepers of prisons, penitentiaries, jails, and other institutions for the detention of persons accused or convicted of an offense.

(5) Members of the Armed Services or Reserve Forces of the United States or the Illinois National Guard, while performing their official duties or while traveling to or from their places of duty.

(6) Any company that employs armed security officers in this State at a nuclear energy, storage, weapons, or development site or facility regulated by the federal Nuclear Regulatory Commission and any person employed as an armed security force member at a nuclear energy, storage, weapons, or development site or facility regulated by the federal Nuclear Regulatory Commission who has completed the background screening and training mandated by the rules and regulations of the federal Nuclear Regulatory Commission and while performing official duties.

(7) Any private security contractor agency licensed under the Private Detective, Private Alarm, Private Security, Fingerprint Vendor, and Locksmith Act of 2004 that employs private security contractors and any private security contractor who is licensed and has been issued a firearm control card under the Private Detective, Private Alarm, Private Security, Fingerprint Vendor, and Locksmith Act of 2004 while performing official duties.

The provisions of this Section do not apply to the manufacture, delivery, sale, import, purchase, or possession of an assault weapon, assault weapon attachment, .50 caliber rifle, or .50 caliber cartridge or causing the manufacture, delivery, sale, importation, purchase, or possession of those items:

(A) for sale or transfer to persons authorized under subdivisions (1) through (7) of this subsection (e) to possess those items;

(B) for sale or transfer to the United States or any department or agency thereof; or

(C) for sale or transfer in another state or for export.

This Section does not apply to or affect any of the following:

(i) Possession of any firearm if that firearm is sanctioned by the International Olympic Committee and by USA Shooting, the national governing body for international shooting competition in the United States, but only when the firearm is in the actual possession of an Olympic target shooting competitor or target shooting coach for the purpose of storage, transporting to and from Olympic target shooting practice or events if the firearm is broken down in a nonfunctioning state, is not immediately accessible, or is unloaded and enclosed in a firearm case, carrying box, shipping box, or other similar portable container designed for the safe transportation of firearms, and when the Olympic target shooting competitor or target shooting coach is engaging in those practices or events. For the purposes

9/27/23, 2:54 PM

Illinois General Assembly - Illinois Compiled Statutes

of this paragraph (8), "firearm" has the meaning provided in Section 1.1 of the Firearm Owners Identification Card Act.

(ii) Any nonresident who transports, within 24 hours, a weapon for any lawful purpose from any place where the nonresident may lawfully possess and carry that weapon to any other place where the nonresident may lawfully possess and carry that weapon if, during the transportation, the weapon is unloaded, and neither the weapon nor any ammunition being transported is readily accessible or is directly accessible from the passenger compartment of the transporting vehicle. In the case of a vehicle without a compartment separate from the driver's compartment, the weapon or ammunition shall be contained in a locked container other than the glove compartment or console.

(iii) Possession of a weapon at an event taking place at the World Shooting and Recreational Complex at Sparta, only while engaged in the legal use of the weapon, or while traveling to or from that location if the weapon is broken down in a nonfunctioning state, is not immediately accessible, or is unloaded and enclosed in a firearm case, carrying box, shipping box, or other similar portable container designed for the safe transportation of firearms.

(iv) Possession of a weapon only for hunting use expressly permitted under the Wildlife Code, or while traveling to or from a location authorized for this hunting use under the Wildlife Code if the weapon is broken down in a nonfunctioning state, is not immediately accessible, or is unloaded and enclosed in a firearm case, carrying box, shipping box, or other similar portable container designed for the safe transportation of firearms. By October 1, 2023, the Illinois State Police, in consultation with the Department of Natural Resources, shall adopt rules concerning the list of applicable weapons approved under this subparagraph (iv). The Illinois State Police may adopt emergency rules in accordance with Section 5-45 of the Illinois Administrative Procedure Act. The adoption of emergency rules authorized by Section 5-45 of the Illinois Administrative Procedure Act and this paragraph is deemed to be necessary for the public interest, safety, and welfare.

(v) The manufacture, transportation, possession, sale, or rental of blank-firing assault weapons and .50 caliber rifles, or the weapon's respective attachments, to persons authorized or permitted, or both authorized and permitted, to acquire and possess these weapons or attachments for the purpose of rental for use solely as props for a motion picture, television, or video production or entertainment event.

Any person not subject to this Section may submit an endorsement affidavit if the person chooses.

(f) Any sale or transfer with a background check initiated to the Illinois State Police on or before the effective date of this amendatory Act of the 102nd General Assembly is allowed to be completed after the effective date of this amendatory Act once an approval is issued by the Illinois State Police and any applicable waiting period under Section 24-3 has expired.

(g) The Illinois State Police shall take all steps necessary to carry out the requirements of this Section within by October 1, 2023.

(h) The Department of the State Police shall also develop and implement a public notice and public outreach campaign to promote awareness about the provisions of this amendatory Act of the 102nd General Assembly and to increase compliance with this Section.

(Source: P.A. 102-1116, eff. 1-10-23.)



9/27/23, 2:54 PM

Illinois General Assembly - Illinois Compiled Statutes

---

[Home](#) | [Legislation & Laws](#) | [House](#) | [Senate](#) | [My Legislation](#) | [Disclaimers](#) | [Email](#)

---



This site is maintained for the Illinois General Assembly by the  
Legislative Information System, 705 Stratton Building, Springfield, Illinois 62706  
[Contact ILGA Webmaster](#)

# Exhibit B-10

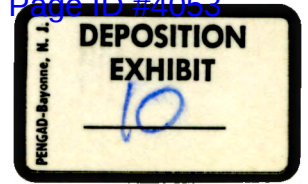

## State of Illinois

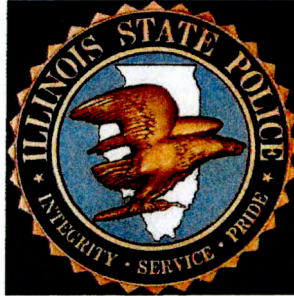

### Assault Weapon Identification Guide

As listed or described in Illinois Compiled Statutes 720 ILCS 5/24-1.9



**The purpose of this guide is to assist Law Enforcement Officers, Firearms Dealers, and the general public in the identification of assault weapons, as defined in the recently enacted Protect Illinois Communities Act. The Illinois State Police has prepared this guide in accordance with 720 ILCS 5/24-1.9(d)(3).**

Version 2023.10.01

## Table of Contents

Section (a) Definitions.....	Page 3
Section (a)(1)(A) Semiautomatic rifles (defined features).....	Page 3
Section (a)(1)(B) Semiautomatic rifles with fixed magazines.....	Page 7
Section (a)(1)(C) Semiautomatic pistols (defined features).....	Page 8
Section (a)(1)(D) Semiautomatic pistols with fixed magazines.....	Page 12
Section (a)(1)(E) Any shotgun with a revolving cylinder.....	Page 13
Section (a)(1)(F) Semiautomatic shotguns (defined features).....	Page 14
Section (a)(1)(G) Semiautomatic firearms with feed belts.....	Page 16
Section (a)(1)(H) Firearms modified to be assault weapons.....	Page 17
Section (a)(1)(I) Parts and combinations of parts.....	Page 18
Section (a)(1)(J)(i) AK-type rifles.....	Page 19
Other AK-type rifles, as defined in Section (a)(1)(A) .....	Page 25
Section (a)(1)(J)(ii) AR-type rifles.....	Page 27
Other AR-type rifles, as defined in Section (a)(1)(A) .....	Page 39
Other semiautomatic rifles as listed in Section (a)(1)(J).....	Page 43
Section (a)(1)(K)(i) AK-type pistols.....	Page 56
Other AK-type pistols, as defined in Section (a)(1)(C).....	Page 59
Section (a)(1)(K)(ii) AR-type pistols.....	Page 61
Other AR-type pistols, as defined in Section (a)(1)(C).....	Page 65
Other semiautomatic pistols as listed in Section (a)(1)(K).....	Page 68
Section (a)(1)(L) Shotguns.....	Page 79
Features Flowchart – Rifles.....	Page 83
Features Flowchart – Pistols.....	Page 84
Features Flowchart – Shotguns.....	Page 85



<b>(a) Definitions. In this Section:</b>		
<b>(1) "Assault weapon" means any of the following...</b>		
<b>(A) A semiautomatic rifle that has the capacity to accept a detachable magazine or that may be readily modified to accept a detachable magazine, if the firearm has one or more of the following:</b>		
<b>Red arrows point to the prohibited feature. Images depict representative examples of the prohibited feature; other configurations exist.</b>		
<b>(A)(i) a pistol grip or thumbhole stock;</b>		
<b>(A)(i)</b>	pistol grip	
<b>(A)(i)</b>	thumbhole stock	
<b>(A)(ii) any feature capable of functioning as a protruding grip that can be held by the non-trigger hand;</b>		
<b>(A)(ii)</b>	Protruding grip	

**(A)(iii) a folding, telescoping, thumbhole, or detachable stock, or a stock that is otherwise foldable or adjustable in a manner that operates to reduce the length, size, or any other dimension, or otherwise enhances the concealability of, the weapon;**

<p>(A)(iii)</p>	<p>Folding stock</p>	
<p>(A)(iii)</p>	<p>Telescoping stock</p>	

(A)(iii)	Thumbhole stock	 <p data-bbox="557 594 1414 661">Pictured: US M1 Carbine with folding "paratrooper" stock (folded in lower image)</p>
(A)(iii)	Detachable stock	
<b>(A)(iv) a flash suppressor;</b>		
(A)(iv)	Flash suppressor	
<b>(A)(v) a grenade launcher;</b>		
(A)(v)	Grenade launcher	



**(A)(vi) a shroud attached to the barrel or that partially or completely encircles the barrel, allowing the bearer to hold the firearm with the non-trigger hand without being burned, but excluding a slide that encloses the barrel.**

(A)(vi)	Shroud	
---------	--------	--



**(B) A semiautomatic rifle that has a fixed magazine with the capacity to accept more than 10 rounds, except for an attached tubular device designed to accept, and capable of operating only with, .22 caliber rimfire ammunition.**



**(C) A semiautomatic pistol that has the capacity to accept a detachable magazine or that may be readily modified to accept a detachable magazine, if the firearm has one or more of the following:**

**(C)(i) a threaded barrel;**



**(C)(ii) a second pistol grip or another feature capable of functioning as a protruding grip that can be held by the non-trigger hand;**



**(C)(iii) a shroud attached to the barrel or that partially or completely encircles the barrel, allowing the bearer to hold the firearm with the non-trigger hand without being burned, but excluding a slide that encloses the barrel;**

(C)(iii)

Shroud



**(C)(iv) a flash suppressor;**

(C)(iv)

Flash suppressor



<b>(C)(v) the capacity to accept a detachable magazine at some location outside of the pistol grip; or</b>		
(C)(v)	Capacity to accept a detachable magazine at some location outside of the pistol grip	
<b>(C)(vi) a buffer tube, arm brace, or other part that protrudes horizontally behind the pistol grip and is designed or redesigned to allow or facilitate a firearm to be fired from the shoulder.</b>		
(C)(vi)	Buffer tube	
(C)(vi)	Arm brace	



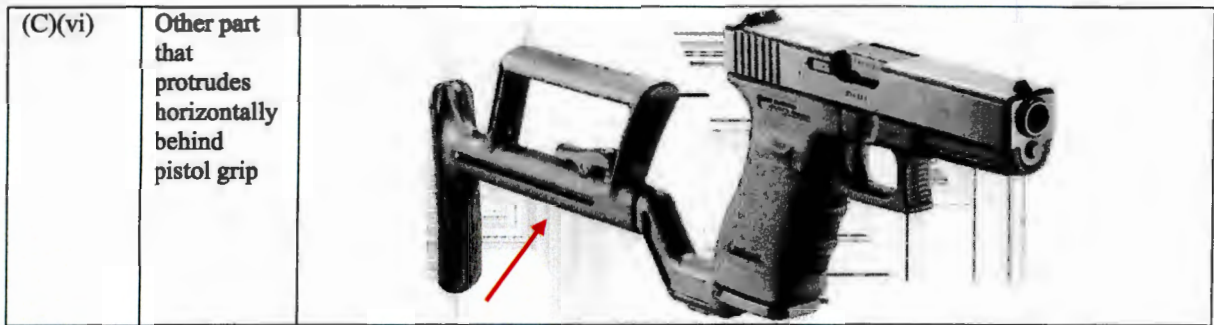



**(D) A semiautomatic pistol that has a fixed magazine with the capacity to accept more than 15 rounds.**



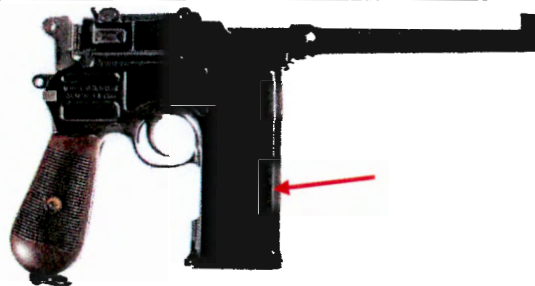

(D)

Fixed magazine with capacity to accept more than 15 rounds



Pictured: Mauser, C96 "Broomhandle" (w/ fixed 20 round magazine)

<b>(E) Any shotgun with a revolving cylinder.</b>		
(E)	A revolving cylinder	 <p>Pictured: SRM Arms SRM 1216</p>

<b>(F) A semiautomatic shotgun that has one or more of the following:</b>		
<b>(F)(i) a pistol grip or thumbhole stock;</b>		
(F)(i)	Thumbhole stock	
<b>(F)(ii) any feature capable of functioning as a protruding grip that can be held by the non-trigger hand;</b>		
(F)(ii)	Feature capable of functioning as protruding grip	
<b>(F)(iii) a folding or thumbhole stock;</b>		
(F)(iii)	Folding stock	
(F)(iii)	Thumbhole stock	



<b>(F)(iv) a grenade launcher;</b>		
(F)(iv)	Grenade launcher	 <p>Pictured: Saiga 12 gauge semiautomatic shotgun with 37 mm flare launcher attached under the barrel. Grenade launcher will look similar.</p>
<b>(F)(v) a fixed magazine with the capacity of more than 5 rounds; or</b>		
(F)(v)	Fixed magazine with capacity of more than 5 rounds	 <p>Pictured: Tavor TS12 – three fixed magazine tubes, each holding up to five 2 3/4" 12 gauge shells</p>
<b>(F)(vi) the capacity to accept a detachable magazine.</b>		
(F)(vi)	Capacity to accept a detachable magazine	



**(G) Any semiautomatic firearm that has the capacity to accept a belt ammunition feeding device.**

(G)

Any semiautomatic firearm that has capacity to accept a belt ammunition feeding device



Pictured: Belt-fed, semiautomatic, RPD rifle

<b>(H) Any firearm that has been modified to be operable as an assault weapon as defined in this Section.</b>		
(H)	Any firearm that has been modified to be operable as an assault weapon [as defined by 720 ILCS 5/24-1.9 (a)(1)]	 <p>Unmodified Ruger, model 10/22 (not restricted)</p>  <p>Ruger, model 10/22, with aftermarket collapsible stock, pistol grip, and large capacity magazine (restricted)</p>

**(I) Any part or combination of parts designed or intended to convert a firearm into an assault weapon, including any combination of parts from which an assault weapon may be readily assembled if those parts are in the possession or under the control of the same person.**

(I)

Combination of parts designed or intended to convert a firearm into an assault weapon.



Semiautomatic SKS Rifle with fixed, ten-round capacity magazine (not restricted on its own)





Combination of parts: Semiautomatic SKS rifle, plus pistol grip collapsible stock, plus detachable magazine, plus flash suppressor (combination of parts is restricted)



Semiautomatic SKS with above listed parts installed (restricted)



<b>Statutory List of Restricted AK Types</b>		
<b>(J) All of the following rifles, copies, duplicates, variants, or altered facsimiles with the capability of any such weapon:</b>		
<b>(i) All AK types, including the following:</b>		
<b>(J)(i)(I) AK, AK47, AK47S, AK-74, AKM, AKS, ARM, MAK90, MISR, NHM90, NHM91, SA85, SA93, Vector Arms AK-47, VEPR, WASR-10, and WUM.</b>		
In each instance, a representative image is provided; however, these firearms may be found in various configurations.		
(J)(i)(I)	AK	 <p>“AK” is a general term for a class of rifles based on the original Kalashnikov-designed AK-47, an example of which is pictured here.</p>
(J)(i)(I)	AK47	
(J)(i)(I)	AK47S	 <p>“S” variants of the AK series of rifle have a downward folding stock. Pictured is an AKS-47 rifle.</p>

(J)(i)(I)	AK-74	 A photograph of an AK-74 assault rifle, featuring a black receiver and a distinctive curved, olive-drab magazine. The rifle is shown from a side profile against a dark, textured background.
(J)(i)(I)	AKM	 A photograph of an AKM assault rifle with a black metal receiver and a curved black magazine. It has a wooden stock and handguard. The rifle is shown from a side profile against a plain white background.
(J)(i)(I)	AKS	 A photograph of an AKS assault rifle, which is a subcompact variant. It has a black receiver, a curved black magazine, and a folding front sight. A tan shoulder strap is attached to the rifle. The rifle is shown from a side profile against a plain white background.
(J)(i)(I)	(Maadi) ARM	 A photograph of a (Maadi) ARM assault rifle, featuring a black receiver and a curved black magazine. It has a wooden stock and handguard. The rifle is shown from a side profile against a plain white background.
(J)(i)(I)	MAK90	 A photograph of a MAK90 assault rifle, which is a compact variant. It has a black receiver and a curved black magazine. The stock and handguard are made of wood. The rifle is shown from a side profile against a plain white background.



(J)(i)(I)	(Maadi) MISR	
(J)(i)(I)	NHM90 (with thumbhole stock)	
(J)(i)(I)	Norinco NHM91	
(J)(i)(I)	FEG SA85	
(J)(i)(I)	Arsenal (Bulgaria) SA93	
(J)(i)(I)	Vector Arms AK- 47 (AKS)	



(J)(i)(I)	VEPR (FM- AK47-11)	
(J)(i)(I)	WASR-10 with flash suppressor	
(J)(i)(I)	WUM (Romanian WUM1)	
<b>(J)(i)(II) IZHMAH Saiga AK.</b>		
(J)(i)(II)	IZHMASH Saiga AK	
<b>(J)(i)(III) MAADI AK47 and ARM.</b>		
(J)(i)(III)	Maadi AK- 47 with side folding stock	



(J)(i)(III)	Maadi ARM	 A black and orange Maadi ARM rifle, featuring a curved magazine and a wooden stock.
<b>(J)(i)(IV) Norinco 56S, 56S2, 84S, and 86S.</b>		
(J)(i)(IV)	Norinco 56S	 A black and orange Norinco 56S rifle, featuring a curved magazine and a wooden stock.
(J)(i)(IV)	Norinco 56S2	 A black and orange Norinco 56S2 rifle, featuring a curved magazine and a wooden stock.
(J)(i)(IV)	Norinco 84S	 A black and orange Norinco 84S rifle, featuring a curved magazine and a wooden stock.
(J)(i)(IV)	Norinco 86S	 A black Norinco 86S rifle, featuring a curved magazine and a metal stock.

<b>(J)(i)(V) Poly Technologies AK47 and AKS.</b>		
(J)(i)(V)	Poly Technologies AK 47	
(J)(i)(V)	Poly Technologies AKS	
<b>(J)(i)(VI) SKS with a detachable magazine.</b>		
(J)(i)(VI)	SKS with detachable magazine	

<b>Other "AK-Type" Rifles as defined by the Protecting Illinois Communities Act</b>	
Palmetto State Armory (PSA) PSAK-47 GF3	
Century Arms VSKA	
Kalashnikov USA KR-103	
Riley Defense RAK-47-C	
Zastava M70 ZPAP	
Bulgarian Arsenal SLR-107	



<p>Hungarian FEG (SA-85M)</p>	 A side-view photograph of a Hungarian FEG (SA-85M) assault rifle. The rifle is primarily black with a distinctive orange-colored handguard and a matching orange pistol grip. It features a curved magazine and a telescopic sight mounted on the front.
<p>FB Radom Beryl M762</p>	 A side-view photograph of an FB Radom Beryl M762 assault rifle. The rifle is entirely black and has a more modern, modular design with a Picatinny rail system on top. It includes a curved magazine and a telescopic sight.
<p>WBP Mini Jack</p>	 A side-view photograph of a WBP Mini Jack assault rifle. The rifle is black with a prominent red-colored handguard and a matching red pistol grip. It has a curved magazine and a telescopic sight.



<b>Statutory List of AR Types</b>		
<b>(J)(ii) all AR types, including the following:</b>		
<b>In each instance, a representative image is provided; however, these firearms may be found in various configurations.</b>		
<b>(J)(ii)(I) AR-10.</b>		
<b>(J)(ii)(I)</b>	DPMS LR-243 AR-10	
<b>(J)(ii)(II) AR-15.</b>		
<b>(J)(ii)(II)</b>	Colt LE6920 Series AR-15, 16" barrel, with collapsible stock, vertical fore grip, and flash suppressor	
<b>(J)(ii)(III) Alexander Arms Overmatch Plus 16.</b>		
<b>(J)(ii)(III)</b>	Alexander Arms Overmatch Plus 16	

<b>(J)(ii)(IV) Armalite M-15 22LR Carbine.</b>		
(J)(ii)(IV)	Armalite M-15 22LR Carbine	
<b>(J)(ii)(V) Armalite M15-T.</b>		
(J)(ii)(V)	Armalite M15-T	
<b>(J)(ii)(VI) Barrett REC7.</b>		
(J)(ii)(VI)	Barrett REC7	
<b>(J)(ii)(VII) Beretta AR-70.</b>		
(J)(ii) (VII)	Beretta AR70 with flash suppressor	

<b>(J)(ii)(VIII) Black Rain Ordnance Recon Scout.</b>		
(J)(ii)(VIII)	Black Rain Ordnance Recon Scout	
<b>(J)(ii)(IX) Bushmaster ACR.</b>		
(J)(ii)(IX)	Bushmaster ACR	
<b>(J)(ii)(X) Bushmaster Carbon 15.</b>		
(J)(ii)(X)	Bushmaster Carbon 15	
<b>(J)(ii)(XI) Bushmaster MOE series.</b>		
(J)(ii)(XI)	Bushmaster MOE series	



<b>(J)(ii)(XII) Bushmaster XM15.</b>		
(J)(ii) (XII)	Bushmaster XM15-E2S, 16" barrel, with collapsible stock and flash suppressor	
<b>(J)(ii)(XIII) Chiappa Firearms MFour rifles.</b>		
(J)(ii) (XIII)	Chiappa Firearms MFour rifles	
<b>(J)(ii)(XIV) Colt Match Target rifles.</b>		
(J)(ii)(XIV)	Colt Match Target rifles	
<b>(J)(ii)(XV) CORE Rifle Systems CORE15 rifles.</b>		
(J)(ii)(XV)	CORE Rifle Systems CORE15 rifles	



<b>(J)(ii)(XVI) Daniel Defense M4A1 rifles.</b>		
(J)(ii)(XVI)	Daniel Defense M4A1 with collapsible stock and flash suppressor	
<b>(J)(ii)(XVII) Devil Dog Arms 15 Series rifles.</b>		
(J)(ii)(XVII)	Devil Dog Arms 15 series rifle	
<b>(J)(ii)(XVIII) Diamondback DB15 rifles.</b>		
(J)(ii)(XVIII)	Diamondback DB15 rifles	
<b>(J)(ii)(XIX) DoubleStar AR rifles.</b>		
(J)(ii)(XIX)	DoubleStar AR rifles	

<b>(J)(ii)(XX) DPMS Tactical rifles.</b>		
(J)(ii)(XX)	DPMS Tactical Rifles	
<b>(J)(ii)(XXI) DSA Inc. ZM-4 Carbine.</b>		
(J)(ii)(XXI)	DSA Inc. ZM-4 Carbine	
<b>(J)(ii)(XXII) Heckler &amp; Koch MR556.</b>		
(J)(ii)(XXII )	Heckler & Koch MR556	
<b>(J)(ii)(XXIII) High Standard HSA-15 rifles.</b>		
(J)(ii)(XXIII I)	High Standard HSA-15 rifles	

<b>(J)(ii)(XXIV) Jesse James Nomad AR-15 rifle.</b>		
(J)(ii)(XXI V)	Jesse James Nomad AR-15 rifle	
<b>(J)(ii)(XXV) Knight's Armament SR-15.</b>		
(J)(ii)(XX V)	Knight's Armament SR-15	
<b>(J)(ii)(XXVI) Lancer L15 rifles.</b>		
(J)(ii)(XX VI)	Lancer L15 rifles	
<b>(J)(ii)(XXVII) MGI Hydra Series rifles.</b>		
(J)(ii)(XX VII)	MGI Hydra Series rifle	



<b>(J)(ii)(XXVIII) Mossberg MMR Tactical rifles.</b>		
(J)(ii)(XXVIII)	Mossberg MMR Tactical rifles	
<b>(J)(ii)(XXIX) Noreen Firearms BN 36 rifle.</b>		
(J)(ii)(XXIX)	Noreen Firearms BN 36 rifle	
<b>(J)(ii)(XXX) Olympic Arms.</b>		
(J)(ii)(XXX)	Olympic Arms AR-15 with collapsible stock and flash suppressor	
<b>(J)(ii)(XXXI) POF USA P415.</b>		
(J)(ii)(XXXI)	POF USA P415	
<b>(J)(ii)(XXXII) Precision Firearms AR rifles.</b>		
(J)(ii)(XXXII)	Precision Firearms AR rifles	



<b>(J)(ii)(XXXIII) Remington R-15 rifles.</b>		
(J)(ii)(XX XIII)	Remington R-15 rifles	
<b>(J)(ii)(XXXIV) Rhino Arms AR rifles.</b>		
(J)(ii)(XX XIV)	Rhino Arms AR rifles	
<b>(J)(ii)(XXXV) Rock River Arms LAR-15 or Rock River Arms LAR-47.</b>		
(J)(ii)(XX XV)	Rock River Arms LAR-15 with collapsible stock and flash suppressor	
(J)(ii)(XX XV)	Rock River Arms LAR-47	

<b>(J)(ii)(XXXVI) Sig Sauer SIG516 rifles and MCX rifles.</b>		
(J)(ii)(XX XVI)	Sig Sauer SIG516 rifles	
(J)(ii)(XX XVI)	Sig Sauer MCX rifles	
<b>(J)(ii)(XXXVII) Smith &amp; Wesson M&amp;P15 rifles.</b>		
(J)(ii)(XX XVII)	Smith & Wesson M&P Sport 2 AR15 with collapsible stock, vertical foregrip, and flash suppressor	
<b>(J)(ii)(XXXVIII) Stag Arms AR rifles.</b>		
(J)(ii)(XX XVIII)	Stag Arms rifles	

<b>(J)(ii)(XXXIX) Sturm, Ruger &amp; Co. SR556 and AR-556 rifles.</b>		
(J)(ii)(XX XIX)	Sturm, Ruger & Co. SR556 rifles	
(J)(ii)(XX XIX)	Sturm, Ruger & Co. SR556 rifles	
<b>(J)(ii)(XL) Uselton Arms Air-Lite M-4 rifles.</b>		
(J)(ii)(XL)	Uselton Arms Air-Lite M-4 rifles	
<b>(J)(ii)(XLI) Windham Weaponry AR rifles.</b>		
(J)(ii)(XLI)	Windham Weaponry AR rifles	
<b>(J)(ii)(XLII) WMD Guns Big Beast.</b>		
(J)(ii)(XLII )	WMD Guns Big Beast	



<b>(J)(ii)(XLIII) Yankee Hill Machine Company, Inc. YHM-15 rifles.</b>		
(J)(ii)(XLIII) I)	Yankee Hill Machine Company, Inc. YHM-15 rifles	 A black silhouette of a YHM-15 rifle, shown in profile facing right. The rifle features a short barrel, a compact receiver, a magazine, and a stock. The silhouette is solid black against a white background.



<b>Other "AR-Type" Rifles as defined by the Protecting Illinois Communities Act</b>	
Anderson AM-15 BR	 A black AR-style rifle with a long barrel, a handguard, and a magazine.
Ruger AR-556 MPR with M-LOK rail	 A black AR-style rifle with a handguard featuring M-LOK slots and a magazine.
Springfield Armory Saint Victor	 A black AR-style rifle with a tan-colored handguard and a magazine.
Radical Firearms RF-15 SOCOM	 A black AR-style rifle with a handguard featuring M-LOK slots and a magazine.

<p>Ruger AR-556 MPR</p>	 A black Ruger AR-556 MPR rifle with a long barrel and a flat-top receiver.
<p>Ruger AR-556 NATO M4 Flat-Top</p>	 A black Ruger AR-556 NATO M4 Flat-Top rifle with a shorter barrel and a flat-top receiver.
<p>Springfield Saint 5.56 NATO</p>	 A black Springfield Saint 5.56 NATO rifle with a long barrel and a flat-top receiver.
<p>American Tactical OMNI Hybrid Maxx</p>	 A black American Tactical OMNI Hybrid Maxx rifle with a long barrel and a flat-top receiver.
<p>Daniel Defense DDM4 V7</p>	 A black Daniel Defense DDM4 V7 rifle with a long barrel and a flat-top receiver.

<p>Palmetto State Armory (PSA) PA-15</p>	 A black semi-automatic rifle with a standard AR-15 style design, featuring a handguard with Picatinny rails, a black magazine, and a black stock.
<p>Aero Precision AC-15</p>	 A black semi-automatic rifle with a handguard that has a textured, knurled appearance, a black magazine, and a black stock.
<p>Bravo Company MID-16 Mod O</p>	 A black semi-automatic rifle with a handguard that has a textured, knurled appearance, a black magazine, and a black stock.
<p>FN America FN 15 Patrol Rifle</p>	 A black semi-automatic rifle with a handguard that has a textured, knurled appearance, a black magazine, and a black stock.
<p>Geiselle Automatics Super Duty series</p>	 A black semi-automatic rifle with a handguard that has a textured, knurled appearance, a black magazine, and a black stock.
<p>Lead Star Arms Grunt Rifle</p>	 A black semi-automatic rifle with a handguard that has a textured, knurled appearance, a black magazine, and a black stock.

<p>LMT Defense SPM16</p>	 A black LMT Defense SPM16 rifle, shown from a side profile. It features a compact design with a short barrel, a handguard, and a magazine.
<p>LWRC International IC-SPR</p>	 A LWRC International IC-SPR rifle, shown from a side profile. It has a tan-colored upper receiver and handguard, and a black lower receiver and magazine.
<p>ZRO Delta Ready Series</p>	 A ZRO Delta Ready Series rifle, shown from a side profile. It is a black, compact rifle with a handguard and a magazine.



<b>(J)(iii) Barrett M107A1.</b>		
(J)(iii)	Barrett M107A1, 50 BMG caliber	
<b>(J)(iv) Barrett M82A1.</b>		
(J)(iv)	Barrett M82A1, 50 BMG caliber	
<b>(J)(v) Beretta CX4 Storm.</b>		
(J)(v)	Beretta CX4 Storm	
<b>(J)(vi) Calico Liberty Series.</b>		
(J)(vi)	Calico Liberty Series 50 Carbine with 50 round magazine	
<b>(J)(vii) CETME Sporter.</b>		
(J)(vii)	Century Arms CETME Sporter	

<b>(J)(viii) Daewoo K-1, K-2, Max 1, Max 2, AR 100, and AR 110C.</b>		
(J)(viii)	Daewoo K-1	
(J)(viii)	Daewoo K-2	
(J)(viii)	Daewoo Max 1	
(J)(viii)	Daewoo Max 2	
(J)(viii)	Daewoo AR 100	
(J)(viii)	Daewoo AR 110C	

<b>(J)(ix) Fabrique Nationale/FN Herstal FAL, LAR, 22 FNC, 308 Match, L1A1 Sporter, PS90, SCAR, and FS2000.</b>		
(J)(ix)	Fabrique Nationale FAL	
(J)(ix)	Fabrique Nationale LAR	
(J)(ix)	Fabrique Nationale 22 FNC	
(J)(ix)	Fabrique Nationale 308 Match	
(J)(ix)	Century Arms Fabrique Nationale FAL L1A1 Sporter	
(J)(ix)	Fabrique Nationale PS90	



(J)(ix)	FN SCAR	
(J)(ix)	Fabrique Nationale FS2000	
<b>(J)(x) Feather Industries AT-9.</b>		
(J)(x)	Feather Industries AT-9	
<b>(J)(xi) Galil Model AR and Model ARM.</b>		
(J)(xi)	Galil Model AR	
(J)(xi)	Galil Model ARM	







<b>(J)(xii) Hi-Point Carbine.</b>		
(J)(xii)	Hi-Point Carbine with vertical foregrip	
<b>(J)(xiii) HK-91, HK-93, HK-94, HK-PSG-1, and HK USC.</b>		
(J)(xiii)	Heckler & Koch HK91	
(J)(xiii)	Heckler & Koch HK93	
(J)(xiii)	Heckler & Koch HK94	
(J)(xiii)	Heckler & Koch-PSG-1	

(J)(xiii)	Heckler & Koch USC	
<b>(J)(xiv) IWI TAVOR, Galil ACE rifle.</b>		
(J)(xiv)	IWI TAVOR, Galil ACE rifle	
<b>(J)(xv) Kel-Tec Sub-2000, SU-16, and RFB.</b>		
(J)(xv)	Kel-Tec Sub-2000 (shown fully extended and folded for storage)	
(J)(xv)	Kel-Tec SU-16 (shown with bipod fully extended and folded for storage)	





(J)(xv)	Kel-Tec RFB	
<b>(J)(xvi) SIG AMT, SIG PE-57, Sig Sauer SG 550, Sig Sauer SG 551, and SIG MCX.</b>		
(J)(xvi)	SIG AMT	
(J)(xvi)	SIG PE-57	
(J)(xvi)	SIG SG 550	
(J)(xvi)	SIG SG 551	
(J)(xvi)	SIG MCX	



<b>(J)(xvii) Springfield Armory SAR-48.</b>		
(J)(xvii)	Springfield Armory SAR-48	
<b>(J)(xviii) Steyr AUG.</b>		
(J)(xviii)	Steyr AUG	
<b>(J)(xix) Sturm, Ruger &amp; Co. Mini-14 Tactical Rifle M-14/20CF.</b>		
(J)(xix)	Sturm, Ruger & Co. Mini-14 Tactical/20 CF	
<b>(J)(xx) All Thompson rifles, including the following:</b>		
<b>(J)(xx)(I) Thompson M1SB.</b>		
(J)(xx)(I)	Thompson M1SB	
<b>(J)(xx)(II) Thompson T1100D.</b>		
(J)(xx)(II)	Thompson T1100D	



<b>(J)(xx)(III) Thompson T150D.</b>		
(J)(xx) (III)	Thompson T150D	
<b>(J)(xx)(IV) Thompson T1B.</b>		
(J)(xx) (IV)	Thompson T1B	
<b>(J)(xx)(V) Thompson T1B100D.</b>		
(J)(xx) (V)	Thompson T1B100D	
<b>(J)(xx)(VI) Thompson T1B50D.</b>		
(J)(xx) (VI)	Thompson T1B50D	
<b>(J)(xx)(VII) Thompson T1BSB.</b>		
(J)(xx) (VII)	Thompson T1BSB	

<b>(J)(xx)(VIII) Thompson T1-C.</b>		
(J)(xx) (VIII)	Thompson T1-C	
<b>(J)(xx)(IX) Thompson T1D.</b>		
(J)(xx) (IX)	Thompson T1D	
<b>(J)(xx)(X) Thompson T1SB.</b>		
(J)(xx)(X)	Thompson T1SB	
<b>(J)(xx)(XI) Thompson T5.</b>		
(J)(xx) (XI)	Thompson T5	
<b>(J)(xx)(XII) Thompson T5100D.</b>		
(J)(xx) (XII)	Thompson T5100D	

<b>(J)(xx)(XIII) Thompson TM1.</b>		
(J)(xx) (XIII)	Thompson TM1	
<b>(J)(xx)(XIV) Thompson TM1C.</b>		
(J)(xx) (XIV)	Thompson TM1C	
<b>(J)(xxi) UMAREX UZI rifle.</b>		
(J)(xxi)	UMAREX UZI Rifle	
<b>(J)(xxii) UZI Mini Carbine, UZI Model A Carbine, and UZI Model B Carbine.</b>		
(J)(xxii)	UZI Mini Carbine	



(J)(xxii)	UZI Model A Carbine	
(J)(xxii)	UZI Model B Carbine	
<b>(J)(xxiii) Valmet M62S, M71S, and M78.</b>		
(J)(xxiii)	Valmet M62S	
(J)(xxiii)	Valmet M71S	
(J)(xxiii)	Valmet M78	



<b>(J)(xxiv) Vector Arms UZI Type.</b>		
(J)(xxiv)	Vector Arms UZI type	
<b>(J)(xxv) Weaver Arms Nighthawk.</b>		
(J)(xxv)	Weaver Arms Nighthawk	
<b>(J)(xxvi) Wilkinson Arms Linda Carbine.</b>		
(J)(xxvi)	Wilkinson Arms Linda Carbine	

<p><b>(K) All of the following pistols, copies, duplicates, variants, or altered facsimiles with the capability of any such weapon thereof:</b></p>		
<p><b>(K)(i) All AK types, including the following:</b></p>		
<p><b>(K)(i)(I) Centurion 39 AK pistol.</b></p>		
<p>(K)(i)(I)</p>	<p>Centurion 39 AK pistol</p>	
<p><b>(K)(i)(II) CZ Scorpion pistol.</b></p>		
<p>(K)(i)(II)</p>	<p>CZ Scorpion pistol</p>	
<p><b>(K)(i)(III) Draco AK-47 pistol.</b></p>		
<p>(K)(i)(III)</p>	<p>Draco AK-47 pistol</p>	

<b>(K)(i)(IV) HCR AK-47 pistol.</b>		
(K)(i)(IV)	HCR AK-47 pistol	No Image Available
<b>(K)(i)(V) IO Inc. Hellpup AK-47 pistol.</b>		
(K)(i)(V)	IO Inc. Hellpup AK-47 pistol	
<b>(K)(i)(VI) Krinkov pistol.</b>		
(K)(i)(VI)	(Arsenal SLR106) Krinkov pistol	
<b>(K)(i)(VII) Mini Draco AK-47 pistol.</b>		
(K)(i)(VII)	Mini Draco AK-47 pistol	





<b>(K)(i)(VIII) PAP M92 pistol.</b>		
<b>(K)(i) (VIII)</b>	<b>(Zastava) PAP M92 pistol</b>	
<b>(K)(i)(IX) Yugo Krebs Krink pistol.</b>		
<b>(K)(i)(IX)</b>	<b>Krebs Custom Krink pistol</b>	



<b>Other "AK-Type" Pistols as defined by the Protecting Illinois Communities Act</b>	
Palmetto State Armory (PSA) AK-P MOE	 A black, semi-automatic assault rifle with a curved magazine and a long barrel.
Zastava PAP M85	 A black semi-automatic assault rifle with a curved magazine and a distinctive orange-colored handguard.
Century Arms RAS	 A black semi-automatic assault rifle with a curved magazine and a long barrel.
Arsenal SAM7K-44	 A black semi-automatic assault rifle with a curved magazine and a long barrel.

<p>Charles Daly PAK-9</p>	 A black Charles Daly PAK-9 submachine gun shown from a side profile. It features a compact design with a folding stock, a magazine, and a front sight.
<p>Kalashnikov USA KP-9</p>	 A silver-colored Kalashnikov USA KP-9 submachine gun shown from a side profile. It has a more traditional submachine gun design with a magazine, a folding stock, and a front sight.



<b>(K)(ii) All AR types, including the following:</b>		
<b>(K)(ii)(I) American Spirit AR-15 pistol.</b>		
(K)(ii)(I)	American Spirit AR-15 pistol	
<b>(K)(ii)(II) Bushmaster Carbon 15 pistol.</b>		
(K)(ii)(II)	Bushmaster Carbon 15 pistol with padded buffer tube	
<b>(K)(ii)(III) Chiappa Firearms M4 Pistol GEN II.</b>		
(K)(ii)(III)	Chiappa Firearms M4 Gen II pistol	

<b>(K)(ii)(IV) CORE Rifle Systems CORE15 Roscoe pistol.</b>		
(K)(ii)(IV)	CORE Rifle Systems CORE15 Roscoe pistol	 <p>(10.5" barrel) with pistol brace</p>
<b>(K)(ii)(V) Daniel Defense MK18 pistol.</b>		
(K)(ii)(V)	Daniel Defense Mk18 pistol	 <p>(10.3" barrel) with pistol brace</p>
<b>(K)(ii)(VI) DoubleStar Corporation AR pistol.</b>		
(K)(ii)(VI)	DoubleStar Corporation	 <p>ARP7 pistol with pistol brace</p>
<b>(K)(ii)(VII) DPMS AR-15 pistol.</b>		
(K)(ii)(VII)	DPMS AR-15 pistol	



<b>(K)(ii)(VIII) Jesse James Nomad AR-15 pistol.</b>		
(K)(ii)(VIII)	Jesse James Nomad AR-15 pistol	
<b>(K)(ii)(IX) Olympic Arms AR-15 pistol.</b>		
(K)(ii)(IX)	Olympic Arms (OA-93) AR-15 pistol	
<b>(K)(ii)(X) Osprey Armament MK-18 pistol.</b>		
(K)(ii)(X)	Osprey Armament Mk-18 pistol	 <p data-bbox="532 1593 1149 1629">Pictured: Daniel Defense, Mk-18, AR-style pistol</p>

<b>(K)(ii)(XI) POF USA AR pistols.</b>		
(K)(ii)(XI)	POF USA AR pistols	
<b>(K)(ii)(XII) Rock River Arms LAR 15 pistol.</b>		
(K)(ii)(XII)	Rock River Arms LAR 15 pistol with pistol brace	
<b>(K)(ii)(XIII) Uselton Arms Air-Lite M-4 pistol.</b>		
(K)(ii)(XIII)	Uselton Arms Air- Lite M-4 pistol	

<b>Other "AR-Type" Pistols as defined by the Protecting Illinois Communities Act</b>	
Palmetto State Armory (PSA) Marauder MOE	
Bravo Company (BCM) Recce-11	
Sig Sauer PMCX Spear-LT	
Battle Arms Development Workhorse	



<p>F-1 Firearms FDR-15</p>	 A black, compact assault rifle with a short barrel and a folding stock, shown from a side profile.
<p>LMT Defense MARS-L</p>	 A black assault rifle with a standard-length barrel and a fixed stock, shown from a side profile.
<p>CORE Rifle Systems 300 BLK Truck Gun</p>	 A black assault rifle with a long barrel and a fixed stock, shown from a side profile.
<p>Diamondback DB15 Pistol</p>	 A black assault rifle with a long barrel and a fixed stock, shown from a side profile.
<p>Radical Firearms FP7 series</p>	 A black assault rifle with a long barrel and a fixed stock, shown from a side profile.





<b>(K)(iii) Calico pistols.</b>		
(K)(iii)	Calico M950	
<b>(K)(iv) DSA SA58 PKP FAL pistol.</b>		
(K)(iv)	DSA SA58 PKP FAL	
<b>(K)(v) Encom MP-9 and MP-45.</b>		
(K)(v)	Encom MP-9	





**(K)(vi) Heckler & Koch model SP-89 pistol.**



**(K)(vii) Intratec AB-10, TEC-22 Scorpion, TEC-9, and TEC-DC9.**



<p>(K)(vii)</p>	<p>Intratec Tec-22</p>	 A black silhouette of an Intratec Tec-22 subcompact handgun, shown from a side profile. It features a short barrel, a curved magazine, and a textured grip.
<p>(K)(vii)</p>	<p>Intratec Scorpion</p>	 A black silhouette of an Intratec Scorpion subcompact handgun, shown from a side profile. It has a similar design to the Tec-22 but with a slightly different magazine shape and grip texture.
<p>(K)(vii)</p>	<p>Intratec TEC-9</p>	 A black silhouette of an Intratec TEC-9 subcompact handgun, shown from a side profile. It is distinguished by its perforated barrel and a vertical magazine.





<p>(K)(vii)</p>	<p>Intratec TEC- DC9</p>	
<p><b>(K)(viii) IWI Galil Ace pistol, UZI PRO pistol.</b></p>		
<p>(K)(viii)</p>	<p>IWI Galil ACE with folding pistol brace</p>	
<p>(K)(viii)</p>	<p>IWI UZI PRO with folding stabilizing brace (extended)</p>	

<b>(K)(ix) Kel-Tec PLR 16 pistol.</b>		
<b>(K)(ix)</b>	Kel-Tec PLR 16	
<b>(K)(x) All MAC types, including the following:</b>		
<b>(K)(x)(I) MAC-10.</b>		
<b>(K)(x)(I)</b>	MAC-10	  (Cobray M-10 pictured)



<b>(K)(x)(II) MAC-11.</b>		
<b>(K)(x)(II)</b>	<b>MAC-11</b>	 <p>(Cobray M-11/Nine pictured)</p>
<b>(K)(x)(III) Masterpiece Arms MPA A930 Mini Pistol, MPA460 Pistol, MPA Tactical Pistol, and MPA Mini Tactical Pistol.</b>		
<b>(K)(x)(III)</b>	<b>Masterpiece Arms MPA930 Mini Pistol</b>	

<p>(K)(x)(III)</p>	<p>Masterpiece Arms MPA460 Pistol</p>	 A black and white photograph of a Masterpiece Arms MPA460 Pistol. The handgun is shown from a side profile, facing left. It features a compact, rectangular slide with a textured top surface and a series of small, circular markings. The frame is dark, and the grip is ergonomically shaped. A small, light-colored rectangular mark is visible on the right side of the slide.
<p>(K)(x)(III)</p>	<p>Masterpiece Arms MPA Tactical Pistol</p>	 A black and white photograph of a Masterpiece Arms MPA Tactical Pistol. The handgun is shown from a side profile, facing right. It has a more robust, tactical design with a prominent, long barrel. The slide is dark and features a textured top surface. The grip is thick and textured for enhanced handling.



<p>(K)(x)(III)</p>	<p>Masterpiece Arms MPA Mini Tactical Pistol</p>	
<p>(K)(x)(III)</p>	<p>Masterpiece Arms MPA30T</p>	

<b>(K)(x)(IV) Military Armament Corp. Ingram M-11.</b>		
<b>(K)(x)(IV)</b>	Military Armament Corp. Ingram M-11	
<b>(K)(x)(V) Velocity Arms VMAC.</b>		
<b>(K)(x)(V)</b>	Velocity Arms VMAC9	

<b>(K)(xi) Sig Sauer P556 pistol.</b>		
(K)(xi)	Sig Sauer P556 pistol	
<b>(K)(xii) Sites Spectre.</b>		
(K)(xii)	Sites Spectre HC	
<b>(K)(xiii) All Thompson types, including the following:</b>		
<b>(K)(xiii)(I) Thompson TA510D.</b>		
(K)(xiii)(I)	All Thompson types: Thompson TA510D (with 10 round drum magazine)	

<b>(K)(xiii)(II) Thompson TA5.</b>		
<b>(K)(xiii)(II)</b>	All Thompson types: Thompson TA5 (with 50 round drum magazine)	
<b>(K)(xiv) All UZI types, including Micro-UZI.</b>		
<b>(K)(xiv)</b>	All UZI types, including Micro-UZI (pictured with stock/brace folded)	



<p><b>(L) All of the following shotguns, copies, duplicates, variants, or altered facsimiles with the capability of any such weapon thereof:</b></p>		
<p><b>(L)(i) DERYA Anakon MC-1980, Anakon SD12.</b></p>		
<p>(L)(i)</p>	<p>DERYA Anakon MC-1980</p>	 <p>Pictured: Derya Arms, Anakon semiautomatic shotgun, model number unknown</p>
<p>(L)(i)</p>	<p>DERYA Anakon SD-12</p>	 <p>Note: Derya Arms is a Turkish firearms manufacturer. There is no evidence of production of a model SD-10. Pictured is a Hatsan Arms (another Turkish manufacturer), model Escort SD12, semiautomatic shotgun.</p>
<p><b>(L)(ii) Doruk Lethal shotguns.</b></p>		
<p>(L)(ii)</p>	<p>Doruk Lethal series (Lethal-1 pictured)</p>	
<p><b>(L)(iii) Franchi LAW-12 and SPAS 12.</b></p>		
<p>(L)(iii)</p>	<p>Franchi LAW-12</p>	

(L)(iii)	Franchi SPAS 12	
<b>(L)(iv) All IZHMAH Saiga 12 types, including the following:</b>		
<b>(L)(iv)(I) IZHMAH Saiga 12.</b>		
(L)(iv)(I)	IZHMAH Saiga 12	
<b>(L)(iv)(II) IZHMAH Saiga 12S.</b>		
(L)(iv)(II)	IZHMAH Saiga 12S	
<b>(L)(iv)(III) IZHMAH Saiga 12S EXP-01.</b>		
(L)(iv)(III)	IZHMAH Saiga 12S EXP-01	

<b>(L)(iv)(IV) IZHMAH Saiga 12K.</b>		
<b>(L)(iv)(IV)</b>	All IZHMAH Saiga 12 types: Saiga 12K	
<b>(L)(iv)(V) IZHMAH Saiga 12K-030.</b>		
<b>(L)(iv)(V)</b>	All IZHMAH Saiga 12 types: Saiga 12K 030	
<b>(L)(iv)(VI) IZHMAH Saiga 12K-040 Taktika.</b>		
<b>(L)(iv)(VI)</b>	All IZHMAH Saiga 12 types: Saiga 12K 040 Takita	
<b>(L)(v) Streetsweeper.</b>		
<b>(L)(v)</b>	(Cobray) Streetsweeper	

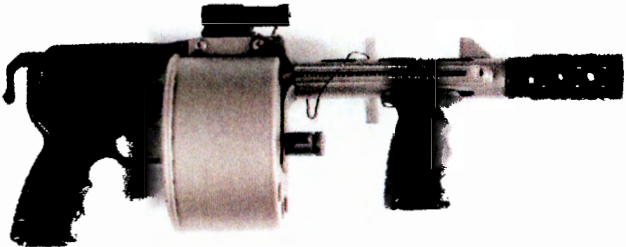
<b>(L)(vi) Striker 12.</b>		
(L)(vi)	(Penn Arms) Striker 12	



### Semiautomatic Rifles – Feature Flowchart

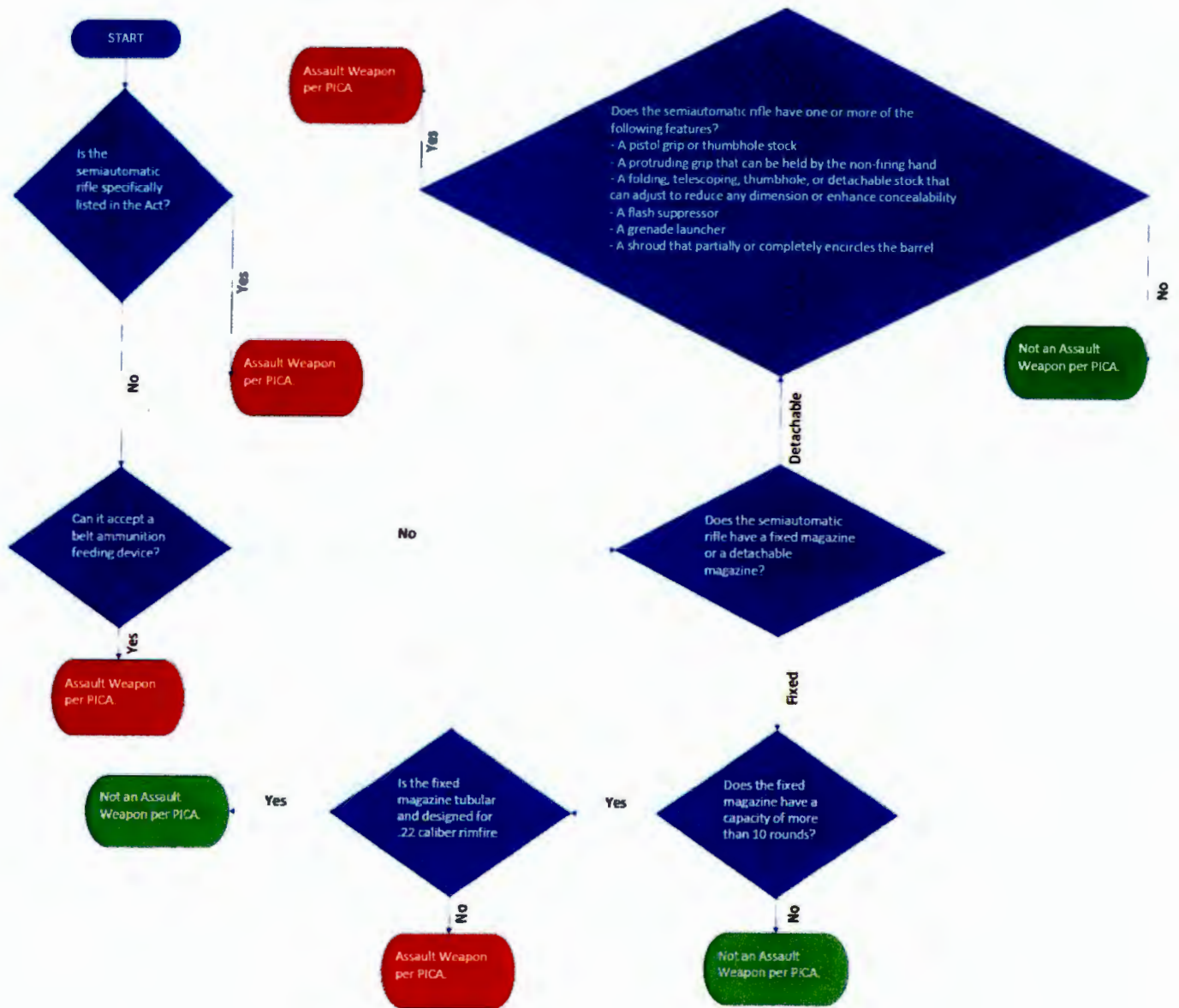

### Semiautomatic Pistols – Feature Flowchart

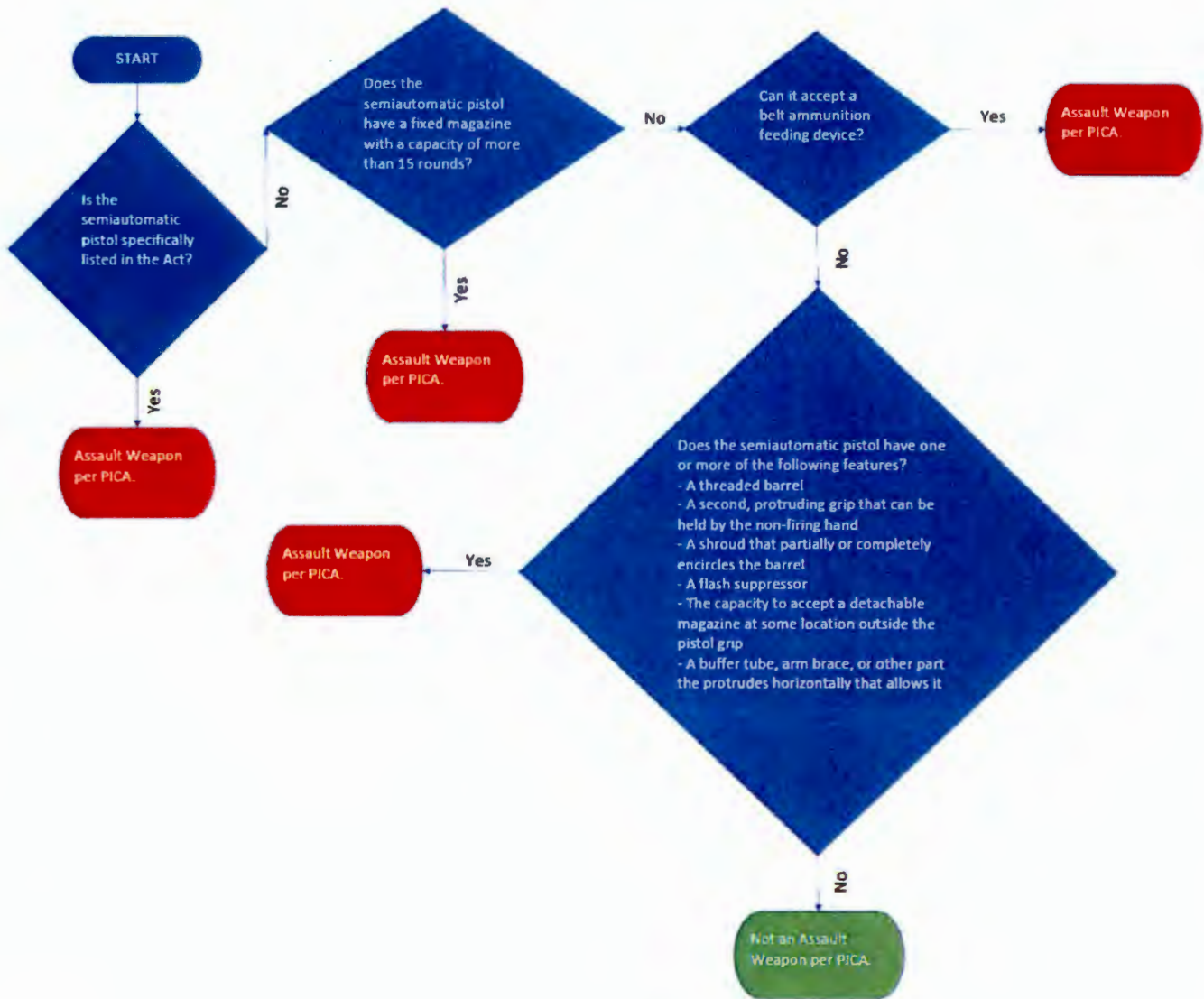

### Shotguns – Feature Flowchart

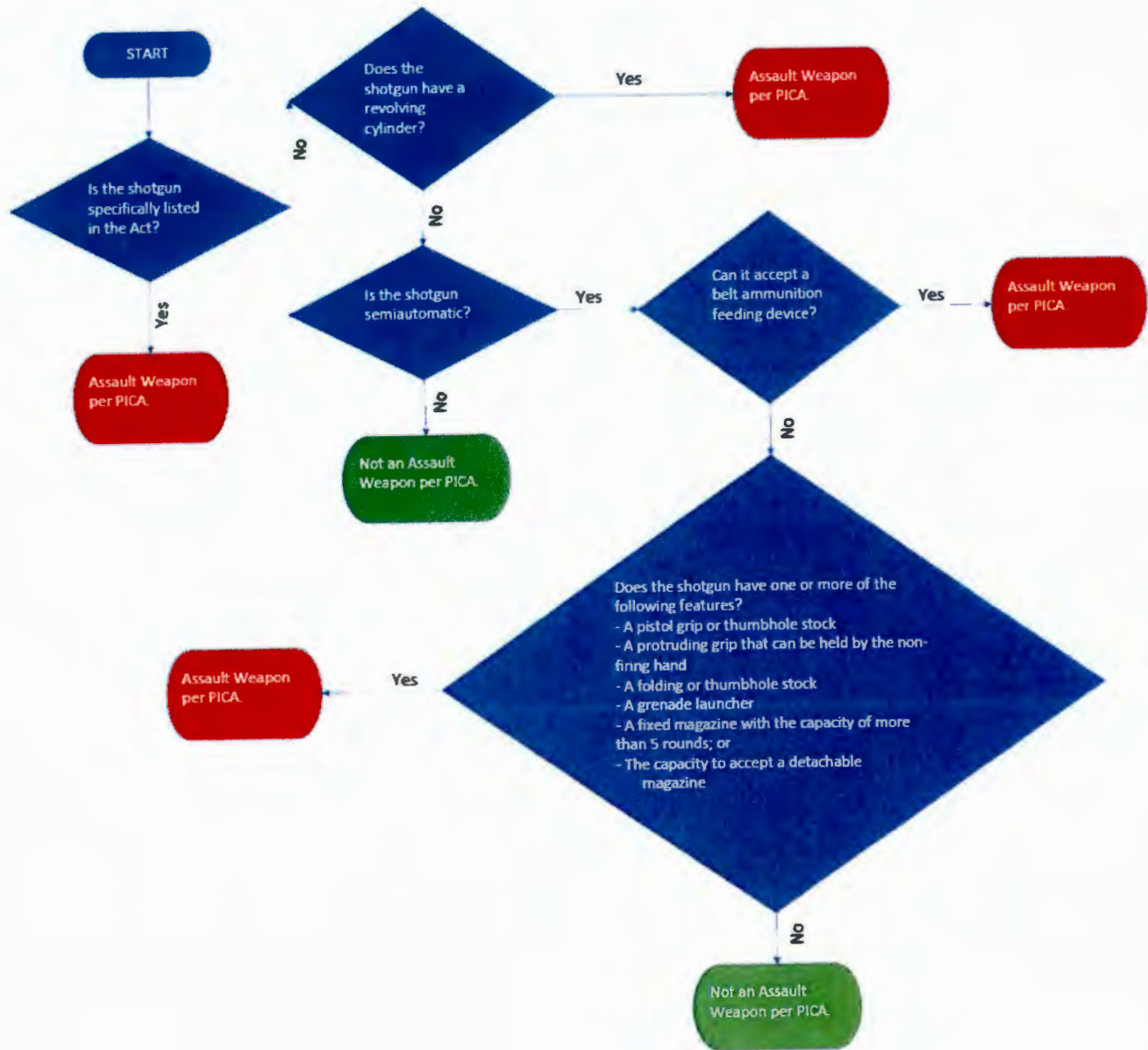





# Exhibit B-11



LONG GUNS PISTOLS UPPIERS LOWERS PARTS & ACCESSORIES SPECIALS **IM-STOCK** SEARCH ROCK RIVER ARMS SIGN UP LOG IN

## TACTICAL COMP LAR-47



AK1275 WITH RRA QUAD RAIL FREE FLOAT HANDGUARD

SPECIFICATIONS	ROCKOTE COLORS / FINISHES	
CALIBER:	7.62X38MM	BOLT CARRIER GROUP: CHROMED 7.62X38MM
LOWER RECEIVER:	RRA PROPRIETARY FORGED LAR-47	MAG RELEASE: AMBIDEXTROUS MAB RELEASE
UPPER RECEIVER:	RRA PROPRIETARY FORGED A4	HANDGUARD: RRA QUAD RAIL FREE FLOAT, CAR LENGTH
BARREL:	16-INCH CHROME LINED M4R, 1:10 RH TWIST	BUTTSTOCK: RRA OPERATOR CAR STOCK
MUZZLE DEVICE:	RRA OPERATOR BRAKE / 5/8-24 THREAD	PISTOL GRIP: RRA NSP OVERMOLDED PISTOL GRIP
GAS BLOCK:	RRA FLIP FRONT SIGHT GAS BLOCK ASSEMBLY	WEIGHT: 7.8 POUNDS
TRIGGER:	RRA TWO STAGE	LENGTH: 34 INCHES / 37.5 INCHES EXTENDED
TRIGGER GUARD:	RRA WINTER TRIGGER GUARD	INCLUDES: ONE AK MAGAZINE, CASE, MANUAL AND WARRANTY INFORMATION

66°F Sunny

Search



8:23 / 10/2/23



# Exhibit B-12

### HOW TO UPGRADE YOUR AR-15

We've built dozens of AR's and we'll cover all the best AR-15 upgrades such as handguards, triggers, BCGs, gas blocks, and more.

- AR-15
  - Beginner's Guide to Guns
  - Concealed Carry
  - Ammo & Reloading
  - Gunsmithing
  - Gun Laws by State
  - Concealed Carry Laws
  - Survival
  - Women
  - SEE ALL GUIDES
- MOST POPULAR
  - How to Upgrade Your AR-15
  - How to Upgrade Your Glock
  - How to Assemble an AR-15 Upper
  - How to Assemble an AR-15 Lower
  - How to Reload Ammo
  - How to Choose a Holster
  - How to Choose a CCW Handgun
  - How to Upgrade Your Ruger
  - SEE ALL GUIDES

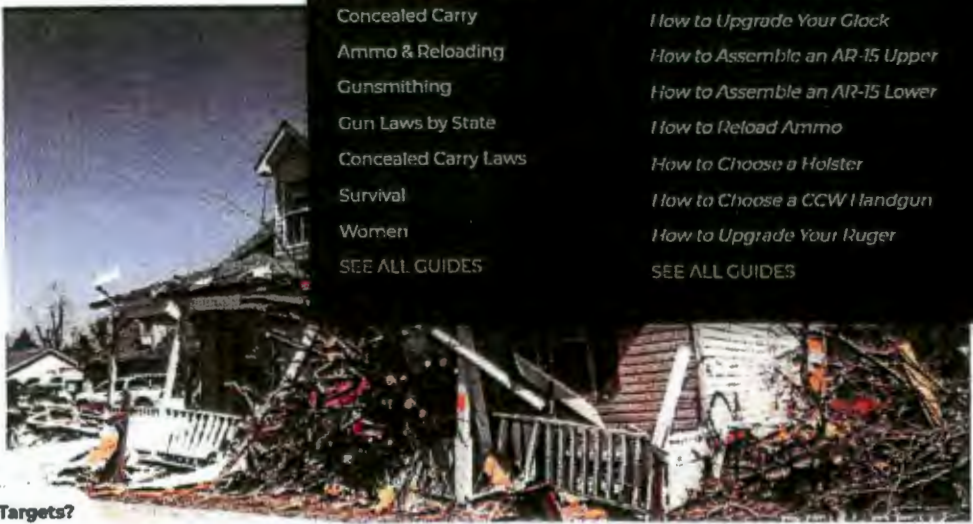

Want Free Practice Targets?  
Get our 9 favorite targets and drills

## [How-To] Survive a Tornado: Tips to

ps://www.pewpewtactical.com/#

TRIES

BEST HAMMER-FIRED HANDGUNS

Best Hammer-Fired Pistols

SEP 21, 2023

VIEW MORE

Most Popular

5 Best Home-Defense Shotguns of 2023: Tactical, Pump & Semi-Auto

9 Best Concealed Carry Guns in 2023: 9mm, .45 ACP, & More

DEPOSITION EXHIBIT

12



MILITARY-GRADE  
CBRN PROTECTION



NOW AVAILABLE  
FOR CIVILIANS

MIRA  
SHOP NOW

AR-15 Rifles [The Definitive Resource]

## AR-15 Rifles [The Definitive Resource]



The AR-15 is America's most popular sporting rifle. And because of that, there's dozens of reputable manufacturers, tons of options, and thousands of accessories.

Whether you're looking for the perfect AR-15 as a first-time buyer, or just the perfect upgrades and optics...you're in the right place.

### The Modern AR-15

It used to be really easy...head down to your local gun shop and choose from the 2 or 3 AR's they had on the shelf. But those days are long gone.

Now you're bombarded with **TOO** many choices...

But if you do your homework (with us), you'll be rewarded with the perfect AR-15 to fit your budget, purpose, and look.

Want Free Practice Targets?

JUMP TO SECTION

### SUMMARY OF OUR TOP PICKS



**HIGH-END PICK**  
**Daniel Defense DDM4 V7**

\$1907 at Daniel Defense

Our favorite high-end AR-15 that's built like a tank and battle proven.

[Jump to Details](#)



**ENTRY LEVEL PICK**  
**Palmetto State Armory (PSA) Complete AR-15s**

\$499 at PSA

Most affordable AR-15 that goes boom when needed.

[Jump to Details](#)



**ALSO GREAT HIGH-END PICK**  
**BCM Recce-16 MCMR AR-15**

\$1559 at Brownells

Save a little from the DD and go with a BCM, but seldom in stock.

[Jump to Details](#)



**CLASSIC PICK**  
**FN 15 Patrol Carbine**

\$1299 at Palmetto State Armory

Nicely made with quadrail, FSB, and mil-spec furniture.

[Jump to Details](#)



**BUDGET PICK**  
**Smith & Wesson M&P15 Sport II 5.56 NATO**

\$640 at CrabAGun

What you'll find in most gun stores and sells like hotcakes.

[Jump to Details](#)



**LAW ENFORCEMENT PICK**  
**Colt LE6920 AR-15**

\$1099 at Palmetto State Armory

From Colt.enough said.

[Jump to Details](#)



**[How To] Clean and Lube an AR-15!**  
[SUBSCRIBE](#)

**Deals of the Day:**  
Hand-Picked Ammo & Firearm Discounts



**TIPPMANN ARMS AR FLIP UP SIGHTS - \$20.00**

SEP 28 2023 [SEE ALL DEALS](#)

Want Free Practice Targets?

# Exhibit B-13

9/26/23, 3:30 PM

PSAK-47 GF5 Forged Classic Rifle, Redwood | Palmetto State Armory



DAILY DEALS

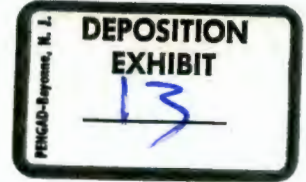

HOME / AK-47 / PSAK-47 GF SERIES / PSAK-47 GF5 / PSAK-47 CLASSIC RIFLES / PSAK-47 GF5 FORGED CLASSIC RIFLE, REDWOOD

IN STOCK ▶

### PSAK-47 GF5 FORGED CLASSIC RIFLE, REDWOOD

IN STOCK ▶

## PSAK-47 GF5 FORGED CLASSIC RIFLE, REDWOOD



\$1,029.99

- 1 +

ADD TO CART

PRODUCT MANUAL

Handling firearms or firearms parts can expose you to lead and other petroleum products known to the State of California to cause cancer, birth defects, or other reproductive harm. Wash hands thoroughly after handling. For more information go to [www.p65warnings.ca.gov](http://www.p65warnings.ca.gov) (CA Health and Safety Code Section 25249.6).

Customers must read Compliance Information before purchasing.

SKU 5655104080

Model Number 5655104080



Palmetto State Armory



9/26/23, 3:30 PM

PSAK-47 GF5 Forged Classic Rifle, Redwood | Palmetto State Armory

UPC

5655104080

**DAILY DEALS**



Add to Compare

Share:

Norton SHOPPING GUARANTEE [Learn more](#)

### CUSTOMER GALLERY



## PRODUCT DETAILS

### DETAILS

FN Cold Hammer Forged Chrome Moly Vanadium Steel Barrel; Chrome Lined

Stamped Steel Receiver

Blended Hammer Forged 4340 Aircraft Quality Front Trunnion

Hammer Forged Bolt

Hammer Forged Carrier

Side Scope Mount

Enhanced Extended Safety Lever

7.62x39 Caliber

1 in 9.5" Twist

Thread Pitch: M14x1LH

Std. 800-yard rear sight leaf



» Wood Furniture



9/26/23, 3:30 PM

PSAK-47 GF5 Forged Classic Rifle, Redwood | Palmetto State Armory

ALG AKT Enhanced Trigger With Lightning Bow



30 round magazine (1); Where allowed by law

**DAILY DEALS**

The PSA GF5 AK-47 was designed from the ground up to create a new standard in AK-47 rifles, utilizing all new enhanced precision manufactured parts. Thoroughly tested in development, we tortured tested to 10,000 rounds to ensure a quality product. Not to be satisfied with just a good AK-47, we kept improving and now are proud to announce our PSAK-47 Gen5 Hammer Forged (GF5) rifle with a hammer-forged barrel, bolt, carrier, and front trunnion.

The barrel is a proprietary blend of hammer-forged chrome-moly vanadium made by FN that is referred to as "Machine Gun Steel" by virtue of its use in FN's M249 and M240 weapons. The hammer forging process work hardens the steel, making it more durable. This 16" barrel is magnetic particle inspected, to ensure quality and dependability and is pressed into a hammer forged 4340 AQ front trunnion to ensure the longevity AK-47's are known for. The hardened steel 1mm receiver features an ALG AKT Enhanced Trigger with Lightning Bow, and side rail mount. The front trunnion and bolt carrier are engraved with GF5 to designate the new GF5 hammer-forged model. The rifle is finished with a classic red wood handguard, stock, and grip. This rifle ships with 30 round magazine (where allowed by law).

Rifles must be shipped to a valid, current Federal Firearms Licensee (FFL). Please have the shipping address of your preferred FFL before placing your order. You will need the FFL information to complete the order. It is the purchaser's responsibility to be aware of the laws in their state regarding high capacity sporting rifles.

- As we are transitioning to Soviet Arms, your receivers may be stamped with our new AK Soviet Arms logo on firearms manufactured after 3/8/2023. This will not affect the quality or function of the firearm as they are the same AK receivers used for our AK's. This will only be a minor cosmetic change moving towards our Soviet Arms AK's.





9/26/23, 3:30 PM

PSAK-47 GF5 Forged Classic Rifle, Redwood | Palmetto State Armory

**REASONS TO BUY**

**DAILY DEALS**



**PSAK-47 GF5**  
**FN BARREL,  
 CLEANING ROD, ALG  
 TRIGGER**

**PSAK-47 GF5**  
**FN BARREL,  
 CLEANING ROD, ALG  
 TRIGGER**

Not to be satisfied with just a good AK-47, we kept improving and now are proud to announce our PSAK-47 Gen5 Hammer Forged (GF5) rifle with a hammer-forged barrel, bolt, carrier, and front trunnion.



**FN Hammer Forged Chrome-moly Vanadium Barrel**

The GF5 features an upgraded barrel that is referred to as "Machine Gun Steel" due to its use in FN's M249 and M240 platform.

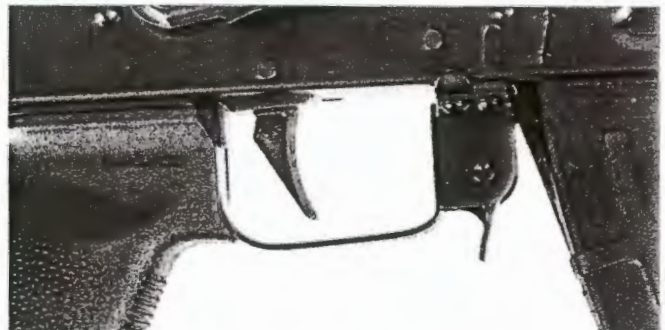

**ALG AKT Enhanced Trigger**

Upgraded trigger for a smooth and crisp pull.



9/26/23, 3:30 PM

PSAK-47 GF5 Forged Classic Rifle, Redwood | Palmetto State Armory

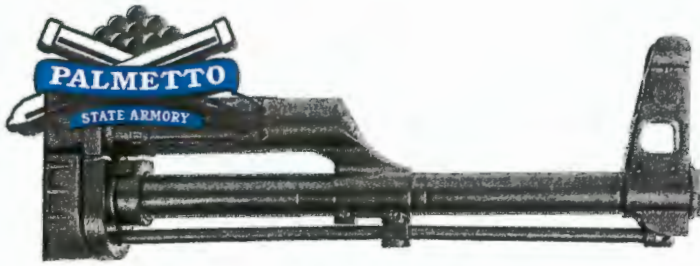

### Gas Block and Cleaning Rod

45 Degree Gas block with additional cleaning rod.



### Side Mount

Traditional side rail for an optic mount - Midwest, RS Regulate recommended. Side rails vary GREATLY between countries, so mounts can be finicky due to large tolerances, which is why we recommend certain mounts.



### Sling Mount

Traditional AK sling mount whether mounting a com bloc-style sling or modern sling.



### Spring and Bolt

Piston operated system with recoil assembly. Hammer Forged Carrier, Bolt and Trunnion. This is the heart of the gun where wear happens. We are one of the few companies that does it correctly and has emulated com-bloc guns with Hammer Forged bolt, carrier and trunnion, and gone even further with our AQ4340 trunnion for even more durability.



### Front Sight Base



front sight base with cleaning rod lock up point with front brake.

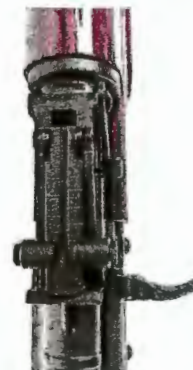

### Sight Leaf

Standard 800-yard rear sight leaf.





9/26/23, 3:30 PM

PSAK-47 GF5 Forged Classic Rifle, Redwood | Palmetto State Armory



**DAILY DEALS**

Search reviews...



Sort by: Most Recent

May 1, 2023



Red wood AK 47 GF5.



Fast shipping.....Str8 out of Box 300+ rounds , no issues.. pretty accurate. Smooth awesome wood finished. You,re gonna love ALG AKT Enhanced Trigger.... FAST .. 4 A little more \$ ...WORTH the upgrade from Gf3.... gREAT Job PSA. would of given 5 stars if it came with 2 mags ...

Show details

Mar 21, 2023



Solid rifle, minor cosmetic flaws.



Solid rifle, excellent trigger, furniture is mostly gorgeous. Finish is mostly excellent. Shoots great. Headspaced correctly.

Issues I have are the flathead screws that hold on the grip and the stock are stripped by the factory. Kinda ugly on an otherwise beautiful rifle. The front hand... [Read More](#)

Show details

Feb 26, 2023



This gun is beautiful and shoots well out of the box.

Show details



9/26/23, 3:30 PM

PSAK-47 GF5 Forged Classic Rifle, Redwood | Palmetto State Armory

Appears to operate at an acceptable level

**DAILY DEALS**



Oct 14, 2022



Love this gun



Really build well and works great so far, only put a few hundred rounds through it so far but no problem at all.

Show details

Aug 18, 2022



Another PSA winner!



My first AK, and it is a beauty! I have a number of plastic and wood furnished firearms, but I just love a nice wood grain. Very solid, fit and finish is tip top. Off to the range today, first three shot group off the bench at 50 yards was ~ 1 1/8" group about 7" high. Two front sight post...

[Read More](#)

Show details

BACK

NEXT >

## QUESTIONS & ANSWERS



Be the first to ask a question about this product

Sort by: Most Common

### QUESTION:

Can this be offered in a 12.5 barrel pistol format with a triangle folding brace please?



About

**PSAK-47 GF5 Forged CHF Classic ALG Rifle, Black**

Asked by Jorge R on Jan 9, 2021

Was this question helpful? Yes (42)

Answer



9/26/23, 3:30 PM

PSAK-47 GF5 Forged Classic Rifle, Redwood | Palmetto State Armory

QUESTION:



**DAILY DEALS**

Tree wood. It's the best type of wood.

Posted by Ryan B on Sep 14, 2022 purchased Jan 10, 2021 [Reply](#) [Inaccurate](#) \*\*\*

Was this question helpful? **Yes (6)**

[See 2 answers](#) [Answer](#)

QUESTION:

Can you add a featureless grip for us in California for this model?

Asked by Richard E on Aug 20, 2021

**BEST ANSWER:**

The questions here aren't checked by PSA and are only answered by customers.

Posted by Brian P. on Dec 13, 2022 [Reply](#) [Inaccurate](#) \*\*\*

Was this question helpful? **Yes (6)**

[Answer](#)

QUESTION:

4th PSAK I've purchased and all came with mags. Any reason this GF5 did not?

Asked by A shopper on Feb 9, 2021

**BEST ANSWER:**

My GF5 came with a 30 round PMAG. Do you live in a magazine capacity restricted state? That might be why

Posted by Mohibullah S. on Mar 4, 2021 purchased Feb 3, 2021 [Reply](#) [Inaccurate](#) \*\*\*

Was this question helpful? **Yes (4)**

[See 2 answers](#) [Answer](#)

QUESTION:

What magazines have you tested with this? Can I use surplus or just Magpul?

Asked by Mark F on Jan 11, 2021

**BEST ANSWER**

Most quality steel and polymer magazines will work with our AK's. Some may require minor fitment as they were made in various com-bloc countries.

Best Regards,  
PSA Customer Service.

Posted by Josiah M. **STAFF** on Jan 12, 2021 [Reply](#) [Inaccurate](#) \*\*\*

Was this question helpful? **Yes (2)**



9/26/23, 3:30 PM

PSAK-47 GF5 Forged Classic Rifle, Redwood | Palmetto State Armory

QUESTION:

When will the PSAK-47 GF5 be available again?

DAILY DEALS



Mar 24, 2021

BEST ANSWER:

typically every week day.. check at 4pm EST

Posted by Corey F. on Mar 26, 2021 purchased Jan 7, 2021 [Reply](#) [Inaccurate](#) ...

Was this question helpful? Yes (1)

[Answer](#)

[BACK](#) [NEXT >](#)

RETAIL STOCK



 Please note that stock-status may differ from what is represented below.  
Please call to verify actual stock-status before arriving to store.  
Please read all our Terms & Conditions for [Retail Firearm Transfers](#).

VISIT US IN STORE





9/26/23, 3:30 PM

PSAK-47 GF5 Forged Classic Rifle, Redwood | Palmetto State Armory

**OUT OF STOCK**



**Palmetto State Armory**  
 & Range  
 3760 Fernandina Rd  
 Ridgeland, SC 29936  
 (843) 379-4867

**MORE INFO**

**OUT OF STOCK**

**Columbia - Store & Range**  
 3760 Fernandina Rd  
 Columbia, SC 29210  
 (803) 551-2680

**MORE INFO**

**OUT OF STOCK**  
**DAILY DEALS**

**Greenville - Store & Range**  
 1040-A Woodruff Rd  
 Greenville, SC 29607  
 (864) 605-6680

**MORE INFO**

**OUT OF STOCK**

**Summerville - Store & Ran...**  
 366 E. 5th North Street  
 Summerville, SC 29483  
 (843) 900-9000

**MORE INFO**

## COMPLIANCE

### Shipping Restrictions

It is the customer's responsibility for understanding state laws regarding all purchases made. For a comprehensive list of all Shipping Restrictions, please refer to our Shipping Restrictions By State Page found [Here](#).

### All NFA Rules Apply

These items are controlled by the U.S. Government and authorized for export only to the country of ultimate destination for use by the ultimate consignee or end-user(s) herein identified. They may not be resold, transferred, or otherwise disposed of, to any other country or to any person other than the authorized ultimate consignee or end-user(s), either in their original form or after being incorporated into other items, without first obtaining approval from the U.S. government or as otherwise authorized by U.S. law and regulations.

Magazines will be removed from firearms when shipping to states with magazine capacity restrictions.

Handling firearms or firearms parts can expose you to lead and other petroleum products known to the State of California to cause cancer, birth defects, or other reproductive harm. Wash hands thoroughly after handling. For more information go to [www.p65warnings.ca.gov](http://www.p65warnings.ca.gov) (CA Health and Safety Code Section 25249.6).

## WARRANTY



9/26/23, 3:30 PM

PSAK-47 GF5 Forged Classic Rifle, Redwood | Palmetto State Armory



# AMERICAN MADE. FOR LIFE.



## FULL LIFETIME WARRANTY.

Palmetto State Armory firearms are covered by an industry leading **FULL LIFETIME WARRANTY**. This extends beyond the original purchaser. We want the person who bought a great quality firearm at an excellent price to have comfort in knowing that no matter what, the firearm can be fixed at no additional cost.

THIS INCLUDES SHIPPING BOTH WAYS.

We strive for excellence all the way through production and hope customers never have to use this warranty but we also pride ourselves in 99% non-repair/return ratio. It is there for peace of mind so that the consumer can be confident in their purchase. Should the consumer ever need to contact us regarding a repair under the warranty, simply use our [contact form](#) or give us a call at [877-560-7229](tel:877-560-7229).

Palmetto State Armory firearms and parts are backed by our Full Lifetime Warranty. Our PSA firearms and parts are warranted to be free from defects in materials and craftsmanship for the serviceable lifetime of the firearm or part. All Palmetto State Armory barrels are machined and guaranteed to be concentric with the bore of our barrels.

### For the Life of our product

The liability of Palmetto State Armory under this warranty shall be limited solely to the obligation to repair or replace the firearm/part or defect at its discretion, and to pay transportation and insurance charges for return of the firearm to the owner for a rightful warranty claim. This warranty is transferable for the serviceable lifetime of the firearm or part. Modification of firearm will void this warranty. This warranty does not cover normal wear or any damage resulting from careless handling, neglect, repairs and adjustments, corrosion, improper, substandard or defective ammunition.

### What we don't cover

Under no circumstances shall Palmetto State Armory be responsible for incidental or consequential damages with respect to economic loss or injury to property, whether as a result of express or implied warranty, negligence or otherwise. Some states do not allow the exclusion or limitation of incidental or consequential damages, so the above limitation may not apply to you. Palmetto State Armory will



9/26/23, 3:30 PM

PSAK-47 GF5 Forged Classic Rifle, Redwood | Palmetto State Armory

not be responsible for the results of careless handling, unauthorized adjustments, defective, low-quality, reloaded, or improper ammunition. ~~WARRANTY~~ corrosion, neglect, ordinary wear and tear, or unreasonable use.



### Initiating a claim

To initiate a Warranty claim, call Palmetto State Armory Customer Service:

**Hours:** Monday through Friday, 9am - 5pm EST

**Email:** [Contact Form](#)

1. Customer service will issue an RMA number to allow for the return of the firearm.
2. Warranty claims must have this RMA filled out, and included in the box with the firearm or part.
3. The firearm or part concerned must be shipped using the prepaid label our representative emails to you.

Palmetto State Armory will pay shipping and insurance charges for the return of a firearm or part to its owner or FFL, if the related claim is a proper claim for warranty work. If Palmetto State Armory is unable to fix the original serial number, a new one will be sent out, but must go to an FFL for transfer back to the customer. Another background check will be completed at the time of transfer. Palmetto State Armory is not responsible for transfer fees at the FFL.

**DOWNLOAD REPAIR REQUEST FORM**



### AMENDMENT II

*A well regulated Militia, being necessary to the security of a free State, the right of the people to keep and bear Arms, shall not be infringed.*





9/26/23, 3:30 PM

PSAK-47 GF5 Forged Classic Rifle, Redwood | Palmetto State Armory



DAILY DEALS

Questions? Need help? Call us: [\(877\) 560-7229](tel:(877)560-7229)



About SSL Certificates



COMPANY	INFO	LEGAL	CONTACT INFORMATION
<a href="#">Blog</a>	<a href="#">Check Shipping Status</a>	<a href="#">Terms &amp; Conditions</a>	Palmetto State Armory 3760 Fernandina Rd. Columbia, SC 29210
<a href="#">Careers</a>	<a href="#">My Account</a>	<a href="#">Retail Return Policy</a>	
<a href="#">About PSA</a>	<a href="#">Contact Us</a>	<a href="#">Full Lifetime Warranty</a>	
<a href="#">Affiliate Program</a>	<a href="#">Rebates &amp; Promotions</a>	<a href="#">Shipping Restrictions</a>	<b>HELP CENTER</b>
<a href="#">Retail Stores</a>	<a href="#">Compare Products</a>	<a href="#">Privacy Policy</a>	
<a href="#">Defense Courses</a>	<a href="#">Check Order Status</a>	<a href="#">Sitemap</a>	
<a href="#">SC CWP Info</a>	<a href="#">Gift Card Balance</a>		
<a href="#">Shoot ResponsiblyFAQ</a>			
<a href="#">Forum</a>	<a href="#">Buying a Gun Online</a>		
<a href="#">The Gathering</a>	<a href="#">FFL Locator</a>		
	<a href="#">Product Manuals</a>		
	<a href="#">California Buying Guide</a>		

© 2023 PALMETTO STATE ARMORY. ALL RIGHTS RESERVED.

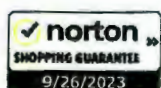



9/26/23, 3:30 PM

PSAK-47 GF5 Forged Classic Rifle, Redwood | Palmetto State Armory

# Exhibit B-14

ARFCOM BRAVO COMPANY USA Cmmg TNVC Trijicon DANIEL DEFENSE LIGHTWEIGHT. HEAVY-DUTY. RIS III. LEARN MORE Login Register

Discussion Forums Firearm Resources Equipment Exchange Virtual Build Gear Deals ARFCOM Shop BPW Podcast 6167 Online

- AR-15
- AK-47
- Handgun
- Precision Rifles
- Armory
- Training
- Competitive Shooting
- General
- Outdoors
- Archery
- Hometown
- Industry
- Archives

SILENCER SHOP AIM DEL-TON CAPITAL ARMORY SILENCERS TO YOUR DOOR DOUBLESTAR FIGHTLITE SOS IMPORTS MIDWEST PALMETTO STATE ARMORY TROY  
 PRIMARY ARMS BROWNELLS RIFLESPEEC HITMAN LaRue VORTEX SKD irh night vision MISSION FIRST

WIN GIVEAWAY  
 LOW FOR A  
 TO WIN A  
**GENT**  
 3MM | 6.5  
 VALUE  
 ENTER NOW  
 Titanium Cerakote

CLICK HERE FOR DEALS

AMMO SALE!  
 FEDERAL  
 American Eagle  
 223 REM 55 GRAIN

FREE SHIPPING ON ALL ORDERS OVER \$99

ECHELON

ps://www.ar15.com/forums/b/4\_AK\_47.html

DEPOSITION EXHIBIT  
 14



AR-15

Site Notices

GUNSTOCK 2023 - (DFW Range Event!)

Basics

Forum	Stats	Last Post
New AR Products Previews of New Guns and Gear!	Topics: 1685 Replies: 64763	9/25/2023 10:25 AM Green0
AR Basics Learn About The AR Platform	Topics: 3373 Replies: 48711	9/23/2023 1:36 AM Eric2340
AR Discussions AR Specific Discussions	Topics: 171087 Replies: 2768152	9/25/2023 3:54 PM MackDaddy1962
AR Piston Systems	Topics: 6081 Replies: 70851	9/25/2023 10:56 AM Razzman1





Topic	Replies	Views	Last Post
New AR Products Reviews of New Guns and Gear!	Topics 1495 Replies 6183		9/25/2023 10:12 AM by Green6
AR Basics Learn About The AR Platform	Topics 3373 Replies 42711		9/25/2023 1:26 AM by 642299
AR Discussions AR Specific Discussions All Other Systems	Topics 27607 Replies 208839		9/25/2023 4:16 PM by Gammawing
AR Builds Dedicated Forum For AR Builds	Topics 685 Replies 7091		9/25/2023 10:50 AM by Buzman11 pintrixbuilds.com
AR Mods AR Specific Discussions Accessories and Discussions On Classes	Topics 2542 Replies 39315		9/25/2023 2:59 PM by 564pghw/762
AR Builds Dedicated Forum For AR Builds	Topics 3973 Replies 4628		9/25/2023 3:49 PM by TRunner
AR Mods AR Specific Discussions Accessories and Discussions On Classes	Topics 1559 Replies 13649		9/24/2023 5:32 AM by CheChobin
AR Builds Dedicated Forum For AR Builds	Topics 2163 Replies 21845		9/25/2023 3:27 PM by JuddHawker
AR Mods AR Specific Discussions Accessories and Discussions On Classes	Topics 25 Replies 3294		9/25/2023 6:49 AM by Buzman11
AR Builds Dedicated Forum For AR Builds	Topics 2079 Replies 26285		9/25/2023 3:27 PM by JuddHawker
AR Mods AR Specific Discussions Accessories and Discussions On Classes	Topics 7379 Replies 75972		9/25/2023 2:48 PM by Sabalino
AR Builds Dedicated Forum For AR Builds	Topics 1818 Replies 5725		9/25/2023 7:03 AM by JuddHawker
AR Mods AR Specific Discussions Accessories and Discussions On Classes	Topics 1405 Replies 10743		9/24/2023 5:11 PM by catfish1
AR Builds Dedicated Forum For AR Builds	Topics 3029 Replies 40019		9/25/2023 6:57 AM by vrb309
AR Mods AR Specific Discussions Accessories and Discussions On Classes	Topics 1418 Replies 11798		9/25/2023 1:41 PM by Tazee

Windows taskbar area containing system tray icons (network, volume, battery), taskbar icons (Microsoft Edge, File Explorer, etc.), and a search bar with the text "Type here to search".



AR15.COM BRAVO COMPANY USA Cmmg TNVC TROCON TROY www.Troyind.com

Classroom Forums, Firearm Resources, Equipment Exchange, Virtual Build, Gear Daily, AR15.com Shop, IRW Podcast

PALMETTO STATE ARMORY, TROY, AAM, RIFLEHEADS, CALIBER, SKD, GEISSELE AUTOMATICS, PRIMARY ARMS, SPRINGFIELD ARMORY, BROWNELLS, BRAVO COMPANY USA, SILENCER SHOP, STS IMPORTS, irb night vision, FIGHTLITE

AR-15 > AR Basics

Notices

CUNSTOCK 2023 (DFW Range Event)

Considerations for First AR? (Page 1 of 2)

Previous Page Page 1 / 2 Next Page

IM86

Joined Apr 2023

Posts 1

EE 0%

FL, USA

Posted: 4/14/2023 9:54:51 AM EDT

I'm new to the site, and moving from NY to FL so thinking about getting an AR - well because I can. I'm a proficient hand gunner (IDPA), shot gunner (clays), and have a 10-22 that I enjoy plinking with. I'm thinking the AR will be primarily range - and friends encouraging me to try "3-gun". I'm not into doing a "build" at this point - just don't know enough. So have been poking around at what I can get in the \$1K range. I've looked at PSA site, S&W, Colt - but would like some input from more experienced folks those options as well as others to consider (and why please).

Thank you. I look forward to learning alot here and hope at some point I can contribute.

FROM NOW TILL DEC. 31, 2023, BUY ANY TM22 AND GET A FREE 25RD MAGAZINE.

CLICK HERE FOR DETAILS



Joined May 2003

Posts 59566

TX, USA

Posted: 4/14/2023 10:18:30 AM EDT

For the \$1k you really cant go much wrong with an LE prefix Colt Carbine.

Chrome lined bore, 4150 CMV steel, MPI bolt & Barrel, Shot peened bolt, properly staked gas key, etc.

You can get those things with other brands, but it all comes standard with Colt LE carbines.



Joined Aug 2001 TX, USA  
 Posts: 11289  
 EE: 100% (18)

Joined Aug 2019 TX, USA  
 Posts: 2060  
 EE: 100% (3)

Joined Jan 2021 USA  
 Posts: 465  
 EE: 6% (1)

Posted: 4/14/2023 10:21:55 AM EDT [92]  
 You are going to need at least 3 to start with. One with irons, one with a LPVO and one with a red dot. Go ahead with PSA first and a couple cases of ammo, At least 10 of each D&H mags and Magpul mags. You are going to need a chest rig to carry all your mags and extras too.

Posted: 4/14/2023 3:00:35 PM EDT [93]  
 Stick with name brand stuff. PSA, Aero, Colt, etc.  
 Most all of them come with standard features.  
 Don't buy some sketchy no-name or rebranded AR. Who knows what you're getting.

Posted: 4/14/2023 9:54:59 PM EDT [94]  
 Quote History  
 Originally Posted By \_DRC  
 For the \$1k you really cant go much wrong with an LE prefix Colt Carbine.  
 Chrome lined bore, 4150 CHV steel, MPI bolt & Barrel, Shot peened bolt, properly staked gas key, etc.  
 You can get those things with other brands, but it all comes standard with Colt LE carbines.

Top....  
 Congrats on getting out of NY



Considerations for first AR? - AF. x +

ar15.com/forums/AR-15/Considerations-for-first-AR-/128-779981/#i8547461



**BRAVO COMPANY USA** Log In Register

---

**MyKACFailed**  
 Signed: Apr 2023  
 Posts: 3  
 EE: 0% (0)

Vip.....  
 Congrats on getting out of NY

Posted: 4/14/2023 10:11:17 PM EDT [Last Edit: MyKACFailed] (#5)

You're going to get 1,000,000 opinions . . . prepare yourself.

As far as what has been recommended so far a Colt in 2023 is not at all what a colt in 2016 was. They are an assembly shop now (as opposed to a manufacturer). Although you're likely going to get a gun that is just fine, you won't be getting a "Colt" as far as what it was from prior decades.

I don't have a recommendation below \$1,000, but that doesn't mean there aren't plenty of good options. For my money a DI LWRC is the best bang for the buck AR out there (if you shop for them appropriately). I picked up a pair of them for \$1200 each. Upsides: Coated bolt, very high quality barrel, FULLY Ambi lower, adjustable tension screw. Fit and finish is exceptional, especially for forged receivers. The downside is that the handguard lengths are kinda weird and you can't play with them like you would legos, which with most ARs you can.

Good luck.

---

Posted: 4/14/2023 10:50:48 PM EDT [Last Edit: MvCapCop] (#6)

**\$700 Starter Pack**  
 colt: 16 mid length pencil 5.56 nato 1-7 nitride 15 lightweight or jmk upper with bog ch mbsc sight set \$399.99



**MvCapCop**  
 Signed: Jul 2007  
 Posts: 10766  
 EE: 100% (207)

Type here to search

USD... 3:22 PM 9/25/2023



ARFCOM BRAVO CMMG TNVC Tripcon  
 Discussion Forums Firearm Resources Equipment Exchange Virtual Build Gear Deals ARCom Shop BPW Podcast 6173 Online  
 LaRue TROY DEL-TON SKD GEISSELE AUTOMATICS FIGHTLITE SPS IMPORTS VALMET PALMETTO STATE ARMORY MISSION FIRST irb night vision BROWNELLS SPRINGFIELD ARMS SILENCER SHOP MIDWEST ARMS BRAVO VALLEY PRO USA CASBITOL ARMS

AK-47 AK Sponsor: PALMETTO STATE ARMORY

Notices  
 GUNSTOCK 2023 - (DPW Range Events)

Forum	Stats	Last Post
New AK Products Previews of New Guns and Gear!	Topics: 138 Replies: 4524	6/29/2023 5:24 PM MaoodI
AK Discussions AK Technical Discussions	Topics: 56970 Replies: 632806	9/26/2023 1:24 PM NWRRed
AK Reference	Topics: 835 Replies: 6567	8/28/2023 10:24 AM creechar
AK Pistols/SBR	Topics: 2539 Replies: 27386	9/26/2023 1:11 AM Shadyman
American Made. For Life.		palmettostatearmory.com
GaRi & Valmet Discussions	Topics: 1937 Replies: 12387	9/20/2023 6:52 PM nlcra
Build It Yourself	Topics: 12651 Replies: 77645	9/26/2023 7:30 AM pilatuspilot
Maintenance & Cleaning	Topics: 620 Replies: 4909	7/28/2023 8:08 AM Saber329
Ammunition	Topics: 4834 Replies: 49180	9/26/2023 12:50 PM Redman556
Magazines	Topics: 5586 Replies: 40932	9/19/2023 10:32 PM Shadyman
Optics & Accessories Mounts, Sights, Lights, etc.	Topics: 4560 Replies: 29372	9/18/2023 11:38 AM W_E_G
Troubleshooto	Topics: 1254	9/24/2023 6:02 PM

# Exhibit B-15

10/1/23, 8:52 AM

Ruger American® Rifle Predator



PISTOLS REVOLVERS RIFLES CUSTOM SHOP ACCESSORIES

FIREARM SEARCH Q



RUGER AMERICAN® RIFLE PREDATOR

RELIABILITY, VERSATILITY, PERFORMANCE AND AFFORDABILITY.

Model No.	Caliber	Capacity	Barrel Length	Stock	Magazine	Barrel Finish	Thread Pattern	Model Option	Suggested Retail	
6973	6.5 Creedmoor	4	22"	Moss Green Synthetic	Flush-Fit	Matte Black	5/8"-24	Right-Handed	\$619.00	<a href="#">Spec Sheet</a> ▶ <a href="#">Buy Now</a> ▶ <a href="#">Available</a>
6974	308 Win	4	18"	Moss Green Synthetic	Flush-Fit	Matte Black	5/8"-24	Right-Handed	\$619.00	<a href="#">Spec Sheet</a> ▶ <a href="#">Buy Now</a> ▶ <a href="#">Available</a>
16977	6.5 Creedmoor	4	22"	Moss Green Synthetic	Flush-Fit	Matte Black	5/8"-24	Left-Handed	\$709.00	<a href="#">Spec Sheet</a> ▶ <a href="#">Buy Now</a> ▶ <a href="#">Available</a>
26916	243 Win	4	22"	Moss Green Synthetic	Flush-Fit	Matte Black	5/8"-24	Left-Handed	\$709.00	<a href="#">Spec Sheet</a> ▶ <a href="#">Buy Now</a> ▶ <a href="#">Available</a>
26917	7mm-08 Rem	4	22"	Moss Green Synthetic	Flush-Fit	Matte Black	5/8"-24	Left-Handed	\$709.00	<a href="#">Spec Sheet</a> ▶ <a href="#">Buy Now</a> ▶ <a href="#">Available</a>
26918	308 Win	4	22"	Moss Green Synthetic	Flush-Fit	Matte Black	5/8"-24	Left-Handed	\$709.00	<a href="#">Spec Sheet</a> ▶ <a href="#">Buy Now</a> ▶ <a href="#">Available</a>
26922	6.5 Grendel	10	22"	Moss Green Synthetic	Metal AR-Style	Matte Black	5/8"-24	Right-Handed	\$669.00	<a href="#">Spec Sheet</a> ▶ <a href="#">Buy Now</a> ▶ <a href="#">Available</a>
26944	223 Rem	10	22"	Moss Green Synthetic	AR-Style	Matte Black	1/2"-28	Right-Handed	\$669.00	<a href="#">Spec Sheet</a> ▶ <a href="#">Buy Now</a> ▶ <a href="#">Available</a>
26971	204 Ruger	10	22"	Moss Green Synthetic	AI-Style	Matte Black	1/2"-28	Right-Handed	\$669.00	<a href="#">Spec Sheet</a> ▶ <a href="#">Buy Now</a> ▶ <a href="#">Available</a>
26973	6.5 Creedmoor	3	22"	Moss Green Synthetic	AI-Style	Matte Black	5/8"-24	Right-Handed	\$669.00	<a href="#">Spec Sheet</a> ▶ <a href="#">Buy Now</a> ▶ <a href="#">Available</a>
6945	22-250 Rem	4	22"	Moss Green Synthetic	Flush-Fit	Matte Black	1/2"-28	Right-Handed	\$619.00	<a href="#">Spec Sheet</a> ▶ <a href="#">Buy Now</a> ▶ <a href="#">Limited Availability</a>
26948	6mm Creedmoor	3	22"	Moss Green Synthetic	AI-Style	Matte Black	5/8"-24	Right-Handed	\$669.00	<a href="#">Spec Sheet</a> ▶ <a href="#">Buy Now</a> ▶ <a href="#">Limited Availability</a>
16973	6.5 Creedmoor	4	22"	Moss Green Synthetic	Flush-Fit	Matte Stainless	5/8"-24	Right-Handed	Sports South Distributor Exclusive	<a href="#">Spec Sheet</a> ▶ <a href="#">Buy Now</a> ▶ <a href="#">Limited Availability</a>
26987	350 Legend	5	16.38"	Black Synthetic	AR-Style	Flat Dark Earth Cerakote®	1/2"-28 x 0.4"	Right-Handed	Davidson's Distributor Exclusive	<a href="#">Spec Sheet</a> ▶ <a href="#">Buy Now</a> ▶ <a href="#">Limited Availability</a>
26991	350 Legend	5	20"	Black Synthetic	AR-Style	Stainless	1/2"-28 x 0.4"	Right-Handed	Davidson's Distributor Exclusive	<a href="#">Spec Sheet</a> ▶ <a href="#">Buy Now</a> ▶ <a href="#">Limited Availability</a>
36900	350 Legend	5	22"	Black Synthetic	AR-Style	Matte Black	1/2"-28 x 0.4"	Right-Handed	Lipse's Distributor Exclusive	<a href="#">Spec Sheet</a> ▶ <a href="#">Buy Now</a> ▶ <a href="#">Limited Availability</a>
36902	350 Legend	5	22"	Moss Green Synthetic	AR-Style	Matte Black	1/2"-28 x 0.4"	Right-Handed	Big Rock Sports Distributor Exclusive	<a href="#">Spec Sheet</a> ▶ <a href="#">Buy Now</a> ▶ <a href="#">Limited Availability</a>

INSTRUCTION MANUAL ? CUSTOMER SERVICE ! ACCESSORIES # SERIAL # LOOKUP





10/1/23, 8:52 AM

Ruger American® Rifle Predator

Ruger Marksman Adjustable™ trigger offers a crisp release with a pull weight that is user adjustable between 3 and 5 pounds, allowing shooters to make that perfect shot.



The one-piece, three-lug bolt with 70° throw provides ample scope clearance and utilizes a full diameter bolt body and dual cocking cams for smooth, easy cycling from the shoulder.



Outstanding accuracy helps make every hunt a success.

Ergonomic, lightweight synthetic stock designed for quick, easy handling blends a classic look with modern forend contouring and grip serrations.



Patented Power Bedding™, integral bedding block system positively locates the receiver and free-floats the barrel for outstanding accuracy.

Heavier tapered, threaded barrel with factory-installed thread protector is cold hammer-forged, resulting in ultra-precise rifling that provides exceptional accuracy and longevity.



Soft rubber buttpad is crafted for maximum recoil reduction.



Factory-installed, one-piece Picatinny scope base.



The visible, accessible and easy-to-actuate tang safety provides instant security.



Also includes: one magazine; sling swivel studs.

Features listed above are available on all standard models, but may not appear on Distributor Exclusive models. See individual spec sheets for model specific features.

01:54

Ruger American® Rifle 6mm Creedmoor  
TV Spot  
Larry Weishuhn TV Spot

AR/AI-Style Mag Well Disassembly  
Features  
Larry Weishuhn

AR/AI-Style Mag Well Reassembly  
Ruger American® Rifle Cheekpad  
Disassembly/Reassembly

**PRODUCT  
REGISTRATION**



**LOCKING  
DEVICE**



**NEW  
FIREARMS  
OWNER  
RESOURCES**



**TELL THE  
CEO**



S&W, Ruger & Co., Inc. is one of the nation's leading manufacturers of rugged, reliable firearms for the commercial sporting market. With products made in America, Ruger offers consumers almost 800 variations of more than 40 product lines, across both the Ruger and Marlin brands. For almost 75 years, S&W, Ruger & Co., Inc.

CONNECT WITH  
**RUGER**



INSTRUCTION MANUAL



CUSTOMER SERVICE



ACCESSORIES



SERIAL # LOOKUP



10/1/23, 8:52 AM

Ruger American® Rifle Predator

[CONTACT](#) | [PATENTS](#) | [PRIVACY POLICY](#) | [TERMS OF USE](#) | [SOCIAL MEDIA RULES](#)

[JOIN OUR EMAIL LIST](#) 

 **RUGGED, RELIABLE FIREARMS®**

Copyright © 2023 by Sturm, Ruger & Co., Inc.



 [INSTRUCTION MANUAL](#)

 [CUSTOMER SERVICE](#)

 [ACCESSORIES](#)

 [SERIAL # LOOKUP](#)

# Exhibit B-16



PDP - www.waltherarms.com

waltherarms.com/pdp



HOME PARTS ACCESSORIES JOURNAL CONTACT

ACCOUNT SEARCH



PDP

It's our duty to build the best performing firearm.  
**IT'S YOUR DUTY  
TO BE READY**



GUNS AND AMMO: "2021 HANDGUN OF THE YEAR!"



INDUSTRY CHOICE AWARDS: "2021 HANDGUN OF THE YEAR!"



Type here to search



USOIL -2.20% 1:10 PM 9/28/2023



**PDP COMPACT**

	Compact 4"
Item #	2851229
Magazine Capacity	7 Rounds
Magazines Included	2
Caliber	9mm
MSRP	\$699.00
10 Round Item #	2854686



**PDP FULL SIZE 4"**

	Full-Size 4"
Item #	2851237
Magazine Capacity	11 Rounds
Magazines Included	1
Caliber	9mm
MSRP	\$699.00
10 Round Item #	2854694



**PDP FULL SIZE 4.5"**

	Full-Size 4.5"
Item #	2842475
Magazine Capacity	8 Rounds
Magazines Included	2
Caliber	9mm
MSRP	\$699.00
10 Round Item #	2858126



### PDP COMPACT 5"



### PDP FULL-SIZE 5"



### PDP PRO SD COMPACT 4"



	Compact 5"
Item #	2844222
Magazine Capacity	15 Rounds
Magazines Included	2
Caliber	9mm
MSRP	\$699.00
10 Round Item #	2858151

	Full Size 5"
Item #	2844001
Magazine Capacity	18 Rounds
Magazines Included	2
Caliber	9mm
MSRP	\$699.00
10 Round Item #	2858134

	PDP PRO SD COMPACT 4"
Item #	2844176
Magazine Capacity	18 Rounds
Magazines Included	3
Caliber	9mm
MSRP	\$849.00
10 Round Item #	2854686



## WALTHER PDP FULL SIZE MAG 9MM 10RD DIMPLED

Walther PDP Full-Size Magazine  
10 Rounds  
9mm Luger  
Dimpled

Model: PDP-FS-10RD-D

ADD TO CART



# Exhibit C

**IN THE UNITED STATES DISTRICT COURT  
FOR THE SOUTHERN DISTRICT OF ILLINOIS**

<p>CALEB BARNETT, <i>et al.</i>, Plaintiffs, vs. KWAME RAOUL, <i>et al.</i>, Defendants.</p>	<p>Case No. 3:23-cv-209-SPM ** designated Lead Case</p>
<p>DANE HARREL, <i>et al.</i>, Plaintiffs, vs. KWAME RAOUL, <i>et al.</i>, Defendants.</p>	<p>Case No. 3:23-cv-141-SPM</p>
<p>JEREMY W. LANGLEY, <i>et al.</i>, Plaintiffs, vs. BRENDAN KELLY, <i>et al.</i>, Defendants.</p>	<p>Case No. 3:23-cv-192-SPM</p>
<p>FEDERAL FIREARMS LICENSEES OF ILLINOIS, <i>et al.</i>, Plaintiffs, vs. JAY ROBERT "JB" PRITZKER, <i>et al.</i>, Defendants.</p>	<p>Case No. 3:23-cv-215-SPM</p>

**SECOND SUPPLEMENTAL DECLARATION OF  
JAMES E. YURGEALITIS**



**SECOND SUPPLEMENTAL DECLARATION OF  
JAMES E. YURGEALITIS**

I, James E. Yurgealitis, declare as follows:

1. I am submitting this declaration to further supplement and clarify my June 16, 2023 supplemental declaration (ECF 116-1, “June Declaration”).

2. I specifically wish to address the assertions made by Matthew Wilson, a plaintiff in the *Langley* case, about paragraph 8 of my June Declaration in Mr. Wilson’s June 27, 2023 affidavit (ECF 117-1, “Wilson Affidavit”). In paragraph 8 of my June Declaration, I listed fifteen handgun models or series “from well-established manufacturers that feature 15-rounds magazines that are not interchangeable with any rifles or other long guns[.]” June Declaration ¶ 8. In paragraph 6 of the Wilson Affidavit, Mr. Wilson claims that my statements in paragraph 8 of my June Declaration are “largely false[.]” Wilson Affidavit ¶ 6.

3. I respectfully disagree with Mr. Wilson in several instances regarding his characterization of which handgun models use magazines that are “interchangeable” with rifles or other long guns. Much of my disagreement with him comes from at least two main differences in how we assess what is “interchangeable”.

4. First, I do not believe magazines that require physical modification in order to fit and function in another firearm type are “interchangeable.” Nor do I believe that the addition of parts or accessories to a rifle in order for it to accept magazines not originally intended and / or supplied for and / or with that rifle renders magazines “interchangeable.”

5. Second, I do not believe that whether out-of-production rifles and other long guns might have been able to accept a particular magazine matters to the average person looking to purchase a magazine today.

**Mr. Wilson's Examples Requiring Physical Modification**

6. Mr. Wilson identifies at least three handguns from my list using magazines that would require physical modification in order to be “interchangeable”: the CZ Model 75, the CZ Shadow, and the Springfield Armory XD Series.

7. Regarding the CZ Model 75 and Shadow series, Mr. Wilson claims that these handguns “use the same magazine, and the magazines are also used in the Kel Tec Sub 2000 Gen 2 rifles.” Wilson Affidavit ¶ 6(a). Mr. Wilson’s affidavit then cites to four attached exhibits, the first two of which, Exhibits A and B, are “mag catch kits” available for sale that enable the modification of the Kel-Tec Sub 2000 Gen 2 rifle to accept Model 75 and Shadow magazines. Wilson Affidavit, Exhibits A & B. These “mag catch kits” include parts used to physically modify the rifle to accept magazines originally designed for the Model 75 and Shadow. In my professional opinion, installing additional parts or accessories (or performing some other physical modification) to a rifle in order to utilize magazines from another weapons platform does not automatically render those magazines “interchangeable.”

8. Mr. Wilson also says in his affidavit that magazines for the Springfield Armory XD Series “are largely interchangeable with the Beretta M92 Series, except that one needs to cut a single notch in the XD magazines to make them work in the M92, or a single notch in a M92 Beretta magazine to make them work in an XD.” Wilson Affidavit ¶ 6(d). Once again, in my professional opinion, a magazine that requires physical modification in order to be used in another firearm is not “interchangeable” with that other firearm.

**Mr. Wilson's References to Out-of-Production Firearms**

9. Mr. Wilson also identifies various out-of-production firearms that he says are capable of accepting magazines from the handguns I identified in paragraph 8 of my June Declaration. My focus in preparing my June Declaration was on interchangeability with rifles that are still in production and being imported for sale at licensed firearms dealers now, in 2023.

10. My understanding of the *Langley* plaintiffs' concerns about the difference between the 15-round and 10-round magazine threshold in Public Act 102-1116 was that average people looking to acquire magazines for their firearms might not be able to determine what they can legally purchase in Illinois.

11. Based on this understanding, my focus in my June Declaration was on looking at the current retail market for firearms and magazines in Illinois. I do not believe an average person looking to buy a handgun or 15-round handgun magazine now would care whether the firearm's magazine could have been used in a rifle that has been out of production since the 1980s or 1990s.

12. For example, Mr. Wilson references the Tanfoglio TZ 75, which he acknowledges was "formerly imported by FIE in Florida in the 1980s," and the AR-24 Pistol, which he likewise acknowledges was "formerly imported by Armalite[.]" Wilson Affidavit 6(a). Both of these handguns are a derivation or copy of the Czech CZ-75 (still being produced in different variants) however the TZ 75 and AR-24 pistols have been out of production over a decade. As a result, I do not believe it will matter to the average person going into a firearm retailer in Illinois today how many rounds the magazines for these firearms could hold, and whether those magazines are interchangeable in a rifle or other long gun.

13. Similarly, Mr. Wilson notes that the Smith & Wesson 5900 series, although discontinued, "uses the same magazine as the also discontinu[e]d Marlin Camp rifle, in 9mm," and that "Marlin camp rifles used to be sold a[t] most Wal-Marts." Wilson Affidavit ¶ 6(b). Mr. Wilson

then cites a Wikipedia article as the basis for his claim that the Marlin Camp rifle can accept the same magazine as a Smith & Wesson 5900 handgun.

14. In my experience, a professional firearms expert would not rely exclusively on a Wikipedia article to determine whether a magazine could be used in a particular firearm. Without knowing more about the manufacturer's specifications for the particular Marlin Camp Rifle model that Mr. Wilson is referencing, I cannot definitively say whether he is correct that a Smith & Wesson 5900 handgun magazine is "interchangeable" (meaning fully operable and absent any modification) without encountering problems (jamming or other failure to properly feed ammunition) in a Marlin Camp Rifle. Nor can I state with any degree of certainty that the Wikipedia article Mr. Wilson references is authoritative or even correct. The rifle has been out of production for nearly a quarter of a century as Marlin ceased production in 1999.

15. Mr. Wilson also said in his affidavit that Ruger P85 and P89 pistols "use the same magazine as the Ruger PC9 rifle." Wilson Affidavit ¶ 6(c).

16. Mr. Wilson's statement about what magazines function in a Ruger PC9 also struck me as inconsistent with my knowledge of that particular rifle. After reviewing Mr. Wilson's affidavit, I contacted Ruger to ask whether magazines for the P85 and P89 pistols can be used in a PC9 rifle. I was informed by Ruger's customer service department that P85 magazines are not interchangeable with the PC9 rifle. I was also informed that P89 magazines (from pistols in a certain serial number range) were interchangeable with some PC9 rifles manufactured in 2003 or earlier, but not later models.

17. Based on this production history, I wish to qualify my prior statement in paragraph 8 of my June Declaration regarding the P89 to acknowledge that some P89 magazines are interchangeable with PC9 rifles manufactured prior to 2004. Neither firearm is currently in production today as Ruger ceased production of the P89 in 2007 and the PC9 rifle in 2006.



18. I reserve the right to amend, supplement, or correct this declaration, as well as my prior declarations, including my February Declaration and my June Declaration, in these consolidated actions.

\* \* \*

Pursuant to 28 U.S.C. § 1746, I declare under penalty of perjury that the foregoing is true and correct.

Executed on: 10/09/2023

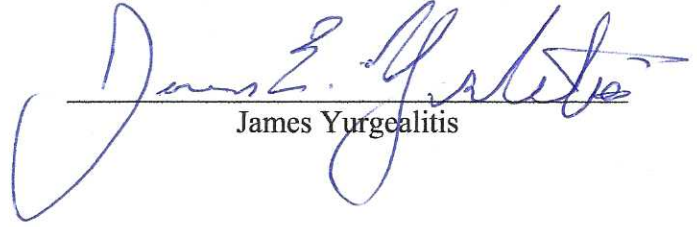
  
James Yurgealitis