

**IN THE UNITED STATES DISTRICT COURT  
FOR THE SOUTHERN DISTRICT OF ILLINOIS**

CALEB BARNETT, et al.,	)	Case No. 3:23-cv-209-SPM
Plaintiffs,	)	**designated Lead Case
	)	
v.	)	
	)	
KWAME RAOUL, et al.,	)	
Defendants,	)	
	)	
<hr/>	)	
DANE HARREL, et al.,	)	Case No. 3:23-cv-141-SPM
Plaintiffs,	)	
	)	
v.	)	
	)	
KWAME RAOUL, et al.,	)	
Defendants,	)	
	)	
<hr/>	)	
JEREMY W. LANGLEY, et al.,	)	Case No. 3:23-cv-192-SPM
Plaintiffs,	)	
	)	
v.	)	
	)	
BRENDAN KELLY, et al.,	)	
Defendants,	)	
	)	
<hr/>	)	
FEDERAL FIREARMS LICENSEES OF ILLINOIS, et al.,	)	Case No. 3:23-cv-215-SPM
Plaintiffs,	)	
	)	
v.	)	
	)	
JAY ROBERT "J.B." PRITZKER, et al.,	)	
Defendants.	)	
<hr/>	)	

**DECLARATION OF JEFFREY EBY**

I, Jeffrey Eby, declare as follows:

1. I am at least 18 years old and have personal knowledge of the statements contained in this Declaration.

2. The statements contained in my expert report that I co-authored in this case, dated May 10, 2024, and attached hereto as **Exhibit 1**, including any clarifications provided during my subsequent deposition, are true and accurate.

3. The statements contained in my expert rebuttal report that I authored in this case, dated June 10, 2024, and attached hereto as **Exhibit 2**, including any clarifications provided during my subsequent deposition, are true and accurate.

4. If called to testify at trial in this case, I would testify to the matters set forth in my expert report and elaborated on in my sworn deposition testimony provided in the above-captioned cases. My testimony would be consistent with all of the statements in the report and deposition (and any errata sheet), which included a complete statement of all opinions expressed, the basis and reasons for such opinions, the facts and data considered by me in forming said opinions, discussion about and identification of my qualifications as an expert witness (including any publication I may have authored in the previous 10 years and any cases during the previous 4 years where I may have testified as an expert at trial or by deposition), and a statement of compensation paid to me for study and testimony in this matter.

I declare under penalty of perjury that the foregoing is true and correct.

Executed on September 13, 2024 within the United States.

*s/ Jeffrey Eby* \_\_\_\_\_  
Jeffrey Eby  
Declarant

# **EXHIBIT 1**

**JOINT REPORT OF EXPERT WITNESSES**  
**JEFFREY EBY AND MICHAEL MUSSELMAN**

**BACKGROUND/QUALIFICATIONS**

**Jeffrey Eby**

I, Jeffrey Eby, served in the United States Marine Corps from June of 1982 through November of 2010. I spent 17 years as an enlisted infantry Marine before receiving a Commission to Chief Warrant Officer-2 in February 1999. I retired as a Chief Warrant Officer-5, as the senior infantry weapons officer in the Marine Corps, serving under the Deputy Commandant for Plans Policies and Operations inside the Pentagon in November 2010. As an Infantry Weapons Officer, I served as an expert advisor at the Infantry Battalion level (900 Marines), Infantry Regimental Combat Team (10,000 Marines), as well as the advisor to the Deputy Commandant of Plans, Policies & Operations as the Infantry Advocate for all manning, training, and equipping efforts in support of the Marine Corps (175,000 Marines). During this time, I served in 4 combat deployments to Iraq for a total of 27 months. I was one of 44 infantry weapons officers among 175,000 Marines when I was commissioned in 1999, retiring as one of the 101 infantry weapons officers among 175,000 marines in November 2010. The growth of the infantry weapons officer program escalated in 2003 from 44 to 101 as operations Iraqi freedom and Enduring Freedom in Iraq and Afghanistan continued.

Marine Corps Infantry Weapons Officers, titled Marine Gunners, are considered the USMC's experts on small arms within ground combat. The job of the Marine Gunner is to train Marines on the care, cleaning, and employment of all individual and crew served weapons (2 rifles<sup>1</sup>, 3 sniper rifles, 2 grenade launchers, 4 different machine guns, 2 mortar systems, 4 rocket systems, 2 anti-tank missile systems, a 25mm bushmaster cannon, tank main gun capabilities, artillery capabilities, all associated day and night aiming systems, laser pointers and illuminators, as well as all breaching techniques using ballistic, mechanical or explosive methods) within the ground combat forces. Marine Gunners are tasked to develop training programs for weapons, both individually and in combination of systems, and then to advise commanders on the best selection and employment of various weapons systems that will cause the most effective opposition for our enemies.

**Michael Musselman**

I, Michael Musselman, served in the United States Marine Corps from June of 1985 through July 1st of 2015, spending 18 years as an enlisted Marine serving in the infantry as a 81mm mortarman, Fire Direction Chief, Forward Observer, Platoon Sergeant, Battalion Master Gunner for the 25mm Bushmaster chain gun and coaxial medium machinegun, I received my Commission as Chief Warrant Officer 2, Marine Gunner in February of 2003. During which

---

<sup>1</sup> The US Army Weapon Systems Handbook 2020-2021 [Weapon Systems Handbook 2020-2021 \(army.mil\)](#) does not use terms such as “service, assault, nor battle” when defining the basic issued rifle in the hands of combat units. The simple term ‘rifle’ is sufficient, as indicated within this reference on pages 142, 144, 180, 208, 209, 320, 354, 372, 376, 382, 388, 390,

time, I studied ballistics while stationed at Quantico, Virginia, worked with numerous police departments on consulting with their firearm training personnel, to include Chicago PD, Illinois State Police, Naperville PD, Boston PD, New York PD, Virginia State Police, and several other agencies, started the Marine Corps Combat shooting team, to focus on different methods of weapon handling and target engagement. I retired as a Chief Warrant Officer 5 Marine Gunner for the 1<sup>st</sup> Marine Division at Camp Pendleton, California responsible for the overall tactics and policies regarding all small unit weapons systems for 24,000 Marines within the first Marine Division as well as the first Marine Expeditionary Force, I planned and executed six division level live fire exercises, which incorporated several different weapon systems to include, M4, M16A4, 60mm and 81mm mortars, M249 light machinegun, M240 Medium machinegun, M2 .50 cal Heavy machinegun, all anti-tank missiles and rockets, demolitions and explosives, 155mm Artillery, M1A2 Main Battle Tank, all aircraft both fixed wing and rotary wing rockets and bombs all within close proximity of Marines conducting ground maneuvers. I made five combat deployments to Iraq and Afghanistan which my role was ensuring the Marines were using the most effective use of weapon and targeting systems to engage enemy combatants with direct fire and indirect fire, and also trying to determine the cause of injuries inflicted by the enemy on US service members in order to develop better training and tactics. I personally rewrote the entire manual on 25mm Bushmaster Chain gun Gunnery and qualifications. I served on several Marine Corps rewrite teams changing infantry doctrine, tactics and procedures concerning small, medium and large caliber weapon systems.

## **OPINIONS**

It is our understanding that Illinois restricts as “assault weapons” any:

- A. semiautomatic rifles that accept detachable magazines and have one or more of the following features:
  - i. a pistol grip or thumbhole stock;
  - ii. a protruding grip that can be held by the non-trigger hand;
  - iii. an adjustable, folding, thumbhole, or detachable stock;
  - iv. a flash suppressor; and
  - v. a shroud attached to the barrel or that partially or completely encircles the barrel, allowing the bearer to hold the firearm with the non-trigger hand without being burned, but excluding a slide that encloses the barrel.
- B. Semiautomatic rifles that have a fixed magazine with the capacity to accept more than 10 rounds.
- C. semiautomatic pistols that accept detachable magazines and have one, multiple, or all of the following features:
  - i. a threaded barrel;
  - ii. a second pistol grip or another feature capable of functioning as a protruding grip that can be held by the non-trigger hand;
  - iii. a shroud attached to the barrel or that partially or completely encircles the barrel, allowing the bearer to hold the firearm with the non-trigger hand without being burned, but excluding a slide that encloses the barrel;

- iv. a flash suppressor;
  - v. the capacity to accept a detachable magazine at some location outside of the pistol grip; and
  - vi. a buffer tube, arm brace, or other part that protrudes horizontally behind the pistol grip and is designed or redesigned to allow or facilitate a firearm to be fired from the shoulder.
- D. Semiautomatic pistols that have a fixed magazine with the capacity to accept more than 15 rounds.
- E. semiautomatic shotguns that have any one of the following features:
- i. a pistol grip;
  - ii. a fixed magazine with the capacity of more than 5 rounds; or
  - iii. the capacity to accept a detachable magazine.

Based on the weapons expertise we have acquired and that was expected of our specific rank in our service to the USMC, and the supporting documentation cited herein, we will opine on the capabilities that are expected of weaponry used in military combat and how virtually none of the firearms that Illinois has restricted falling into the above-described categories are even used by militaries, let alone meet those standards that the military demands. Specifically, in sum:

1. Beyond certain semi-automatic-only .50 caliber special application rifles and the M14 which has been converted to a M39 Enhanced Marksman Rifle (EMR), we are unaware of a single military in the world, let alone any branch of the U.S. military, that uses any semiautomatic-only rifles for general combat purposes.
2. We are unaware of a single military in the world, let alone any branch of the U.S. military, that uses pistols that meet the above description. The pistols that are used by military personnel do not serve any combat purpose; rather they are a last-line of self-defense for certain limited personnel.
3. While the military does employ shotguns, including semiautomatic ones that have a pistol grip and a fixed magazine with the capacity of more than 5 rounds (We are unaware of any shotgun used by the military that has the capacity to accept a detachable magazine), shotguns have no significant combat tasks to perform.
4. It is our understanding that, in defining “assault weapon” for rifles/handguns, Illinois does not distinguish between those that use centerfire ammunition and those that use rimfire ammunition. In other words, rifles/handguns that use rimfire ammunition can be “assault weapons” under Illinois law. Firearms using rimfire ammunition, regardless of their configuration, are not used in the military for any purpose, let alone combat. Rimfire ammunition generally comes nowhere near the power desired of ammunition used in combat. We are unaware of any rimfire ammunition ever used by any military, in the U.S. or otherwise; at least not in the 20th or 21st centuries.

## **RIFLES**

The last general purpose issued semi-automatic only rifle for U.S. forces was the M1 Garand, which ceased service in 1957 when it was replaced by the select fire<sup>2</sup> M14 rifle with a 10-20 round detachable box magazines. In 1962, the M14 was replaced with the M16 series rifles, which are still in use today. In sum, no common service rifles have been semi-automatic only since 1957, which was the last time the US fought against a peer opponent.<sup>3</sup>

Following combat against the Chinese army in Korea in 1950, the military services realized that a higher volume of rifle fire was necessary against 'peer' opponents than what could be achieved from the slow firing, slow to reload, and difficult to manage recoil of the M1 Garand chambered in the larger .30-06 cartridge, or the older bolt action M1903 Springfield rifles in common use throughout the military.

Fighting against a peer opponent requires a choreographed response during an engagement. The infantry usually meets the opponent by receiving gunfire from an entrenched or hidden force (historically we in the USA are the 'moving' force, attacking a prepared 'defending' force). The infantry rifleman requires a high volume of accurate fire to 'suppress'<sup>4</sup> an opponent into position. Think of suppression as an action that prevents the enemy from rising out of prepared positions to shoot at US forces. Sufficient suppression prevents enemy action and is measured by overwhelming the enemy's ability to return fire for the duration of friendly force firing. These are not precision aimed fires, as it is very unlikely that an enemy is visible to the approaching US forces as you would see in historical photos of the Civil War or World War I. These are not long duration fires either, as the attack develops and is executed rapidly, generally taking less than 2-3 minutes overall.

The riflemen need an extremely high volume of sufficiently accurate shots that will allow time for the 3-man machine-gun teams to be moved forward to the point of contact, mount their weapons onto tripods to support the engagement, locate the target areas, select an engagement criterion<sup>5</sup>, initiate firing shots and to refine their impact areas (of bullets) sufficient to continue suppressing the enemy. The machineguns suppressing the enemy positions allow the rifleman to slow down their rate of fire, preserving ammunition, cooling down the weapons, allowing leaders

---

<sup>2</sup> A selector lever on the common general purpose rifle has three settings: Safe, Semi-Automatic, or Full-Automatic

<sup>3</sup> See **Exhibit 1**, FM 3-0 Operations, 01 October 2022, page x, defines a peer opponent as an adversary that contests the joint force in all domains through several methods: Information warfare, Preclusion, Isolation, Sanctuary and Systems warfare. [FM 3-0 WEB Working.pdf \(army.mil\)](#)

<sup>4</sup> Field Manual 3-34.2, Combined-Arms Breaching Operations: "Suppression is a tactical task used to employ direct or indirect fires on enemy personnel, weapons, or equipment to prevent or degrade enemy fires and observation of friendly forces."

<sup>5</sup> Engagement criteria of Machineguns relate to fires in respect to ground (plunging, grazing), target (frontal, flanking, enfilade) or gun (fixed at one target point, searching near to far, traversing left to right)

to determine the next available actions (call in mortars or artillery, send in tanks or armored vehicles, call in air delivered strikes, or even to start disengaging if the contact conditions are not favorable to friendly forces).

Many studies were conducted by the US Army during the 1950s and 1960s to determine if semi-automatic firing rifles were sufficient for future ground combat. One study evaluated “flechette” rounds versus single projectiles per trigger pull, determining that flechette rounds had a higher casualty rate compared to single shots.<sup>6</sup> Another study evaluated a mix of weaponry from smaller 5.56mm projectiles to heavier 7.62mm projectiles, determining squads armed with low impulse 5.56mm weapons were superior to squads armed with 7.62 weapons in target effects, sustainability of effects, and overall effectiveness<sup>7</sup>. In all instances, automatic fire for short durations (2 min or less) against multiple targets provided significant increased hit probability vs semi-automatic fire. The end result of these and similar studies was the elimination of semi-automatic only rifles in consideration for future military service rifles.

By the early 1960’s, the US Military had moved to select-fire M16 variant weapons because of the two decades of studies and experiments. The initial M16 rifle had three selection settings available: safe, semiautomatic and fully-automatic. The M16A2 variant was modified to provide a ‘burst of three rounds’ setting instead of fully automatic to save ammunition, increase hits on target, and prevent the weapon from overheating while firing fully automatic. The training programs in the 1960s were not well developed to support the difficult action of shooting fully automatic, which was made more difficult by the much higher recoil of the heavier bullets in use before the M16 series weapons came along. The cartridge that the U.S. military uses in all its M16s, as do all NATO countries today, the 5.56x45mm NATO, is considered among, if not *the* weakest of all centerfire rifle cartridges. Using it relatively mitigates the punishing recoil of full auto fire with larger calibers, which improves accuracy of suppressive fire at a target area.

The methodical warfare practices from the Civil War until after Vietnam had US forces executing a type of defensive warfare up until the mid-1980s, in which infantry moved from one defensive position to the next, dug fighting-holes and awaited an enemy attack (WWII was fought like this by most Infantry across the Pacific Island-hopping campaign and in Europe). In the 1980s, all U.S. ground forces changed to Maneuver Warfare, which had much less use of fighting-holes and saw US Forces in the offensive predominantly. Automatic, unaimed fire to suppress enemies’ defensive position became the normal engagement behavior during training against the more dangerous peer level threats.

---

<sup>6</sup> Project Salvo I, conducted by the US Army Operations Research Office, published in 1959 conducted experimentation using multi-dart “flechette” type projectiles, automatic fire vs semi-automatic fires with a measurement of increased/decreased casualties metrics against cardboard targets. Automatic fires provided a 60% increase of casualties over single rounds fired. Smaller, lighter weapons provided a 50% increase effectiveness against the M1 Garand used as a baseline.

<sup>7</sup> Small Arms Weapons Systems (SAWS) conducted by the US Army Combat Developments Command Experimentation Command at Fort Ord, CA, published in May 1966. See **Exhibit 2**.



The only reason that U.S. Forces have employed semi-automatic rifle fire during the last 60 years of combat is due to our fighting non-peer enemies over this duration (Low Intensity combat in Iraq, Afghanistan, criminal behavior in Panama, or Police Actions in Vietnam). Semi-auto fire engagements made sense in those situations where we were not facing well trained, well-armed opponents, but instead outnumbered our opponents at the point of contact, and the opponents lacked training, equipment, aerial support, or reinforcements, making fully-automatic fire unnecessary.

Against a peer threat, which all US Forces prepare for every day, fully automatic fire is critical. It is rehearsed repeatedly. The U.S. Forces do not prepare for future fights against non-peer threats, therefore will always be ready to use fully automatic fire against determined peer level threats in all environments. All US Forces are prepared to engage against a peer threat, at which point, the constant training exercises have focused on providing sufficient accurate suppression with full auto firing selection from service rifles. At the time of this writing, the USMC has issued the M27 rifle to all infantryman, which comes with a safe, semiautomatic, and fully automatic settings (but not burst-fire). The US Army has just authorized a product improvement to the M4 series rifle to revert back to fully automatic fire in lieu of burst-fire. The US Army will issue the XM7 rifle with select fire settings of safe, semi, and fully automatic to those front-line units that will not receive the M4 PIP (product improvement program). These changes are a recognition of the value of fully-automatic fire in preparation for future peer-level conflicts.

This has been confirmed by testing. A study by the US Army Operations Research Office on Operational Requirements for an Infantry Hand Weapon provides: “...*Recent ORO investigations in Korea have shed some light on this subject by indicating quantitatively the comparative importance of aimed and unaimed fire as related to offensive and defensive operations. Generally, aimed fire plays a more important part in defense than unaimed or volume fire, whereas in the offensive, the reverse is true....*”<sup>8</sup>

None of the weapons banned by Illinois are remotely sufficient to handle the military’s requirements for weapons it uses against peer level countries, as they lack the necessary volume of fire (burst or automatic fire) to suppress an enemy long enough to bring other heavier weapons/assets to bear upon the enemy.

## **PISTOLS**

No general-purpose force in the U.S. Army or Marine Corps has a tactical task against an enemy that requires a pistol as the solution. Pistols are supplied to soldiers/Marines who man crew-served weapons (mortars, machineguns, rockets, missiles) so they may have a personal protection weapon available should their primary weapon become inoperable. Pistols are issued to Staff Non-Commissioned Officers (enlisted ranks of E-6 and above), and to Officers (O-2 and

---

<sup>8</sup> [Operational-Requirements-For-An-Infantry-Hand-Weapon.pdf](#), Technical Memorandum ORO-T-160 Operational Requirements for an Infantry Hand Weapon by Norman A. Hitchman, entered into the Library Army War College, Carlisle Barracks, PA on 19 June 1952 with the Operations Research Office conducted by the 10 of 111 (pdf). Originally classified “Secret” but now declassified. Pages 5-6. See **Exhibit 3**.

above normally) as these personnel have the primary task of leadership and management of forces, not directly engaging the enemy. Pistols lack sufficient velocity to ensure bullet penetration and expansion required to stop an attacker in a military context, where assailants are often wearing body armor or are far away before the attacker can cause harm.

### **SHOTGUNS**

In the rare instances that they are used in theater, shotguns are generally limited to use by special operations forces for ballistic breaching methods of shooting off hinges or doorknobs for urban entry (like a civilian SWAT team uses a battering ram). Military Police use shotguns (generally pump-action) for guard duty or riot control purposes. Front-line combat forces, however, have limited use for any shotguns outside of police actions. General purpose forces tend not to see the value in using the shotguns available to them, due to shotguns' slow reload time, limited range, and bulky ammunition requirements, not making them worth carrying into combat.

### **MAGAZINES**

It is our understanding that Illinois restricts as “large capacity ammunition feeding devices” any device that is readily detachable from the firearm that delivers ammunition into a firearm that has a capacity of, or that can be readily restored or converted to accept, more than 10 rounds of ammunition for long guns and more than 15 rounds of ammunition for handguns. While it is true that, with few exceptions such as sniper rifles, the military *exclusively* uses “large capacity ammunition feeding devices” as Illinois defines them, Illinois’s definition includes magazines with capacities significantly lower than anything the military would use.

- A. Virtually all box magazines for M16/M4 rifles in the military use 30-round magazines. In rare instances, 20-round magazines will be used for select personnel performing specific, limited functions. We have never seen a magazine for M16/M4 rifles in the military that had a capacity of less than 20-rounds (and even those were rare). What’s more, the only reason box magazines for M16/M4 rifles are generally 30-rounds, but not more, is only because decades of testing showed that magazines over that capacity were not sufficiently reliable to bet our lives on because they were too susceptible to feeding issues, due to losing spring tension (i.e., jamming). But for that limitation, the military would use much larger box magazines for M16/M4 rifles; proof of which is the decades it spent trying to do so with testing.
- B. The U.S. military has adopted the Sig Sauer M17 as the pistol it issues to those select servicemembers who carry pistols. All box magazines for the Sig Sauer M17 pistol issued in the military have a capacity of either 17-rounds or 21-rounds. Those are the same capacity magazines that come standard with the Sig Sauer M17 pistol when sold to the general public (except in jurisdictions that have magazine capacity restrictions). That is not surprising since, as explained above, pistols in the military are used for the same purpose they are in civilian life: self-defense.

- C. As explained above, it is our understanding that Illinois deems semiautomatic rifles that have a fixed magazine with the capacity to accept more than 10 rounds and semiautomatic pistols that have a fixed magazine with the capacity to accept more than 15 rounds to be “assault weapons.” We are unaware of any semiautomatic rifle or pistol that the U.S. military, or any military in the world, uses that uses fixed magazines of any capacity.

### **AMMUNITION**

The military has access to a variety of bullet designs that allow bullets to be selected to meet mission requirements. Bullets designed for the low impulse, buffered 5.56 x 45mm rifles of the M16 series, M4 series and M27 series rifles that are currently available are:

- a. M855A1 Enhanced Performance Round: Considered the first environmentally friendly round as it is lead free. This bullet design has demonstrated more consistent performance in both soft and hard targets and increased accuracy beyond 300 meters. This bullet is now the primary bullet for US forces in combat.
- b. M855: A 62 grain bullet designed with a steel penetrator to be used against body armor of combatants in the 1980’s. Research by the US Army in the early 2000’s identified this bullet to be ‘yaw dependent’ as well as speed dependent (at least 2500 feet per second) to have sufficient lethality upon the target. This shortfall led to the M855A1 Enhanced Performance Round listed above.
- c. M193: A 55 grain bullet, lead core bullet without the steel penetrator designed inherent to the M855A1 or M855 bullets. This bullet was the primary bullet in use during the Vietnam War from the early 1960s until replaced as the primary service cartridge in the early 1980s.
- d. M856: A 63.7 grain tracer cartridge to assist marking targets, identifying where shots are landing at extended ranges, and to assist with night firing prior to the issuance of night vision equipment commonly in place today.
- e. M1037 Short Range Training Ammunition. Referred to as ‘frangible’ ammunition created from a frangible copper-filled polymer designed to lower ricochet beyond the target, or ricochet back towards the shooter. Usually used for ranges less than 100 meters when sensitive equipment or personnel are in the area.
- f. Mk262 Mod 1: A 77 grain Open Tip Match ammunition used as an interim cartridge in the mid 2005-2012 time frame when M855 was determined insufficient against combat opponents (over penetration, under expansion) and until M855A1 was finalized in design and in full volume production.
- g. M995. A 52 grain bullet with a tungsten carbide core for penetration of hard targets. Capable of penetrating 12mm (1/2”) of rolled homogenous armor at 100 meters and light body armor at normal combat distances.

The military does not choose these bullets with self-defense in mind, but with what will best accomplish the military mission at hand. That calculus does not necessarily consider effectiveness against non-combatants who lack body armor or who are within close proximity,

nor, in certain battlefield scenarios, concerns of bullets' over-penetration beyond the target, like a homeowner might be concerned about his neighbor.

### **RATE OF FIRE**

It is our understanding that the Seventh Circuit Court of Appeals indicated in its opinion for this case that the "rate of fire" of the semiautomatic rifles, handguns, and shotguns that Illinois has deemed "assault weapons" could be relevant to the legal analysis of whether they are different in kind from the M16 fully automatic rifle. First, we note that there is no official standard for measuring "rate of fire." In fact, there really is no such thing as a measurable "rate of fire" because there are so many variables that affect the pace at which a firearm can discharge projectiles (assuming that is what "rate of fire" refers to here).

One could conceivably measure the "cyclic rate" of fire for a particular firearm, which is the maximum rate of fire based solely on mechanical function. Essentially, it's the theoretical maximum rate of fire achievable by the weapon without any external factors affecting its operation, such as fatigue of the shooter, degradation of the barrel due to heat, wear, or ammunition/magazine limitations. This term "cyclic rate" was first used to measure belt-fed machineguns' potential volume of fire for suppressing enemy forces. It is generally understood that a fully automatic rifle, such as the USMC's M27 Infantry Automatic Rifle, can mechanically fire between 700-900 rounds<sup>9</sup> per minute depending on the age and condition of the rifle, as well as other physical factors.

Determining the cyclic rate for a semiautomatic rifle of any type, on the other hand, is essentially an unachievable myth that is more focused on marketing than reality. That is because, unlike a fully automatic rifle where the trigger can just be depressed once and rounds will discharge at a set, uniform pace (mechanically-speaking), semiautomatic fire is influenced by the particular user of the weapon: i.e., how fast the person can function the trigger; resistance to fatigue; management of recoil; etc. Various factors with the rifle itself can also affect how fast rounds are discharged, including barrel length, whether direct impingement or a gas piston, buffer weight, spring tension, powder load of ammunition, weight of bolt carrier.

There are also practical limitations that cyclic rate does not contemplate, such as damage to the firearm from heat buildup and ammunition availability or time for magazine changes. Discharging rounds at a rate of 700-900 rounds per minute would likely destroy the barrel before the minute is up. Setting that aside, military personnel are trained to reload a magazine in 1.5 seconds; so to achieve that rate of fire would require 24-30 magazine changes in under one second each, as well as having 24-30 magazines loaded and readily available for quick reloads. Our experience as NRA trained marksmanship instructors with civilian students gives us an expectation of the average civilian managing a 4-5 second reload time, and this while under no life threatening event that would initiate the Body Alarm Response. *The body's physiological responses to life and death situations often cause auditory exclusion* (temporary loss of hearing), *tunnel vision, loss of near, monocular, and night vision, loss of motor control* (such as pulling a

---

<sup>9</sup> See **Exhibit 4**, HK M27 IAR Product Sheet Sept 2012 page 3

trigger, reloading a magazine) and vasoconstriction <sup>10</sup>(leading to rapid heart rate). So the practical rate would be much less for them.

What’s more, there is the separate question of a practical rate of fire to maintain accuracy. Just because a firearm will fire at a certain rate does not make that rate particularly useful, as range increases accuracy diminishes along with the rate of sufficiently accurate fire. As explained above, automatic fire is not aimed fire for the purpose of hitting a specific target but rather is for suppressive fire to pin down the enemy where hits and near misses (within 2 meters) have an affect<sup>11</sup>. As range increases, the shooting position of the military moves from standing to more stable positions such as kneeling, squatting and prone. Along with the increased stability, rates of fire slow down from automatic fire to semi-automatic fire to keep the shots in a smaller area for purposes of suppression. So the practical rate of fire for an M16 is also much greater than the practical rate of fire for a semiautomatic firearm in a self-defense situation where there is a particular target or targets causing the threat.

In sum, there really is no way of reliably determining a “rate of fire” for semiautomatic firearms, in light of these variables. One thing is for certain, however, the rate of semiautomatic fire is significantly less than that of automatic fire. With semiautomatic fire, there is a significant delay in pulling the trigger through the breaking point, hitting the overtravel point, releasing and resetting the trigger and setting up for the next firing capability, compared to just pulling and holding the trigger of a fully automatic rifle. That is in addition to the variables with the specific user described above, e.g., potential for fatigue of the finger in repeatedly pulling the trigger, skill at staging additional magazines and getting the rifle reloaded, and recoil management. At the end of the day, the rate of automatic fire is obviously different in kind than semiautomatic fire; otherwise, the military would not insist on having automatic fire.

**Sustained rate of fire** - Using our experience as trainers, were we to estimate a starting expectation for untrained shooters to achieve a rate of fire with relative accuracy (50% hits on human size target), under no stress of life threatening events, shooting primarily firing from the standing position, firing semiautomatic fire with some reasonable degree of accuracy, we would start with these distances, rates and time frames, keeping careful notes for future refinement.

Distance	Rate of fire	time
7-10 yards	35-50 rpm	60 sec
15-25 yards	20-30 rpm	60 sec
50-80 yards	10-15 rpm	60 sec
100 - 150 yards	5-10 rpm	60 sec

<sup>10</sup> [Tactical Training & Physiological Response \(firstresponderswellnesscenter.com\)](https://www.firstresponderswellnesscenter.com)

<sup>11</sup> Small Arms Weapons Systems (SAWS) conducted by the US Army Combat Developments Command Experimentation Command at Fort Ord, CA, published in May 1966. Page 2-42, para (2) through Page 2-49. See **Exhibit 2**.

Other factors that must be applied to this are size of cartridge (the bigger the more recoil and impact on accurate rate of fire), a moving or stationary target, sighting system, (field of view), positioning, and availability of replacement magazines.

### **SELF-DEFENSE**

Based on our training and experience, it is our opinion that:

- A. The AR-platform rifle has been the most significant design in weaponry for common use among the public over the last 60 years. The lightweight, buffered design, with the proper bullet selection, is lethal enough to penetrate the 12” required to enter lethal areas, expand to create the most trauma necessary to stop the aggression of an attacker, has sufficient ammunition capacity to overcome the Body Alarm Response of inaccurate fire, poor shot placement, poor bullet behavior, multiple assailants trying to win the fight, etc., to better one’s chances of successfully ending the attack. We cannot emphasize the importance of the low recoiling 5.56 x 45mm cartridge, fired from the Armalite designed rifle with its internal buffering system for both combat and self defense purposes. The shortened barrel we recommend allows the rifle to maintain a lower weight when suppressed, yet still be portable enough to move within constricted spaces necessary in all military mobility platforms (rotary wing aircraft, ground vehicles, and urban structures).
- B. The best designed home defense weapon would be an 11.5” AR-platform short-barreled rifle with a suppressor, loaded with a 30-round magazine, a 1000 lumens flashlight on a side rail and an adjustable buttstock to allow the weapon to fit the clothing worn at the time it is needed. This highly portable, lightweight, low recoiling system, easy to point to the aggressor, would increase survivability of the victim immediately.
- C. The features on rifles that Illinois restricts (e.g., pistol grips, barrel shrouds, adjustable/removable stocks, and flash suppressors) do not serve any unique military purpose. As civilians now, we continue to train with firearms to be prepared for self-defense purposes and for recreation. The same rules of physics and shooting fundamentals apply whether the person using the firearm is in the military or not. Those features are to facilitate the comfortable and thus safe and effective use of the rifle, in *any* context. To say that semiautomatic-only rifles using ammunition designed for self-defense scenarios is the same as a select-fire M-16 using ammunition designed for combat, merely because they share external features designed to facilitate their safe, ergonomic, and effective use, would be like saying a street-legal, civilian Hummer is the same as a military High Mobility Multi-purpose Wheeled Vehicle (“HMMWV”), merely because they look similar and both have adjustable seats, headlights, and power-steering.

### **COMPENSATION**

Jeffrey Eby is being compensated at the rate of \$180.00 per hour.

Michael Musselman is being compensated at the rate of \$180.00 per hour.

Dated: May 10, 2024

*s/Jeffrey Eby*  
Jeffrey Eby

Dated: May 10, 2024

*s/ Michael Musselman*  
Michael Musselman

# **EXHIBIT 1**



Introduction

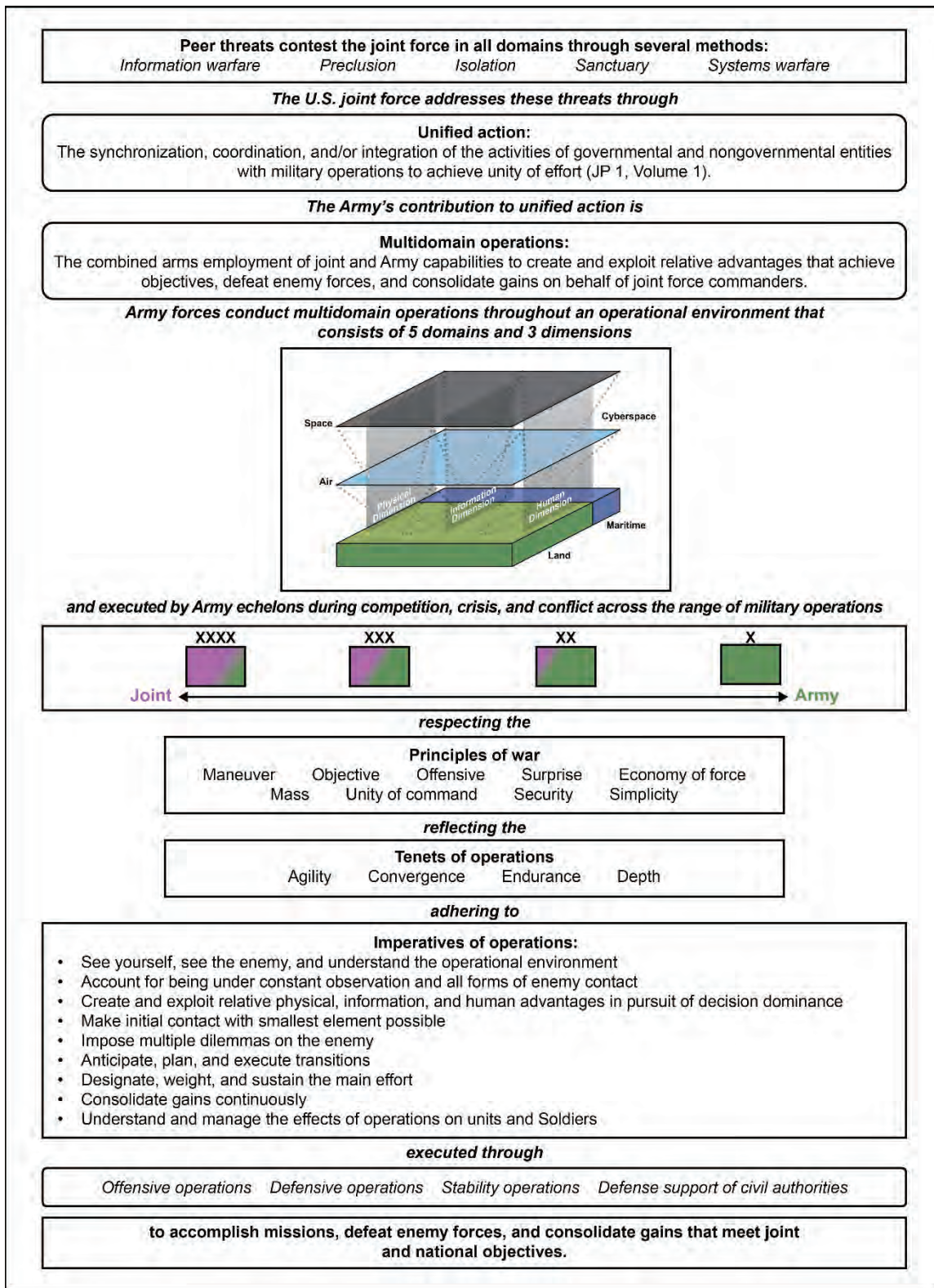

Introductory figure. FM 3-0 logic chart

FM 3-0 contains eight chapters and three appendixes:

# **EXHIBIT 2**

**UNCLASSIFIED** #17457



**AD NUMBER**

**AD-488 336**

**NEW LIMITATION CHANGE**

**TO**

**DISTRIBUTION STATEMENT - A**

Approved for Public Release; Distribution Unlimited.

**Limitation Code: 1**

**FROM**

**DISTRIBUTION STATEMENT - NONE**

No Prior DoD Distribution Security Control Statement Assigned.

**Limitation Code: NONE**

**AUTHORITY**

U.S. Army Operational Test and Evaluation Command, CSTE-IMZ, Alexandria, VA, via memo., dtd June 3, 1996 signed by Mr. Gary C. Miller, DCS/Info. Management.

**THIS PAGE IS UNCLASSIFIED**

FOR OFFICIAL USE ONLY

①  
PK

488336

AD No. \_\_\_\_\_  
DDC FILE COPY

# SMALL ARMS WEAPON SYSTEMS (SAWS).

PART ONE: MAIN TEXT.

SOURCE DATA  
SMALL ARMS  
WEAPONS SYSTEM  
STUDY  
MAY 96

- ① 10 May 66
- ② 272 p.

SEP 12 1966  
Abr



U. S. ARMY COMBAT DEVELOPMENTS COMMAND  
EXPERIMENTATION COMMAND FORT ORD, CALIFORNIA

Reproduced From  
Best Available Copy

PROTECTIVE MARKING OF THIS DOCUMENT WILL  
BE TERMINATED 3 YEARS AFTER ORIGINATION.

FOR OFFICIAL USE ONLY

COPY NO. \_\_\_\_\_

1037210

19991122107

THIS REPORT IS FOR INFORMATION ONLY. ACTION COPIES ARE SUBMITTED DIRECTLY TO COMMANDING GENERAL, US ARMY COMBAT DEVELOPMENTS COMMAND. THE VIEWS EXPRESSED IN THIS REPORT ARE THOSE OF THE COMMANDING GENERAL, US ARMY COMBAT DEVELOPMENTS COMMAND EXPERIMENTATION COMMAND AND ARE NOT NECESSARILY THOSE OF THE US ARMY COMBAT DEVELOPMENTS COMMAND OR THE DEPARTMENT OF THE ARMY.

**SMALL ARMS WEAPON SYSTEM (SAWS)  
FIELD EXPERIMENT**

**In Two Parts**

**PART ONE: MAIN TEXT**

**FOR OFFICIAL USE ONLY**

**HEADQUARTERS  
UNITED STATES ARMY COMBAT DEVELOPMENTS COMMAND  
EXPERIMENTATION COMMAND  
Fort Ord, California**

**SMALL ARMS WEAPON SYSTEMS (SAWS)  
FIELD EXPERIMENT**

~~(GDCEC 65-4)~~

10 May 1966

**APPROVED:**

*L. G. Cagwin*

**L. G. CAGWIN  
Major General, United States Army  
Commanding**

**FOR OFFICIAL USE ONLY**

**BLANK PAGE**



### AUTHORITY

1. Letter, CDCRE-E, HQ, USACDC, 23 February 1965, subject: US Army Combat Developments Command Experimentation Center Experiment - Small Arms Weapon Systems (SAWS)
2. Directive, US Army Combat Developments Command, 5 March 1965, subject: Army Small Arms Weapon Systems Program (SAWS)
3. Outline Plan USACDCEC Experiment 65-4, Small Arms Weapon Systems (SAWS) (U), July 1965
4. Letter, CDCRE-E, HQ, USACDC, 7 September 1965, subject: Outline Plan, Small Arms Weapon Systems (SAWS) Experiment

### CORRELATION

The Small Arms Weapon Systems (SAWS) Experiment is identified as USACDC Action Control No. M3523 and supports the following:

- |                         |   |
|-------------------------|---|
| a. Army Concept Program | Army 75   |
| b. Army Tasks           | 1: High Intensity Conflict<br>2: Mid Intensity Conflict<br>3: Low Intensity Conflict Type I<br>4: Low Intensity Conflict Type II<br>7: Complementing Allied Landpower |
| c. Phase                | Evaluation  |
| d. Functions            | Firepower   |

### CONTRACTUAL AGREEMENT

#### Scientific Support

Research Office, USACDCEC, Stanford Research Institute,  
Contract No. DA 04-200-AMC-1104(X).

#### **ACKNOWLEDGMENT**

**The United States Army Combat Developments  
Command Experimentation Command wishes to  
express appreciation to the United States Army  
Training Center, Infantry, Fort Ord, California,  
for its outstanding cooperation and support during  
the conduct of the SAWS experiment.**

CONTENTS

Part One: Main Text

ABSTRACT . . . . . xvi

SECTION I INTRODUCTION

A. Purpose . . . . . 1-1

B. Scope . . . . . 1-1

C. Objectives . . . . . 1-2

D. Phasing and Location . . . . . 1-3

E. Concept . . . . . 1-3

F. Conduct of the Experiment . . . . . 1-4

SECTION II EXPERIMENTAL DESIGN

A. General Characteristics of the Design . . . . . 2-1

B. Experimentation Materiel . . . . . 2-1

    1. Weapons and Ammunition . . . . . 2-2

    2. Organization of Materiel for Experimentation . . . . . 2-8

C. Instrumentation . . . . . 2-8

D. Experiment Personnel . . . . . 2-15

    1. Source of Support Personnel . . . . . 2-15

    2. Source of Experimentation Subjects . . . . . 2-15

    3. Organization of Experimentation Subjects . . . . . 2-15

    4. Training Program for Experimentation Subjects . . . . . 2-16

E. Experimentation Procedures . . . . . 2-22

    1. Uniform Operational Policies - General . . . . . 2-22

    2. Control and Balance of Weapon Mix Structure and Equipment . . . . . 2-22

    3. Modes of Fire . . . . . 2-23

    4. Control for Differences in Firer Location and Opportunity . . . . . 2-23

    5. Control of Squad Leader Variability . . . . . 2-23

    6. Control for Effects of Learning . . . . . 2-23

    7. Data Collection Procedures - Primary Measures . . . . . 2-24

    8. Administrative Procedures . . . . . 2-24

CONTENTS (Continued)

F. Experimentation Tactical Situations . . . . .	2-25
1. Situation 1: Rifle Squad in Line Assault . . . . .	2-27
2. Situation 2: Rifle Squad as a Base of Fire Supporting the Assault . . . . .	2-27
3. Situation 3: Machinegun Squad in Fire Support of the Assault . . . . .	2-30
4. Situation 4: Rifle Squad in Approach to Contact . . . . .	2-30
5. Situation 5: Rifle Squad as a Base of Fire Supporting the Advance . . . . .	2-30
6. Situation 6: Machinegun Squad in Fire Support of Advance . . . . .	2-35
7. Situation 7: Rifle Squad in Defense Against Attack . . . . .	2-35
8. Situation 8: Rifle Squad in Night Defense Against Attack . . . . .	2-38
9. Situation 9: Machinegun Squad in Defense Against Attack . . . . .	2-38
10. Summary of Tactical Situations . . . . .	2-38
G. Effectiveness Measures (Evaluation Criteria) . . . . .	2-41
1. Effectiveness Concept . . . . .	2-41
2. Measures of Effectiveness . . . . .	2-42
3. Effectiveness Qualities - Combat Effectiveness Components . . . . .	2-48

SECTION III METHODOLOGY FOR THE PRESENTATION OF RESULTS

A. Organization of Results . . . . .	3-1
B. Data Presentation Format . . . . .	3-1
C. Explanation and Description of Data . . . . .	3-3
1. Performance and Statistical Probability Measures . . . . .	3-3
2. Combined Use of Descriptive Performance Measures and Statistical Probability Data . . . . .	3-6
3. Standard Scores . . . . .	3-7
4. SAWS Target Effects and Overall Effectiveness Scores . . . . .	3-10
5. Expected Scores . . . . .	3-11
6. Graphical Presentation of Measures as a Function of Time and Range . . . . .	3-12
7. Histogram (Bar Graph) Presentation of Near Misses as a Function of Target Location . . . . .	3-18
D. Analysis and Derivation of Conclusions . . . . .	3-20

CONTENTS (Continued)

SECTION IV TRAINING RESULTS

- A. Rifle . . . . . 4-1
  - 1. Disassembly and Assembly . . . . . 4-1
  - 2. Trainfire Record Range . . . . . 4-3
  - 3. 25-meter Rifle in Automatic Mode . . . . . 4-7
  - 4. 200-meter Rifle in the Automatic Mode . . . . . 4-7
- B. Automatic Rifle . . . . . 4-9
  - 1. Disassembly and Assembly . . . . . 4-9
  - 2. Interim Transition Record . . . . . 4-9
  - 3. 25-meter Automatic Rifle . . . . . 4-9
- C. Machinegun . . . . . 4-9
  - 1. Assembly and Disassembly . . . . . 4-9
  - 2. Record Firing, Tables II, III, and IV . . . . . 4-9
- D. Contamination of Training Scores by Weather . . . . . 4-17

SECTION V MATERIEL RELIABILITY RESULTS

- A. Purpose of Reliability Data . . . . . 5-1
- B. Data Collected and Observations . . . . . 5-2
- C. Reliability Results and Findings . . . . . 5-2
  - 1. Major Causes of Malfunctions in US 7.62mm Weapons . . . . . 5-7
  - 2. Major Causes of Malfunctions in 5.56mm Weapons . . . . . 5-7
- D. Effect of Malfunctions on Experimentation . . . . . 5-12

SECTION VI SQUAD WEAPON MIX FIRE EFFECTIVENESS RESULTS

- A. Rifle Squad Experiment . . . . . 6-1
  - 1. Situation 1: Rifle Squad in Line Assault . . . . . 6-1
  - 2. Situation 2: Rifle Squad as Base of Fire Supporting the Assault . . . . . 6-20
  - 3. Situation 4: Rifle Squad in Approach to Contact . . . . . 6-37
  - 4. Situation 5: Rifle Squad as a Base of Fire Supporting the Advance . . . . . 6-48
  - 5. Situation 7: Rifle Squad in Defense Against Attack . . . . . 6-69

CONTENTS (Continued)

6.	Situation 8: Rifle Squad in Night Defense Against Attack . . . . .	6-78	
7.	Combined Results - Rifle Squad Experiment . . . . .	6-89	
B.	Supplementary Rifle Squad Experiment . . . . .	6-93	
1.	MC Versus MB . . . . .	6-93	
2.	CX Versus CY . . . . .	6-93	
3.	MC Versus CY . . . . .	6-96	
C.	Machinegun Squad Experiment . . . . .	6-99	
1.	Situation 3: Machinegun Squad in Fire Support of the Assault . . . . .	6-99	
2.	Situation 5A: Machinegun Squad as a Base of Fire Supporting the Advance (375 to 560 meters) . . . . .	6-99	
3.	Situation 6: Machinegun Squad in Fire Support of the Advance (446 to 753 meters) . . . . .	6-100	
4.	Situation 9: Machinegun Squad in Defense Against Attack . . . . .	6-101	
5.	Discussion . . . . .	6-101	
SECTION VII DUPLEX AMMUNITION EXPERIMENT			
A.	Rifle Duplex Ammunition Experiment . . . . .	7-1	
B.	Automatic Rifle Duplex Ammunition Experiment . . . . .	7-18	
C.	M60 Machinegun Duplex Ammunition Experiment . . . . .	7-18	
SECTION VIII LETHALITY DATA IMPLICATIONS . . . . .			8-1
SECTION IX CONCLUSIONS . . . . .			9-1

Part Two: Annexes

ANNEXES

- A Squad Organization and Operational Policies
- B Ranges, Instrumentation, and Data Collection
- C Materiel
- D Correlation Analysis
- E Small Arms Lethality

CONTENTS (Continued)

F	Bibliography	
G	Distribution	
<b>Figures</b>		
2-1	US 7.62mm Weapons . . . . .	2-3
2-2	Colt 5.56mm Weapons . . . . .	2-4
2-3	Stoner 63 5.56mm Weapons . . . . .	2-5
2-4	Soviet-type 7.62mm Weapons . . . . .	2-6
2-5	Types of Ammunition . . . . .	2-7
2-6	Standing, Kneeling, and Head and Shoulder Targets	2-13
2-7	Acoustic Near Miss Sensor . . . . .	2-14
2-8	Panel Near Miss Sensor . . . . .	2-14
2-9	Situation 1, Range A . . . . .	2-28
2-10	Situation 2, Range A . . . . .	2-29
2-11	Situation 3, Range A . . . . .	2-31
2-12	Situation 4, Approach to Contact, Range B . . . . .	2-32
2-13	Situation 4, Range B . . . . .	2-33
2-14	Situation 5, Range B . . . . .	2-34
2-15	Situation 6, Range B . . . . .	2-36
2-16	Situation 7, Range C . . . . .	2-37
2-17	Situation 8, Range C . . . . .	2-39
2-18	Situation 9, Range C . . . . .	2-40
2-19	Example of Sustainability . . . . .	2-46
3-1	Distribution of Data, Hypothetical Weapon-Squad Mix A and Mix B in Situation 1 . . . . .	3-14
3-2	Distribution of Data, Hypothetical Weapon-Squad Mix C in Situation 2 . . . . .	3-15
3-3	Example of CET as a Function of Range . . . . .	3-17
3-4	Histogram (Bar Graph) Presentation, Near Misses as a Function of Target Location . . . . .	3-19

CONTENTS (Continued)

4-1	Disassembly Time of Rifles . . . . .	4-4
4-2	Assembly Time of Rifles . . . . .	4-5
4-3	Disassembly Time of Automatic Rifles . . . . .	4-11
4-4	Assembly Time of Automatic Rifles . . . . .	4-12
4-5	Disassembly Time of Machineguns . . . . .	4-15
4-6	Assembly Time of Machineguns . . . . .	4-16
4-7	Range 19 Record Scores as a Function of Time of Day . . . . .	4-19
4-8	Range 18 Record Scores as a Function of Haze Conditions . . . . .	4-19
4-9	Rifle Squad Technique of Fire Range (Linear Targets) . . . . .	4-20
4-10	Rifle Squad Technique of Fire Range (Oblique Targets) . . . . .	4-21
4-11	Rifle Squad in Approach to Contact Range . . . . .	4-22
4-12	Rifle Squad in Assault Range . . . . .	4-23
4-13	Squad in Defense Range (Rifle or Machinegun) . . . . .	4-24
4-14	Machinegun Support of Attack Range . . . . .	4-25
4-15	Machinegun Support of Assault Range . . . . .	4-26
6-1	Summary of Results--Situation 1 . . . . .	6-5
6-2	Vertical Profile--Situation 1 . . . . .	6-7
6-3	Cumulative Number of Near Misses and Targets Hit--Situation 1 . . . . .	6-8
6-4	Number and Distribution of Near Misses --Situation 1 . . . . .	6-14
6-5	Summary of Results--Situation 2 . . . . .	6-23
6-6	Vertical Profiles--Situation 2 . . . . .	6-25
6-7	Cumulative Number of Rounds Fired, Targets Hit, Near Misses, and Percent of Ammunition Remaining--Situation 2 . . . . .	6-26
6-8	Number and Distribution of Near Misses --Situation 2 . . . . .	6-32



CONTENTS (Continued)

6-9	Summary of Results--Situation 4 . . . . .	6-41
6-10	Cumulative Number of Targets Hit and Percent of Ammunition Remaining--Situation 4 . . . . .	6-43
6-11	Summary of Results--Situation 5 . . . . .	6-51
6-12	Summary of Results--Situation 5 (Array X) . . . . .	6-53
6-13	Summary of Results--Situation 5 (Array Y) . . . . .	6-55
6-14	Cumulative Number of Rounds Fired, Targets Hit, Near Misses, and Percent of Ammunition Remaining --Situation 5 . . . . .	6-57
6-15	Number and Distribution of Near Misses --Situation 5 . . . . .	6-63
6-16	Summary of Results--Situation 7 . . . . .	6-71
6-17	Cumulative Exposure Time, Targets Hit, Rounds Fired, Total Hits, and Percent of Ammunition Remaining . . . . .	6-73
6-18	Summary of Results--Situation 8 . . . . .	6-81
6-19	Cumulative Exposure Time--Situation 8 . . . . .	6-83
7-1	Cumulative Number of Targets Hit--Situation 1 . . . . .	7-7
7-2	Number and Distribution of Near Misses-- Situation 1 . . . . .	7-8
7-3	Cumulative Number of Targets Hit--Situation 2 . . . . .	7-9
7-4	Number and Distribution of Near Misses-- Situation 2 . . . . .	7-10
7-5	Cumulative Number of Targets Hit--Situation 4 . . . . .	7-11
7-6	Cumulative Number of Targets Hit--Situation 5 . . . . .	7-12
7-7	Number and Distribution of Near Misses-- Situation 5 . . . . .	7-13
7-8	Cumulative Exposure Time--Situation 7 . . . . .	7-14
7-9	Cumulative Exposure Time--Situation 8 . . . . .	7-14
7-10	Cumulative Number of Targets Hit . . . . .	7-25
7-11	Cumulative Exposure Time . . . . .	7-27
7-12	Number and Distribution of Near Misses-- Situation 1 . . . . .	7-28

**CONTENTS (Continued)**

7-13	Cumulative Number of Targets Hit-- Situation 3 . . . . .	7-34
7-13	Cumulative Number of Targets Hit-- Situation 4 . . . . .	7-35
7-14	Number and Distribution of Near Misses --Situation 3 . . . . .	7-36
7-14	Number and Distribution of Near Misses --Situation 6 . . . . .	7-37
7-15	Cumulative Exposure Time--Situation 9 . . . . .	7-38
 <b>Tables</b>		
2-1	Comparative Weight and Ammunition Basic Loads by Weapons . . . . .	2-9
2-2	Squad Weapon Mixes and Squad Ammunition Basic Loads . . . . .	2-12
2-3	Basic Marksmanship Rifle Instruction . . . . .	2-17
2-4	Basic Marksmanship Automatic Rifle Instruction . . . . .	2-19
2-5	Basic Marksmanship Machinegun Instruction . . . . .	2-19
2-6	Transition Training . . . . .	2-20
2-7	Personnel Trained and Cross-trained . . . . .	2-21
2-8	Hypothetical Example of Cumulative Exposure Time (CET) . . . . .	2-45
Subtable A	Cumulative Exposure Times . . . . .	3-5
Subtable H	Cumulative Exposure Time p Factors . . . . .	3-5
4-1	Rifle and Assembly Test . . . . .	4-2
4-2	Rifle Record Fire Qualification Scores . . . . .	4-6
4-3	Average Number of Hits by Rifle in Automatic Mode (25-meter Range) . . . . .	4-8
4-4	Average Number of Hits by Rifle in Automatic Mode (200-meter Range) . . . . .	4-8
4-5	Automatic Rifle Disassembly and Assembly Tests . . . . .	4-10
4-6	Automatic Rifle Interim Transition Record . . . . .	4-13
4-7	Automatic Rifle Average Hits Underarm (Unsupported) and Hip/ling Positions (25-meter Range) . . . . .	4-13

CONTENTS (Concluded)

4-8	Machinegun Disassembly and Assembly Tests . . . . .	4-14
4-9	Machinegun Tables II, III, IV Average Number of Hits . . . . .	4-17
5-1	Malfunctions and Stoppages of Weapons . . . . .	5-3
5-2	Malfunctions Rates . . . . .	5-5
Table a	Sum of Raw Scores Across All Targets (Events Weighted Unequally) . . . . .	6-38
Table b	Average of 12 Event Standard Scores (Events Weighted Equally) . . . . .	6-38
Table c	Ambush Event (10 Targets - 21 to 34 Meters) . . . . .	6-39
6-1	Effects of Special Weapon Mixes . . . . .	6-94
6-2	Comparative Scores of Special Weapon Mixes . . . . .	6-97
7-1	Raw Score Results (Rifle Duplex Experiment) . . . . .	7-2
7-2	Expected Duplex Score (Rifle Duplex Experiment) . . . . .	7-5
7-3	Expected Duplex Scores Compared With Top Ranked Rifle Mixes (Rifle Duplex Experiment) . . . . .	7-16
7-4	Raw Score Results (Automatic Rifle Duplex Experiment) . . . . .	7-19
7-5	Expected Duplex Scores (Automatic Rifle Duplex Experiment) . . . . .	7-21
7-6	Raw Score Results (Machinegun Duplex Experiment) . . . . .	7-23
7-7	Expected Duplex Scores (Machinegun Duplex Experiment) . . . . .	7-32

## ABSTRACT

Field experimentation was conducted to determine the relative effectiveness of rifle and machinegun squads armed with US 7.62mm, Soviet 7.62mm, Colt 5.56mm and Stoner 5.56mm weapons. This report describes the experiment, the effectiveness measures used, the results, and the conclusions. Results are concerned with training, materiel reliability, and the fire effectiveness of squads armed with the different weapons and firing both simplex and duplex ball ammunition. Measures of effectiveness were the level of target effects and the ability of the weapons to sustain the effects. Data includes the number of targets hit, total number of hits on targets, number of near misses as an indication of suppressive effects, and the amount of ammunition expended--all as a function of time. Squad size, organization, and weapon system weight were held constant.

Squads armed with low impulse 5.56mm weapons were superior to squads armed with 7.62mm weapons in target effects, sustainability of effects, and overall effectiveness. Duplex ball ammunition was generally superior to simplex ball ammunition at close ranges. Data are related to lethality indices in a separate classified annex. Considerations of lethality support experimentation results indicating the superiority of 5.56mm weapons.

## FOR OFFICIAL USE ONLY

### SECTION I

#### INTRODUCTION

This report describes USACDCEC SAWS (small arms weapon systems) field experimentation completed 21 February 1966. A previous USACDCEC SAWS report, dated 31 January 1966, included only the experimentation completed by 24 December 1965.

This report supersedes the 31 January report, updating it with the field experimentation and associated analyses conducted after 24 December. All conclusions of the previous report remain valid, but they have been supplemented. Additional input data refinements and a more precise treatment of computer produced data have resulted in some changes in the numerical data presented for some of the experimental situations. These data refinements accentuate and clarify differences in weapon mixes presented in the 31 January report but result in no significant changes in either the performance measures or the rank order of weapons.

The report consists of nine sections. This first section identifies the purpose, scope, objectives, phasing and location, concept and general conduct of the experiment. Section II details the experimentation design, including a description of the experimentation ranges and the effectiveness criteria used. Section III explains the method of data presentation and analysis. Sections IV, V, and VI present the results of the experiment as related to training, materiel reliability, and fire effectiveness, and Section VII presents the results of an experiment comparing simplex ball and duplex ball ammunition. Section VIII consists of a brief note on the implications of existing lethality data to the SAWS findings, referring the reader to a separate classified annex for the primary lethality analysis. Major USACDCEC conclusions of the SAWS experiment and analysis are presented in Section IX. Reference data are contained in Annexes A through C. A separate volume is planned to provide detailed engineering design information and specifications of the instrumentation used in the SAWS experiment.

#### A. PURPOSE

The purpose of the SAWS field experiment was to assist in the evaluation of designated candidate small arms weapon systems as part of the Army-wide SAWS program.

#### B. SCOPE

The following specific experimentation tasks were assigned by USACDC directives:

1. Determination of the relative fire effectiveness of dismounted squads armed with various mixes of rifles, automatic rifles, and machine-guns, including Soviet-type weapons.

2. Determination of the relative fire effectiveness of squads armed with standard US 7.62mm weapons firing duplex ball ammunition, compared with squads firing ball ammunition.

3. Provision of certain data, such as firing scores, that might provide some insight into the relative ease or quality of training afforded by the different weapon systems, as a byproduct of the preparatory training phase of the experiment.

### C. OBJECTIVES

The outline plan approved by USACDC assigned eight main objectives:

1. As a byproduct of experimental design, development of a quantitative effectiveness criterion by which rifle and machinegun squads armed with candidate weapon systems, can be compared under tactical conditions.

2. Provision of hard data for determining the combat effectiveness of candidate weapons within an organizational and tactical context.

3. Provision of data to assist in determining the increases or decreases, if any, in manpower implied by the candidate weapon systems for use in cost effectiveness analysis.

4. Provision of comparative data on the tactical ammunition consumption rates of candidate weapons, relative to target effects achieved, as one input into cost effectiveness studies of increases or decreases in ammunition requirements implied by the various weapons.

5. As a byproduct of the preparatory training phase of the experiment, provision of data on the relative training effectiveness of the candidate weapons.

6. Identification of weapon characteristics that produced superior fire effectiveness within an experimental organizational and tactical context.

7. Provision of data resulting from the field experimentation for use in computer simulation.

8. Contribution to such Infantry Rifle Unit Study (IRUS) answers as the SAWS project can practically afford without prejudice to the constraints of time, resources, and SAWS objectives.

#### D. PHASING AND LOCATION

The experiment was accomplished at Fort Ord in four phases.

Phase I -- Preparation (23 February 1965-30 September 1965)

Phase II -- Training (24 August 1965-21 October 1965)

Phase III -- Field Experimentation (22 October 1965-21 February 1966)

First Increment (22 October 1965-24 December 1965)

Second Increment (3 January 1966-21 February 1966)

Phase IV -- Analysis and Reporting (18 December 1965-10 May 1966)

#### E. CONCEPT

The experiment was conducted to determine the relative fire effectiveness of rifle squads and machinegun squads armed with candidate weapons in the context of rifle platoons and companies in various tactical situations. Squad weapon system weight and the size and control structure of the squad were held constant. Squads were armed with the candidate weapon systems and Soviet-type weapons. The squads were then employed in the same representative tactical situations on instrumented ranges using selected firing techniques.

The experiment was unique because it integrated the following related aspects of the experimental design:

- 1) Evolution and application of a meaningful measure of combat fire effectiveness of infantry squads
- 2) Procurement and installation of instrumentation to sense and record events that supported the measure of fire effectiveness as a function of time and target arrays that realistically simulate an enemy in tactical situations
- 3) Assignment of enough soldiers (975) as experimentation subjects to allow the assignment of six independent squads to each weapon mix, permitting a balancing of runs to reduce the effects of differences in individuals and extraneous variables in the environment.

## F. CONDUCT OF EXPERIMENT

The experiment was designed to provide immediate answers for the SAWS evaluation while concurrently making a long term contribution to knowledge of the effectiveness of infantry small arms in a tactical and organizational context in support of IRUS.

USACDCEC used 975 experimentation subjects in the experiment, with the subjects organized into infantry squads armed with candidate weapon mixes. The squad weapon mixes were evaluated in nine meaningful tactical situations on three instrumented ranges. A total of 1007 record runs were conducted.

The field experiment was conducted in a platoon framework employing nine-man rifle squads and seven-man machinegun squads. The instrumented ranges provided target arrays consisting of targets that simulated the important aiming cues associated with personnel targets. The design of the instrumentation permitted collection of target hits, near misses, and rounds fired as a function of time, all of which can be related to various combat firing distances. The sensing and recording of data was largely automated. The large number of record runs and the depth of data established a data base that has been only partially analyzed for this report.

Formal weapon training was conducted to ensure that all personnel were equally qualified, to the extent possible, to participate as experimentation subjects.

Exploratory firing was conducted to obtain data for assessing best firing techniques, to identify operational policies, to validate safety and control procedures, and to evolve the most meaningful tactical situations.

The first increment of field experimentation, conducted from 22 October 1965 to 24 December 1965, addressed the objectives assigned and provided the data base for the initial findings and main conclusions of the 31 January 1966 report. The first increment also identified the need for additional high priority experimentation. This follow-on experimentation, from 3 January to 21 February 1966, completed the initially planned and follow-on experiments. Completion of this additional field experimentation has allowed the initial findings to be refined and expanded.



## SECTION II EXPERIMENTAL DESIGN

Part A describes the general characteristics of the experiment. Part B describes the weapons used in the experiment and the manner in which they were organized into mixes of weapon types in a squad context. Part C provides a broad general description of the instrumentation and equipment used in the experiment. (A detailed description of instrumentation appears in Annex B.) Part D discusses the organization, control, and training of personnel. (The training programs and implications of training for the various weapons are more fully discussed in Section IV.) Part E details experimentation procedures, including operational policies and administrative procedures. The control and balance of experimental variables is discussed in this section. Part F details each of the experimental tactical situations used to evaluate the performance of the various weapon mixes. The SAWS combat effectiveness criteria are outlined in Part G, and their value in the SAWS analysis is discussed here.

### A. GENERAL CHARACTERISTICS OF THE DESIGN

The USACDCEC field experiment was designed to measure the fire effectiveness of three US and one foreign weapon families in a small unit organizational context and in representative tactical situations. To achieve this objective, three tactical ranges were constructed, each representing separate but related squad tactical situations. Each range provided two rifle squad situations and one machinegun squad situation; the experiment encompassed six rifle squad and three machinegun squad scenarios.

Instrumented target arrays were laid out for each tactical situation and targets were programmed to appear to the experimentation subjects, in conjunction with the firing of weapons simulators, in a way that would provide subjects visual and audible target cues normally encountered in combat. Instrumentation designed to measure near misses in relation to targets was used on two of the ranges. All target elements were designed to detect hits (and some to detect near misses) as a function of time. Important qualities of the experiment are the recording of events as a function of time and the inclusion of near misses as an indication of suppressive effects. Included in the experiment are three primary design elements: 1) the competing weapons and their associated mixes within a constant size organization, 2) the targets and their associated instrumentation, and 3) the tactical situations embodied in the three ranges.

**B. EXPERIMENTATION MATERIEL**

**1. Weapons and Ammunition**

The experimentation weapons consisted of 13 weapons of four families. The weapons, listed below, are illustrated in Figures 2-1 through 2-4.

<u>US 7.62mm</u>	<u>Colt 5.56mm</u>	<u>Stoner 5.56mm</u>	<u>Soviet 7.62mm</u>
M14 rifle	M16E1 rifle	Stoner rifle	AK47 rifle
M14E2 AR*	Colt AR	Stoner AR	- - -
M60 bipod MG**	- - -	Stoner bipod MG	RPD (squad level) bipod MG
M60 tripod MG	- - -	Stoner tripod MG	DPM (company level) bipod MG

Weapons of the US 7.62mm family and the M16E1 rifle of the Colt family are currently standard US weapons. The other 5.56mm weapons (Colt automatic rifle and Stoner family) are US developmental weapons. Weapons of the Soviet family are Soviet-type weapons found in several armies. Those used in the experiment were manufactured in East Germany, the Soviet Union, and Communist China; parts and ammunition were interchangeable. The Stoner family was designed for maximum interchangeability of parts and components between weapon types, although the other weapon families also possess varying degrees of interchangeability of parts between weapon types.

A basic purpose of this experiment, implied in the candidate weapons selected, was to evaluate fire effectiveness of low muzzle impulse and high muzzle impulse weapons.\*\*\* The Stoner and Colt 5.56mm systems are of the low muzzle impulse type. The standard US 7.62mm weapons are high muzzle impulse weapons firing the standard US 7.62mm (NATO) cartridge. The Soviet rifle and RPD squad-level machinegun cartridges are considered intermediate impulse cartridges, while the Soviet company-level machinegun (DPM) fires a cartridge with energy similar to the US 7.62mm (NATO) cartridge. Figure 2-5 illustrates the ammunition types used in the SAWS Field Experiment.

The nominally standard US 7.62mm duplex cartridge has two tandem loaded 7.62mm projectiles that together weigh slightly more than

\* AR - Automatic Rifle

\*\* MG - Machinegun

\*\*\* Table C-6 (Annex C) presents the comparative ammunition characteristics of low impulse 5.56mm ammunition and high impulse US 7.62mm ammunition.

M14 Rifle

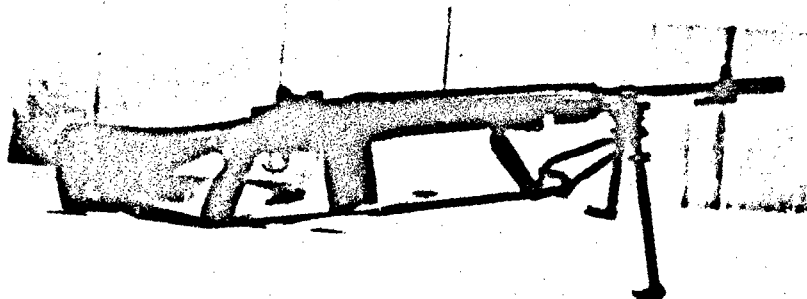
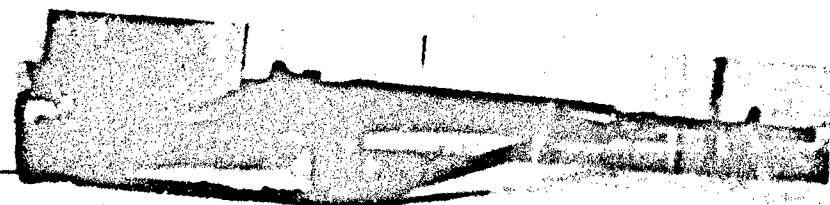

M14E2 Automatic Rifle

M60 Machinegun, Bipod Mounted

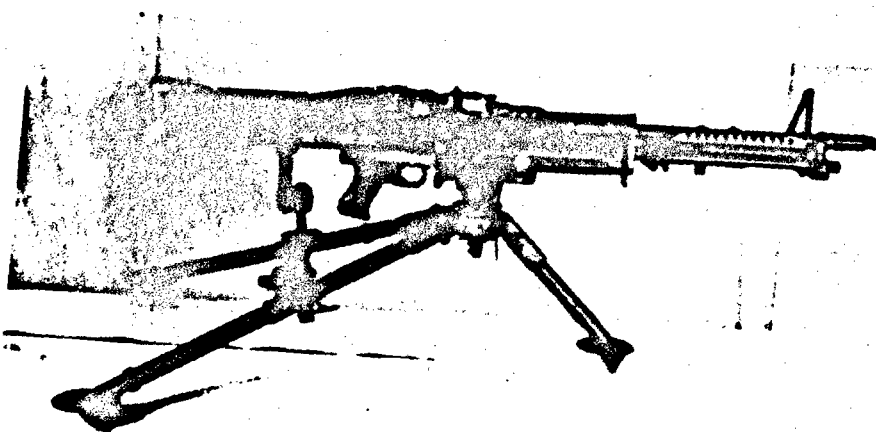
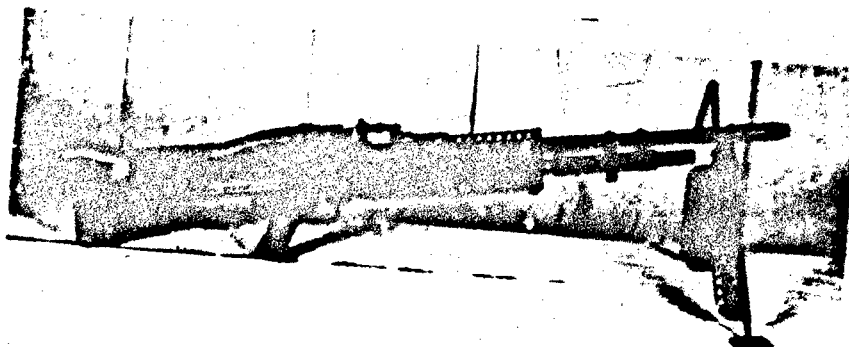

M60 Machinegun, Tripod Mounted

Figure 2-1 US 7.62mm WEAPONS

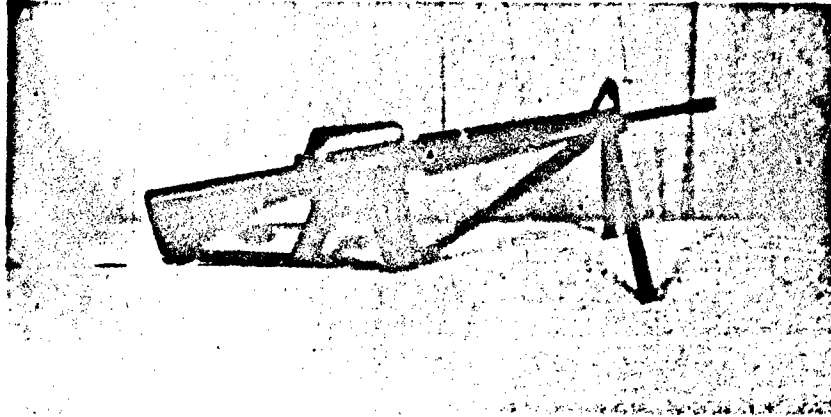

**M16E1 Rifle**

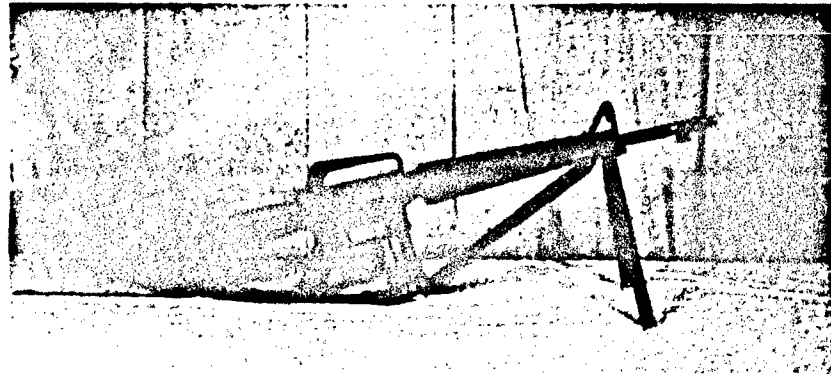

**Colt Automatic Rifle**

**Figure 2-2 COLT 5.56mm WEAPONS**

Rifle

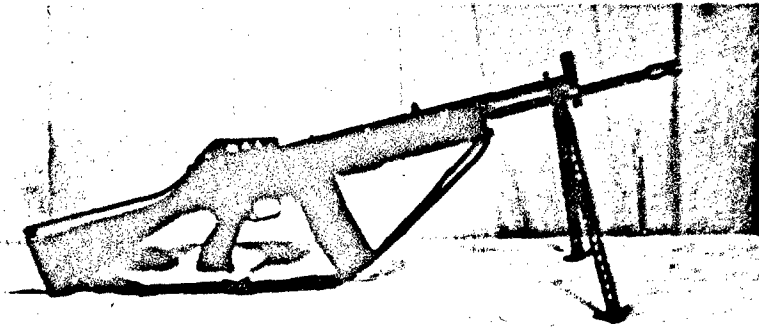

Automatic Rifle

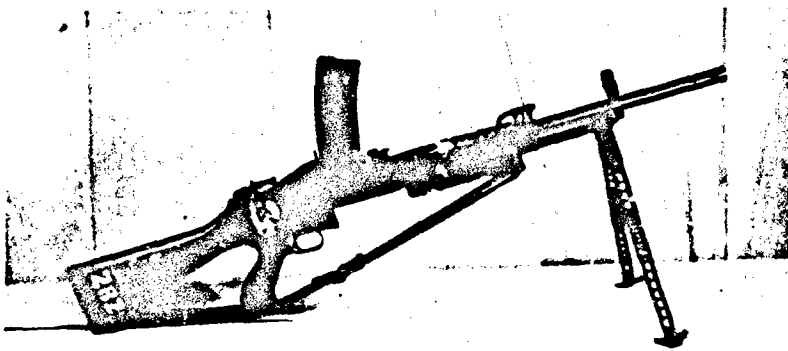

Machinegun,  
Bipod Mounted

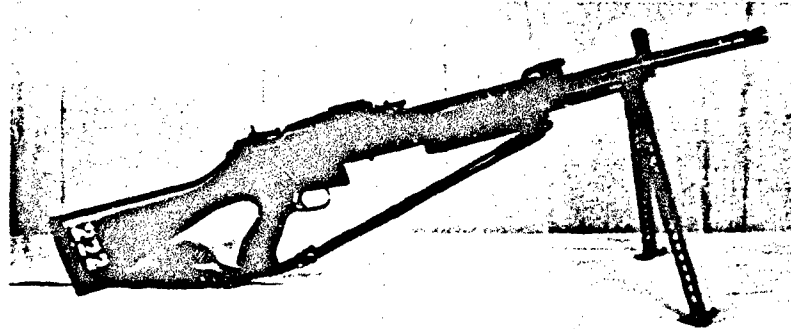

Machinegun,  
Tripod Mounted

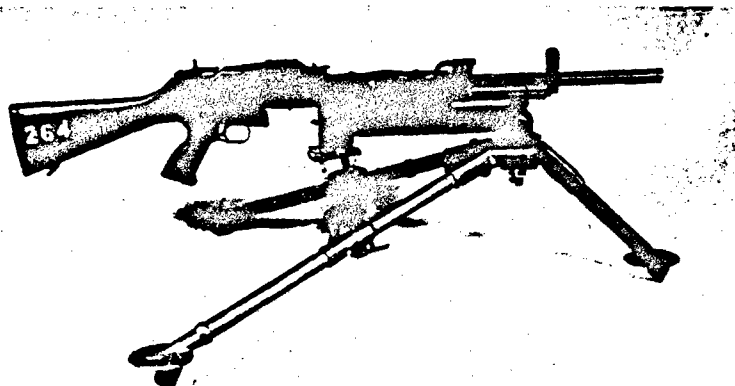
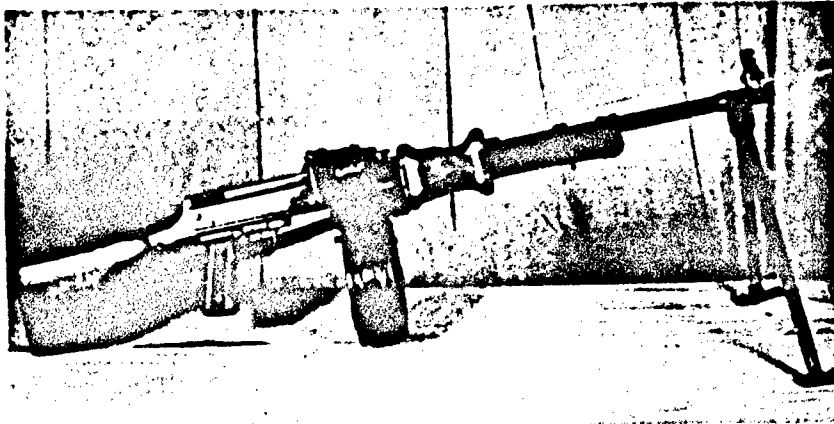
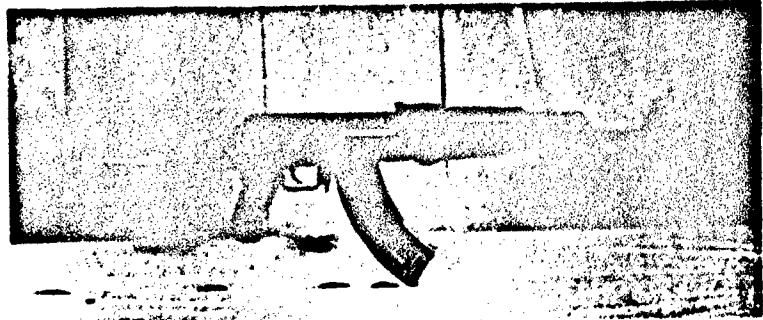
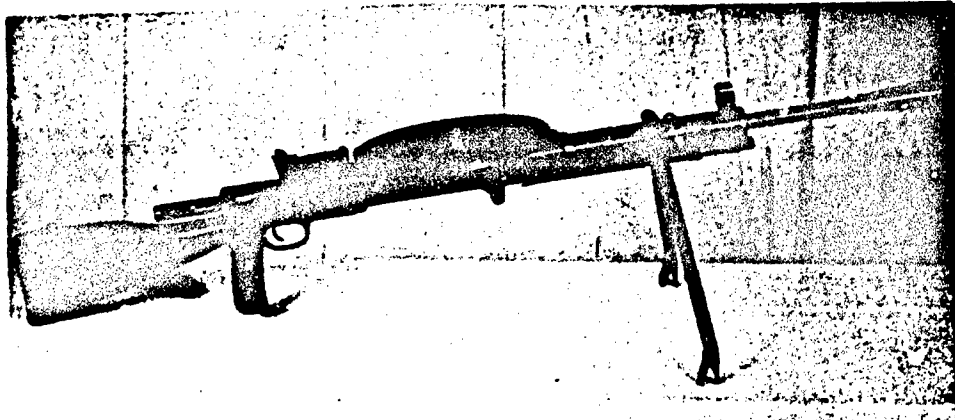

Figure 2-3 STONER 63 5.56mm WEAPONS  
2-5

AK47 Rifle



RPD Machinegun,  
Bipod Mounted



DPM Machinegun, Bipod Mounted

Figure 2-4 SOVIET-TYPE 7.62mm WEAPONS

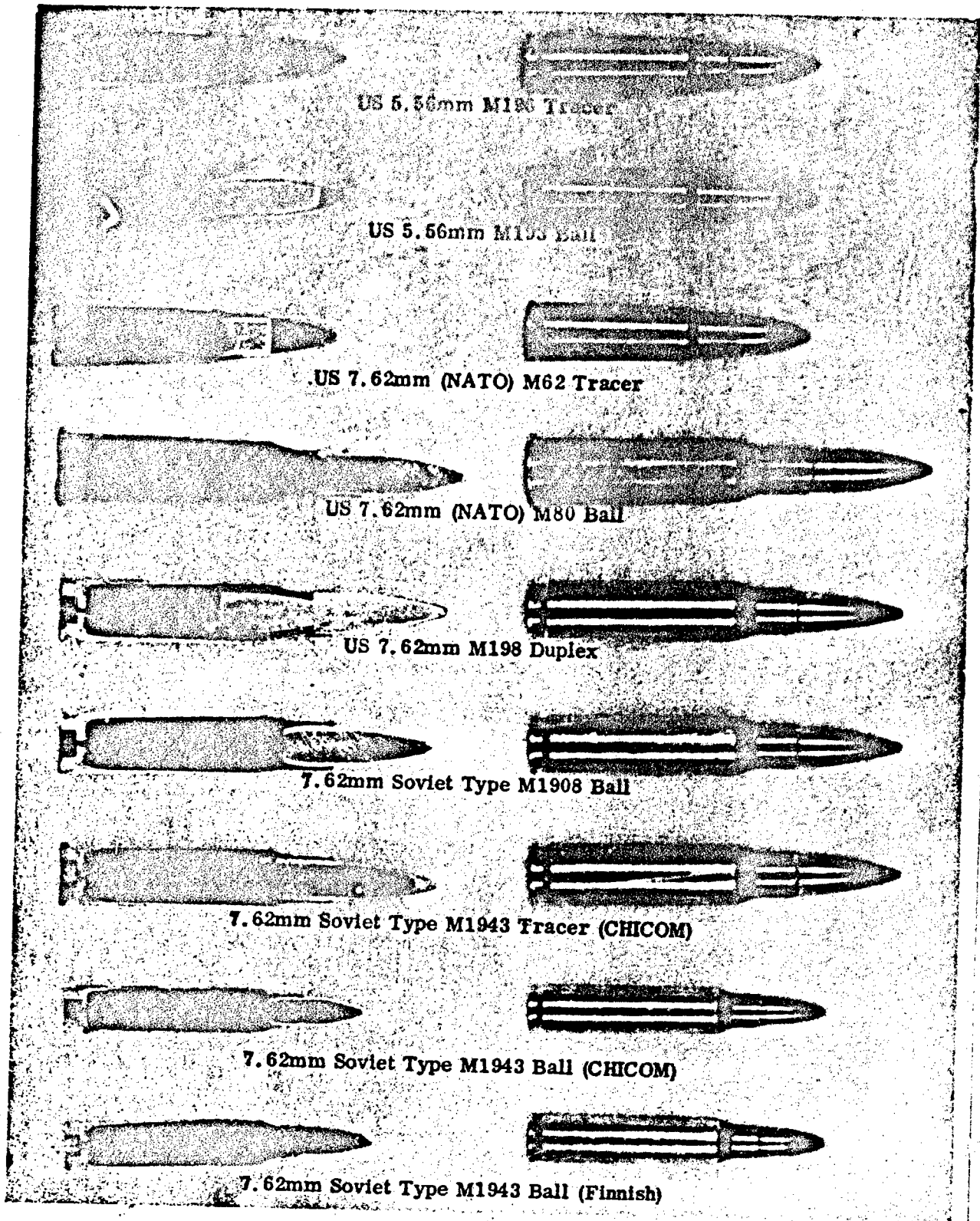

Figure 2-5 TYPES OF AMMUNITION

the standard simplex projectile and have a lower velocity than the simplex round. The duplex round was designed to increase hit probability at ranges to about 300 meters.

Details of weapons and ammunition characteristics are listed in Annex C.

The candidate weapons, ammunition, and spare parts for the experiment were selected and provided by the Army Materiel Command (AMC). Except for the Soviet-type weapons, the weapons were in new condition when USACDCEC received them.

Weight characteristics of the candidate and Soviet weapons are summarized in Table 2-1. This table also shows the weapon ammunition basic loads used in this experiment. System weights used in determining the relative fire effectiveness of the experimentation weapons were those of the current standard 7.62mm weapons with currently prescribed basic loads. These weights were adopted to hold squad systems weight constant and the weights represent current Army weight doctrine; these current ammunition loads have been determined to approach the maximum permissible weight and to be heavier than desirable.\* For detailed comparative data on weapons and ammunition, see Annex C.

## 2. Organization of Materiel for Experimentation

For comparisons, system weights and the size and structure of the squad were held constant, but the weapon mixes were varied. These mixes are shown in Table 2-2.\*\* Squad ammunition basic loads for these weapon mixes, based on the individual weapon loads given in Table 2-1, are also shown in Table 2-2.

## C. INSTRUMENTATION

On each range were instrumented target arrays connected by buried cables to a control and recording van behind the firers. Each target element of an array consisted of some or all of the following components:

- 1) A target body with a hit sensor, representing a kneeling or standing soldier or the head and

\* A Study to Conserve the Energy of the Combat Infantryman, USACDC, 5 February 1964.

\*\* The squad weapons mixes were selected to permit comparison of the weapons for the SAWS experiment; they were also designed to provide building blocks of data that could be used, with an IRUS scaling experiment, to compute the small arms fire effectiveness of alternative squad, platoon, and company organization.



Table 2-1  
COMPARATIVE WEIGHT AND AMMUNITION BASIC LOAD

Item	Rifles in Rifle Squad					ARs and MGs in Rifle Squads				
	M14	M14E2	M16E1	Stoner	AK47	M14E2	Colt AR	Stoner AR	M60 Bipod MG	Stoner Bli MG
Weapon (unloaded)	9.69 lb	12.56 lb	6.87 lb	8.25 lb	8.75 lb	12.56 lb	8.00 lb	10.62 lb	24.37 lb	11.44 lb
Weapon (loaded)	11.27 lb	14.14 lb	7.87 lb <sup>A</sup>	9.52 lb <sup>B</sup>	10.87 lb <sup>B</sup>	14.14 lb	9.00 lb <sup>A</sup>	11.89 lb <sup>B</sup>	31.77 lb <sup>C</sup>	16.43 lb
Bipod and case		c	0.75 lb	1.32 lb		c	0.75 lb	1.32 lb	c	1.32 lb
Bipod										
Carbine barrel kit										
Ammunitions available at system weight current in Army 7.62mm weapon <sup>N</sup>	100 rd 17.59 lb	60 rd <sup>D</sup> (17.30 lb)	300 rd (17.62 lb)	180 rd (17.19 lb)	120 rd (17.23 lb)	260 rd 33.10 lb	724 rd (33.10 lb)	492 rd (33.08 lb)	120 rd <sup>H</sup> (33.08 lb)	600 rd (32.72 lb)
Weapon system weight equal numbers of rounds	17.59 lb 100 rd	20.46 lb (100 rd)	11.12 lb (100 rd)	14.15 lb (100 rd)	16.44 lb (100 rd)	33.10 lb 260 rd	17.50 lb (260 rd)	23.12 lb (260 rd)	48.41 lb <sup>I</sup> (260 rd)	21.56 lb (260 rd)

NOTE: System weights and ammunition basic loads for all weapons in rifle squad on one-man loads. Those for machinegun squads are based on three-man (a three-man gun team).

<sup>A</sup> 30-round aluminum magazine

<sup>B</sup> 30-round steel magazine

<sup>C</sup> Bipod organic to the weapon

<sup>D</sup> 60 rounds at rifle system weight; however, 80 rounds were allowed

<sup>E</sup> 100-round bandoleer

<sup>F</sup> 150-round bandoleer

<sup>G</sup> 100-round drum

<sup>H</sup> A rifleman was used as a caliber .45 pistol. Com' (17.59 lb) and the gunner ammunition in bandoleer

<sup>I</sup> Includes weight of the pistol

<sup>J</sup> 47-round drum

<sup>K</sup> 200-round metal box

<sup>L</sup> 900-round metal box

<sup>M</sup> System weight is based on 60 rounds of ammunition in ; for assistant gunner and ;

<sup>N</sup> Computed on the basis of cartridge is 5.55 percent

<sup>O</sup> Three 900-round metal boxes

**Table 2-1  
AMMUNITION BASIC LOADS BY WEAPON**

ARs and MGs in Rifle Squads				MGs in Machinegun Squads					
Stoner AR	M60 Bipod MG	Stoner Bipod MG	RPD MG	M60 Tripod MG	Stoner Tripod MG	DPM MG	M60 Bipod MG	Stoner Bipod MG	RPD MG
10.62 lb	24.37 lb	11.44 lb	14.93 lb	24.06 lb	10.81 lb	22.00 lb	24.37 lb	11.44 lb	14.93 lb
11.89 lb <sup>b</sup>	31.77 lb <sup>e</sup>	16.43 lb <sup>f</sup>	20.66 lb <sup>c</sup>	31.46 lb <sup>e</sup>	15.80 lb <sup>f</sup>	27.70 lb <sup>j</sup>	31.77 lb <sup>e</sup>	16.43 lb <sup>f</sup>	20.66 lb <sup>c</sup>
1.32 lb	c	1.32 lb	c			c	c	1.32 lb	c
				17.37 lb	19.37 lb				
				12.56 lb	5.87 lb	4.88 lb	12.56 lb	5.87 lb	
492 rd (33.08 lb)	120 rd <sup>m</sup> (33.08 lb)	600 rd (32.72 lb)	300 rd <sup>c</sup> (32.12 lb)	800 rd 129.65 lb <sup>m</sup> 900 rd 129.49 lb	2298 rd <sup>l</sup> (120.63 lb) 2545 rd <sup>f</sup> (129.63 lb)	752 rd <sup>j</sup> (126.98 lb)	1000 rd <sup>k</sup> (129.28 lb) 1123 rd <sup>e</sup> (129.60 lb)	2850 rd <sup>o</sup> (129.06 lb) 3059 rd <sup>f</sup> (129.63 lb)	1833 rd <sup>c</sup> (129.62 lb)
23.12 lb (260 rd)	48.41 lb <sup>i</sup> (260 rd)	21.56 lb (260 rd)	30.28 lb (260 rd)	129.65 lb 800 rd <sup>k</sup> 129.49 lb 900 rd <sup>e</sup>	74.18 lb (800 rd) <sup>l</sup> 74.89 lb (900 rd) <sup>f</sup>	132.73 lb (800 rd) <sup>j</sup>	112.59 lb (800 rd) <sup>k</sup> 112.43 lb (900 rd) <sup>e</sup>	56.76 lb (800 rd) <sup>l</sup> 57.47 lb (900 rd) <sup>f</sup>	69.67 lb (800 rd) <sup>c</sup>

basic loads for all weapons in rifle squads are based on three-man loads  
machinegun squads are based on three-man loads

<sup>m</sup> A rifleman was used as an ammunition bearer and armed with a caliber .45 pistol. Combined system weight for the rifleman (17.59 lb) and the gunner (33.10 lb) provided 294 rounds of ammunition in bandoleers for a total weight of 50.63 lb

<sup>b</sup> allowed <sup>i</sup> Includes weight of the pistol carried by the ammunition bearer

<sup>j</sup> 47-round drum

<sup>k</sup> 200-round metal box

<sup>l</sup> 900-round metal box

<sup>m</sup> System weight is based on weight of M60 tripod MG, 800 rounds of ammunition in metal boxes, and caliber .45 pistols for assistant gunner and ammunition bearer

<sup>n</sup> Computed on the basis of the ball cartridge, 7.62mm duplex cartridge is 5.55 percent heavier

<sup>o</sup> Three 900-round metal boxes plus a 150-round bandoleer

shoulders of a soldier in a foxhole, colored field green with a dirt-smearred decal face. (Figure 2-6)

- 2) A mechanism to raise and lower the target on computer command and to lower it when it was hit.
- 3) A target weapon signature simulator (weapon simulator) that provided realistic auditory and visual weapon cues of noise, blast and flash of a rifle, automatic rifle, or machinegun, according to computer programmed commands, and shut off when the target was hit (not all target elements had, or needed, simulators).
- 4) A near miss sensor to sense misses within 2 meters of the target body. These sensors were used for the target elements in five of the nine tactical situations. Two types of near miss sensors were used on different ranges: an acoustic sensor (Figure 2-7) at the shorter firing distances and a camouflaged panel sensor at the longer distances (Figure 2-8).

The individual target elements, grouped tactically in arrays, were programmed to give weapon signature cues and to raise and lower targets according to programmed exposure times. Exposure times were selected to portray movements representative of the combat situation being portrayed. The programmed total target exposure times for each situation are given in Appendix 4 to Annex B.

In addition to the target array instrumentation, microphones were placed at each static firing position to allow the rounds fired to be counted and recorded as a function of time. (Manual counts of remaining ammunition were made for the two tactical situations where experimentation subjects were moving.)

The control and recording van housed a control console and an on-line computer with a magnetic tape recorder. Reproducibility of target system behavior for each squad in a situation was provided by computer command program.

The following basic data were recorded as a function of time to the nearest 0.01 minute: hits (both first hits and any subsequent hits before the targets fell completely), near misses, target up and target

Table 2-2  
**SQUAD WEAPON MIXES AND SQUAD AMMUNITION BASIC LOADS A**

Nine-man rifle squad: squad leader and two four-man fire teams									
US 7.62mm Mix		Colt 5.56mm Mix		Stoner 5.56mm Mix		Soviet 7.62mm Mix		Hybrid Mix	
Weapons (No. and Type)	Load (rounds)	Weapons (No. and Type)	Load (rounds)	Weapons (No. and Type)	Load (rounds)	Weapons (No. and Type)	Load (rounds)	Weapons (No. and Type)	Load (rounds)
9 M14 rifles	1290	9 M16E1 rifles	3618	9 Stoner rifles	2352	9 AK47 rifles	1504	--	--
9 M14E2 rifles	1080	9 Colt ARs	3323	--	--	--	--	--	--
7 M14 rifles	1220	7 M16E1 rifles	3548	7 Stoner rifles	2244	--	--	--	--
2 M14E2 ARs		2 Colt ARs		2 Stoner ARs		--	--	--	--
5 M14 rifles	1088	--	--	7 Stoner rifles	2460	7 AK47 rifles	1440	7 M16E1 rifles	3322 <sup>B</sup>
2 M60 bipod MGs		--	--	2 Stoner bipod MGs		2 RPD bipod MGs		2 Stoner bipod MGs	
Seven-man machinegun squad: squad leader and two three-man machinegun teams									
2 M60 bipod MGs	2246 <sup>C</sup>			2 Stoner bipod MGs	6118 <sup>C</sup>	2 RPD bipod MGs	3678		
2 M30 tripod MGs	1600 <sup>D</sup>			2 Stoner tripod MGs	4596 <sup>D</sup>	2 DPM bipod MGs	1504		

<sup>A</sup>Basic loads at equal squad weapon systems weight: 189.33 pounds for rifle squad and 259.30 pounds for machinegun squad (See Table 2-1)

<sup>B</sup>1200 rounds (in bandoleers) for MGs, 2122 rounds for rifles

<sup>C</sup>In bandoleers

<sup>D</sup>In boxes

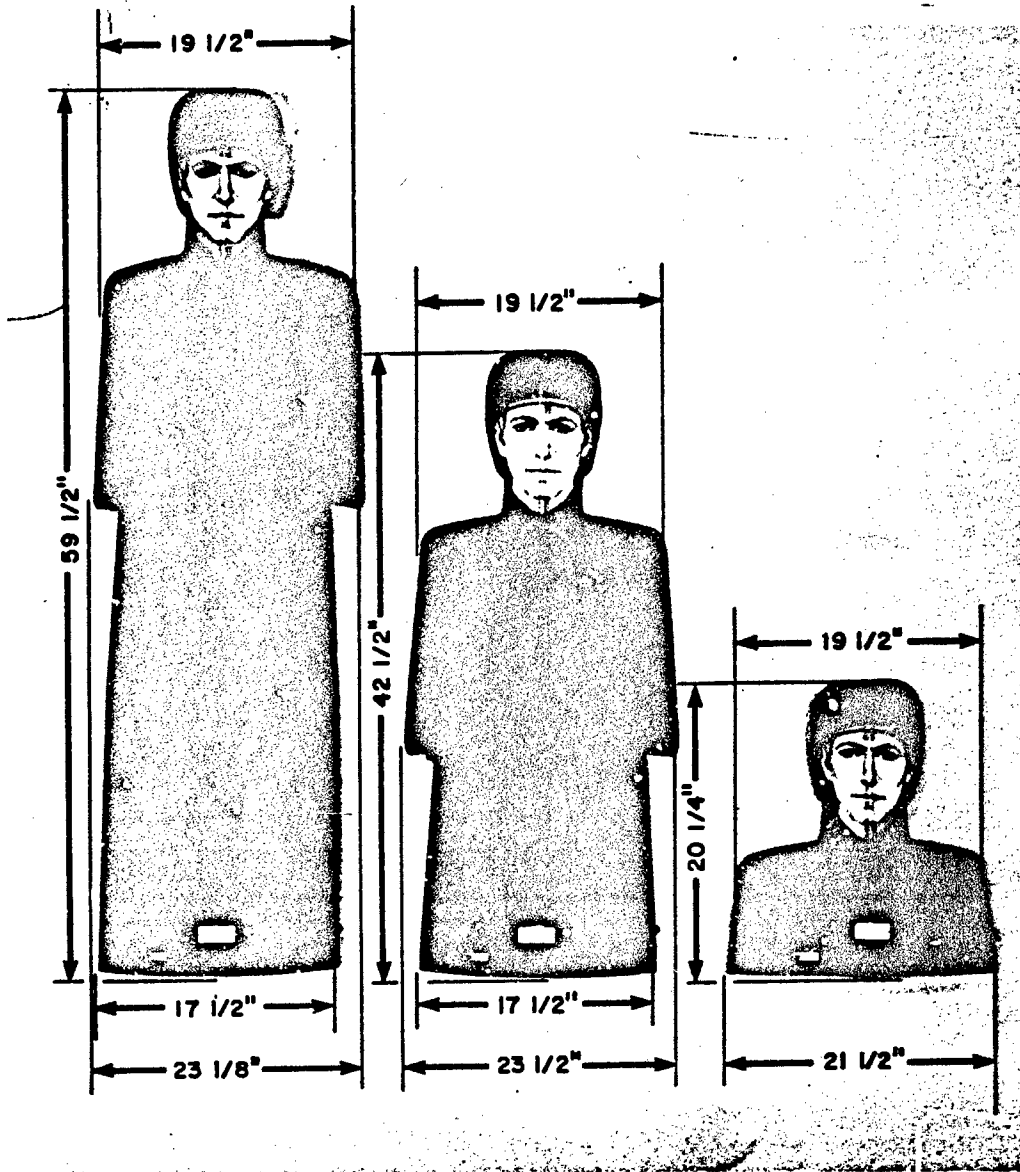

Figure 2-6  
STANDING, KNEELING, AND HEAD AND SHOULDER TARGETS  
(903, 623, 237 sq in. areas, respectively)

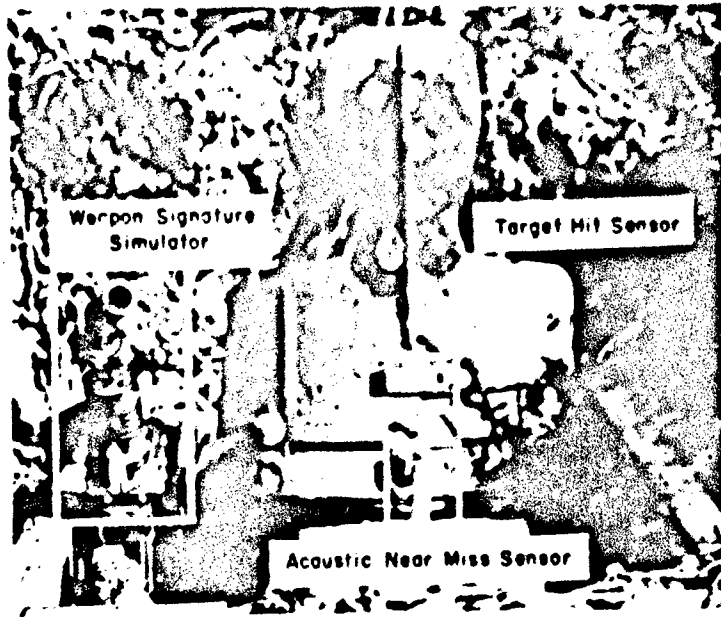

Figure 2-7 ACOUSTIC NEAR MISS SENSOR  
(Head and Shoulder Target)

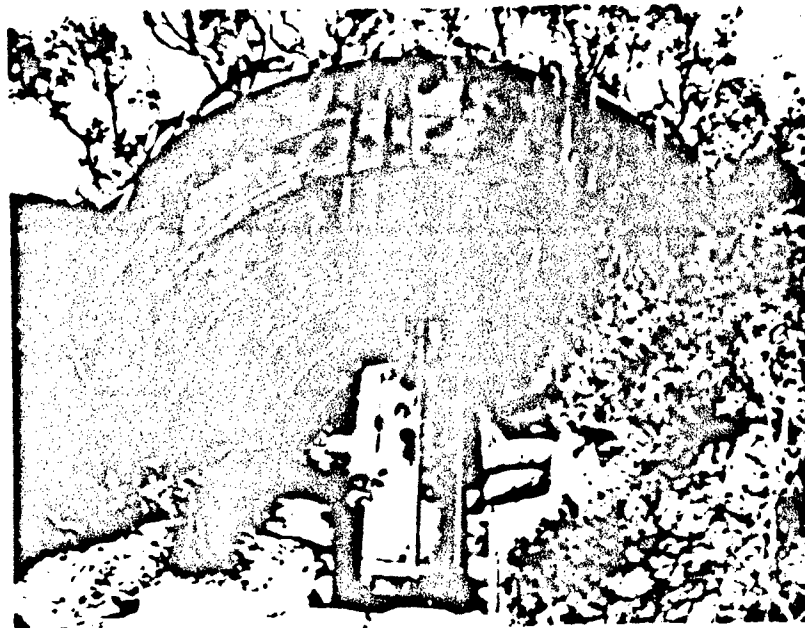

Figure 2-8 PANEL NEAR MISS SENSOR  
(Kneeling Target)

down, weapon signature simulator on and off, and rounds fired per weapon. The instrumentation was capable of discriminating between individual rounds to 5 milliseconds.

The instrumentation is described in further detail in Annex B. A supplemental detailed technical report will be published at a later date.

#### **D. EXPERIMENT PERSONNEL**

##### **1. Source of Support Personnel**

Support personnel for purposes of administrating and supporting the general conduct of the experiment (other than experimentation subjects) were from Project Team II, Experimentation Support Group, and the 194th Armored Brigade of USACDCEC.

##### **2. Source of Experimentation Subjects**

Experimentation subjects were provided by the 194th Armored Brigade. Subjects assigned to the six primary mixes--UA, UB, CA, CB, SA, and SB (the mixes equipped with nine rifles and with seven rifles and two automatic rifles)--were from infantry companies of the 41st Infantry Battalion. Subjects assigned to the other weapon mixes--SC, UC, UD, RA, and RC--were from armored and artillery units as well as from the 41st Infantry; they had all been previously trained and had qualified with the M14 rifle.

##### **3. Organization of Experimentation Subjects**

###### **a. Organization into Squad Weapon Mixes**

Experimentation subjects were organized into: (1) nine-man rifle squads consisting of a squad leader and two four-man fire teams, and (2) seven-man machinegun squads consisting of a squad leader, two machinegunners, two assistant machinegunners, and two ammunition bearers.

###### **b. Sample Size - Implications**

As far as practical, to randomize and balance uncontrolled variables--such as differences in the abilities of experimentation subjects, effects of weather, the effects of time of day (especially light), changing conditions of vegetation, and the motivational effects of proximity to weekends and holidays--six squads were assigned to each weapon mix. The use of six squads allowed them to be scheduled to fire in balanced matrices in each tactical situation with respect to date and time of day. A total of 105 squads, consisting of 975 experimentation subjects (including super-numeraries) was required.

**c. Matching of Personnel**

The number of personnel available allowed them to be assigned initially at random, on the basis of 72 men to the rifle mix--six nine-man experimentation squads plus nine-man squads from which supernumeraries were drawn to replace personnel lost for illness or other reasons--and 42 men to the machinegun mix. On completing the training phase, subjects were reassigned within their weapon type. The same number of experts, sharpshooters, and marksmen were assigned to each experimentation squad within a mix.

To conduct the experiment, special measures had to be taken to select experimentation subjects that could be retained for each phase of the experiment and, where necessary, to obtain their deferment from overseas levy.

Personnel records of all personnel were reviewed and cataloged, both at the time of initial assignment and at the completion of training, to ensure that personnel of all mixes were as closely equivalent as possible on all variables that could be expected to correlate with performance.

**4. Training Program for Experimentation Subjects**

The training phase of the experiment was conducted from 24 August to 21 October 1965 on Fort Ord Infantry Training Center ranges. Results of training tests and an analysis of the SAWS training program appear in Section IV (Training Results).

**a. Training Objectives**

Training objectives were to make all personnel proficient with their respective SAWS weapons, and to obtain data on the relative effectiveness of training inherent to the various weapons.

**b. Training Program**

The training program consisted of basic marksmanship and transition training, and followed current Army marksmanship courses outlined in Army Subject Schedules 7-111 and 7-112 dated November 1964; FM 23-71 dated July 1964; FM 23-16 dated June 1965; and FM 23-67 dated October 1964.

**(1) Basic Marksmanship Instruction**

Basic marksmanship instruction included mechanical training, instructional and qualification firing, target detection, and night firing. Where weapon differences prevented combined training--for



**Table 2-3**  
**BASIC MARKSMANSHIP**  
**RIFLE INSTRUCTION**

Subject	Total Hours	Ammunition per Firer
Orientation and Mechanical Training	4	0
Target Detection	6	0
Preparatory Marksmanship (25 meter firing)	14	132
Field Firing	4	56
Record Firing (includes 3 hours of concurrent target detection)	16	192
Night Firing	5	44
Familiarization of Automatic Technique	12	258
<b>Total</b>	<b>61</b>	<b>682</b>

**NOTE:** Modifications to Combat Readiness Marksmanship Proficiency Standard Course A1: Orientation and Mechanical Training was increased from 2 to 4 hours; Record Firing was increased from 8 to 16 hours to provide learning factors; Night Firing was increased from 2 to 5 hours to provide 3 hours of refresher on techniques; and familiarization of Automatic Fire Technique was included to prepare experimentation subjects for automatic firing with rifles.

example, mechanical training, sight adjustment and establishing battle-sight zero--qualified instructors using equivalent training aids and instructional material taught the experimentation subjects each weapon system separately. The hours of basic instruction presented are shown, with the ammunition used, in Tables 2-3, 2-4, 2-5, and summarized here:

Rifle Marksmanship (Combat                    61 hours  
Readiness Marksmanship  
Proficiency Standard Course

A-1, modified to include 12 hours of automatic fire)

Automatic Rifle Marksmanship 29 hours

Machinegun Marksmanship 34 hours  
(Tables I through VI)

(2) Transition Training

After completing basic marksmanship, rifle and machinegun squads were given separate transition training designed to train them to perform effectively as members of rifle and machinegun squads and to acquaint them with the safety and range procedures employed on the SAWS field experimentation ranges (Table 2-6).

Rifle squad transition training consisted of 24 hours of instruction as outlined in Army Subject Schedule 7-111 dated November 1964 and TC 23-9 dated January 1965. It included controlled tactical firing exercises in the approach to contact, assault, and defense.

Machinegun squad transition training consisted of eight hours of instruction in crew drill and controlled tactical firing exercises in support of the attack, support of the assault, and defensive firing.

c. Supplementary Training

Supplementary training was provided later to meet requirements caused by normal attrition and the need for new squads. This training was given at various times in November 1965, December 1965, and January 1966. The 228 personnel trained or cross trained as riflemen, automatic riflemen, or machinegunners are reflected in the totals shown in Table 2-7. Personnel who had received no previous training were given the full complement of training. Personnel being cross trained received instruction on disassembly, assembly, functioning, zero firing, automatic fire techniques, trigger manipulation, loading, and range safety as necessary. All personnel received equivalent amounts of training.

d. Training Facilities

Facilities used during training included classrooms and target detection and firing ranges. Infantry Training Center classrooms and ranges at Fort Ord were used during basic marksmanship training without modification. Sketches of ranges used for transition training appear in Section IV.

**Table 2-4  
BASIC MARKSMANSHIP  
AUTOMATIC RIFLE INSTRUCTION**

Subject	Total Hours	Ammunition per Firer
Orientation and Mechanical Training	2	0
Target Detection	2	0
Preparatory Marksmanship (25 meter firing)	12	236
Record Practice (Instructional Firing)	4	79
Record Practice (Qualification Firing)	4	74
Night Firing	5	104
<b>Total</b>	<b>29</b>	<b>493</b>

**NOTE:** Modifications to Army Subject Schedule 7-111: Mechanical Training was given to familiarize firers with new weapon systems; refresher training in Target Detection and Night Firing was given because these areas are covered in Basic Rifle Marksmanship Training of which this training is normally a part.

**Table 2-5  
BASIC MARKSMANSHIP  
MACHINEGUN INSTRUCTION**

Subject	Total Hours	Ammunition per Firer
Orientation and Mechanical Training	3	0
Bipod Firing (Table I)	4	42
Tripod Firing, Practice (Table II)	4	108
Tripod Firing, Record Practice (Table III)	4	78
Tripod Firing, Record (Table IV)	4	108
Transition Firing, Practice & Record (Table V)	8	396
Day Defensive Field Firing (Table VI)	7	200
<b>Total</b>	<b>34</b>	<b>932</b>

**NOTE:** Modifications to Army Subject Schedule 7-111: Mechanical Training was increased from 2 to 3 hours; Table VII (Assault Firing) and Table VIII (Day and Night Predetermined Firing) were deleted as not pertinent to the SAWS Experiment.

**Table 2-6  
TRANSITION TRAINING**

Subject	Total Hours	Ammunition * per Firer	
		Rifles	ARs
<b>Rifle Squad</b>			
Orientation	4	0	0
Squad Technique of Fire	4	20	40
Squad in the Approach to Contact	8	60	120
Squad in the Assault	4	100	260
Squad in the Defense	4	60	100
<b>Total</b>	<b>24</b>	<b>240</b>	<b>520</b>

Subject	Total Hours	Ammunition* per Firer
<b>Machinegun Squad</b>		
Support of Attack and Assault Firing	5	700
Defense Firing	3	200
<b>Total</b>	<b>8</b>	<b>900</b>

\* Indicates amount of ammunition allocated for the exercise, not necessarily amount expended which varied from firer to firer.

Table 2-7  
PERSONNEL TRAINED AND CROSS-TRAINED

Type Training	Personnel Trained (Initial Weapon) Training Course	Personnel Not Completing Training	M14 Riflemen Retrained		Stoner Riflemen Retrained	RPD MG Personnel Retrained	M60 Ammunition Bearers	Stoner Riflemen	MG Refamiliarization	Stoner MG Retrained in AR Role
			Completed Training	Did Not Complete Training						
<u>Riflemen</u>										
M14	184	9 <sup>A</sup>								
M14E2 (rifle role)	71	5 <sup>A</sup>								
Colt	128	3 <sup>A</sup>								
Stoner	128	12 <sup>A</sup>			8					
AK47	100	1 <sup>A</sup>								
<u>Automatic Riflemen</u>										
M14E2	16									11
Colt AR	16							4		
Stoner AR	16									
M60 MG (AR role)	16									
Stoner MG (AR role)	16									
RPD MG (AR role)	16									
<u>Machinemen</u>										
M60 (bipod)	46 <sup>C, D</sup>		24 <sup>B</sup>				3 <sup>C</sup>		12	
M60 (tripod)	40 <sup>E (F), G</sup>	1 <sup>A</sup>	24 <sup>B</sup>	1 <sup>A</sup>			(3) <sup>C</sup>		10	
Stoner (bipod)	40 <sup>C</sup>					24			10	16
Stoner (tripod)	37 <sup>C</sup>					23			14	
RPD (bipod)	15	15 <sup>B</sup>							13	
DPM (bipod with tripod group)	34 [14] <sup>B</sup>								8	
<b>TOTALS</b>	<b>975</b>	<b>46</b>	<b>48</b>	<b>1</b>	<b>47</b>	<b>6</b>	<b>3</b>	<b>4</b>	<b>66</b>	<b>29</b>

<sup>A</sup> Figures include personnel who were not sufficiently trained to be used in field experimentation because of PCS, death, hospitalization, AWOL, confinement, or emergency leave.

<sup>B</sup> Personnel did not complete original training because of ammunition shortages, but 14 completed training at a later date.

<sup>C</sup> Received both bipod and tripod training.

<sup>D</sup> To be used as ammunition bearers.

<sup>E</sup> Indicates same personnel as shown in column above marked with <sup>C</sup>.

[ ] indicates footnote applies to number within.

**e. Training Data Collected**

The following types of data were collected during training:

- 1) Timed disassembly and assembly of weapons
- 2) Hits on targets
- 3) Size and type of shot groups
- 4) Number of targets engaged and number hit
- 5) Round dispersion
- 6) Ammunition expenditure
- 7) Number and type of malfunctions
- 8) Individual qualification

The primary measures of training performance were the firing scores taken on various ranges at fixed points during training. Each time firing scores were taken, each weapon system group had had the same amount of training of the same kind under comparable conditions. Results of the training program and firing scores are given in Section IV (Training Results).

**E. EXPERIMENTATION PROCEDURES**

**1. Uniform Operational Policies - General**

Uniform operational policies established for each tactical situation included policies for the situation and for each type of weapon in each mix of each family. These policies governed the ammunition basic load, the burst length (for example, semiautomatic or two round), the ammunition mix (such as the ratio of ball to tracer), the firing position (shoulder pointed, for example), the type of support (with or without sling or bipod), and the type of weapon zero and sight setting. In addition, a standard policy was used for assigning sectors of fire and for assigning weapons to foxholes and to positions in moving formations. These policies and firing techniques were derived from standard doctrine and, where doctrine was not specific, from exploratory firing. They are tabulated by situation in Annex A.

**2. Control and Balance of Weapon Mix Structure and Equipment**

As discussed in paragraph D-3, firers assigned to each mix of weapons were matched, as far as possible. They were also matched in assignments to the weapon types in a mix. When tracers were used by only a portion of a mix (for example, automatic rifles) they were also used by the firers in corresponding positions in all other mixes. This ensured that differences in the mixes would be a function of weapon

differences, rather than tracer rounds employed.

The schedule of runs was equally balanced in a matrix, providing for randomizing and balancing out the effects of extraneous variables (paragraph E-3 of Section I).

When not in use, experimentation weapons were held in guarded vans, and periods of care and cleaning were supervised.

### 3. Modes of Fire

Doctrine and exploratory firing indicated that the best mode of fire for the M14 rifle was semiautomatic fire in all situations. Since the limited time available for the experiment did not permit use of more than one technique of fire for each weapon in each tactical situation, the M14 rifle was fired semiautomatically and the other candidate rifles were, with several exceptions, fired in two round bursts.\* Exceptions were the defense situations (Situations 7 and 8), where time permitted comparison of all rifles in both automatic and semiautomatic fire. Another exception was the base of fire situation in the attack against delaying action (Situation 5), where all rifles fired only semiautomatically. Automatic rifles and machineguns were fired, respectively, in identical burst lengths in each tactical situation.

### 4. Control for Differences in Firer Location and Opportunity

The effects of such differences in firer opportunity as intervisibility were controlled, as far as possible. The squad leader and the same special weapons (such as automatic rifles) were always assigned to the same foxholes or positions. The other firers were assigned from right to left in the descending order of their training phase marksmanship scores.

### 5. Control of Squad Leader Variability

Squad leaders exercised administrative control over experimentation squad except during actual experimentation runs. The effects of the variability of squad leaders was controlled by using standardized, firing policies and eliminating the free play of squad leaders' opportunities.

### 6. Control for Effects of Learning

To minimize transference effects between weapons and other undesirable learning effects, each squad was trained only in the weapons of its specific weapon mix, and each squad fired each situation only once.

\* As a rifle, the M14E2 was fired in two-round bursts because the directive required that it be fired automatically. The AK47 was fired semiautomatically in Situations 1, 2, 4, 5, and in the second series for Situations 7 and 8.

Measures were taken to ensure that the experimentation subjects would not see the tactical situations before firing them. Steps were also taken to ensure that experimentation personnel had equal access to their assigned experimentation weapons during the experiment. When not in use, the experimentation weapons were held in guarded vans. During the experiment, experimentation subjects were also denied access to their TO&E weapons. However, the experimentation subjects, all soldiers of the 194th Armored Brigade had previously been trained in the M14 rifle. Some had also been trained in the M14E2 automatic rifle and M60 machinegun. This bias in favor of the US 7.62mm system was not desirable, but could not be avoided because only previously trained soldiers were available for use as experimentation subjects.

**7. Data Collection Procedures - Primary Measures**

**a. Primary Measures Data**

Most of the SAWS data were provided as output from the SDS 910 computer located on each range in the form of magnetic tapes. These data included hits, near misses, and rounds fired as a function of time.

To ensure the proper collection of valid data, a range officer, an operations analyst, (range scientist), an instrumentations maintenance officer, and a field engineer were always present at each range. In addition, test firing was also done on a regular basis for the purpose of exercising, adjusting, and calibrating the instrumentation before and during the experiment.

**b. Supplementary Data**

In addition to the data collected by instrumentation, meteorological data were taken continuously at each range. Reliability data were gathered during each squad trial. Target instrumentation calibration was checked between each squad trial and the results recorded. This included a manual count of hits on targets and near miss sensor panels, and a count of remaining ammunition.

**8. Administrative Procedures**

**a. Briefings and Debriefings**

Squads were given identical administrative and semitactical briefings on each range immediately before firing, and were debriefed for information about weapon malfunctions immediately after firing.



#### b. Safety Procedures

Because of the scale and nature of the experiment, special safety measures were necessary to reduce the possibilities of accidents, without detracting from the essential realism or validity of the experiment. Among the safety measures used were briefings on scale models and actual terrain immediately before firing with respect to safety limits, the use of specially trained controller teams at each firing line and in each moving firing situation, provision of cook-off pits for safe disposition of jammed hot weapons, and procedures for clearing hot weapons after a trial by shooting off the last round. Moving pictures were taken of controllers and firers during each squad run. These were shown later for study and correction of safety procedures and weapons malfunctions.

#### F. EXPERIMENTATION TACTICAL SITUATIONS

Experimentation was based on nine tactical squad firing situations grouped three to a range. The three situations on each range were inter-related parts of a platoon and company framework situation but fired separately for reasons of data collection and safety. The three platoon-company framework situations selected were:

- 1) Assault against defense (Range A)
- 2) Attack against delaying action (Range B)
- 3) Defense against attack (Range C)

These three platoon-company framework situations were constructed to ensure that squad situations could be related for analysis and synthesis (especially later for IRUS purposes) and to provide for the measurement of representative mechanisms and modes of fire of small unit small arms combat.

Each tactical situation constituted a model consisting of selected terrain characteristics, target array layouts, friendly firer layouts, firing distances and range-target frequencies, and timing of events representative of the situation being portrayed. (See Annex B for range sketch maps and detailed range information, to include Target System Command Program Tables.) These tactical situations, together with the effectiveness criteria, provide the fundamental basis for the analysis. The component situations and their effectiveness values can be weighted, if desired, to modify the basic model, within limits.

The target layouts were determined by examining the dispositions and dimensions given in US, Soviet, and other doctrine and, where possible, adopting dimensions that were common to the several doctrines. Detailed intervisibility and survey data were collected during layout of the ranges. As far as possible, such target behaviors as type of individual target body,

up and down movement, target exposure times, and weapon simulator cues were based on tactical realism.

The firing distances used in the tactical situations were chosen to represent the frequent and useful ranges of small arms combat with additional longer range increments added for purposes of securing a broader data base. The maximum range fired by rifle squads was 560 meters and the maximum for machineguns was 753 meters. \* Safety considerations and available terrain did not have an important effect on the firing distances selected. The percentages of targets by range for the nine tactical situations are shown below:

Range (Meters)	Percentage of Targets <sup>a</sup>	
	Rifle Squad	MG Squad
0-50	15	2
51-150	35 <sup>b</sup>	11
151-250	10	8
251-350	16	17
351-500	16	29
500-650	8	21
651-750	0	12

<sup>a</sup> Includes targets used in the night situation and targets presented more than once in a given situation

<sup>b</sup> Includes targets on assault course that ranged from 148 to 15 meters

The nine squad situations consisted of six rifle squad situations and three machinegun squad situations. Of the six rifle squad situations, two involved moving firing and one involved a night firing situation. The nine situations are tabulated below and described in the following paragraphs.

\* Preliminary experimentation on Range B (Situations 5 and 6) showed that firers could distinguish neither targets nor target array locations at these longer ranges, even when provided with more substantive auditory cues and visual cues than they would have in combat. This was true, even though individual targets had camouflaged semicircular near miss panels 4 meters in diameter behind them. The squads were therefore provided additional specific intelligence of the target array locations so that firing data could be collected at these ranges.

<u>Assault Against Defense (Range A)</u>	<u>Attack Against Delaying Action (Range B)</u>	<u>Defense Against Attack (Range C)</u>
1. Rifle squad in line assault	4. Rifle squad in approach to contact	7. Rifle squad in defense against attack
2. Rifle squad as base of fire supporting the assault	5. Rifle squad as a base of fire supporting the advance	8. Rifle squad in night defense against attack
3. Machinegun squad in fire support of the assault	6. Machinegun squad in fire support of advance*	9. Machinegun squad in defense against attack

1. Situation 1: Rifle Squad in Line Assault

Situation 1, focusing on the left target array on Range A (Figure 2-9), represented a 100-meter assault by a squad in line formation. The action lasted 2 minutes. The assaulting troops employed marching fire as they moved up the slope. Firing commenced 115 meters from the nearest target and ceased 15 meters from it. The target array being assaulted occupied a position 50 meters wide and 30 meters deep with the elevation rising 4 meters from the front to rear on the same slope as the assaulting troops. The array consisted of 17 head and shoulders targets representing concealed and partially concealed dug-in enemy soldiers, as a squad with other company elements as part of a reinforced rifle company in defense. Although irregular, the lateral interval between targets averaged 6 meters. Each target in the array had an acoustic near miss sensor, and all but three had weapons simulators.

Situation 1 evaluated rifle squad weapons mixes in marching fire against targets in foxholes at ranges of 148 to 15 meters.

2. Situation 2: Rifle Squad as a Base of Fire Supporting the Assault

This situation was also located on Range A (Figure 2-10). In addition to the target array used in the assault situation, this situation included an additional array to the right. The right array contained 13 head and shoulders targets (a squad with other company elements) occupying a position 50 meters wide and 35 meters deep with elevation rising 4 meters.

\* Machinegun squads fired this situation from two different positions. In follow-on experimentation in January, the machinegun squads fired from the same positions used by the rifle squad in Situation 5.

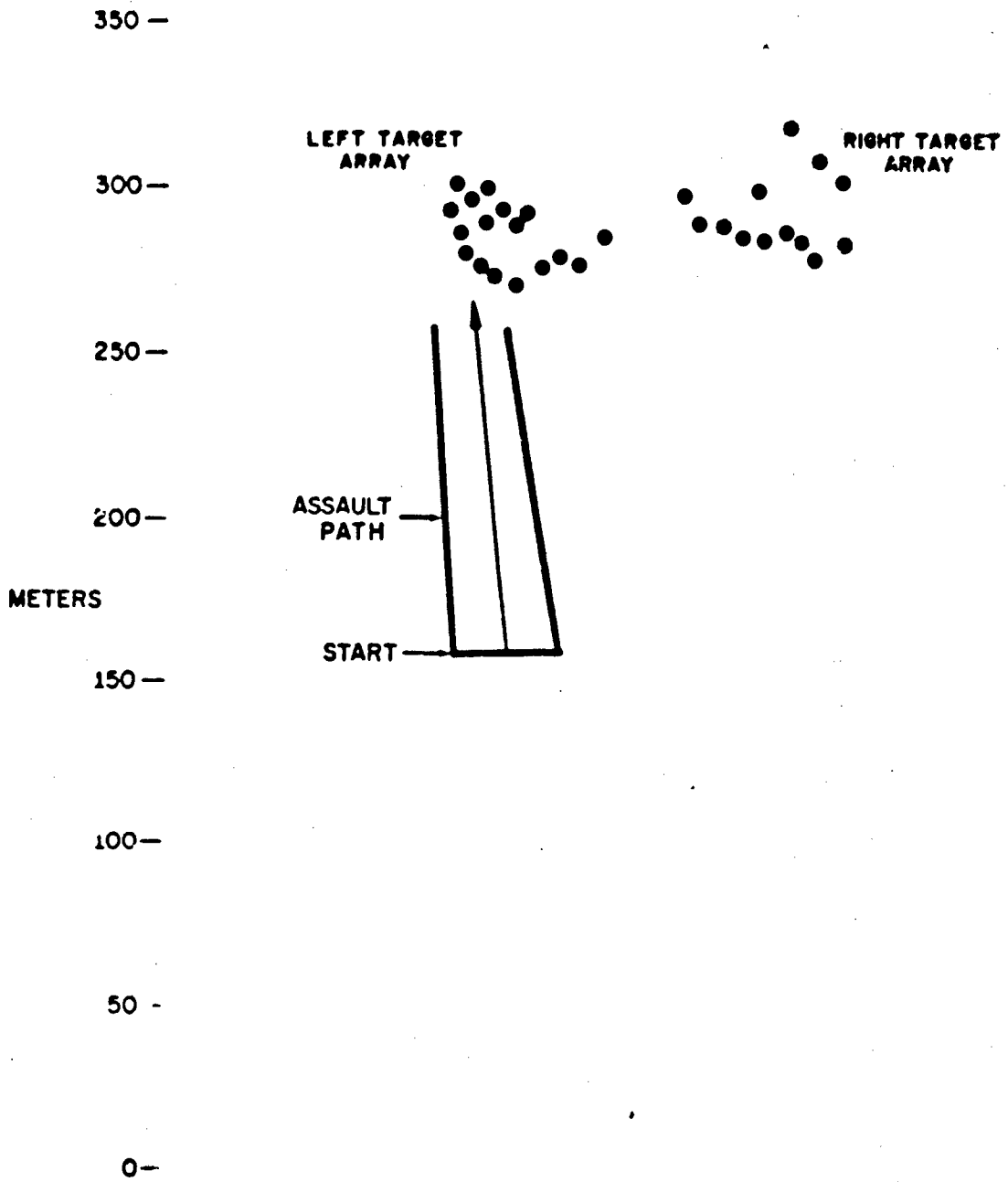

Figure 2-9  
SITUATION 1, RANGE A

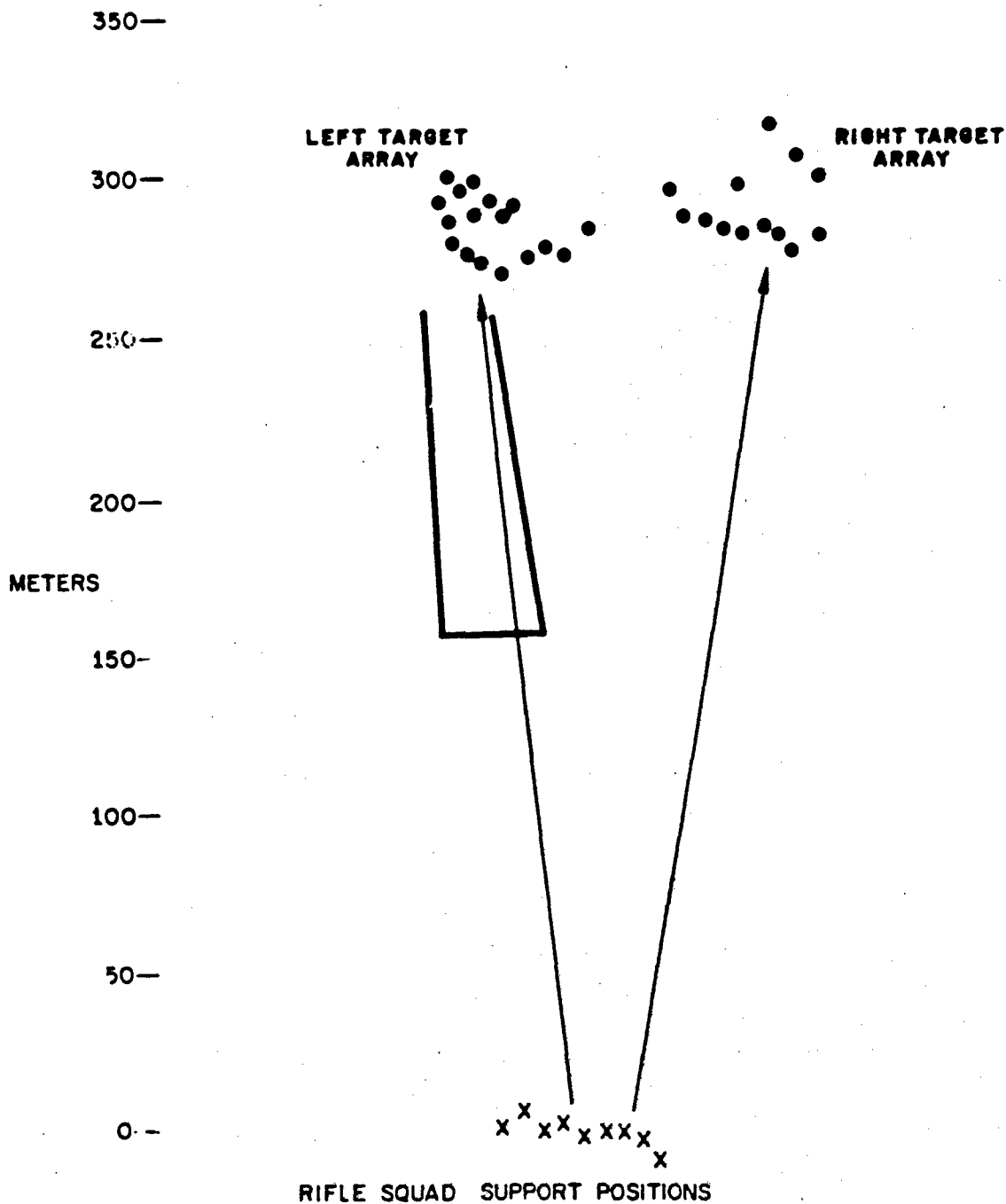

Figure 2-10  
SITUATION 2, RANGE A

from the front to the rear. All but two of the targets were equipped with weapons simulators, and all had acoustic near miss sensors.

The firers were located in nine shallow foxholes, laterally about 6 meters apart and staggered in depth along the forward edge of a ridge. The foxholes represented typical hastily prepared individual battlefield positions. The squad fired first on the left target array (the array used in Situation 1) and then shifted its fire to the right target array to simulate the shifting of fire as the assault troops closed on the enemy. The distances from the firers to the two target arrays was from 263 to 326 meters.

Situation 2 evaluated rifle squad weapon mixes firing supporting fire from hastily prepared foxholes at concealed and unconcealed targets in foxholes at a range of 263 to 326 meters.

3. Situation 3: Machinegun Squad in Fire Support of the Assault

This situation utilized the same terrain, targets and firing positions as that used by the rifle squad in Situation 2. However, this situation depicted a machinegun squad in support of a rifle squad in the assault. The two machineguns of the squad were positioned 25 meters apart (Figure 2-11).

4. Situation 4: Rifle Squad in Approach to Contact

This situation, located on Range B (Figure 2-12), included 12 events and employed 40 targets (four head and shoulders, 32 kneeling and four standing). The 12 events were laid out along a course over which the rifle squad advanced in a sweep formation as a line of skirmishers. The events represented action by snipers, scattered enemy security elements, and an ambush. The overall course was 430 meters long (Figure 2-13).

As the squad approached an event at a location identical for each squad, the targets--30 equipped with weapons simulators--were actuated and the men stopped and fired. The firing distances for the events varied from 19 to 180 meters. Target exposure times varied from 2 to 10 seconds. The targets were not equipped with near miss sensors.

The approach to contact situation evaluated the rifle squad mixes in standing quickfire at briefly exposed visible targets. This situation, in which firers were time stressed, was designed especially to evaluate the pointing characteristics of small arms.

5. Situation 5: Rifle Squad as a Base of Fire Supporting the Advance

The rifle squad occupied unprepared prone firing positions averaging 6 meters lateral distance apart and staggered 48 meters along the forward edge of a ridge (Figure 2-14). Squads representing fire support of an advancing rifle squad (Situation 4) delivered fire on two target arrays. The

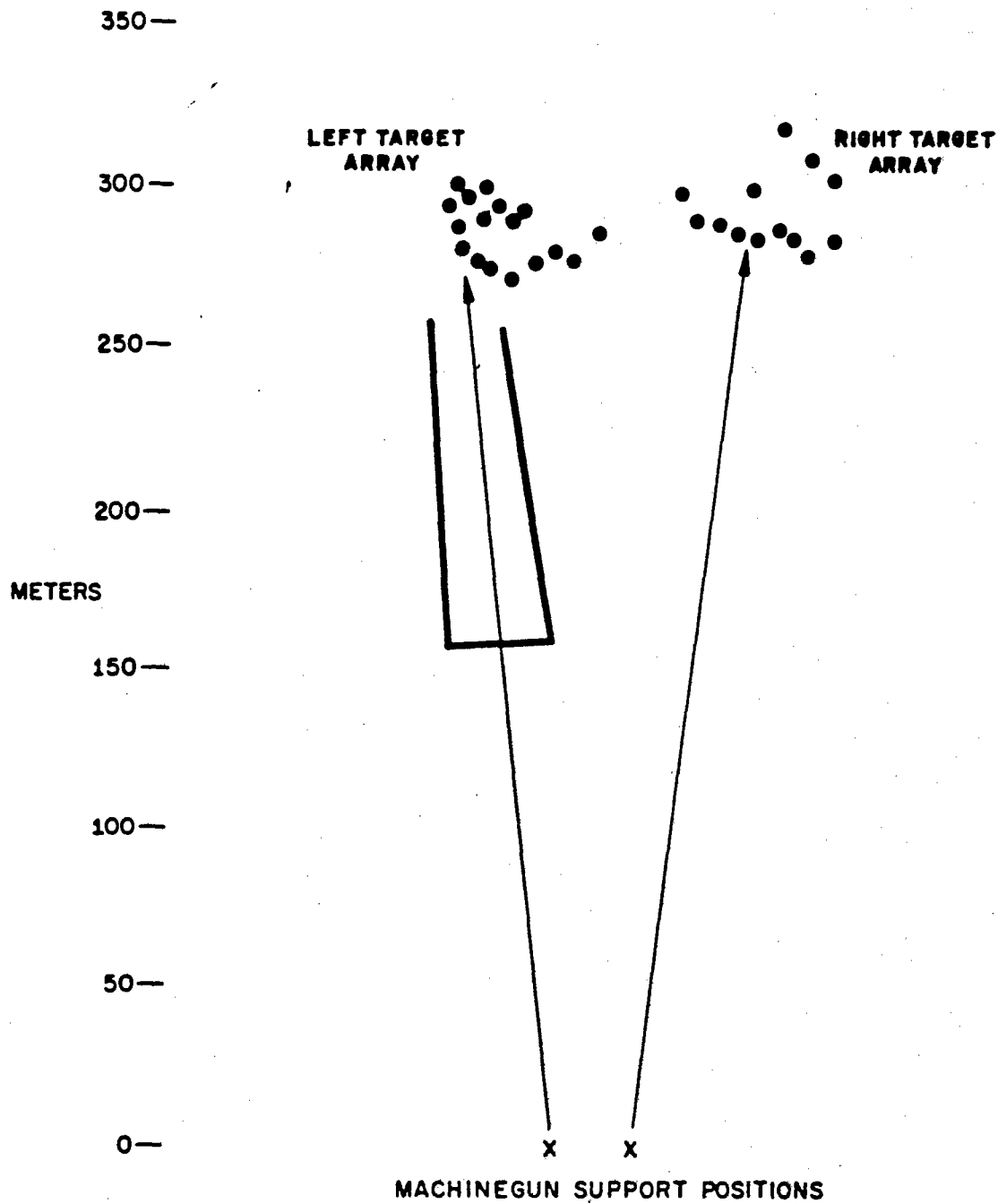

Figure 2-11  
SITUATION 3, RANGE A

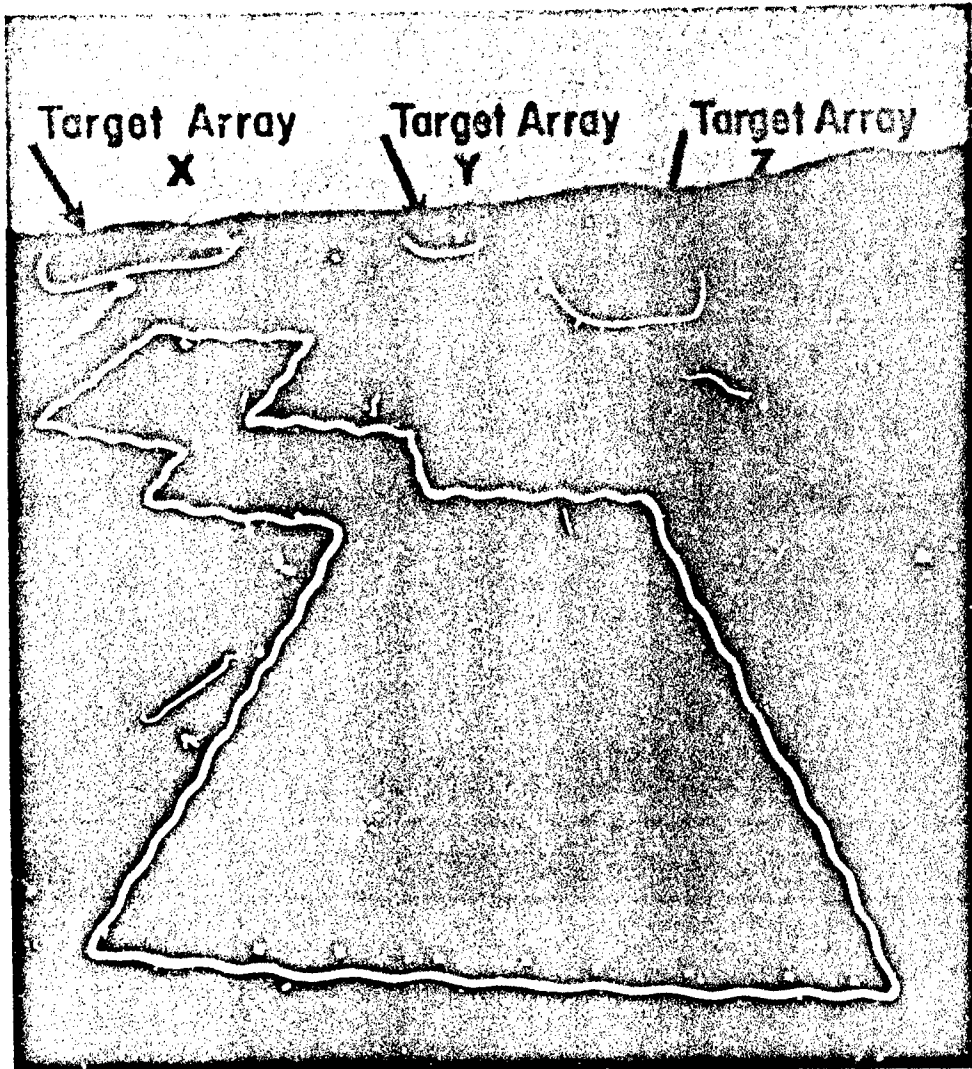

Figure 2-12  
SITUATION 4, APPROACH TO CONTACT, RANGE B



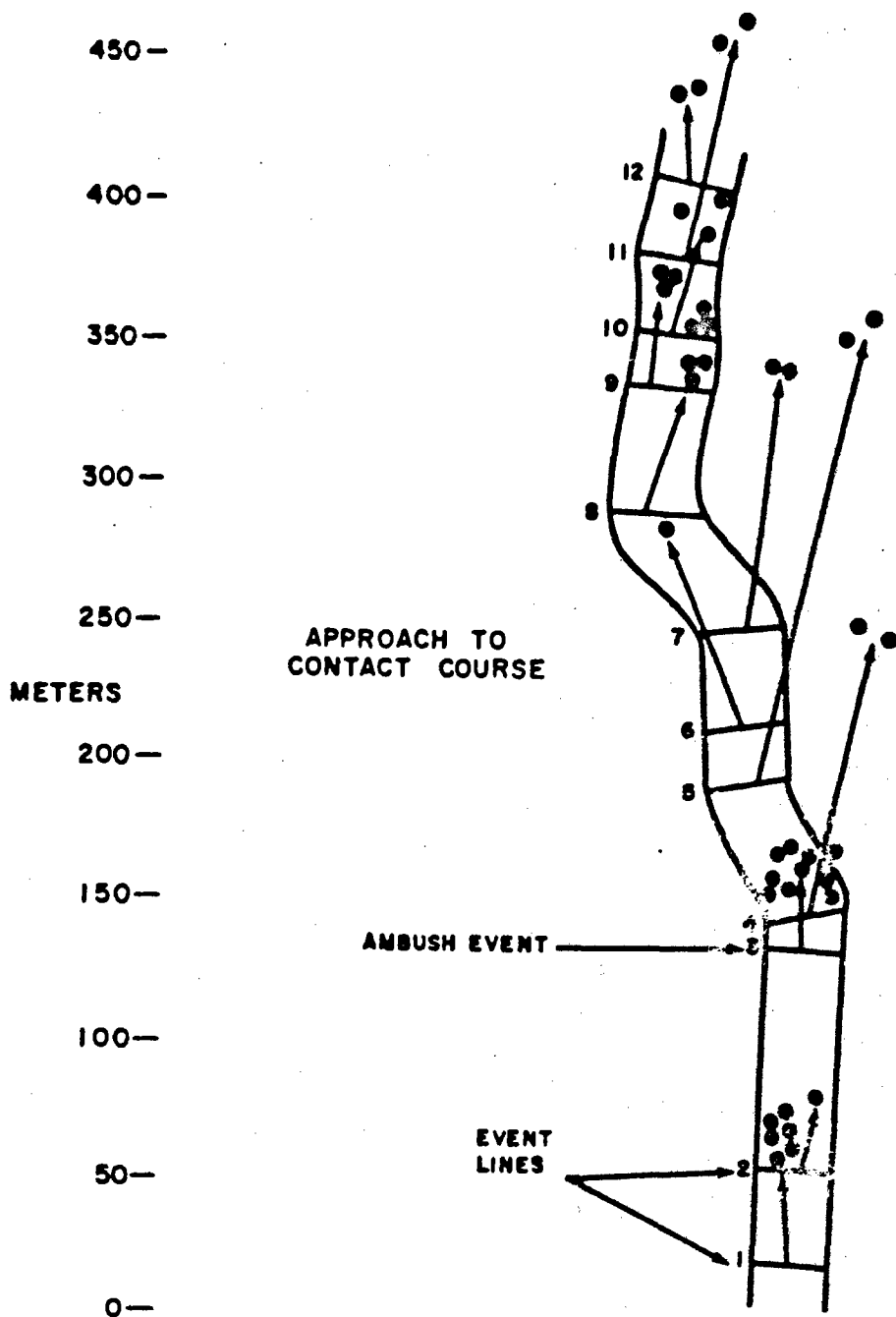

Figure 2-13  
SITUATION 4, RANGE B

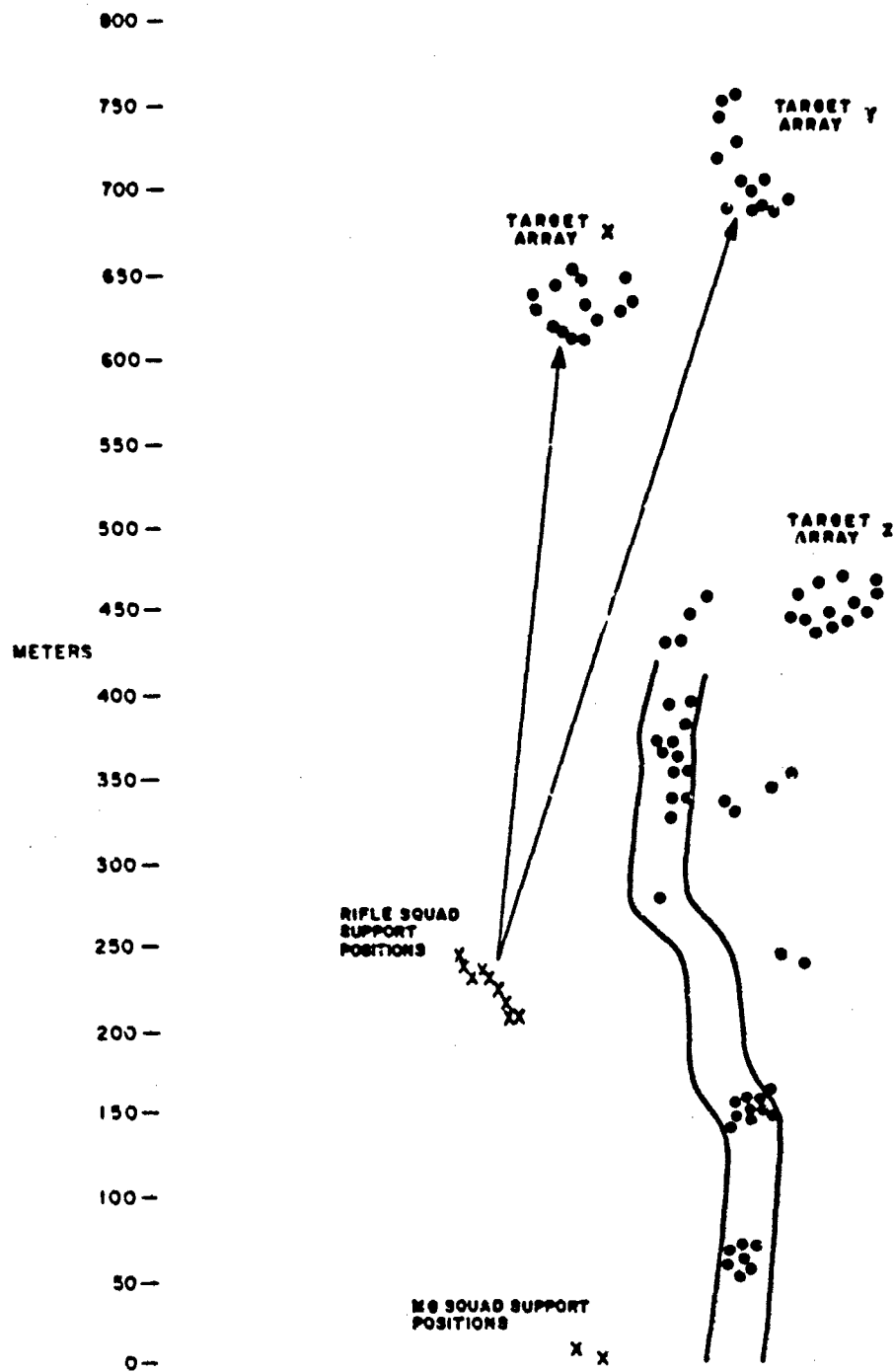

Figure 2-14  
SITUATION 5, RANGE B

arrays represented partially dug-in enemy in a delaying position. Target Array X contained 14 targets (five head and shoulders and nine kneeling) occupying an area 60 meters wide and 42 meters deep, with an elevation from front to rear targets of about 7 meters. Its range from the firers was 379 to 445 meters. Six of the 14 target elements in this array had weapon simulators. The more distant Target Array Y with three head and shoulders, three kneeling and seven standing targets, was 477 to 560 meters from the firers, occupying an area 45 meters wide and 62 meters deep with elevations rising about 7 meters. Six of the 13 targets had weapon simulators. The targets of both arrays were equipped with near miss sensors. The rifle squad initially fired on Target Array X and then shifted its fire to Array Y, firing 2 minutes on each array.

Situation 5 evaluated rifle squad weapons mixes delivering long range supporting fire from prone positions against concealed partially dug-in targets at ranges of 379 to 560 meters.

6. Situation 6: Machinegun Squad in Fire Support of Advance

This situation was also on Range B (Figure 2-15). Machineguns of the machinegun squad weapon mixes occupied positions about 12 meters apart along the forward edge of a knoll 240 meters to the rear of the rifle squad position of Situation 5. In addition to firing upon Target Arrays X and Y discussed in Situation 5, Target Array Z was also fired upon and contained 13 targets occupying an area 52 meters wide and 32 meters deep, with an elevation from front to rear targets of about 7 meters. Like Arrays X and Y, all targets of this array had near miss sensors and six were equipped with weapons simulators. Target Array Z was located to the right of Target Arrays X and Y at a shorter range and contained five head and shoulders and eight kneeling targets. Ranges to the three target arrays from the machinegun squad position were 603 to 646 meters for Array X, 690 to 753 meters for Array Y, and 446 to 488 meters for Array Z. Firing time was 2 minutes on each array.

Situation 6 evaluated the machinegun squad weapon mixes in firing long range supporting fire from prone positions at concealed and partially concealed, partially dug-in targets at ranges from 446 to 753 meters. It was designed to evaluate long-range fire effectiveness of the weapons under tactical conditions.

7. Situation 7: Rifle Squad in Defense Against Attack

This situation took place on Range C (Figure 2-16). There were 50 targets, four head and shoulders, 17 kneeling and 29 standing, located and programmed to raise and lower to represent an attack becoming an assault. Some of the targets appeared more than once. The attack began at a range of 344 meters and culminated with targets appearing in an

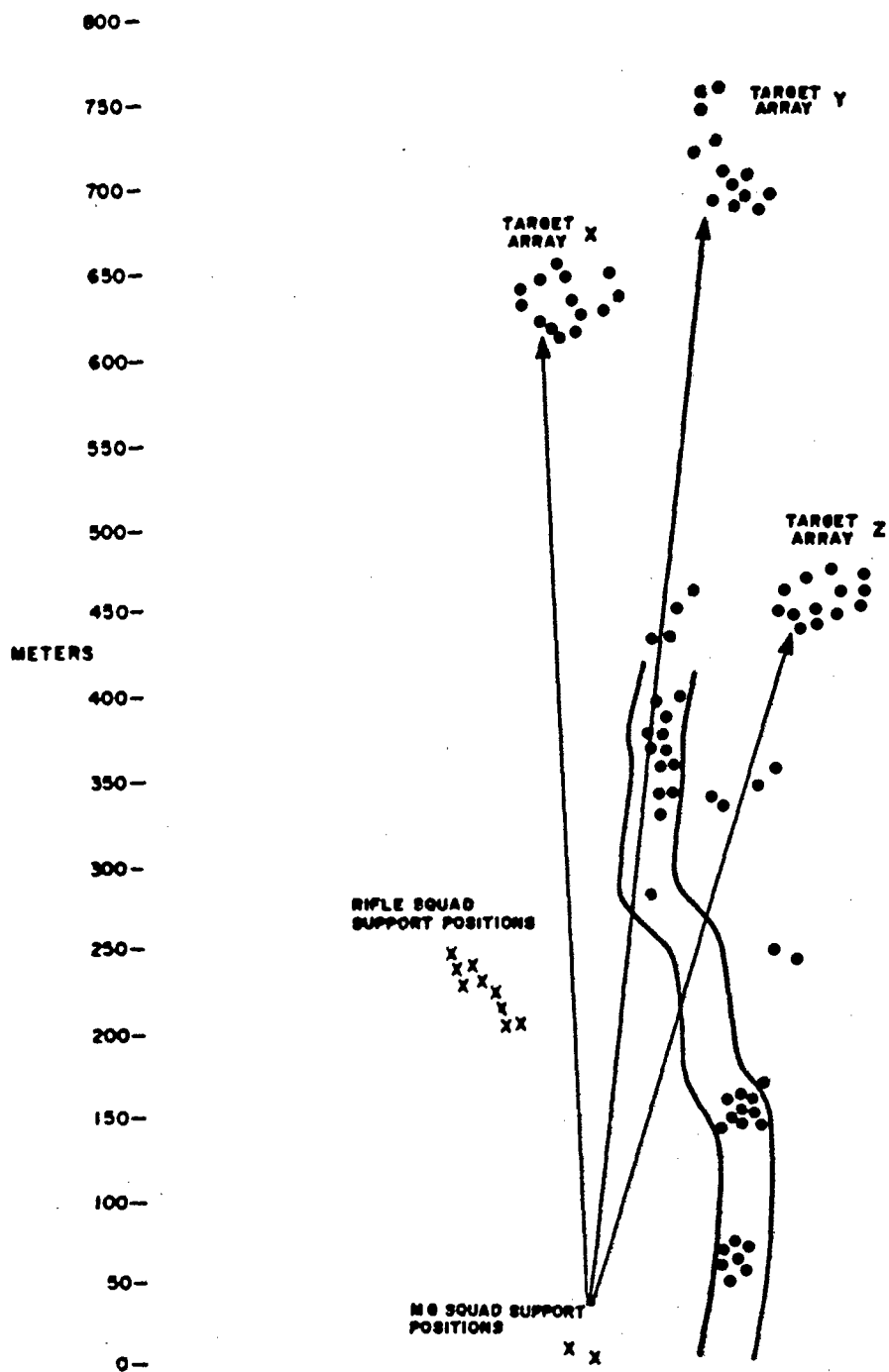

Figure 2-15  
SITUATION 6, RANGE B

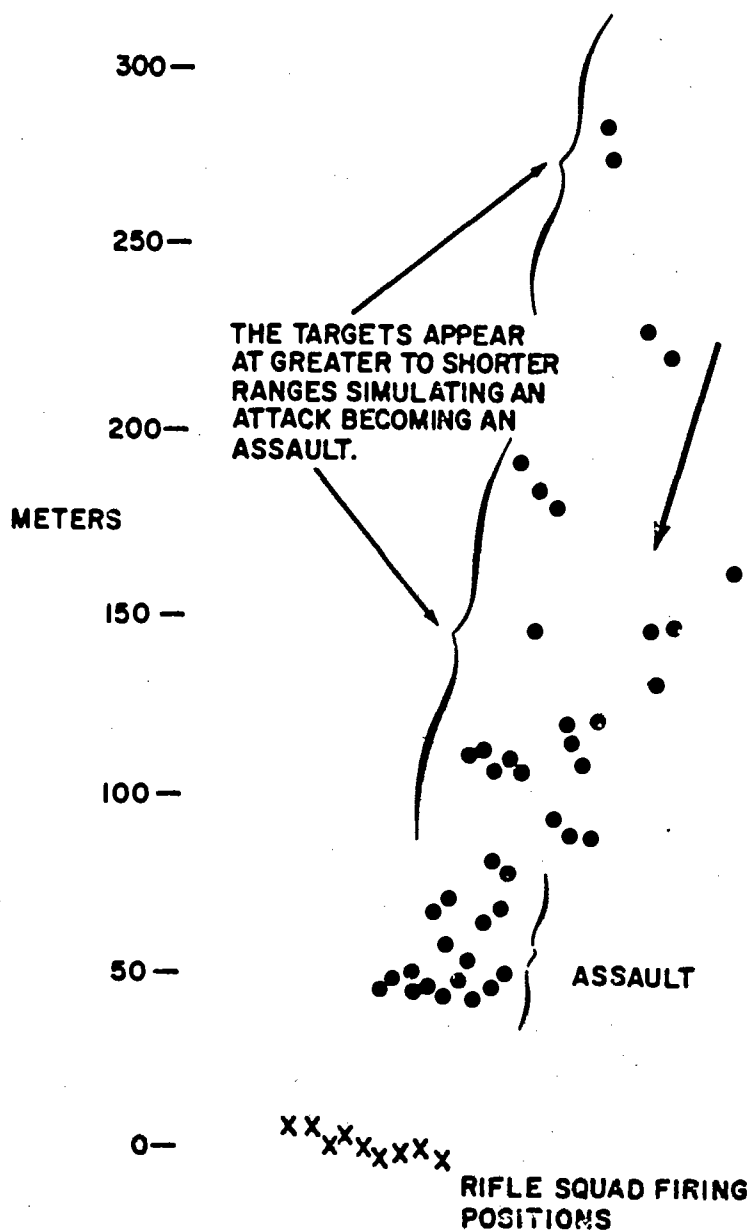

Figure 2-16  
SITUATION 7, RANGE C

assault formation 43 meters from the firing positions. Thirty of the 50 targets had weapon simulators; none had near miss sensors. The defending squad occupied hastily prepared foxholes averaging 6 meters lateral distance apart.

Situation 7 (daylight defense) evaluated rifle squad weapons mixes in firing from hastily prepared foxholes at visible targets advancing from 344 to 43 meters.

8. Situation 8: Rifle Squad in Night Defense Against Attack

The night situation was also located on Range C and was similar to Situation 7. However, the scenario was slightly shorter. Thirty-two of the 50 targets used in Situation 7 were utilized; 22 targets were equipped with weapons simulators. Some of the targets appeared more than once. There were three head and shoulders, nine kneeling and 20 standing targets; they were located and programmed to raise and lower to represent an attack becoming an assault. The attack began at a range of 234 meters and culminated with targets appearing in an assault formation 43 meters from the firing position (Figure 2-17). Simulator flash and sound were the main cues for firers in this night situation.

Situation 8 evaluated rifle squad weapons mixes firing night defense from hastily prepared foxholes at target flash and sound cues of targets "advancing" from 234 to 43 meters.

9. Situation 9: Machinegun Squad in Defense Against Attack

This situation utilized the same terrain, targets and firing positions as that used by the rifle squad in day defense (Situation 7). However, in this situation the machineguns occupied selected foxholes of the position that had been occupied by the rifle squad (Figure 2-18).

This situation evaluated the machinegun squad weapon mixes firing from hastily prepared foxholes at visible targets advancing from 344 to 43 meters.

10. Summary of Tactical Situations

The nine tactical situations, together with the effectiveness criteria discussed in paragraph G of this section, provide the model for the experiment and analysis of squad-level small arms fire effectiveness. The model can be adjusted (within limits) by weighting the situations and the effectiveness measures within a situation. The logic underlying the experimental design, terrain selection, tactical target arrays, instrumentation, and programming of events in these tactical situations was to present squads armed with different weapons and weapon mixes with situations

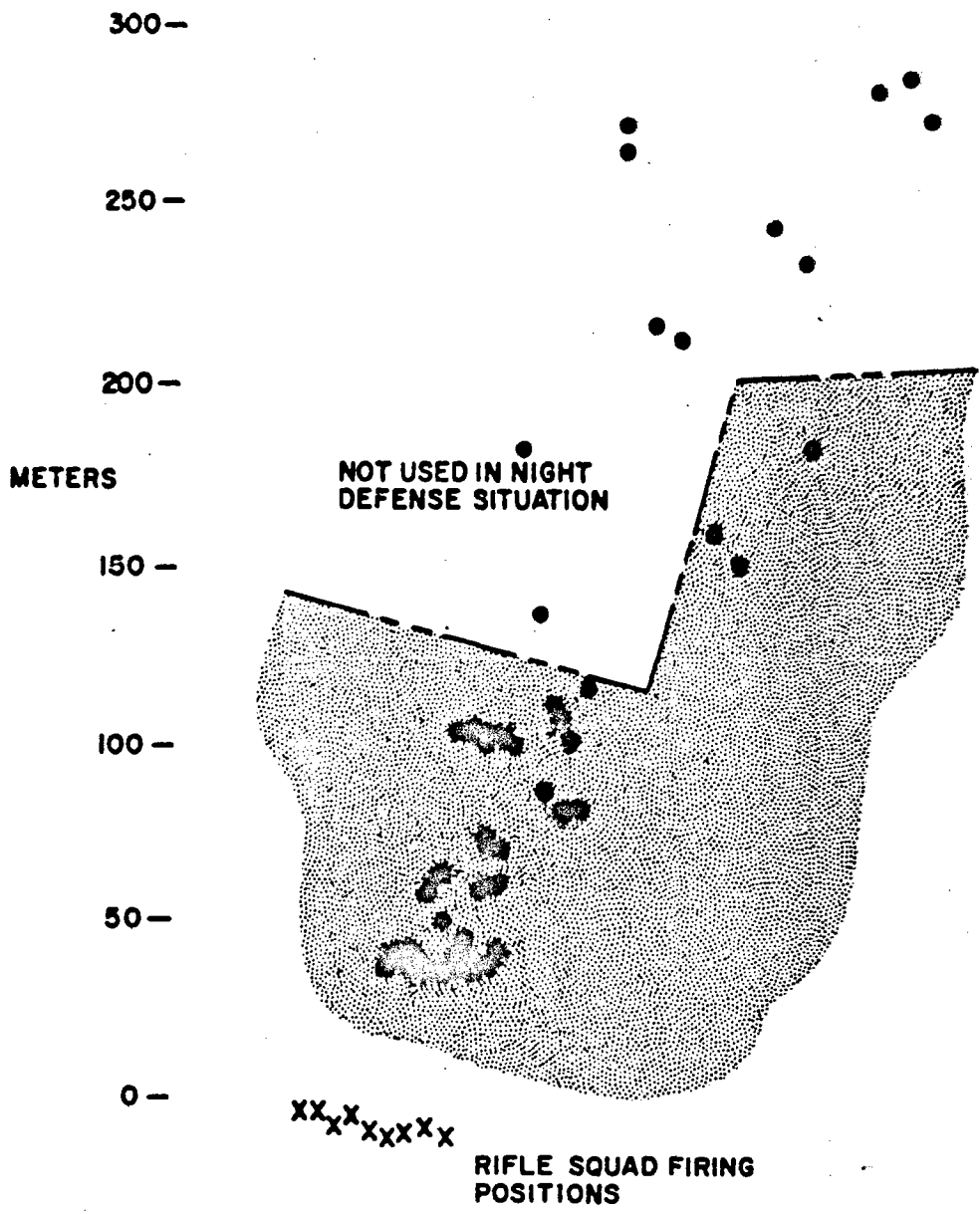

Figure 2-17  
SITUATION 8, RANGE C

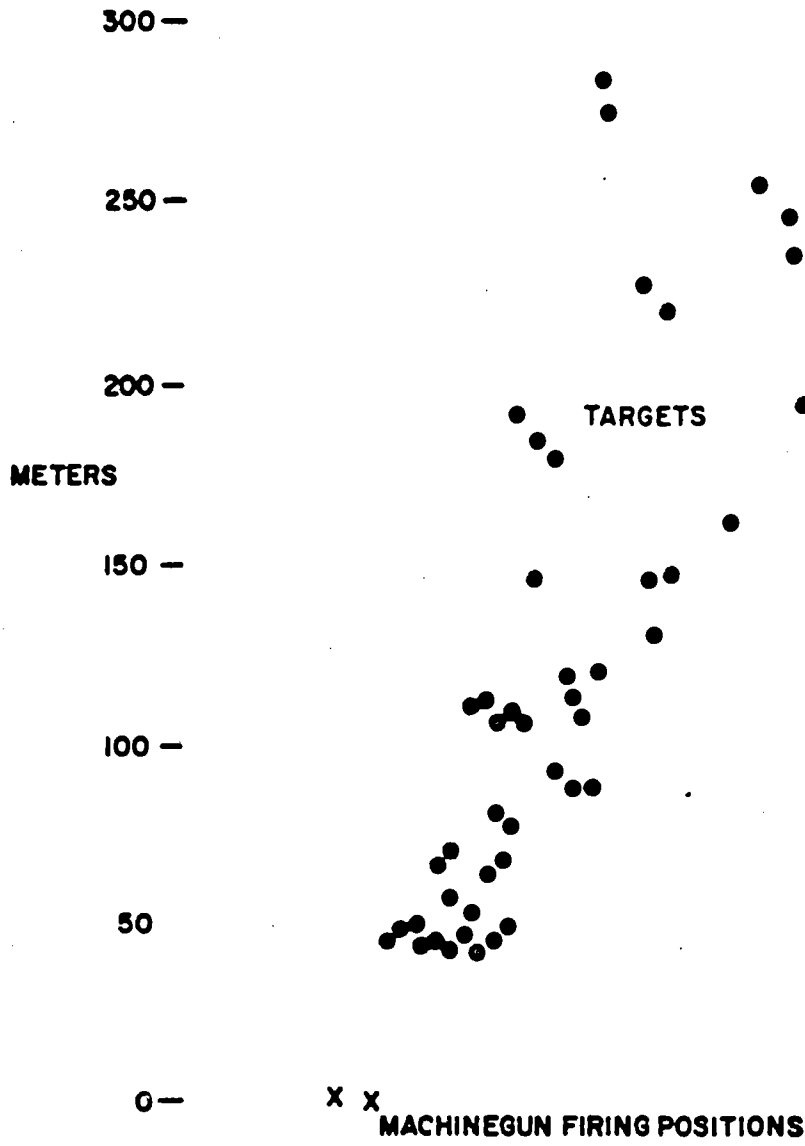

Figure 2-18  
SITUATION 9, RANGE C



that would impose on the man-weapon systems, conditions, interactions, and modes of fire reasonably representative of combat. Target acquisition was included as an integrated part of the effectiveness evaluation of the man-weapon systems. Firers were subjected to the stress and uncertainties of intervisibility problems and the knowledge that, if and when revealed, targets would be fleeting or exposed for unpredictable periods. However, stress was not otherwise included.

The final elements of the tactical situations were the operational policies of friendly elements--the basic loads of ammunition, ammunition mixes, burst lengths, and firing policies used with each tactical situation. These are discussed in paragraph E of this section and presented in tabular form in Annex A.

#### G. EFFECTIVENESS MEASURES (EVALUATION CRITERIA)

This subsection describes the effectiveness measures used in evaluating and ranking the squad weapon mixes. It consists of three paragraphs: Paragraph 1, discussing the qualitative effectiveness concept from which the measures are derived; Paragraph 2, presenting the effectiveness measures themselves; and Paragraph 3, discussing other effectiveness qualities.

##### 1. Effectiveness Concept

The effectiveness measures selected for use in the experiment were derived from the following qualitative effectiveness concept, which also served to guide their use. This concept is necessarily judgmental as a hypothesis, as must be the starting point and foundation of any effectiveness criteria. It also depends particularly on informed military judgment or military experience, since system evaluation implies that the things measured must be valuable qualities of the systems, in the context and environment of their use.

The purpose of the infantry fire fight is to gain fire superiority. Other factors being equal, small arms fire superiority prevents the enemy's fire or movement, permitting mission accomplishment.

Achievement of fire superiority requires two elements: 1) attaining a greater magnitude of target effects than the enemy, as a function of time, and 2) sustaining this level of target effects longer than the enemy can sustain his level of target effects, and long enough to accomplish the mission. These two elements are referred to here as target effects and sustainability.

Neither element is meaningful unless related to time. The two-sided nature of the fire fight places a premium on achieving results (target

effects) more quickly than the opponent can achieve them. The concept of sustainability also implies time.

**a. Target Effects**

To understand target effects, the nature of the target and the friendly firers must be considered.

In combat, the infantry small arms target is normally a group target--an array of individual targets dispersed in width, depth, and usually height. The target arrays frequently present a pattern in shape, structure, and size. Normally most of the targets in the array are concealed or partially concealed, and firing on the array is often directed at a combination of cues--such as terrain form (for example, the military crest of a hill), and target weapon signatures--and movement, rather than at fully visible individual human targets. When targets are not concealed, they are usually very near or exposed only briefly.

Friendly firers are also a group (in this experiment, a squad) and behave in a group context. The individual man-weapon interacts with others in the group at the firing position (for example, muzzle blast and dust), in feedback of target intelligence (for example, incidental observation of another's tracer or of the ground strike of another's bullets), and in effects on the enemy target array.

Thus, the fire effects produced have characteristics that may differ significantly from those of single weapons fired at single visible targets. Within this context of group firers and group targets, the two principal target effects produced by small arms weapons are hits and near misses, and they combine in their effects on a target array.

**(1) Target Hits**

The effects of hits on individual targets of an array are highly sensitive to the timing of the hits and to the damage they inflict on the array. First hits on individual targets are more important than subsequent hits on the same target. In combat the target may drop and cease to be a target after the first hit and, in any event, there is little utility in killing a target more than once.

**(2) Near Misses**

If near enough and in sufficient volume, near misses cause the target soldier to seek cover and thereby take his weapon out of action or prevent his movement. Suppressive effects of small arms, particularly automatic or rapidly firing weapons, may have a greater effect on the outcome of infantry actions than the lethal effects of hits. Near misses,

however, will not produce suppression if the weapons and firing doctrine cannot produce casualties. The nearness of a miss as a function of time is only one factor contributing to suppression, but it is a necessary condition if a weapon is to have any suppressive effect. For purposes of ranking weapons, near misses can be dealt with by recording them as a function of time, without having to define the quantitative level of near misses that constitutes suppression.

Near miss data also provides information on distribution of fire. Information on the distribution of fire greatly extends our knowledge of the behavior of weapon systems, and firing doctrine.

**b. Sustainability**

**Sustainability**—the other element needed to achieve fire superiority—is the length of time a weapon can fire at the ammunition consumption rate required to achieve a level of target effects with the amount of ammunition that the weapon system affords within specified weight limits. It is not used in the sense of reliability or durability.

The sustainability element of fire superiority then is the measure of how long the fire (level of target effects) can be kept up. With respect to a single small arms weapon, it is a function of three factors: 1) the weight rate of ammunition consumption in achieving a level of target effects, 2) the system weight of the weapon, and 3) the weight limitation on the weapon system portion of the soldier's combat load carrying capacity. Sustainability in a small arms system is highly sensitive to system weight, since the infantryman is severely weight-limited. System weight limits used for the experiment are discussed on page 2-8.

**c. Interrelationships**

Hits cannot be related to near misses in an absolute sense because of the impossibility of defining the level of near misses constituting suppression for a given situation. However, the relative value of hits or near misses as a measure can be obvious for a given situation. There are also the possibilities of examining near misses parametrically.

The relationship between sustainability and target effects is clearer. A gain in sustainability potential can be taken out at the unit commander's option as 1) within limits, a higher level of effects, 2) greater sustainability at an equal level of effects, 3) reduced soldier's load at the same level of effects (increase in mobility), or 4) some combination of these.

**2. Measures of Effectiveness**

Based on the qualitative effectiveness concept, three primary measures of effectiveness were selected: cumulative target exposure

time, near misses, and percentage of ammunition remaining (sustainability). In addition, two collateral measures were selected: targets hit and total hits.

**a. Primary Measures of Effectiveness**

**(1) Cumulative Exposure Time**

Each target of an array was programmed to be exposed for a predetermined period that was identical for each squad in a given tactical situation. In the day defense situation, for example, the sum of the programmed exposure times for all the targets of the entire array of 50 targets was 15.976 minutes. However, individual targets fell when hit, reducing their exposure time and thus the total or cumulative exposure time of the array. For programmed total exposure times for each tactical situation, see Appendix 4 to Annex B. In the hypothetical example shown in Table 2-8 there are ten targets in an array with a programmed total exposure time of 12.400 minutes. The sequence of ten targets shows that some targets were raised earlier and stayed up longer than others. The total target exposure time for targets attacked by Squad A is therefore shortened from the programmed 12.400 minutes to 5.700 minutes. This 5.700 minutes total exposure time is the cumulative exposure time (CET) for Squad A. Similarly, Squad B achieves a CET of 8.800 minutes. To the extent that a squad rapidly acquires and hits targets the CET will be less. A lower CET indicates that friendly forces in a fire fight are subjected to fewer man-minutes of return fire from the target array and consequently suffer fewer casualties and other effects. Therefore, the concept takes considerable account of vulnerability.

CET of the target system is a primary measure of fire effectiveness. It reflects both the number of targets in a group that were hit and the timeliness in which they are hit.

**(2) Near Misses**

Near miss data were obtained in three of the six rifle squad situations and two of the three machinegun squad situations. \* Near misses passing within a 2 meter hemisphere about the target were sensed by an acoustic sensor; where camouflaged panel sensors were used (Situations 5 and 6), near misses were sensed by a 2 meter semicircular panel centered behind the target body. In both cases near misses were recorded as a function of time.

\* The rifle squad situations were the assault (Situation 1), base of fire in support of the assault (Situation 2), and base of fire in support of the attack against delaying action (Situation 5). The two machinegun squad situations were those in support of the rifle squad in the assault (Situation 3) and in fire support of the advance (Situation 6).

**Table 2-8  
HYPOTHETICAL EXAMPLE OF  
CUMULATIVE EXPOSURE TIME (CET)**

Target Number	Target Sequence (minutes)		Individual Target Exposure Time (minutes)		
	Programmed Up Time	Programmed Down Time	Programmed <sup>A</sup> Exposure Time	Squad A <sup>B</sup>	Squad B <sup>B</sup>
1	0	1.700	1.700	.500	.300
2	.500	2.000	1.500	.500	1.200
3	.600	2.200	1.600	.700	1.500
4	1.000	2.500	1.500	.600	1.500 <sup>C</sup>
5	1.200	2.000	.800	.800 <sup>C</sup>	.800 <sup>C</sup>
6	1.800	3.000	1.200	.200	1.100
7	2.200	4.000	1.800	1.000	1.000
8	3.500	4.500	1.000	.600	.500
9	4.000	4.300	.300	.300 <sup>C</sup>	.300 <sup>C</sup>
10	4.500	5.500	1.000	.500	.600
Programmed Total Exposure Time (minutes)			12.400		
Cumulative Exposure Time (minutes)				5.700	8.800

<sup>A</sup>Programmed down time minus programmed up time

<sup>B</sup>Hit time minus programmed up time (targets went down when hit)

<sup>C</sup>Target not hit

The measure of near misses used in the present report is total near misses. Near misses are a primary measure because of the importance of suppressive fire effects. However, because of instrumentation procurement limitations near misses could not be measured in all tactical situations.

### (3) Sustainability

The primary determinant of weapon sustainability (in the sense that it is used here) is the length of time that available ammunition can sustain an attained level of effects. The measure of sustainability used here is the percentage of ammunition remaining for a squad mix when the squad weapon system weight constraint (starting system weight), tactical situation, and record run time are held constant for all squad mixes. In Figure 2-19, for example, if Squad Weapon Mix B used 50 percent of its ammunition load to attain a given level of effects, it would have only half the sustainability (ability to maintain the same level of effects longer) of Squad Weapon Mix A that attained the same level of effects with an expenditure of only 25 percent of its ammunition.

#### b. Collateral Measures

Collateral measures, as defined here, are lesser included functions of primary measures and therefore are subordinate to primary measures. They are performance measures, rather than effectiveness measures. However, the collateral measures of the number of targets hit and total number of hits provide some limited insights into weapon system behavior and sometimes facilitate interpretation of the primary measures.

##### (1) Targets Hit

This measure indicates the number of targets hit in a given target system, but gives no indication of the amount of time required to secure the hits. When related to total targets, it provides a measure of fire distribution and some insight into the cumulative exposure time measure. If the same number of targets in an array are hit, but at different times, the cumulative exposure time will be different.

##### (2) Total Hits

This measure takes into account multiple hits on targets. Since targets in this experiment fell on receiving a first hit, multiple hits could occur, as in combat, only because of rapid fire from a single weapon or because two or more firers acquired and hit a target almost simultaneously. The total hit measure has collateral worth as an effectiveness measure, especially if two systems rank equally in other respects.

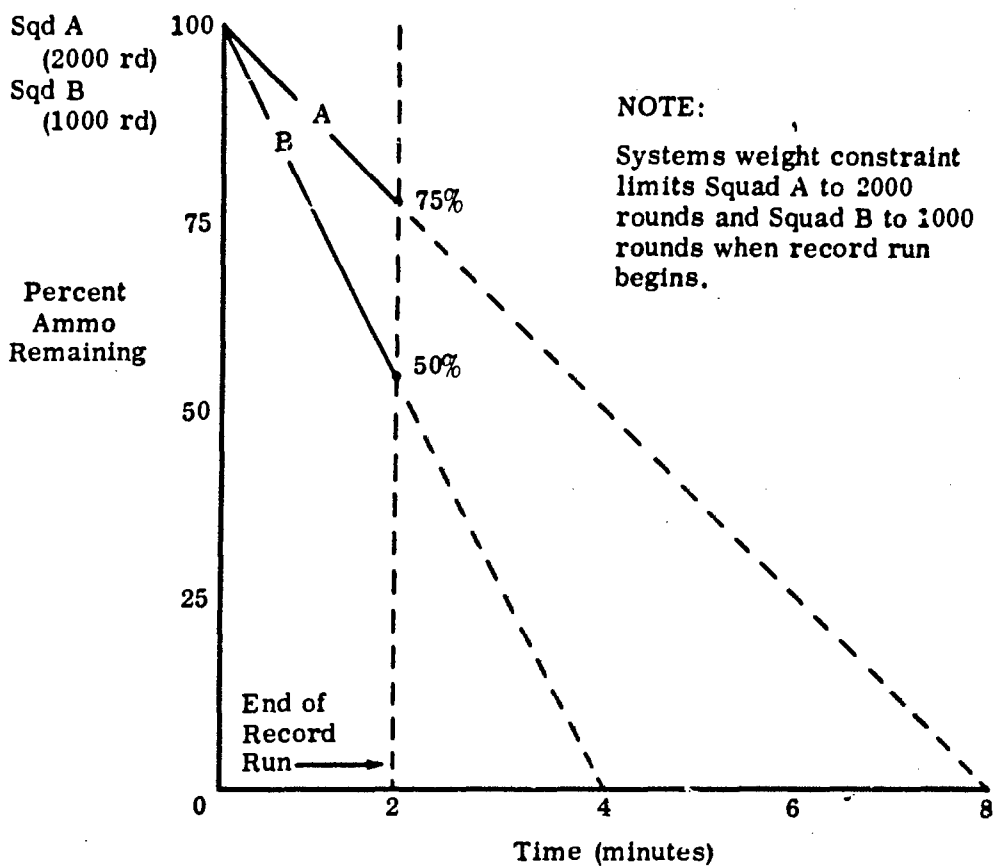

Figure 2-19  
EXAMPLE OF SUSTAINABILITY

### (3) Correlations

A correlation analysis was run on measures of effectiveness, both primary and collateral, to determine the extent of the relationships of the various measures to each other, and to gain further understanding of the nature of these relationships. Tables describing these relationships are presented in Annex D.

#### 3. Effectiveness Qualities - Combat Effectiveness Components

Combat effectiveness components important to the evaluation of small arms weapon systems include the following:

- a) Fire Effectiveness
- b) Weight reduction
- c) Tactical versatility
- d) Reliability
- e) Training
- f) Collateral applications

They are discussed and related to the output of the SAWS field experiment, in turn.

##### a. Fire Effectiveness

USACDCEC's primary contribution is in this area. This report provides the fire effectiveness results, and relates lethality to the effectiveness results.

##### b. Weight Reduction (Mobility)

Weight reduction results--rankings of squad weapon mixes according to the amount of weight that can be eliminated from the soldier's or squad's combat load if a sustainability advantage is taken out (even partly) in weight reduction--can be computed from the weights of the weapon systems and the sustainability results presented in Section VI. The shorter, lighter weapons were naturally more easily carried and therefore increased the soldier's mobility.

##### c. Tactical Versatility

This quality includes: 1) the relative capability of candidate weapons to perform the functions of the rifle, carbine, submachinegun,



automatic rifle, antitank grenade launcher, and M79 grenade launcher with the fewest number of weapon types; and 2) the relative suitability of the weapons for use by airborne, airmobile, mechanized and amphibious forces. The USACDCEC SAWS experiment implicitly covers some aspects of tactical versatility, particularly in the area of dismounted rifle and machinegun squads. For example, rifles, automatic rifles and machineguns were all fired in the automatic rifle role.

**d. Reliability**

This quality includes reliability, durability, ruggedness, and performance under extreme conditions. The experiment provided data on reliability-durability and operation in the field, including sandy conditions. Reliability results are presented in Section V:

**e. Training**

Training effectiveness for the experiment is discussed in paragraph D-4 of this section and in Section IV.

**f. Collateral Applications**

This includes such matters as suitability for use in the Military Assistance Program (MAP). The distinction between this quality and tactical versatility is one of degree. Insight into these areas can be derived from USACDCEC fire effectiveness, weight reduction, and reliability data. USACDCEC's answers to the essential elements of analysis (EEA) provided to USACDC by separate letter further relate USACDCEC SAWS data and results to some of these broader questions of collateral applications.\*

---

\* Letter, CDEC-TB, HQ USACDCEC, 1 April 1966, Subject: Essential Elements of Analysis (EEA), Small Arms Weapons System (SAWS) Program.

**BLANK PAGE**

### SECTION III

#### METHODOLOGY FOR THE PRESENTATION OF RESULTS

##### A. ORGANIZATION OF RESULTS

The data and results from which the USACDCEC SAWS conclusions were evolved are presented in Sections IV through VIII. Each Section deals with a particular type of experiment or data base.

Section IV deals with training implications.

Section V presents the results of the USACDCEC analysis of the materiel reliability data collected during the experimentation.

Section VI details the results of fire effectiveness experimentation designed to discriminate among squads armed with different weapon mixes. That section is divided into three parts. Part A, dealing with the rifle squad mixes for which experimentation was originally planned and mixes provided for either in the USACDCEC outline plan or in a subsequent directive from USACDC Headquarters; Part B, covering follow-on rifle squad experimentation and presenting results of an investigation into the feasibility of adopting a rifle squad equipped only with Colt automatic rifles, or with a combination of Colt rifles and Stoner machineguns; Part C, discussing the comparative machinegun experiment.

Section VIII is a brief note discussing the relationship between current lethality data and the USACDCEC SAWS results and conclusions.

Section IX presents USACDCEC SAWS conclusions.

##### B. DATA PRESENTATION FORMAT

The numerical results for situations in most cases are presented within the framework of a single large consolidated table (comprised of subtables) and a set of graphs. Tables and graphs for each situation are accompanied by brief descriptions of the situations, summaries of the respective tables and graphs, a list of standard scores, and a summary analysis.

Three types of data are presented: descriptive statistical performance measures; probability measures, and graphic presentations of the data as a function of time and range, where applicable.

Performance measures, (the effectiveness and collateral measures discussed in Section II, are used to rank the squad mixes. Probability measures provide the means of determining the extent to which experimentally observed differences are chance results caused by variations in the experiment.

If observed differences have a low probability of occurring because of experimental variations, it may be considered with a high degree of confidence that the differences in performance measures are caused by system differences. Performance measures and their ranking should not be used without reference to statistical probability measures.

Sections IV, V, and VII do not deal directly with fire effectiveness results. These data are presented primarily in a descriptive narrative format.

For purposes of brevity and clarity, it was necessary to assign a two-letter code designation to each weapon mix. The weapon mixes are referred to by this code in most of the tables and graphs of the report. The key is presented below.

- UA - 9 M14 Rifles
- UB - 7 M14 Rifles and 2 M14E2 ARs
- UC - 5 M14 Rifles and 2 M60 MGs
- UD - 9 M14E2 Rifles
  
- CA - 9 M16E1 Rifles
- CB - 7 M16E1 Rifles and 2 Colt ARs
  
- SA - 9 Stoner Rifles
- SB - 7 Stoner Rifles and 2 Stoner ARs
- SC - 7 Stoner Rifles and 2 Stoner MGs
  
- RA - 9 AK47 Rifles
- RC - 7 AK47 Rifles and 2 RPD MGs
  
- CX - 9 M16E1 Rifles (Same mix as CA, but used in follow-on experimentation as a control mix)
- CY - 9 Colt ARs
  
- MB - 7 M16E1 Rifles and 2 Colt ARs  
(Same mix as CB, but used in follow-on experimentation as a control mix)
- MC - 7 M16E1 Rifles and 2 Stoner MGs

## C. EXPLANATION AND DESCRIPTION OF DATA

### 1. Performance and Statistical Probability Measures

A difference will usually emerge if the characteristics of two mixes are measured. For example, one mix may measure 22 and another 20. A question then arises: does the observed difference represent a real difference in mixes, or is it due either to chance elements that affected the experiment or due to sampling variations?

There is no absolute yes or no answer, but statistical techniques can provide the probability that an observed difference is due to chance variation. This is the likelihood that a wrong decision would be made by rejecting (on the basis of the experimental observations) the hypothesis that there is no real difference in the systems.

In the example where one mix performance measured 20 and another 22, the probability can be estimated that if the experiment were repeated many times, a difference of two or more would occur from chance. Such a probability might turn out to be, for example, .03. If the mix that measured 22 were selected on this basis, there is a probability of .03 that the selection was wrong--wrong in the sense that there may be no differences in the system.

If a probability level of .20 is selected for rejecting the hypothesis of no real differences, there is a high risk in concluding that the observed performance difference reflects a real difference in mixes.

It is also possible to make another kind of erroneous decision, that of accepting the hypothesis that differences in a performance measure are due to chance when in fact there is a real difference in the performance of the mixes. The ability of a statistical test to indicate real difference in performance measures depends on the magnitude of the real difference and on the size of samples. These two factors influence the probability of observed differences in the performance measure and the magnitude of observed differences that will lead to rejection of the null hypothesis that there are no system differences. In this experiment, the sample sizes were as large as possible within the practical limit of the experiment, so that real differences in performance measures would have the greatest likelihood of being detected. Some real differences undoubtedly will remain undetected, but the rejection probability should be valid for any differences that are labeled significant.

The appropriate probability level for rejection is a matter of judgment involving a certain amount of risk. A low level for rejecting the hypothesis that the observed difference is real reduces the risk of erroneously concluding that there is a real difference when there is not, but it increases the risk of rejecting a mix that might in fact be superior in the quality measures.

To facilitate this judgment process, the report, for the majority of the results, presents a subtable for each measure presented in a situation, showing the probabilities that can be attached to experimentally observed differences in each possible pair of squad mixes. The probabilities are presented in numbers up to .40. These tables might indicate, for example, that the chance that the observed difference between mixes A and B could be equal to or greater than the measured amount is .08. As these probability figures more closely approach the value of .50, the risk that the experimentally measured differences were caused by chance factors becomes greater.\*

Presented on the following pages are Subtables A and H from the table for Situation 2, which treats cumulative exposure time (CET).

Subtable A shows the mean (average) raw CET score in minutes of total target exposure time of each squad mix, and the standard deviation (SD) of each mix's score. Finally, it shows the mean standard score ( $z'$ ). (The standard score concept will be discussed further below.) At the bottom of Subtable A is shown the mean (average) of the squad mix mean scores ( $\bar{X}$ ), and its standard deviation (SD).

Each measure for the rifle squad experiment is also illustrated in a series of bar graphs located on the same foldout page as the numerical data and probability table presentations. The bar graphs portray the mean (average) scores of all mixes, the range of all squad scores, and the ranges of the six squad scores comprising the highest and lowest scoring mix for each measure for each situation. In addition to these bar graphs, histograms (a type of bar-graph representation) and graphical representations of distributions of measures as a function of time and range are presented for some experimentation situations. These two methods of data presentations are explained in paragraphs C-6 and C-7 of this section.

The bar graph for Situation 2 (Rifle Squad As A Base of Fire Supporting the Assault) should be referred to for comparison with Subtable A being discussed here. The first block of the graph shows CETs that were also treated in the first table of statistical figures, Subtable A. The first bar on the left shows the mean scores corresponding to mean CETs in Subtable A; the second bar shows the range of all squad scores regardless of

---

\* It should be noted that these probabilities are not offered as precise confidence levels for formal tests of null hypotheses. Such a test would require either an a priori statement of the particular pair of mean values to be compared, or a composite analysis of variance with the pairwise test being used to identify significant analysis of variance contributions. In the absence of a significant F test these probabilities should only be considered to provide a rough indication of the relative importance of the magnitude of the differences tested.

Subtable A—CUMULATIVE EXPOSURE TIMES

Mix	$\bar{X}$ CET	SD	Standard Scores z'
UA	77.5	2.3	77.1
CA	78.2	10.0	71.2
UD	78.6	8.3	68.3
UB	80.0	6.6	59.0
SC	80.4	9.4	53.8
SB	81.0	10.1	48.9
SA	82.0	9.1	41.4
CB	82.1	4.6	40.4
UC	84.2	7.2	23.6
RA	85.1	10.9	16.6
$\bar{X}$	80.9		
SD	2.52		

Subtable H—CUMULATIVE EXPOSURE TIME p FACTORS

	UA	CA	UD	UB	SC	SB	SA	CB	UC	RA
UA		>.40	.38	.22	.24	.21	.14	.03	.03	.07
CA			>.40	.38	.35	.32	.26	.20	.13	.15
UD				>.40	.37	.33	.26	.19	.12	.15
UB					>.40	>.40	.32	.24	.15	.17
SC						>.40	.39	.35	.23	.23
SB							>.40	>.40	.27	.27
SA								>.40	.32	.31
CB									.28	.28
UC										>.40

the squad mix; the third bar shows the range of scores of the leading rifle squad mix (the UA mix composed of nine M14 rifles); and the fourth bar shows the CET score range for the lowest ranking rifle mix (the RA mix composed of nine AK47 rifles) (page 6-23).

The performance measure tables and the graphs complement each other, both showing the mean average scores for each mix in rank order. The tables also provide standard deviations, while the graphs provide the range of scores contributing to these deviations.

## 2. Combined Use of Descriptive Performance Measures and Statistical Probability Data

Subtables A and H (CET for Situation 2) shown above can be used to illustrate how the two types of data should be used. Subtable A indicates that mix UA (nine M14 rifles) ranks first with a CET of 77.5 minutes and mix CA (nine Colt rifles) is second with mean CET of 78.2 minutes. Subtable A does not state whether this difference as measured in the experiment is a statistically significant difference. In other words, if further experiments were conducted, what are the odds the results would go the other way? If the odds are high, it should be concluded that the measured difference is not statistically significant and that, for practical purposes, one system appears as good as the other as far as the particular measure is concerned.

In the case of the UA and CA comparison, a measure of such odds can be obtained by referring to the Subtable H adjacent to Subtable A, which shows probability (p) factors (for the two sample t-statistics). In the cell of row UA and of Column CA is the factor  $p > .40$ . This p-value indicates that a low level of statistical confidence attaches to the experimentally observed difference in Situation 2 CET as between UA and CA. As far as the experimental results are concerned, UA and CA in this situation appear about equally effective in CET.

In a comparison of UA with UC (five M14s and two M60s), however, one can read across the p-value table and see the number .03. In this comparison, confidence in the conclusion that UA is superior to UC is relatively high.

The combined use of statistical probability measures and the performance measures can serve as an aid for analysts and decision makers. In the case of the UA and CA comparison ( $p > .40$ ) discussed above, there is little evidence for concluding that there is a real difference between mixes on the measure of CET. However, the systems may very well be different regarding the other effectiveness measures. Subtable B for Situation 2 (page 6-23) shows that in near misses CA scored 323 and UA scored 259. The statistical probability is .05. Similarly, in sustainability (Subtable C) (page 6-23) CA scored 50.5 and UA 22.0, with  $p = .001$ . Thus it



might be concluded in this situation that the CET qualities of CA and UA are a toss up but that the experimental evidence strongly supports the conclusion that CA is superior to UA in near misses and sustainability. On this basis it might then be concluded that the experimental results in Situation 2 indicate that CA is the superior mix.

Successive pairs of systems can be analyzed by situation and event in the same fashion as above. Such a process, however, is time consuming and requires judgment at numerous points. One important type of judgment centers on what is the appropriate probability that should be used. Other judgments must center on possible tradeoffs suggested by the data. For example, System A produces 10 percent more near misses than System B but, relative to B, has 30 percent less sustainability in terms of the percent of ammunition remaining. Is such a tradeoff, or price in sustainability, worth the extra near misses? In part, the answer would depend on the absolute sustainability scores attained. It is one thing if A has a sustainability score of 80, and B, 50; perhaps another if A had 40 and B had 10. In the latter case a hypothetical squad might be in poor condition to resist an immediate counterattack after a successful attack.

However, it may be neither practical nor possible to go through a detailed analysis of the kind suggested here as a means of evaluating weapon mixes. It is therefore, desirable to provide an evaluation and appraisal of weapon mixes, preferably by a less involved method. To facilitate such an analysis, the concept of standard scores is useful. Hence, a short discussion of standard scores is presented in each subtable for each experimentation measure and in summary subtables.

### 3. Standard Scores

Scores obtained for weapon mixes for each of the measures in the SAWS experiment are not directly comparable between situations or between measures. For example, CET is measured in minutes, near misses in actual number, and sustainability in percent of ammunition remaining. Moreover, CET may average 3 minutes in one situation and 20 in another. In dealing with such observations, it is desirable to have scores that can be easily compared. This is what standard scores do.

Consider the following hypothetical example for a situation.

Measure of Effectiveness	Mean Score $\bar{X}$	SD	Raw Scores		Deviations		Standard Score (Z)		Adjusted Std Score (Z)	
			Mix		Mix		Mix		Mix	
			A	B	A	B	A	B	A	B
Near Misses	155.7	26.4	196	162	40.3	6.3	1.53	.24	79.8	80.6
CET	33.7	8.2	20	44	-13.7	10.3	-1.67	1.25	16.6	75.0

In this example, the mean score ( $\bar{X}$ ) represents the average of the raw scores of the ten mixes in a given situation. The example also shows the standard deviation (SD) of these raw score averages.

Consider next the raw score measures for Mixes A and B. Note, for example, Mix A's near miss performance deviates from the mean score of all mixes by 40.3. When this raw deviation for the mix is divided by the standard deviation of the group score (26.4), the standard score (Z) of 1.53 is obtained.

Such measures have a mean of zero and a standard deviation 1. To eliminate negative scores and put them on a scale similar to conventional scoring methods, they can be adjusted by selected constant factors. For the purpose of this experiment, they were adjusted as follows:

$$z' = 50 + 20 \frac{X_1 - \bar{X}}{SD}$$

where the expression in the brackets represents the standard score z, as shown in the table above, and z' represents the adjusted standard scores.\*

The standard score, therefore, is used in this report as a numerical representation, or index, to facilitate understanding the relative effectiveness of each weapon system mix in each situation. A standard score that is below 50 automatically indicates that the actual performance of that weapon mix was above the average for that measure.

The standard scores not only provide an immediate index of whether weapons systems performance is above or below the average but they also provide an immediate visual index of how far that squad weapon mix's performance deviates from the average in relation to how far the other mixes deviate from the same average.

\*  $X_1$  is the raw score of the mix,  $\bar{X}$  is the average raw score of all mixes, and SD is the standard deviation of the raw scores for all mixes.

The standard scores thus provide a ready means of combining the various performance measures. All performance measures (CET, near misses, sustainability, number of targets hit, and total number of hits) now have an identical average score of 50 and identical standard deviation of 20. Thus, if a weapon mix is above average in both CET and near misses, the results of combining these standard scores, no matter what weights were assigned to each must show a resulting mean (average) standard score of above 50--since its above average performance on both measures required it to have a standard score of above 50 on both measures. Therefore, although raw scores of different variables cannot be meaningfully combined, the standard scores can.

The combining of standard scores rather than the direct averaging of ranks, or some similar method, also takes into consideration the relative superiority or inferiority of the performances of different mixes on different measures. For example, it will be noted that mix UA did better than mix SB on the target effectiveness measure of CET in Situation 5--but that mix SB did better in the other target effectiveness measures of the number of near misses. If a decision were to be made to weight these two measures equally, the conclusion might be drawn that UA and SB were equal to each other in target effects, since UA was higher than SB on one of the measures while SB was higher on the other measure. A comparison of the standard scores presented below, however, might lead to a different conclusion.

Mix	CET		Near Misses			Target Effects
	Rank Order	Std Score	Rank Order	Std Score	Rank Order	Std Score*
UA	1	54.45	2	46.7	2	(Av of CET and NM) 50.57
SB	2	53.67	1	71.3	1	62.49

\* If CET and near misses were weighted equally

Therefore, combining standard scores to assist in the interpretation of results automatically considers that although mix UA was better than mix SB in CET, the difference was very slight; but that in the case of near misses, when SB was better than UA, the difference was relatively much larger.

\* If CET and near misses were weighted equally.

#### 4. SAWS Target Effects and Overall Effectiveness Scores

Subtables F and G of the consolidated tables for each situation present the average standard scores for each mix in target effects and overall effectiveness. Subtable F provides, in rank order, the overall standard scores for target effects (CET and near misses) combined. Subtable G presents the overall standard scores, in rank order, of the weapon mixes for target effects (CET and near misses) combined with the third primary effectiveness measure of sustainability (percentage of basic load of ammunition remaining at the conclusion of each situation).

Subtable F, therefore, presents the overall standard scores of weapon mixes rank ordered according to their overall target effects. For illustrative purposes, CET (representing targets hit as a function of time) has been equated in Subtable G with near misses (representing the number of near misses per unit of time). There are, mathematically, an infinite number of weightings that can be given other than the arbitrary 1-to-1 weights presented. If it were desired, for example, to weight near misses in the assault twice as much as CET, then the near miss standard score provided in Subtable B would be multiplied by 2, added to the CET standard score for Subtable A, and the result divided by 3.

In Situation 4 (Rifle Squad Approach to Contact), Situation 7 (Rifle Squad in Day Defense), Situation 8 (Rifle Squad in Night Defense), and Situation 9 (Machinegun Squad in Day Defense) near misses were not measured. Therefore, the overall target effects standard scores presented in Subtable F are based solely on CET. Thus, for these situations, the standard scores in Subtable F are identical to those in Subtable A (CET).

Subtable G presents the combined overall standard scores for each situation for all of the primary effectiveness measures (CET, near misses, and sustainability). In other words, Subtable G combines each of the primary effectiveness measures used in the experiment into an overall effectiveness criterion and rank orders the weapons mixes accordingly. It must be emphasized that these rank orders, for illustrative purposes only, weight each of the primary effectiveness measures equally. Thus, CET, near misses, and sustainability each contribute to one-third of each weapon mix's overall rank order, which in effect weights target effects (CET and near misses) two-thirds and sustainability one-third.

In Situations 4, 7, 8, and 9, where scores for target effects are based solely on first hits as a function of time (CET), target effects are still weighted two-thirds and sustainability one-third. Thus, regardless of the situation, the overall ranking of weapon mixes, as presented in Subtable G, is always the result of giving sustainability a weight of one-third.

For rifle squad Situation 2 (Base of Fire supporting the Assault), Situation 5, Rifle Squad as a Base of Fire Supporting the Advance), Situation 7 (Defense Against Attack), and Situation 8 (Night Defense Against Attack), there is a fifth column for each Subtable C (Sustainability). This

column (titled "Sustainability Time") lists, in minutes, the amount of time that each of the given squad mixes would be able to sustain itself in that situation. Thus, if a squad weapon mix fired 75 percent of its ammunition over the 4 minute duration of Situation 2 (Base of Fire Supporting the Assault), the weapon mix was considered capable of sustaining itself in such a situation for 5.33 minutes.\*

5. Expected Scores

The method of computing expected scores was the same for Series 1 and 2 of Situations 7, Series 1 and 2 of Situation 8, and the duplex experiment. The equations used to calculate expected scores for primary and collateral measures and the basic proportions used in these calculations were the same for each situation. This basic format was constructed as follows:

	<u>Experimentation</u> <u>Squads</u>	<u>Control</u> <u>Squads</u>
Series 1 (first firing)	$A_m$	$B_m$
Series 2 (second firing)	$C_d$	$D_m$

M = The mode of fire (ball or duplex, automatic or semiautomatic) used by all squads of the mix during their first firing of the situation

\* The figures presented in the subtables of the various tables for each event provide the USACDCEC SAWS data in terms of means (averages), standard deviations, standard scores, and probabilities (illustrating levels of significance). However, there are a number of technical rules for the precise interpretation of these statistics; and a number of mathematical assumptions that must be satisfied if these are to be used precisely and in the most meaningful manner. In the final analysis, each score and statistic presented can be looked at and considered only in conjunction with all other statistics of the table. Thus, rank orders of weapons systems and standard scores have full meaning only in conjunction with the values in the probability subtables (H, I, J, K, and L). Furthermore, for a precise interpretation, it is necessary to be thoroughly familiar with the many assumptions inherent to the various statistical procedures and measures used and to understand thoroughly the mathematical relationships between these measures. An attempt has therefore been made to provide sufficient data to allow the reader to reconstruct the various situations, perform his own analyses, and draw his own conclusions. In this respect the chi square values for Bartlett's Test for Homogeneity of Variance as well as F values and corresponding probabilities for these F ratios are also presented.

**D = The mode of fire used by three of the six rifle squads during the second firing, and the mode against which a comparison with the first firing's M mode was desired**

**A<sub>m</sub>=Average scores for the three experimental squads (usually the odd numbered squads of the mix) after their first firing in M mode**

**B<sub>m</sub>=Average score for the three control squads (usually the even numbered squads of the mix) after their first firing in M mode**

**D<sub>m</sub>=Average score for the three control squads after their second firing of the situation using M mode**

**C<sub>d</sub>=Average score for the three experimental squads after their second firing of the situation, but using D mode rather than M, which was used during their first firing, and which control squads continued using**

The equation used to calculate the expected mix score (the score that would have been expected of the entire six squad mixes from the first firing of the situation if mode D, rather than M, had been used) reads:

$$\text{Mix Expected} = \frac{(A+B) \left(1 + \frac{BC - AD}{AD}\right)}{2}$$

**6. Graphical Presentation of Measures as a Function of Time and Range**

Results for rifle squad situations are also presented in the form of graphs. Hits, near misses, total hits, percent of ammunition expended, and number of rounds fired are illustrated all as a function of time and range. Except for Situations 7, and 8, time is represented on one axis and the measure of effectiveness on the other. All the measures indicated above may not be represented on all graphs.

Because the targets were programmed to rise and fall in sequence at different times in Situations 7 and 8, either individually or in groups, distributions of the effectiveness measures as a function of scenario time were not applicable. For Situation 7 and 8, therefore, the measures have been cumulatively plotted, starting with the targets at the greatest range (which came up first) and cumulating the measures through the assault targets that were closest to the firers and came up last.

These graphs present the relative effectiveness of the various weapon mixes at different ranges, and at different times in each situation. They also permit a ready analysis by weapon mix of the relationship of the various measures to each other at varying ranges and times.

For example, Figure 3-1 illustrates the distribution of targets hit and near misses for hypothetical Mixes A and B in Situation 1 (Rifle Squad in Line Assault).

The time scale is presented at the bottom of each graph. The range scale is presented on the center line between two graphs.

An examination of the graphs by comparing the maximum point of each curve (intersection of curves with right vertical axis) shows that Weapon Mixes A and B are equivalent in total number of near misses (400), but that Mix B is superior to Mix A in the number of targets hit during the Assault Situation (6.5 versus 4.5). Examination shows that the squads of Mix A averaged their first target hit (indicated by \* on the curve) in the Assault at a range of 50 meters from the targets while Mix B averaged its first hit in the Assault at a range of 100 meters from the targets. A comparison of the curves further shows that Mix A squads hit, on the average, only one target during the movement from 130 meters in to 50 meters, while Mix B during the same time of movement across the same amount of ground had hit an average of three targets. However, the slopes and increase in curve ordinates between 50 meters and the end of the assault (30 meters from the targets in the experiment due to danger of damaging ground level target instrumentation) shows that both mixes averaged an identical 3.5 targets hit during this period. Examination of these graphs indicates that both mixes were equivalent in the Assault in their suppressive fire effects as a function of near misses and in their ability to hit targets at a range of 50 meters and closer, but that Mix B is superior in its ability to hit targets at ranges of more than 50 meters. Mix B's overall superiority at the completion of the Assault is therefore due solely to its superiority in attaining hits at ranges of more than 50 meters.

Figure 3-2 presents data for hypothetical Mix C from Situation 2 (Rifle Squad as a Base of Fire in Support of the Assault, ranges of 269 to 326 meters). The center vertical dashed line represents the division between the two target arrays. (See Section II for a description of Situation 2.) The first 2 minutes of fire were directed at the left array of 17 targets. At the end of 2 minutes (indicated by the time scale on the horizontal axis) firers shifted fire to the right array to reproduce the effects of the shift of fire that is necessary when the assault element closes with the enemy position.

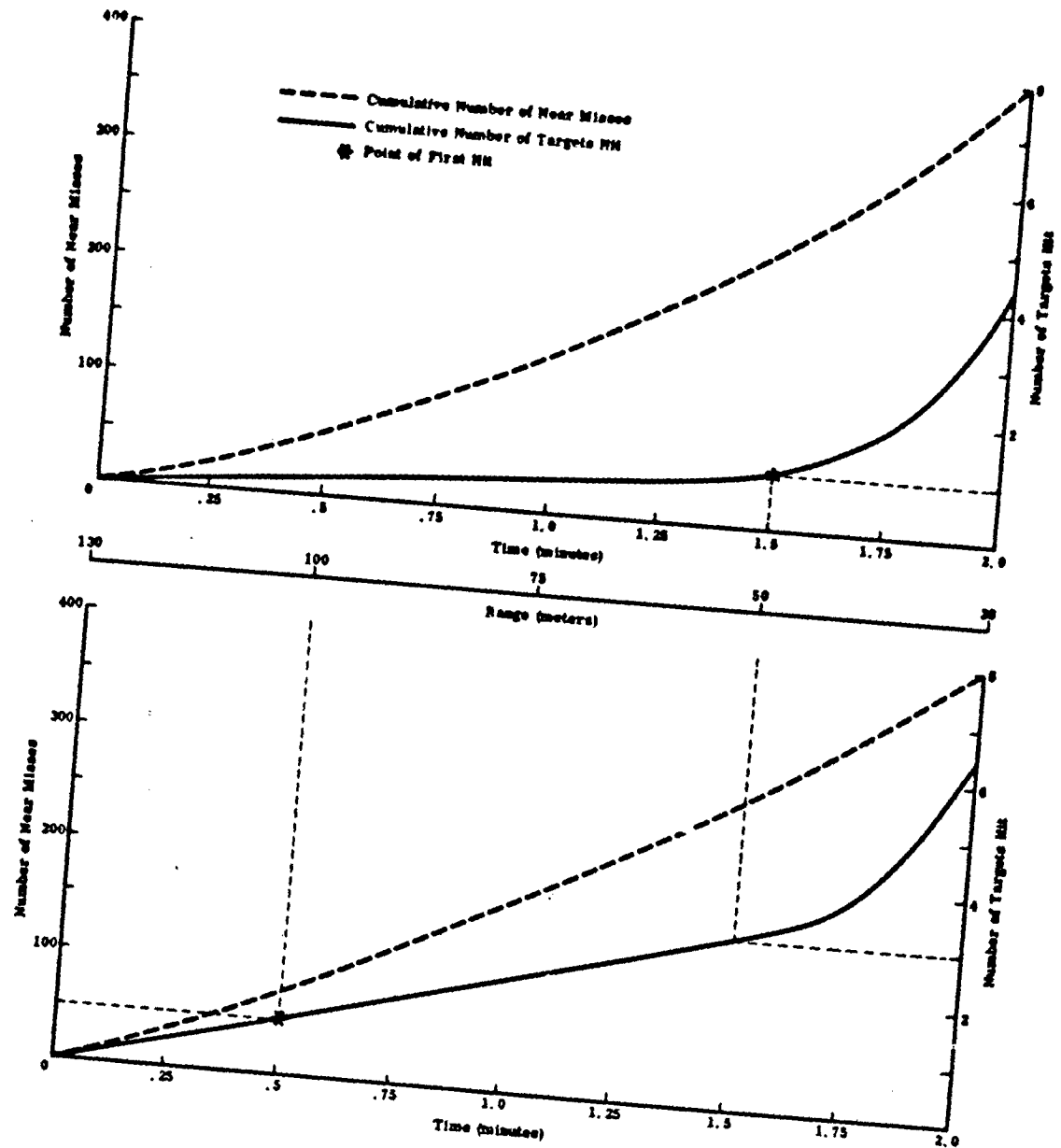

Figure 3-1 DISTRIBUTION OF DATA, HYPOTHETICAL WEAPON-SQUAD MIX A (top) AND MIX B (bottom) IN SITUATION 1 (RIFLE SQUAD IN THE LINE ASSAULT)



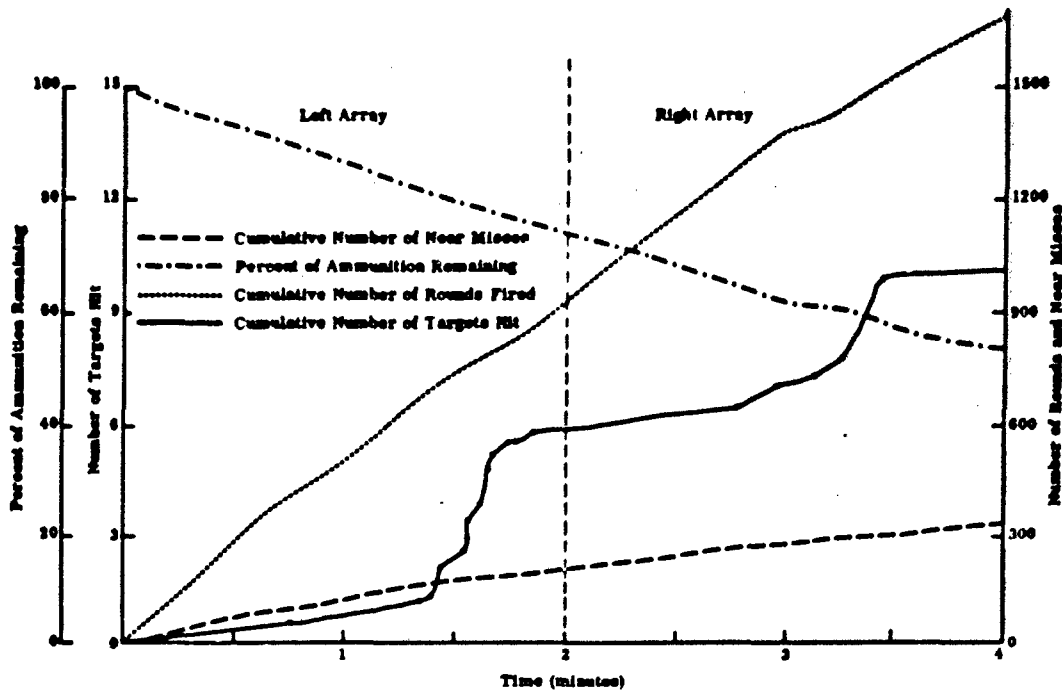

Figure 3-2 DISTRIBUTION OF DATA, HYPOTHETICAL WEAPON-SQUAD MIX C IN SITUATION 2 (RIFLE SQUAD AS A BASE OF FIRE IN SUPPORT OF THE ASSAULT)

In this example (Figure 3-2) it can be seen that the number of rounds fired and the number of near misses rose steadily and at a constant rate throughout the 4 minutes of fire. For every near miss registered within 2 meters of a target there were 5 rounds fired. By comparing the ends of the curves, it can also be seen that there were 1700 rounds fired and 10.5 targets hit, or one target hit for each 162 rounds fired. But, unlike near misses and ammunition expenditure, most of the targets hit for each array were hit during the latter portion of the 2 minute firing times. The graph shows that even though the rate of ammunition consumption and near misses for hypothetical Mix C is constant during the entire situation, the rate of hits is not. There were practically no hits during the first minute of fire on each array; however, during the latter part of the firing on each array the rate of hits increased at an extremely high rate. A gentle sloping curve, therefore, indicates that there were few hits while a steep slope of the curve indicates a high rate of hits.

Figure 3-3 presents an example of cumulative exposure time (CET) plotted as a function of range for a situation similar to Situation 7. In this situation targets rose individually or in small groups for brief exposures. The program provided for a sequence of target exposures starting at distant ranges and culminating in the exposure of ten close range (approximately 45 meter) targets. The exposure times of each target are cumulated from the most distant target through the closest target (from left to right on the horizontal axis of the graph). If every target were hit at precisely the same instant that it appeared, the target exposure time would be theoretically zero and the CET curve would be a horizontal line corresponding with the horizontal axis of the graph. On the other hand, if no target were ever hit, each target would remain up for its entire programmed exposure time, represented in Figure 3-3 by the curve labeled CPET (cumulative programmed exposure time). Therefore, all curves for all mixes must fall somewhere between the CPET curve and the horizontal axis. Thus, the mix with the CET curve closest to the horizontal axis hits the targets the quickest. The intersection of this curve with the right vertical axis of the graph represents the CET of that mix for the entire situation. A comparison of the slopes of the curves of any two mixes for any range increment will show which weapon mix was superior at that range. The mix with the curve that has the steepest slope at any given range is the poorest mix at that range.

Also illustrated are curves for the number of targets hit, the total number of hits and ammunition expenditure. From Figure 3-3, it can be seen that ammunition expenditure was greatest at the longer ranges while the number of targets hit was the least, and that it took longer to hit the targets that were hit. At the closest ranges (45 to 60 meters), however, there was very little ammunition expended (almost horizontal slope of the "rounds fired" and "percent of ammunition remaining" curves), yet the curves for both number of first hits (targets hit) and number of total hits on targets increases sharply in slope. Furthermore, not only are more

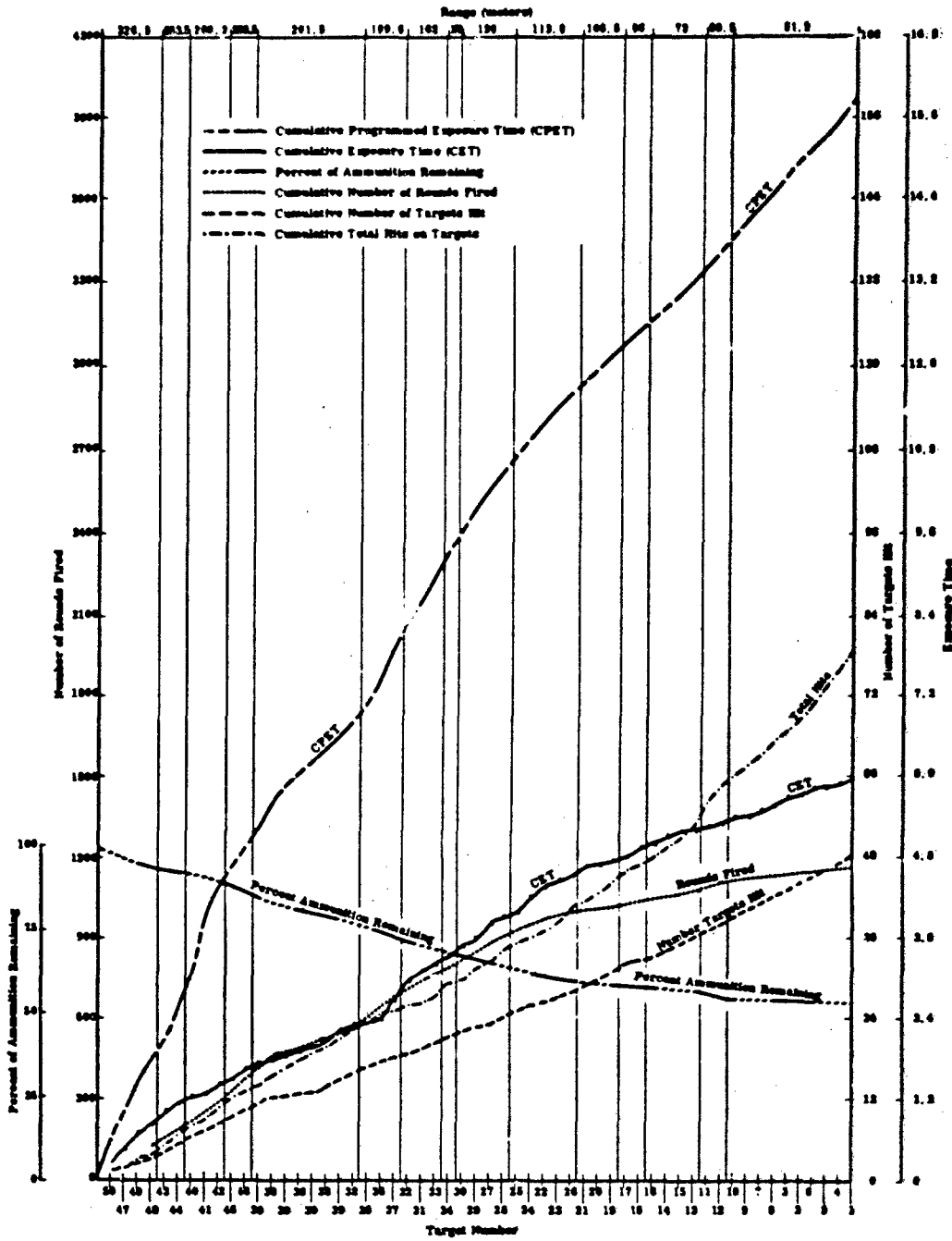

Figure 3-3 EXAMPLE OF CET AS A FUNCTION OF RANGE

targets hit but they are hit more quickly, as indicated by the relatively flat CET curve at the 45 and 60 meter ranges. The fact that the targets were hit so quickly can, of course, be related here to the fact that very little ammunition was expended. Had the targets not been hit so quickly, they would have been fired at for a longer time with a resulting increase in the amount of ammunition expended.

These graphical presentations of the distribution of effectiveness measures as a function of time and range permit a ready comparison of the behavior of the various effectiveness measures within a weapons mix, while at the same time permitting a comparison of the mixes with each other at varying ranges and under varying conditions.

#### 7. Histogram (Bar Graph) Presentation of Near Misses as a Function of Target Location

For situations where near misses were recorded, the distribution of near misses across the target arrays are presented in the form of histograms, as in Figure 3-4. There is one histogram for each mix for each applicable situation. Each vertical bar represents one target. The height of the bar depicts the average total number of near misses by the six squads of the weapon mix for that target. Each set of histograms is accompanied by a schematic sketch (to scale) of the target array to which the histogram applies. The type of weapon simulator associated with each target and the target number is given at the bottom of each vertical bar. The targets (vertical bars) are shown from left to right in the same order that they appear in the actual array (and in the inset schematic).

A comparison of the relative effects of automatic firing and semiautomatic firing weapons regarding distribution of fire patterns is possible through a comparison of these histograms, as is a comparison of the relative suppressive effects of the different weapon systems and mixes. An analysis of the distribution of fire in the target area relative to the type of enemy fire from the position allows conclusions to be drawn regarding the extent to which fire is drawn to automatic weapons as opposed to relatively slow firing semiautomatic rifles (indicated by R on the histogram).

The example (Figure 3-4) shows no apparent relationship between types of enemy weapon and distribution of fire at first glance. In fact, Position 10, a rifle position firing a small volume of semiautomatic fire (simulator fired spaced single shots), received more near misses than any other target. However, examination of the inset schematic of the target array shows that this target was located directly in front of a machinegun and down the slope from it. It is also located between many of the firers and three other targets (two rifles and one automatic rifle). Therefore,

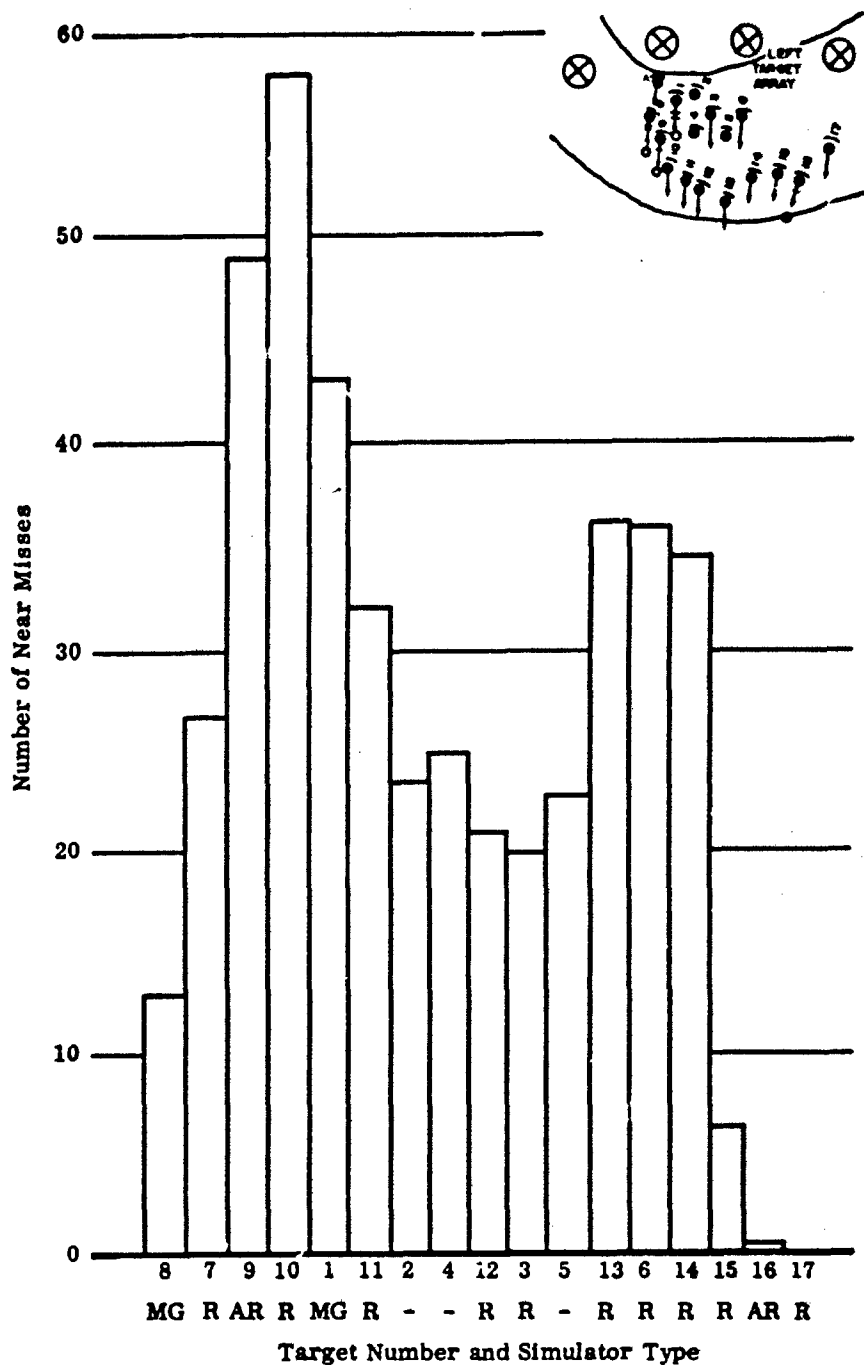

Figure 3-4 HISTOGRAM (BAR GRAPH) PRESENTATION, NEAR MISSES AS A FUNCTION OF TARGET LOCATION

It can be seen through a comparison of the histogram and the schematic sketch that rounds fired at a machinegun, an automatic rifle, and two other riflemen would all pass close to Target 10. Thus, one round of ammunition may register as a near miss on as many as four different targets, in the same manner that one round is capable of contributing to the suppressions of more than one soldier in combat. It also becomes obvious that a ratio of the total number of near misses (as registered in the SAWS experiment) to the number of rounds fired cannot be interpreted as the probability that any given round will be within a given distance of the target. For example, if 2000 rounds were fired by a weapon mix and 200 near misses were recorded, it does not mean that one out of every ten rounds ( $\frac{2000}{200} = 10$ ) passed within the 2 meter near miss zone of a target, because one round may have been registered as a near miss by two or more targets.

This histogram may therefore be used as a primary tool for analysis of the mechanisms of distribution of fire, interactions of target-firer characteristics, and for comparison of the various weapon mixes regarding both suppressive fire and distribution of fire characteristics. Not included in this report, but available at USACDCEC for analysis, are detailed breakdowns of near misses for each individual target as a function of time and range. When related to data regarding the frequency that specific targets were hit, analysis permits a determination of the pattern of random and aimed hits as a function of distribution of fire.

#### D. ANALYSIS AND DERIVATION OF CONCLUSIONS

The following five sections (Section IV through VII, and IX) present results of the SAWS experiments and deal with the USACDCEC SAWS conclusions and the analyses from which the conclusions were evolved.

USACDCEC has, in effect, presented the results of the SAWS experiment in a format of tables and graphs allowing independent mathematical analysis of the data presented. At the same time decision makers are permitted to integrate military judgment into the mathematical results.

In formulating its conclusions, USACDCEC has exercised military judgment only to the limited extent that on some occasions a judgmental decision had to be made, regarding, for example, the implications of the ability of a weapon to sustain itself when all other things were equal. If target effects are approximately equal for two weapon mixes, but one mix is significantly better than the other in its ability to sustain these effects, then the weapon mix with the sustainability advantage would normally be chosen. In like manner, although the average score for one mix might be superior to the average score for another mix, it becomes necessary to consider just how valid and of how much practical importance the differences are.

In combining scores for the presentation of combined overall results in the various tables, cumulative exposure time, near misses, and sustainability were weighted equally (except where near misses were not measured), as were each of the rifle squad situations. However, before any conclusions could be drawn on the basis of rank orders, raw scores, or standard scores, it was necessary to consider each difference in connection with the probabilities that the numerical differences were really valid differences and not the result of operations of chance factors. It was then necessary to conduct sensitivity analyses of the data to determine the degree of sensitivity of the rankings to changes in the weightings of the criterion measures and situations.

For example, Mix SC (seven Stoner rifles and two Stoner machineguns) ranks in the top position in combined target effects across all rifle situations. Sensitivity analysis showed that it also ranks at least third in every situation and was superior in target effects to every US 7.62mm mix in each of the six situations. Therefore, it does not matter how much any given situation is weighted, the mix composed of seven Stoner rifles and two Stoner machineguns always comes out superior to every one of the US 7.62mm mixes. It may therefore be concluded that Mix SC is superior to any 7.62mm weapon mix in target effects.

Analysis of the quantitative differences between weapon mixes (or systems), judged by the quality of the differences as indicated by various statistical measures including probabilities (statistical significance of the differences), provided the mathematical context from which USACDCEC SAWS conclusions were evolved.

As stated previously, the end results are relatively insensitive to varying the weights of the different situations and effectiveness criteria. No matter how much weight is assigned, the same weapon systems consistently come out ahead of the others in target effects, sustainability, and overall effectiveness.

Despite the numerous presentations in this volume, the data base has scarcely been touched. The quantity and nature of the SAWS data is sufficient to evoke and feed a thoughtful and fruitful analytical endeavor for many years. For example, the brief discussion describing the graphical and histogram presentations of data (paragraphs 6 and 7 of this section) provides the basis for an entire anatomy of analysis. Reflective examination of the time histories of fire effects, ammunition consumption, and distribution of fire effects provide keener insights into the use of small arms. There are numerous ways in which the data can be synthesized or combined to provide further insight into weapon choice, organization, and doctrine.

**BLANK PAGE**



## SECTION IV

### TRAINING RESULTS

The primary measures of training performance were firing scores on the various ranges. Firing scores were taken at fixed points in the training program. At each of the times firing scores were taken, each weapon system group had the same amount of training of the same kind under comparable conditions.

Thus, the scores obtained reflect, in part, any weapon system differences that might have existed when the measures were taken. However, these scores were also affected by such factors as weather, time of day, visibility, and motivation, all of which often differed from day to day. Their exact quantitative influence is often not assessable in precise measurable terms, and they must be often accepted as sources of uncontrolled variation. Where there were differences in group scores, the differences may have resulted from differences in ease or effectiveness of training, or from some other weapon system characteristics that are not affected by training, or from uncontrolled factors of the type mentioned above. The fact that the scores may have reflected more than one factor does not invalidate the results of the training assessment, but it makes for a less precise interpretation of results than would otherwise be the case. The interpretation of results also depends on the assumption that the selection process produced weapon system groups that were comparable in learning ability and trainability in small arms firing. There were no known sources of selection bias.

#### A. RIFLE

##### 1. Disassembly and Assembly

Four tests were carried out to determine the ability to disassemble and assemble the different weapons. For each test, the men were required to disassemble the rifle, and their performances were timed. Times required for all men to disassemble their weapons on the first trial of each test were averaged for each weapon system group. Assembly tests were carried out in the same manner. The first trial of each of the four tests was timed and weapon system group averages were computed. The average times for each test are presented in Table 4-1. When a man had difficulty in disassembling or assembling a part or parts of the weapon, he received assistance from the instructor. These periods of assistance are reflected in longer disassembly and assembly times. It is notable that as the men equipped with the Stoner and M16E1 became more familiar with their weapons they required less assistance, and their times rapidly decreased

**Table 4-1**  
**RIFLE**  
**DISASSEMBLY AND ASSEMBLY TEST**  
**(Average Times)**

Weapon	Test	Average Disassembly Time (Seconds)	Average Assembly Time (Seconds)
M14 (1)	1	47	75
	2	31	54
	3	23	53
	4	20	51
M16E1	1	119	207
	2	72	124
	3	50	99
	4	30	50
Stoner Rifle	1	116	172
	2	79	115
	3	69	99
	4	27	50
M14 (2)	1	42	69
	2	29	52
	3	26	52
	4	23	49
M14E2	1	47	74
	2	38	60
	3	29	57
	4	24	56
AK47 (1)	1	27	50
	2	22	33
	3	12	25
	4	10	24
AK47 (2)	1	36	63
	2	24	37
	3	16	30
	4	15	28

to approximate that of the M14 group (which had received training in their weapon before the training experiment). On the first test, the differences in performance times for the various weapons were quite marked: the AK47 times were shortest, followed by the M14 and M14E2, the Stoner rifle, and the M16E1. On each succeeding test, the differences were reduced, and by the fourth test they were small. These trends are presented graphically in Figures 4-1 and 4-2. The fourth test did not include removal of the Stoner forestock assembly or the Colt handguard assembly. Therefore, the times for the fourth Stoner and Colt test are not comparable to the results obtained on the earlier Stoner and Colt rifle tests or the other weapons tests.

The least difficult weapon to disassemble and assemble proved to be the AK47. Subjects also were able to disassemble or assemble this weapon more quickly than any other.

Although tight fitting parts caused initial difficulty with some US weapons, this situation was later corrected. It is concluded that there are no tactically significant differences among US weapons regarding ease of disassembly or assembly, or the times required for disassembly or assembly after equivalent training.

## 2. Trainfire Record Range

Two ranges were used in these firings. All groups fired the record ranges twice. On the second record firing, half of each weapons group fired on each of the two Fort Ord Record Ranges (Range 18 and 19) to balance out range differences. Each man fired about 96 rounds on the record range. Individual hit tabulations were made, and the scores were based on the average number of hits achieved by each weapon system group. The average scores for each group, and for each firing on each range are presented in Table 4-2. The scores range from 44.00 for an AK47 group on their second firing (Range 19) to 57.71 for an M14E2 group on their second firing (Range 18). It should be noted that all record firings were made in semiautomatic fire.

Only four groups of firings by different weapons are directly comparable. M14 Groups K and L are comparable to Colt Groups M and N. For all other record firings, condition of camouflage on the ranges, weather, time of day and other factors were different. Because of time and range limitations a balancing of record firings was not possible. However, it was clearly determined that record scores secured by firers were more a function of the particular range used and the time of day than of differences in either firing ability or weapons. For example, firers who fired on Range 18 in the afternoon always did extremely well and achieved a relatively large number of expert qualifications, regardless of the personnel or weapon used. In contrast, firers who fired on Range 19 in the early

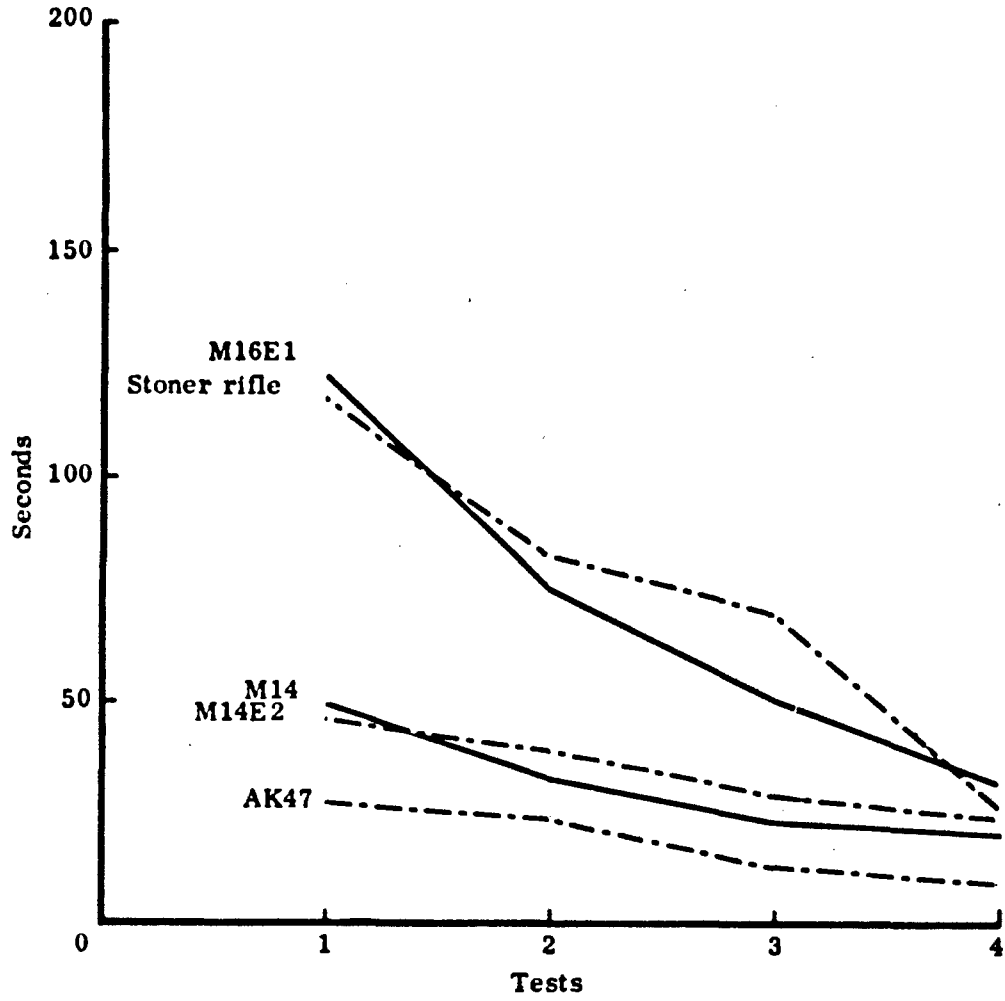

Figure 4-1  
DISASSEMBLY TIME OF RIFLES

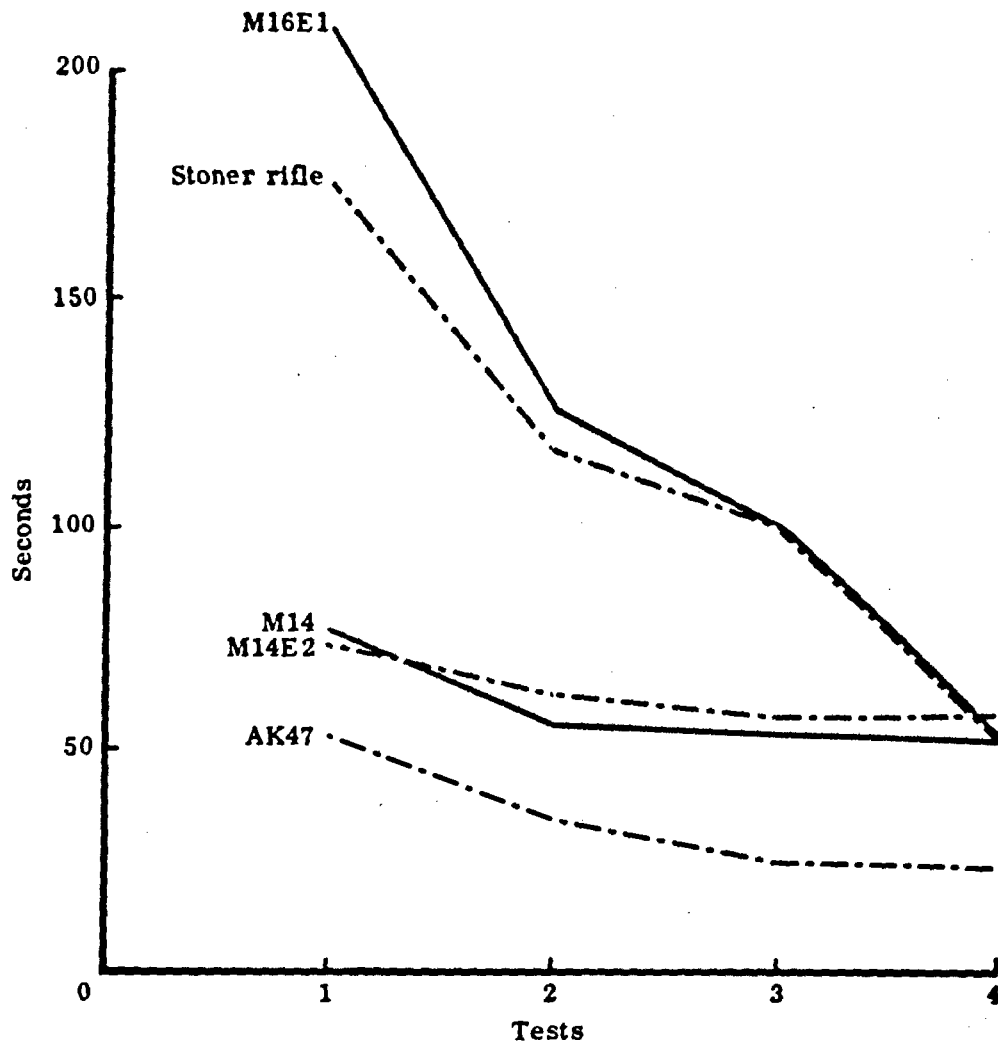

Figure 4-2  
ASSEMBLY TIME OF RIFLES

**Table 4-2  
RIFLE RECORD FIRE QUALIFICATION SCORES**

Weapon	Range	GP	N	Avg	$\sigma$	Date (1965)	Range	GP	N	Avg	$\sigma$	Date (1965)
M14 (128)	19	A	127	45.36	8.99	28 Aug	19	K	60	49.60	8.56	29 Sep
							18	L	55	50.27	8.61	29 Sep
M16E1 (128)	18	B	127	52.66	8.71	28 Aug	19	M	60	54.61	9.11	29 Sep
							18	N	62	56.81	8.16	29 Sep
Stoner (184)	19	C	84	44.45	10.65	7 Sep	19	O	39	48.64	8.54	25 Sep
							18	P	36	52.14	9.09	25 Sep
	18	D	86	54.20	9.48	7 Sep	19	Q	28	51.71	11.74	25 Sep
							18	R	56	54.92	9.83	25 Sep
M14 (56)	19	E	26	48.58	7.63	22 Sep	19	S	14	53.36	6.65	2 Oct
							18	T	12	56.50	6.14	2 Oct
	18	F	27	50.11	7.02	22 Sep	19	U	13	52.77	5.70	2 Oct
							18	V	14	55.93	6.65	2 Oct
M14E2 (72)	19	G	36	52.50	7.48	22 Sep	19	W	18	55.44	7.12	2 Oct
							18	X	17	51.24	9.26	2 Oct
	18	H	36	54.25	10.35	22 Sep	19	Y	16	51.56	5.89	2 Oct
							18	Z	17	57.71	7.53	2 Oct
AK47 (21)	18	I	21	47.38	7.78	22 Sep	19	AA	21	52.57	7.94	2 Oct
AK47 (35)	18	J	39	46.67	8.82	9 Oct	19	BB	34	44.00	7.69	23 Oct

**NOTE:**

Because of different range conditions, weather, and other factors, these scores are not comparable except as discussed in the text.

**CODE:** GP Group Designation  
 N Number of Personnel in Group  
 AV Average Record Score  
 $\sigma$  Standard Deviation

morning did poorly and were seldom able to qualify as experts, regardless of their marksmanship ability or the weapon used.

After the two groups had received equivalent training, the M14 combined group average score (K and L) was 49.4, and the group average score for the Colt rifles (M and N) was 55.71. A level of significance of .001 is attached to this difference. The fact that these Colt rifle scores were higher than the M14 scores is particularly significant when it is considered that, in addition to the SAWS training, the M14 firers had all previously qualified with the M14 and most of them had been using an M14 for more than two years, where the Colt firers first fired the M16E1 during the training period immediately preceding the record firings.

As in the experiment itself, the AK47 scores were low compared to scores of other weapons. This is attributed to the AK47's short barrel (short distance between sights) on the weapons, to varying lots and characteristics of ammunition, to low visibility (fog) conditions on the ranges during the last firing, to the relatively excessive amount of barrel wear of the weapons, and to the fact that the 13 experimental weapons (through 24 December 1965) were shared by all AK47 firers, which necessitated continuous zeroing adjustments. Because both front and rear sights are adjustable this weapon sharing problem may have had more significance for the AK47 than it would have had for other weapons.

### 3. 25 Meter Rifle in Automatic Mode

Each man fired 20 rounds in each of three positions--hip, underarm, and standing. The average number of hits for each weapon group in each position is given in Table 4-3. Two groups of M14 firers and two groups of AK47 firers fired at different times, and their scores are tabulated separately. Scores varied greatly, and the large difference between scores for different groups assigned to the same weapon type is unexplainable. For example, one AK47 group finished first in two of three positions, but the other AK47 group finished last in the same two positions.

### 4. 200 Meter Rifle in the Automatic Mode

Two exercises were repeated three times for this test: in the first, 20 rounds were fired at point targets in 40 seconds; in the second, 30 rounds were fired at point targets in 50 seconds. All firings were in the prone position, but the M14E2, M16E1, and Stoner rifle used their integral bipods, and the M14 and AK47 fired without bipod. Averages for each weapon group in each exercise are given in Table 4-4.

**Table 4-3**  
**AVERAGE NUMBER OF HITS BY RIFLE IN AUTOMATIC MODE**  
**(25-meter Range)**

Weapon	Firing Position						N
	Hip		Underarm		Standing		
	Rank Order	Score	Rank Order	Score	Rank Order	Score	
M14 (sample)	6	2.21	5	3.12	3	9.81	124
M14 (sample)	4	3.46	3	3.44	6	9.56	54
Stoner rifle	2	4.34	2	4.11	1	10.60	160
M16E1	5	2.73	4	3.32	2	10.52	126
M14E2	3	4.12	6	2.41	7	7.60	68
AK47 (sample)	1	5.95	1	4.24	4	9.71	21
AK47 (sample)	7	2.16	7	2.32	5	9.61	38

**Table 4-4**  
**AVERAGE NUMBER OF HITS BY RIFLE IN AUTOMATIC MODE**  
**(200-meter Range)**

Weapon	Exercise 1 <sup>A</sup>			Exercise 2 <sup>A</sup>			N
	1	2	3	1	2	3	
M14 (sample 1) <sup>B</sup>	4.32	3.66	3.68	4.28	4.53	4.49	123
M14 (sample 2) <sup>B</sup>	4.02	3.43	3.22	4.24	4.80	4.76	51
Stoner rifle <sup>C</sup>	6.34	6.60	6.51	8.53	9.05	7.71	166
M16E1 <sup>C</sup>	7.28	7.47	7.43	9.61	9.17	9.22	126
M14E2 <sup>C</sup>	7.30	8.72	9.00	9.71	10.61	10.77	69
AK47 (sample 1) <sup>B</sup>	2.67	2.48	4.33	2.95	4.38	3.95	21
AK47 (sample 2) <sup>B</sup>	2.67	3.26	3.92	4.36	5.05	5.46	39

<sup>A</sup> Two exercises were each run three times. Exercise 1: 20 rounds, 40 seconds. Exercise 2: 30 rounds, 50 seconds.

<sup>B</sup> No bipod

<sup>C</sup> Bipod-supported



## B. AUTOMATIC RIFLE

### 1. Disassembly and Assembly

Four separate tests were conducted exactly like the rifle tests. The times required to complete each test successfully are given in Table 4-5. Trends are similar to trends for the rifle; that is, differences in time were relatively large on the first test, but they narrowed on each succeeding test until they were quite small by the fourth (Figures 4-3 and 4-4). The Stoner weapons showed the longest times and the M14E2 showed the shortest. On Test 4, the Stoner task was performed only up to the carrier cap assembly, which accounts in part for the shorter Stoner times.

### 2. Interim Transition Record

For this test, each weapon was fired in each of three lanes: in Lane 1 (foxhole position), 24 rounds were fired in 28 seconds; in Lane 2 (prone position), 36 rounds were fired in 36 seconds; in Lane 3 (prone), 14 rounds were fired in 28 seconds. Scores were tabulated separately for both hits and targets hit. The averages for each weapon group are given in Table 4-6.

### 3. 25-meter Automatic Rifle

In this test, each man fired 20 rounds in each of two positions (underarm unsupported and hipsling supported). The averages for each weapon are given in Table 4-7.

## C. MACHINEGUN

### 1. Assembly and Disassembly

The four tests used for the rifle and automatic rifle, were repeated for the machinegun. The times and numbers completing the first trial on each of the four tests are given in Table 4-8. The Stoner times were generally the longest for both assembly and disassembly, and the RPD times were the shortest. Also as before, the time differences on the first test were relatively large, but they were reduced as testing progressed. Figures 4-5 and 4-6 indicate the trends.

### 2. Record Firing, Tables II, III, and IV

For this test, each man fired 104 rounds on each table (course). The average number of hits for each of the weapon groups is given in Table 4-9. These results are not comparable because firing conditions for the various groups differed. The RPD and DPM were fired with bipods, and the others with tripods. The second M60 machinegun group and the second Stoner machinegun group consisted of retrained riflemen. This

**Table 4-5  
AUTOMATIC RIFLE  
DISASSEMBLY AND ASSEMBLY TESTS**

<b>Weapon</b>	<b>Test</b>	<b>Average Disassembly Time (Seconds)</b>	<b>Average Assembly Time (Seconds)</b>
<b>M14E2</b>	<b>1</b>	<b>42</b>	<b>59</b>
	<b>2</b>	<b>29</b>	<b>55</b>
	<b>3</b>	<b>27</b>	<b>58</b>
	<b>4</b>	<b>26</b>	<b>50</b>
<b>Colt AR</b>	<b>1</b>	<b>59</b>	<b>108</b>
	<b>2</b>	<b>39</b>	<b>72</b>
	<b>3</b>	<b>36</b>	<b>56</b>
	<b>4</b>	<b>34</b>	<b>61</b>
<b>Stoner AR</b>	<b>1</b>	<b>151</b>	<b>207</b>
	<b>2</b>	<b>117</b>	<b>178</b>
	<b>3</b>	<b>103</b>	<b>154</b>
	<b>4</b>	<b>53</b>	<b>104</b>
<b>Stoner Bipod MG (AR role)</b>	<b>1</b>	<b>162</b>	<b>263</b>
	<b>2</b>	<b>124</b>	<b>185</b>
	<b>3</b>	<b>69</b>	<b>164</b>
	<b>4</b>	<b>56</b>	<b>109</b>
<b>RPD (AR role)</b>	<b>1</b>	<b>43</b>	<b>124</b>
	<b>2</b>	<b>33</b>	<b>90</b>
	<b>3</b>	<b>28</b>	<b>75</b>
	<b>4</b>	<b>31</b>	<b>78</b>
<b>M60 MG (AR role)</b>	<b>1</b>	<b>62</b>	<b>90</b>
	<b>2</b>	<b>52</b>	<b>96</b>
	<b>3</b>	<b>43</b>	<b>75</b>
	<b>4</b>	<b>41</b>	<b>75</b>
<b>RPD (AR role)</b>	<b>1</b>	<b>52</b>	<b>118</b>
	<b>2</b>	<b>42</b>	<b>70</b>
	<b>3</b>	<b>29</b>	<b>71</b>
	<b>4</b>	<b>25</b>	<b>72</b>

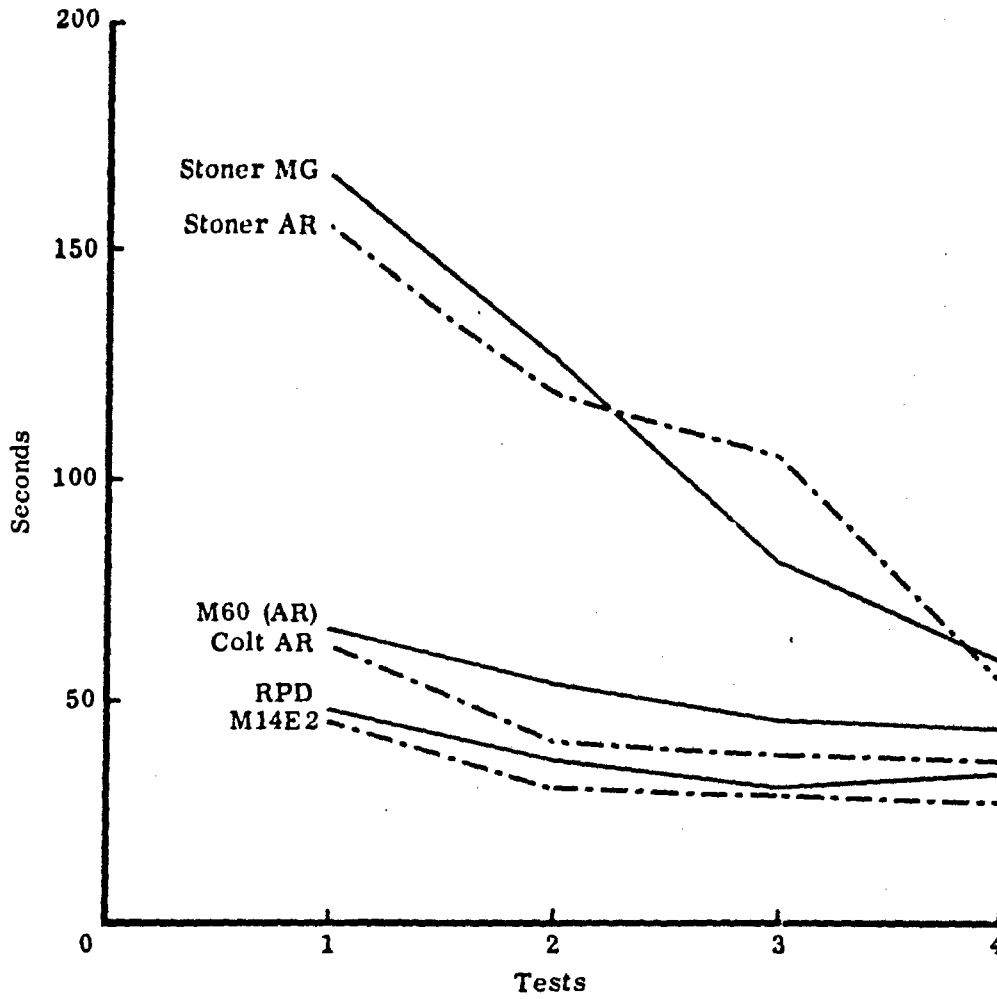

Figure 4-3  
DISASSEMBLY TIME OF AUTOMATIC RIFLES

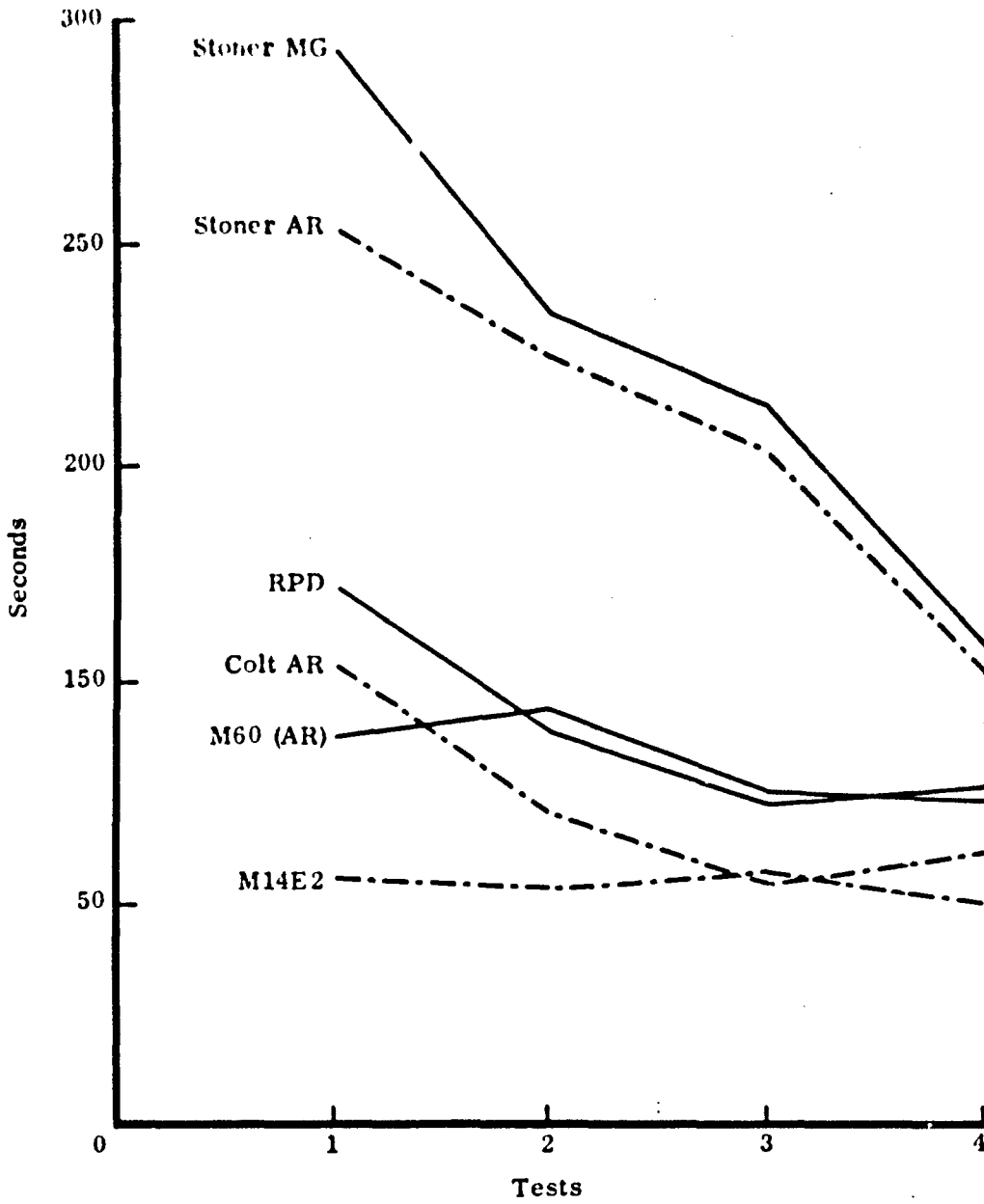

Figure 4-4  
ASSEMBLY TIME OF AUTOMATIC RIFLES

**Table 4-6**  
**AUTOMATIC RIFLE**  
**INTERIM TRANSITION RECORD**

Weapon	Average Hits	Average Targets Hit	N
Colt AR	30.69	11.25	16
M60 (AR role)	26.87	10.87	16
Stoner Bipod MG (AR role)	26.44	10.75	16
M14E2	25.53	10.46	13
RPD (AR role)	23.17	10.10	6
RPD (AR role)	22.00	10.00	10
Stoner AR	21.94	9.94	16

**Table 4-7**  
**AUTOMATIC RIFLE AVERAGE HITS**  
**UNDERARM (UNSUPPORTED) AND HIPSLING POSITIONS**  
**(25-meter Range)**

Weapon	Firing Positions		N
	Underarm	Hipsling	
Colt AR	2.88	1.94	16
M60 (AR role)	3.38	4.44	16
Stoner bipod MG (AR role)	3.75	3.75	16
M14E2	1.56	1.50	16
RPD (AR role)	2.50	3.83	6
RPD (AR role)	2.90	2.70	10
Stoner AR	4.21	3.71	14

**Table 4-8  
MACHINEGUN  
DISASSEMBLY AND ASSEMBLY TESTS**

Weapon	Test	Average Disassembly Time (seconds)	Average Assembly Time (seconds)
Stoner MG (bipod)	1	167	230
	2	138	168
	3	103	126
	4	109	148
Stoner MG (tripod)	1	168	246
	2	90	131
	3	100	134
	4	69	127
M60 MG (bipod)	1	89	115
	2	53	85
	3	46	71
	4	50	75
M60 MG (tripod)	1	95	131
	2	58	85
	3	49	73
	4	49	73
Stoner MG (bipod) Retrained Riflemen	1	113	195
	2	89	174
	3	78	159
	4	75	139
Stoner MG (tripod) Retrained Riflemen	1	99	159
	2	84	133
	3	70	127
	4	65	137
M60 MG (bipod) Retrained Riflemen	1	67	116
	2	70	107
	3	54	84
	4	55	85
M60 MG (tripod) Retrained Riflemen	1	78	106
	2	77	103
	3	54	84
	4	56	82
RPD	1	34	53
	2	35	54
	3	28	53
	4	25	39
DPM	1	68	128
	2	53	89
	3	42	87
	4	32	61

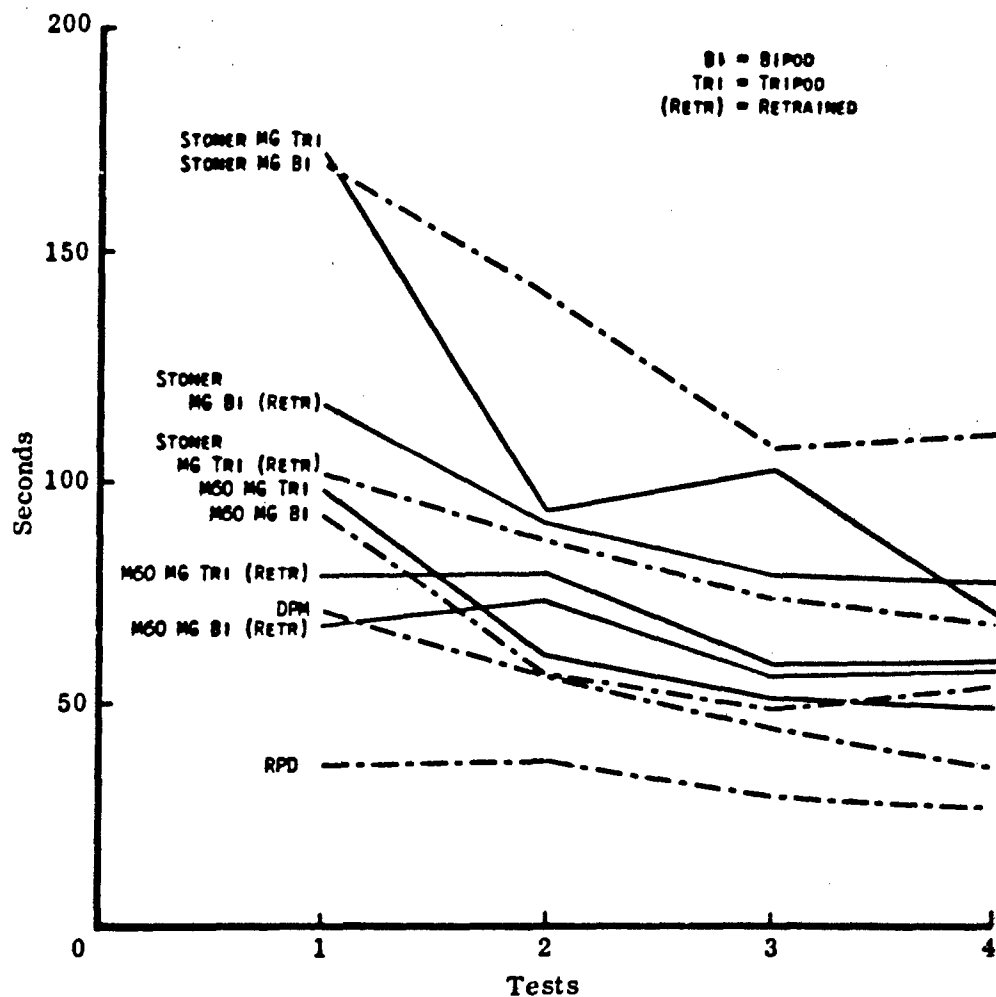

Figure 4-5  
DISASSEMBLY TIME OF MACHINEGUNS

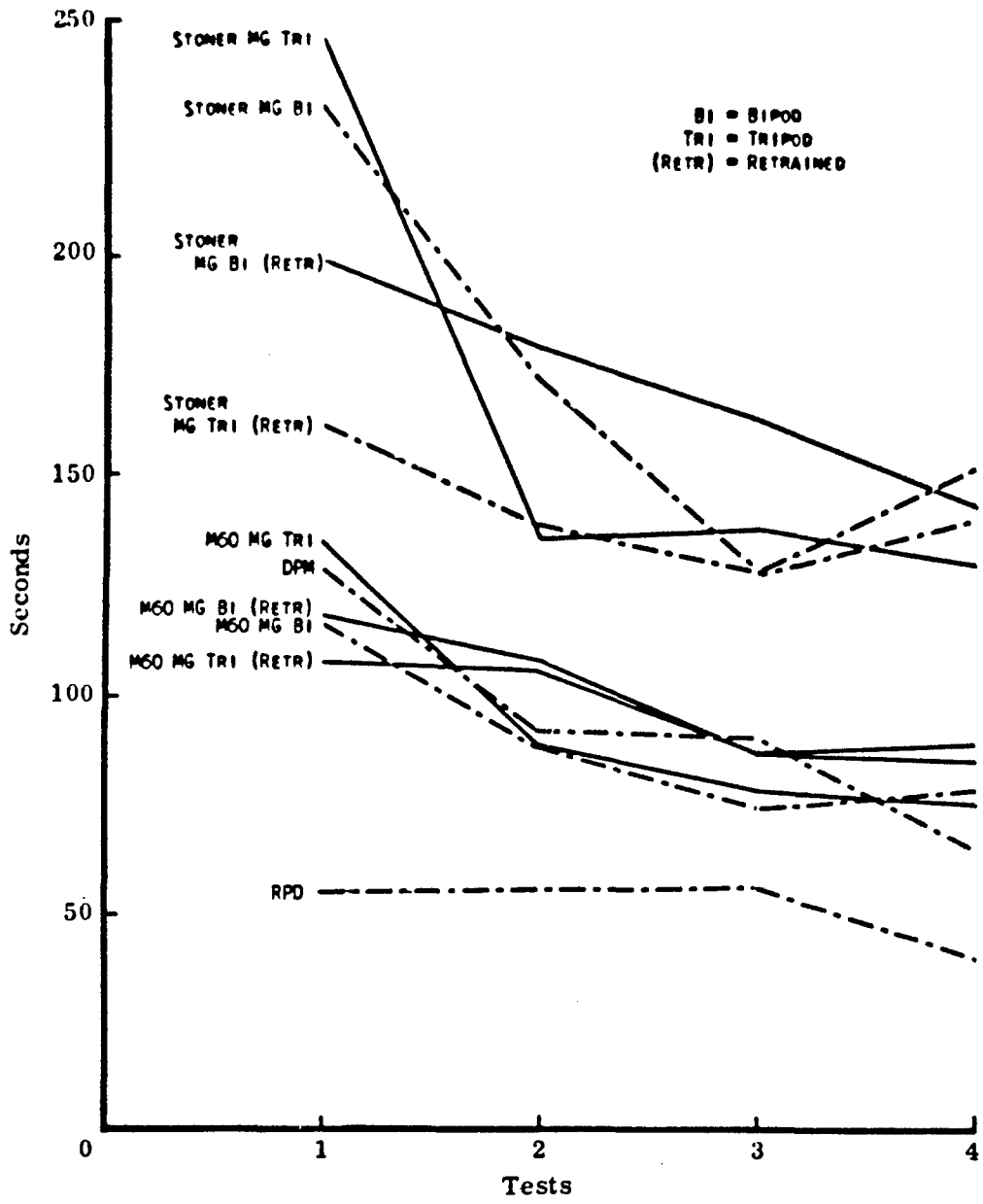

Figure 4-6  
ASSEMBLY TIME OF MACHINEGUNS



**Table 4-9**  
**MACHINEGUN TABLES II, III, IV**  
**AVERAGE NUMBER OF HITS**

Weapon	Table II	Table III	Table IV	N		
				II 32	III 35	IV 33
Stoner MG tripod	64.53	64.64	68.29			
RPD bipod	62.13	68.87	72.40	15		
M60 MG tripod	66.77	70.46	74.20	35		
DPM bipod	57.50	57.25	63.13	8		
M60 tripod Retrained Riflemen	67.33	69.29	75.02	48		
Stoner MG tripod (butt stock) Retrained Riflemen	72.96	73.09	74.38	47		

may have given them a special advantage. In addition, the second Stoner machinegun group fired with buttstocks attached.

**D. CONTAMINATION OF TRAINING SCORES BY WEATHER**

It was recognized before the experiment that weather conditions, particularly light conditions, would affect the firing scores. It was determined from exploratory firing runs with all weapons before the start of training, that these effects were particularly highly correlated with firings against visible point targets where aimed fire was involved, with minimal effects in those situations where area fire was employed.

It was possible during the experimentation runs on the three SAWS experimentation ranges to balance out the schedule of runs so that the same number of squads from each weapon mix ran the same number of times at each time of day. However, during the training phase due to constraints of time, the limited number of range personnel, and limited access to the Fort Ord Training Center ranges, it was not possible, except in rare instances, to balance out weather and time of day effects. Consequently, although training was standardized and although each group received equivalent amounts of training, the record firings on the record ranges are often not comparable.

The effects of time of day and position of the sun are illustrated in Figure 4-7 below. This figure shows the record firing scores of 11 consecutive firing orders of M14 riflemen, the first order having fired at 0800 in the morning and the last order at 1615 in the afternoon. The day was clear and sunny. At 0800 hours, however, for Order No. 1, the sun was in front of the firers, shining behind the targets and into the firers' eyes. On the 1230 hour run, however, the sun was behind the firers. Furthermore, the sun now shone on the front of the targets, and in many instances the targets reflected the sun like a mirror. The difference between the average scores for mixed firing at different times of day was sometimes greater than the difference between the best and worst men within each group. Thus, the difference between the average score of Order No. 1 (37.6) and Order No. 10 (50.8) may not be attributed to any difference in marksmanship ability, but instead must be attributed to differences in visual target acquisition resulting from the position of the sun.

In contrast to Range 19, the effects of visibility on Range 18 are illustrated in Figure 4-8 below. At 0800 hours it was too foggy to see the targets. By 0930 hours, it had cleared enough for range personnel to see the targets and firing was started, but thin fog and haze were still present. The day steadily cleared until for the fourth AK47 order at 1155 hours, all haze had disappeared, and the day was clear and sunny with unlimited visibility.

Following the completion of basic marksmanship training, rifle and machinegun squads were given separate transition training as explained in Section II, paragraph 4B2. The ranges on which this training occurred are presented as follows in diagrammatic form, Figures 4-9 through 4-15.

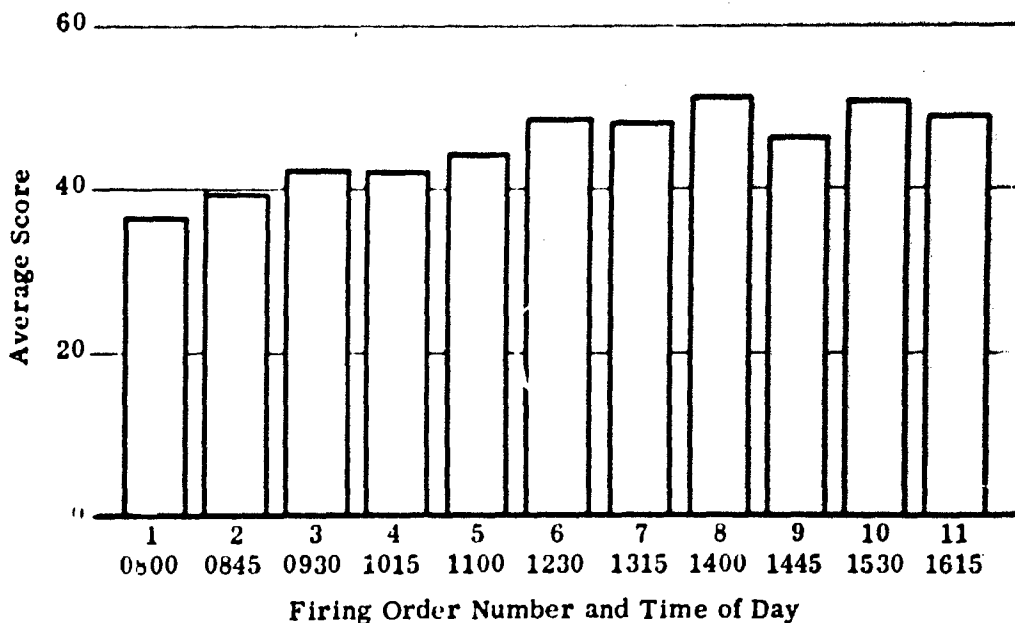

Figure 4-7 RANGE 19 RECORD SCORES AS A FUNCTION OF TIME OF DAY (Position of Sun)

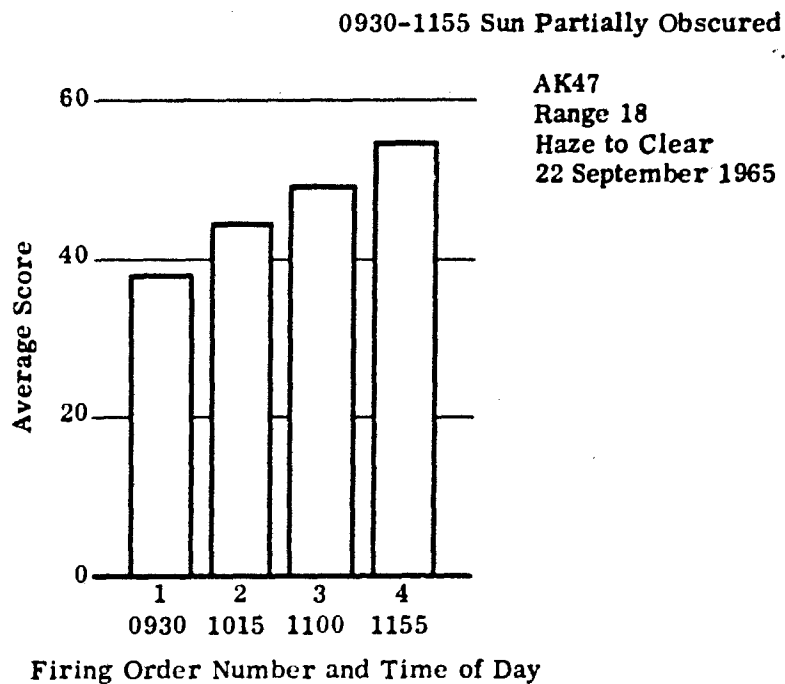

Figure 4-8 RANGE 18 RECORD SCORES AS A FUNCTION OF HAZE CONDITIONS

Rifleman: 10 Rounds  
Automatic Weapons: 20 Rounds

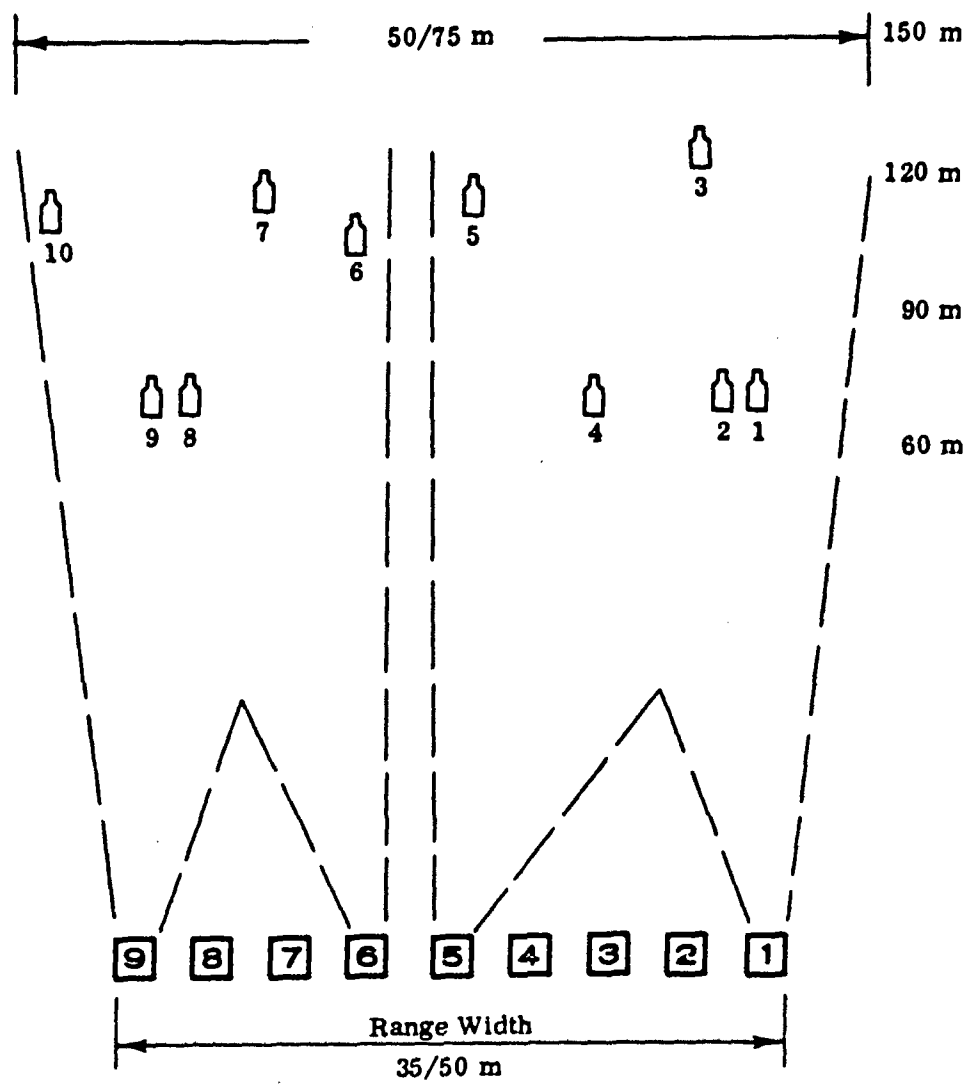

Figure 4-9  
RIFLE SQUAD TECHNIQUE OF FIRE RANGE (Linear Targets)

Rifleman: 10 Rounds  
Automatic Weapons: 20 Rounds

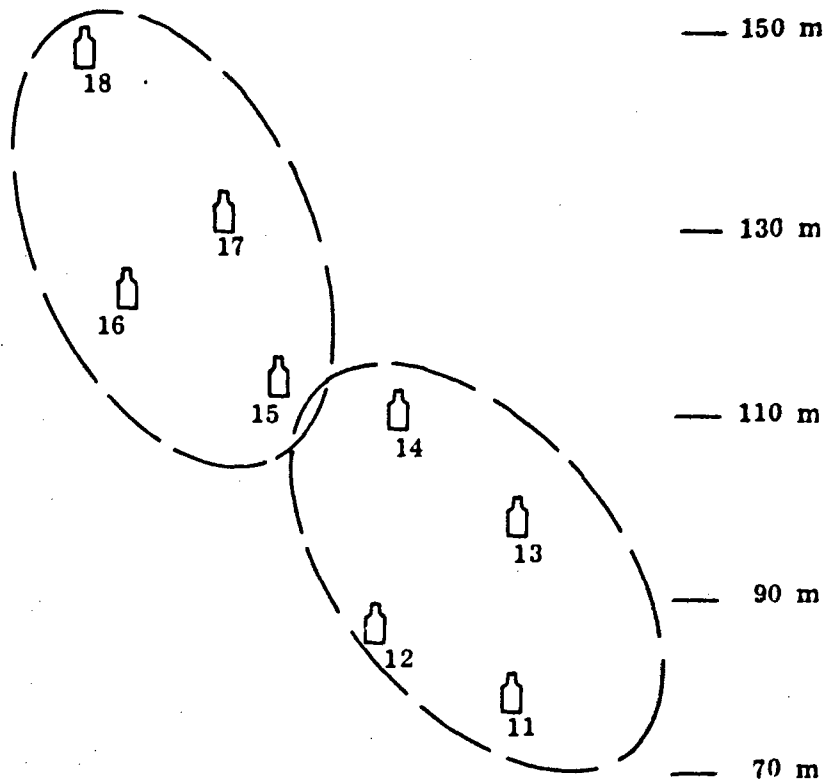

Figure 4-10  
RIFLE SQUAD TECHNIQUE OF FIRE RANGE (Oblique Targets)

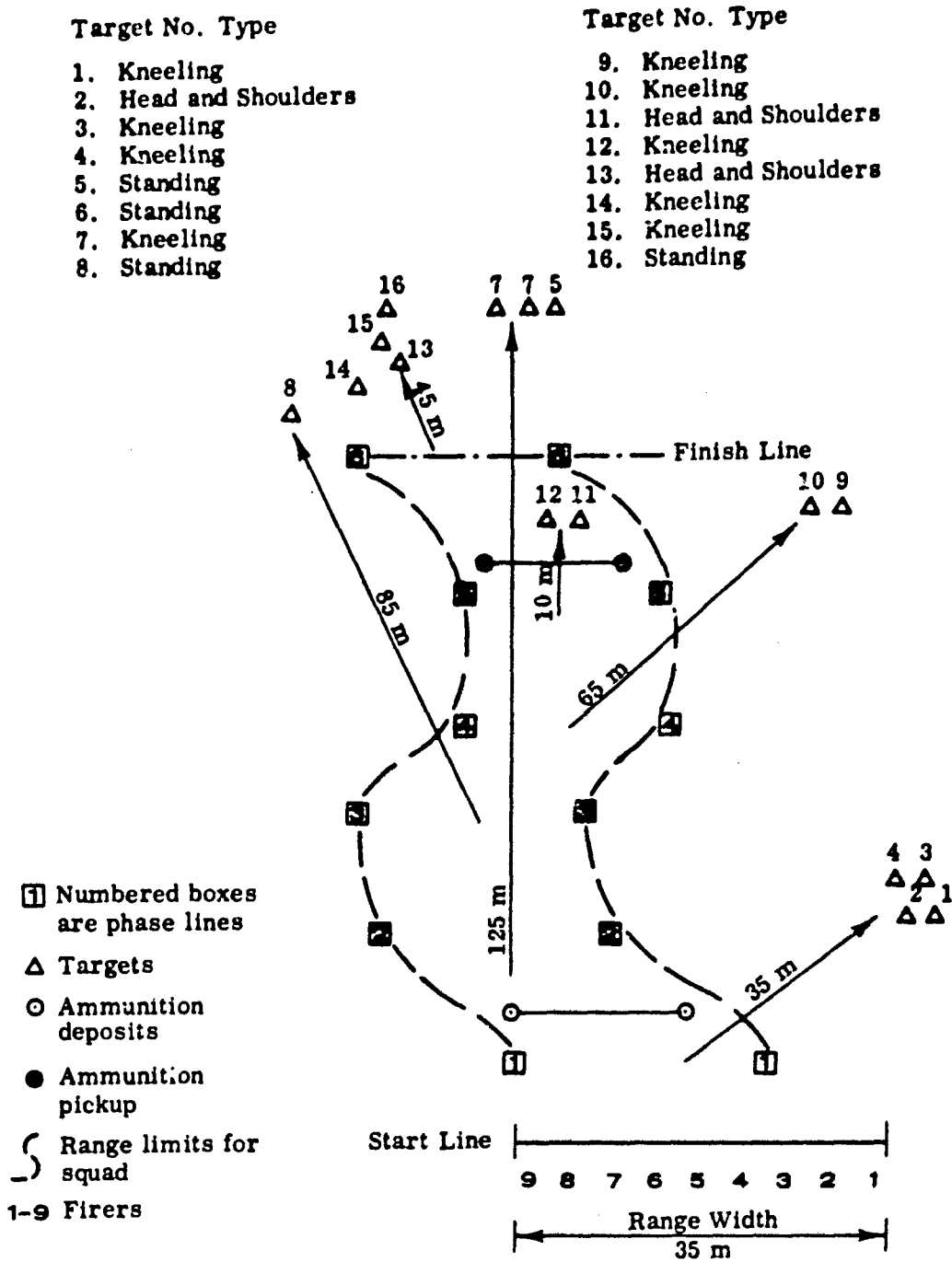

Figure 4-11  
 RIFLE SQUAD IN APPROACH TO CONTACT RANGE

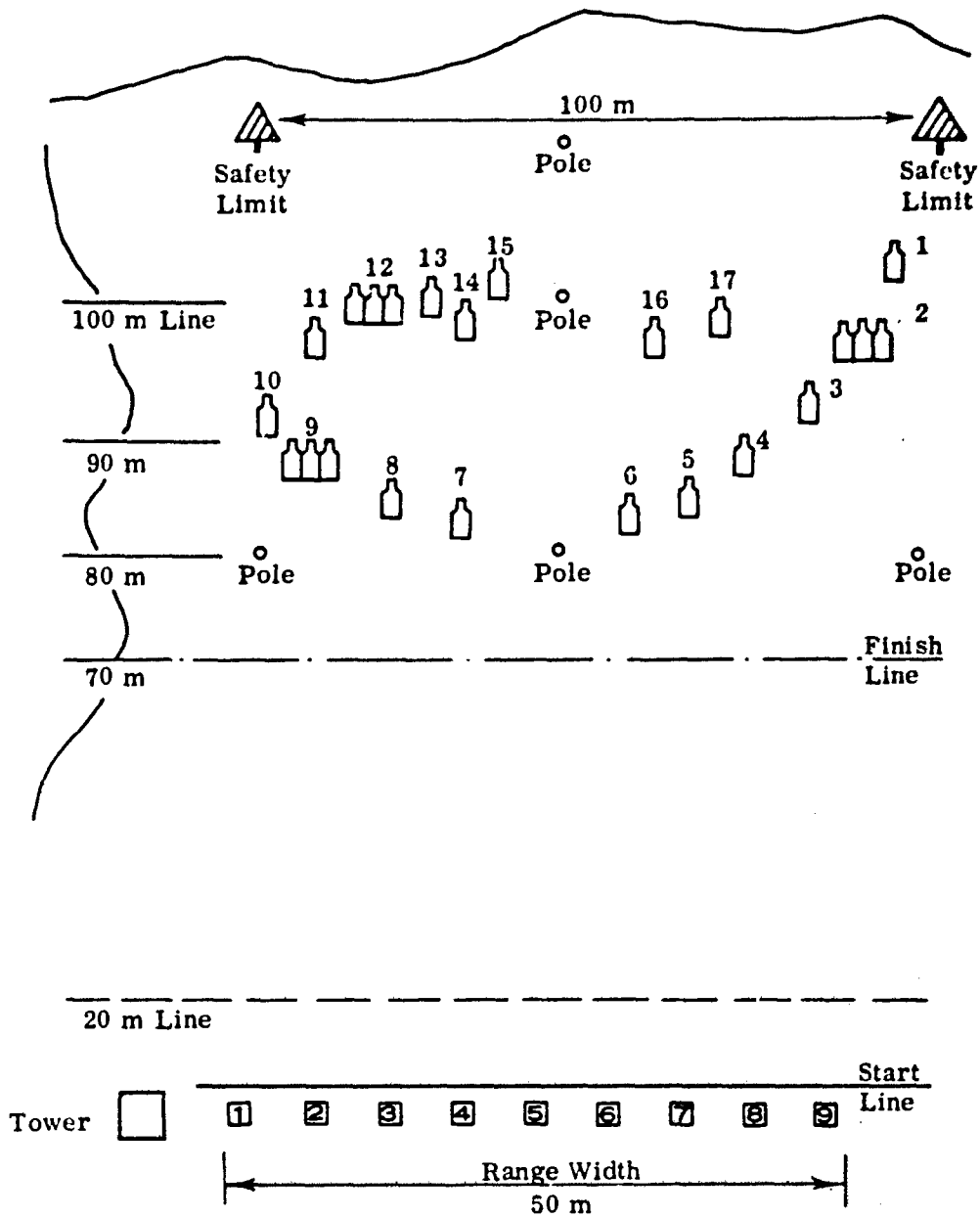

Figure 4-12  
RIFLE SQUAD IN ASSAULT RANGE

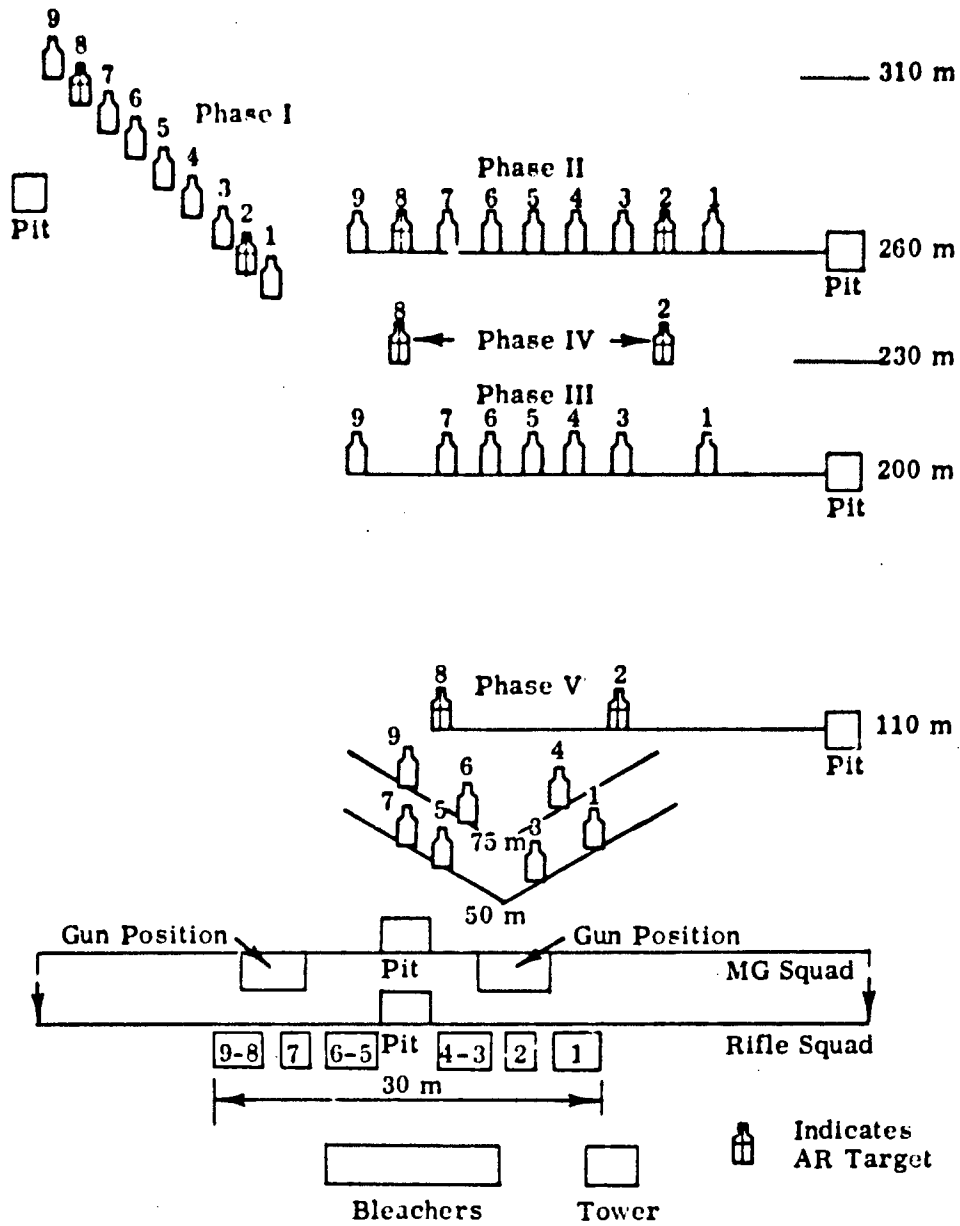

Figure 4-13  
SQUAD IN DEFENSE RANGE (Rifle or Machinegun)



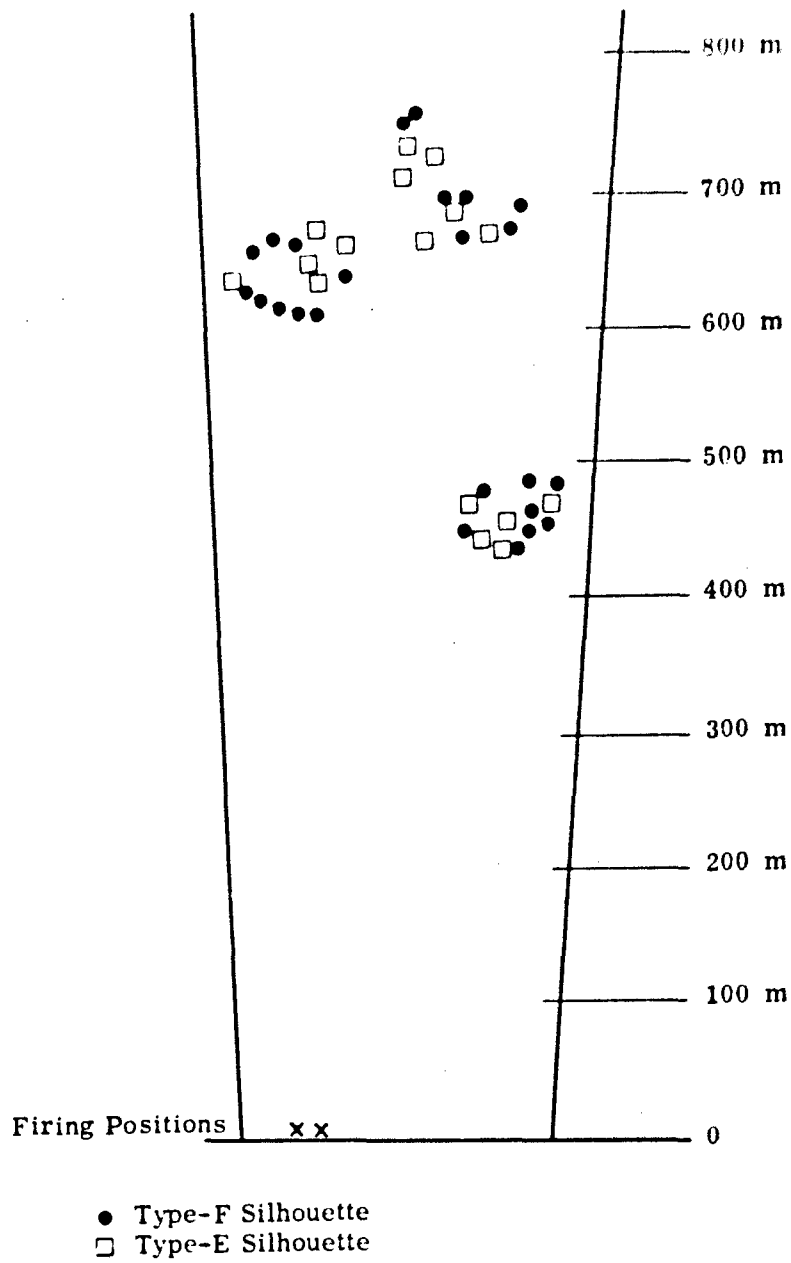

Figure 4-14  
MACHINEGUN SUPPORT OF ATTACK RANGE



- Type-F Silhouettes
- x Firing Position

Figure 4-15  
MACHINEGUN SUPPORT OF ASSAULT RANGE

## SECTION V

### MATERIEL RELIABILITY RESULTS

Reliability results are based on data recorded during training, exploratory, and field experimentation firing (Table 5-1), on investigations made to isolate major causes of malfunctions affecting the experiment, and on observations by technical personnel supervising weapons.

Included are indications of the purpose of reliability data, types of data, methods of collection, and results, including the major causes of malfunctions in certain weapons and the effects of materiel reliability on other results of the experiment.

#### A. PURPOSE OF RELIABILITY DATA

Reliability data were collected and observations were made for the following reasons:

- 1) To meet requirements of the USACDC directive which specified that reliability data be collected
- 2) To provide information and data that would assist in interpreting fire effectiveness data obtained in the experiment; for example, to obtain an indication of the effects of weapon stoppages occurring during the experiment on the level of target effects achieved by different squad weapon mixes
- 3) To assist in making judgments within the SAWS program, regarding the relative reliability of experimentation weapons as to whether there are any fundamental design reasons that might cause one weapon to be less reliable than another\*

---

\* The weapons should not be directly compared on the basis of current reliability performance, because they represent different stages of development and of production experience. For example, the AK47 has been standardized for 18 years and probably more than 15 million have been produced. The M14 has been standardized for eight years and about 1,400,000 have been produced. The M16E1 and M16 have been standardized about two years and about 173,000 have been produced for US military forces. This figure does not include production for foreign or commercial customers. The Colt automatic rifle is a developmental weapon, although an adaptation of the M16E1; and the Stoner weapons are test prototypes.

- 4) To provide detailed reliability data for development, procurement, and logistic agencies for such use as they may have.

## **B. DATA COLLECTED AND OBSERVATIONS**

Detailed reliability data were collected throughout the SAWS experiment--in the training phase, during exploratory firing, and in field experimentation. These data related to malfunctions, time out of action because of stoppages, and replacements of parts and accessories. They were recorded to relate weapon, firer, ammunition lot, weapon zero, rounds fired, trial and trial conditions, and date. Functioning of the weapons and ammunition was also closely observed by supervisory personnel. An attempt was made throughout the experiment to isolate major causes of materiel malfunctions. An AMC technical representative was attached to USACDCEC throughout.

Technical weapon officers and trained armorer artificers supervised the security, safety, maintenance, issue, and troop cleaning of weapons, as well as the storage, inspection, loading of magazines and belts, and issue of ammunition. Weapons were inspected at the time of issue to squads from the storage vans, at the range before the firing run, immediately after the run, after cleaning, and before they were stored again in the van. Two armorer artificers collected reliability data during each squad firing run and debriefed each squad immediately after the run for additional information on malfunctions.

The candidate weapons, ammunition, and spare parts for the experiment were selected and provided by AMC. The weapons, except for the Soviet-types, were in new condition when received by USACDCEC. The ammunition lots provided for the candidate weapons were selected by AMC as typical of ammunition in stock. The Soviet-type weapons were not new, were manufactured in several countries, did not have spare parts (other than by cannibalization), and used a variety of ammunition of varying condition and serviceability.

Data were taken during the experiment on bench rest accuracy of a sample of each weapon-ammunition combination. A summary of these data is given in Annex C.

## **C. RELIABILITY RESULTS AND FINDINGS**

Summary data on malfunctions and stoppages are shown in Table 5-1, by weapon family, weapon, and experiment phase. Further summary of these data, showing malfunctions per thousand rounds fired for each type weapon for the entire experiment and for the field experimentation only, is presented in Table 5-2.

Table 5-1 MALFUNCTIONS A

Malfunctions and Straggles	U.S. Weapons Family									Civil Weapons Family					
	M14			M14E2			M16			M16E1			Auto Rifle		
	A	B	C	D	E	F	G	H	I	J	K	L	M	N	O
	Trg	Expl	Expn	Trg	Expl	Expn	Trg	Expl	Expn	Trg	Expl	Expn	Trg	Expl	Expn
1 Failure to feed	4	11	74	1	2	25	1	3	12	44 <sup>b</sup>	33	199	16	7	120
2 Failure to eject		1	3			1	1	4	46	120	94	1510	2	15	37
3 Failure to extract	1	1	3	1		3	1	4	4	3	27	222		6	1
4 Failure to fire <sup>a</sup>	1	9	66			11	2	1	16	4	33	846		99	143
5 Failure of bolt to remain at rear after firing last round in magazine	2			2	3	2		4		59	169	94	2	21	9
6 Failure of bolt to seat off															
7 Short event										3					
8 Bolt overrode base of round in magazine			2						3	2					
9 Double feed											40 <sup>c</sup>	24	267	14 <sup>b</sup>	74
10 Failure of magazine to lock in rifle											3			1	
11 Failure to remain in assembly	3						9		3	1	1	6		2	
12 Partial stripping of round from link										2					
13 Failure of bolt to lock	1		4									16			1
14 Failure to chamber	3							1	1						4
15 Failure of bolt to go forward			3		2				4			9			
16 Failure of bolt to seat															
17 Bolt jammed	1														
18 Bolt overrode base of round in feeding			5								54	119		23	27
19 Link belt separation									3	11					
20 Failure on closure of bolt			3			2							4		5
21 Bolt catch engaged before last round in magazine was fired			1									4			
22 Total Malfunctions	16	22	164	4	7	44	14	31	104	354	457	2476	55	226	631
23 Total Rounds Fired: Trg Expl Expn	156,549	47,849	116,049	14,165	14,964	79,534	170,336	61,945	95,401	105,313	66,422	265,557	15,324	24,519	104,744
24 Total Rounds Fired <sup>b</sup>	320,527			116,667			327,722			437,692			142,675		
25 Malfunctions per 1000 rounds	.10	.46	1.41	.22	.37	.55	.04	.50	1.09	3.40	6.44	9.32	2.63	9.20	4.30
26 Number of weapons used	120	59	120	22	33	64	44	21	40	120	35	120	16	17	16
27 Average number of rounds fired per weapon	1305	812	964	426	575	1243	1471	2932	2345	474	1909	1213	413	1445	6549

NOTE: Some training and exploratory firing was concurrent with field experimentation.

Trg: Training  
Expl: Exploratory Firing  
Expn: Field Experimentation

<sup>a</sup> Most misfires with U.S. weapons apparently were due to the ammunition.

<sup>b</sup> Eighty-two failures to feed were not attributable to the weapons (they were caused by magazine lips bent in a magazine loader designed for another weapon).

**PPAGES OF WEAPONS**

Stinger Weapons Family								Rocket-Type Weapons								
Virt Rifle				M1				AK47			RPM MP			DPM MP		
R	S	T	L	V	W	X	Y	Z	71	72	73	74	75	76	77	
Expn	Tng	Expl	Expn	Tng	Expl	Expn	Tng	Expl	Expn	Tng	Expl	Expn	Tng	Expl	Expn	
29	3	3	4	27	27	21			24			49		19	114	
44	2	4	3	5	35	71		1	7						4	
49	2	7	1	17	26	138	3	1	74		2	7			4	
57		14	26	73	291	764	4	5		2	2	24	1	135 <sup>a</sup>	43	
90																
		1														
				1		40								1		
		9	16	100	24	47			2						4	
111	1	1	4									1				
							2									
		1		9		3										
						32				4						
7						2			2							
4	2	1	1	1		5		1	1		3				17	
9				53	4	12						1	2			
		4												1		
29																
				143	339 <sup>b</sup>	212 <sup>c</sup>					1	1				
4																
457	12	45	64	549	774	1349	9	4	112	6	10	43	4	149	242	
150,000	13,371	23,342	19,994	122,002	44,922	41,642	84,704	14,091	55,041	54,614	1,424	22,143	14,364	2,302	12,042	
	56,907			252,546			171,476			40,225			28,704			
1.01	.90	1.91	3.30	4.50	15.42	16.52	.09	.44	2.03	.11	7.00	3.74	.24	64.73	20.10	
1.0	16	17	16	44	19	40	26	10	26	7	4	7	3	3	3	
1257	430	1345	1250	2773	2575	2042	3796	1409	2119	4044	337	3149	4754	767	4014	

<sup>a</sup> Rounds of fires not removing magazine when bolt action.

<sup>b</sup> Includes 47 instances of bad primers in ammunition.

<sup>c</sup> Due to faulty manufacture of belt links.

<sup>d</sup> Rounds of fires not removing magazine when applying...

<sup>e</sup> Total rounds fired for the experiment: 2,306,940 with experimentation weapons (an additional 542,547 rounds were expended in nonexperimentation firing).

Table 5-2  
MALFUNCTION RATES

Weapons <sup>A</sup>	Number of Weapons Used	Malfunctions per 1000 Rounds Fired		Average Number of Rounds Fired per Weapon	
		Total Experiment <sup>B</sup>	Field Experimentation Phase	Total Experiment <sup>C</sup>	Field Experimentation Phase
<u>Rifles</u>					
M14	120	0.63	1.41	3,085	968
M16E1	120	7.50	9.32	5,000	2,213
Stoner Rifle	120	1.90	3.03	5,127	1,257
AK47 <sup>D</sup>	26	0.75	2.03	7,724	2,119
<u>Automatic Rifles</u>					
M14E2 <sup>E</sup>	64	0.47	0.55	2,644	1,243
Colt AR	16	4.99	4.30	8,827	6,549
Stoner AR	16	2.16	3.30	3,471	1,250
<u>Machineguns</u>					
M60 MG	40	0.46	1.09	9,208	2,385
Stoner MG	40	10.58	16.52	7,390	2,042
RPD	7	1.23	3.74	11,614	3,169
DPM	3	13.76	20.10	9,569	4,014

<sup>A</sup> All weapons provided for the experiment were new, except the Soviet weapons

<sup>B</sup> Training phase, exploratory firing, and field experimentation

<sup>C</sup> The average number of rounds fired per weapon during the training, exploratory firing, and field experimentation phases

<sup>D</sup> The majority of the AK47 malfunctions occurred after 5000 rounds had been fired during the experiment. Thirteen weapons averaged more than 10,000 rounds apiece. In addition an unknown number of rounds had been fired from the weapons before they were forwarded to USACDCEC. However, the AK47 had significantly fewer malfunctions per weapon than any other weapon at the time it had fired a comparable number of rounds during the experiment.

<sup>E</sup> Includes use as a rifle

Comparative data on parts attrition are shown in Tables C-8 through C-21, Annex C.

The following findings are drawn from the results presented in Tables 5-1, 5-2, and Annex C, with respect to the level of reliability demonstrated in the experiment by candidate and Soviet weapon-ammunition combinations:

- 1) The AK47 was more reliable than any of the other experimentation weapons\*
- 2) The M14, M14E2, and M60 were more reliable than the Stoner and Colt Weapons
- 3) The Stoner machinegun and M16E1 showed the lowest reliability of the candidate weapons
- 4) The Stoner machinegun was least reliable of the candidate weapons, the remaining Stoner weapons ranked after the US 7.62mm weapons but ahead of Colt weapons in reliability

Causes of the principal malfunctions in the weapons are discussed in the following paragraphs.

\* The AK47 averaged 0.75 malfunctions per 1000 rounds fired throughout the entire experiment, based on 26 weapons used after January 1966. However, the majority of firing with the AK47 was done prior to 24 December 1965 with 13 weapons which averaged only .30 malfunctions per 1000 rounds while averaging 8007 rounds fired per weapon at that time. The AK47s were not new, had been manufactured in three different countries (the Soviet Union, East Germany and Red China) and had unknown prior combat and training usage. In addition, there were insufficient spare parts (of the 29 available weapons three were used for spare parts). This lack of weapons and spare parts required an extensive sharing of the AK47s which had an overall average rounds fired of 7724 rounds during the entire experiment compared to only 3085 rounds for the M14. However, the average for the original 13 AK47s was 10,926 rounds per weapon. Although the M14 malfunction rate was 0.63 (0.12 malfunctions per 1000 less than the AK47), many of the M14s had parts replaced with new parts whereas the AK47s were forced to use worn and theoretically unserviceable parts. However, all parts replaced (with used parts from other weapons) were in the original 13 AK47s, and in only one case was a part replaced under 7500 rounds. Because the majority of AK47 malfunctions occurred after 5,000 rounds had been fired and because the weapons had fewer malfunctions per 1,000 rounds when compared with the M14 at the same number of rounds fired, it is concluded that the AK47 is a significantly more reliable weapon than any of the US 7.62mm or 5.56mm weapons.



1. Major Causes of Malfunctions in US 7.62mm Weapons

There were few malfunctions in the US 7.62mm weapons. The 74 failures to feed (Table 5-1, line 1, Column C) in the M14 rifle were attributed to dirty magazines and the magazine follower sticking (through distortion of the magazine spring). The 66 failures to fire were the result of light firing pin indentations in the primer that were considered to be the result of weapons not being completely in battery on activation of the trigger.

2. Major Causes of Malfunctions in 5.56mm Weapons\*

Major causes of most malfunctions in the 5.56mm weapons are attributed to an interaction of ammunition (and belt link) deficiencies:

- 1) Weapon fouling, judged to be caused primarily by qualities of the propellant used in standard ball 5.56mm cartridge
- 2) Cycling of weapons in excess of design rates, judged to be caused by combinations of\*\*:
  - a) Pressure characteristics of the propellant used in the standard ball 5.56mm cartridge
  - b) Factory calibration of M16E1 rifles for a propellant with different pressure characteristics than that in the standard ball 5.56mm cartridge
  - c) Mismatch in internal ballistic (pressure) characteristics between the standard 5.56mm ball and tracer cartridges
- 3) Misfires caused by too low primer sensitivity and possibly (in the case of the Stoner machinegun) an interaction of low primer sensitivity with effects of too rapid weapon cycling caused by the pressure characteristics of the propellant

---

\* These major causes do not account for all the malfunctions experienced by the 5.56mm weapons. For example, early in the experiment the Stoner machinegun had malfunctions caused by improperly fabricated feed trays that were replaced. Accurate attribution of causes for all malfunctions is difficult because some ammunition deficiencies magnified incipient malfunctions.

\*\* Cyclic rates (upper limit) for the M16E1 rifle and Stoner machinegun are 800 and 850 rounds per minute respectively.

4) Incorrectly manufactured machinegun belt links

a. Fouling

Fouling in the 5.56mm weapons occurred throughout the experiment. Dirty chambers resulting from rapid carbon buildup caused most of the failures to extract (see Table 5-1, line 3, columns J through X) and some of the failures to chamber (line 14). Fouling remained a problem throughout the experiment, although cleaning and inspection of weapons were considered more stringent than would be possible during combat.

Inquiry to AMC determined that the propellant adopted for the standard 5.56mm ball cartridge is different from the original propellant used during the development and service testing of the M16E1 rifle and during the development of the Stoner weapons.\* A USACDCEC test of samples from the lot of standard ammunition used in the experiment showed more fouling than an AMC provided sample containing the original propellant. This supplemental fouling test was conducted using ammunition lots WCC 6098 and RA 5074. This limited test firing of 12,620 rounds indicated a malfunctions rate of 5.6 per 1000 rounds for the cartridge loaded with ball propellant as opposed to 0.91 for IMR propellant loaded cartridges. Results of this fouling test are tabulated in Annex C.

b. Excessive Cyclic Rate

Excessive cyclic rates were noted early in the experiment. In addition, surging (uneven firing) was noted when ball and tracer were fired together. There was also an increasing incidence of malfunctions attributed to ammunition cycling the weapons beyond their design rates. The cyclic rates were higher than the design cyclic rates, particularly with the M16E1 rifle and Stoner machinegun.\*\* Surging also was most noticeable with the Stoner machinegun. It is concluded that this excessive cyclic rate (through induced cyclic and impact problems\*\*\*) caused, complicated, and multiplied such malfunctions as failures of the bolt to remain to the rear after the last round was fired from the magazine (see Table 5-1, line 5, columns J through X), failures to eject (line 2, columns J through X), and magazine feeding problems (lines 1, 9, and 18).

---

\* Frankford Arsenal, Tenth Memo Report on AR-15, Rifle/Ammunition System Investigation of Alternate Propellants for Use in 5.56mm M193 Ball Ammunition, dated 15 May 1964

\*\* Cyclic rate of up to 1000 rounds per minute

\*\*\* Impact forces increase with the square of the velocity

A concurrent propellant investigation by Frankford Arsenal showed that the propellant currently used in the 5.56mm ball cartridge cycles weapons faster than the original propellant.\*

Inquiry to AMC determined that, to meet a Government acceptance requirement, M16E1 rifles are calibrated at the factory for the gas port pressure of the original propellant rather than that of the propellant currently used in standard ball 5.56mm cartridges. Interaction of the higher gas port pressure of the current propellant and the sizing of the gas port for a propellant with a lower gas port pressure is considered the reason for the excessive cyclic rate in the M16E1 rifle.

Regarding the excessive cyclic rate and surging of the Stoner machinegun, it was noted that the 5.56mm tracer and ball rounds contained different propellants\*\* and cycled the 5.56mm weapons at different rates: tracer cartridges cycled the weapons at a slower rate than the ball cartridges. It is judged that because of this mismatch the gas port on the Stoner machinegun had to be sized for the slower cycling tracer cartridge to ensure weapons functioning. Since machinegun belt loadings normally are four ball and one tracer, the presence of the faster cyclic ball cartridges causes the gun to cycle above its design rate and to surge as the four faster and the one slower cartridges alternate through the gun. This mismatch also affects the functioning of the other 5.56mm weapons in automatic fire, but to a lesser extent than the machinegun, apparently because of the sustained automatic fire and more frequent use of tracers by the machinegun.

c. Primer Sensitivity

It was reported in a previous test of the Stoner weapons that there had been a high incidence of misfires, particularly in the machinegun\*\*\*. These misfires were attributed by some to an insufficient primer sensitivity of the 5.56mm cartridge and by others to a lack of sufficient recoil power in the Stoner machinegun. However, if these misfires were due to insufficient recoil power and if the sensitivity of the cartridge primer was not marginal, then misfires with the 5.56mm cartridge would tend to be limited to the machinegun. This was not the case in the SAWS experiment. After

---

\* USACDC Liaison Office, USA Weapons Command, Rock Island, Illinois, Liaison Report 385-65, 27 December 1965.

\*\* Copies of Ammunition Lot Inspection sheets furnished by AMC to USACDCEC to show that the ball ammunition furnished contains ball propellant (WC846) and that the tracer ammunition furnished contains IMR type propellant (CR 8136 and EX 8136).

\*\*\* Stoner 63 Weapon System Final Report, Project No. 44-63-08 of 29 April 1965, Marine Corps Landing Force Development Center, MCS, Quantico, Virginia, page 17.

It was decided that the ammunition was causing the machinegun to misfire and cycle at an abnormal rate, it was also decided that a reduction in the buffer preload resulting from the pounding of the buffer might reduce firing pin energy. It was indicated that this in turn might cause the rate of misfires to increase sharply after the weapons had been fired in heavy sustained fire, especially if primer sensitivity were marginal. Inquiry to AMC disclosed that there had been a decrease\* in primer sensitivity at the time of standardization of the 5.56mm ball cartridge, to overcome what was then considered a tendency of the round to fire on closure of the bolt in the M16E1 (then AR15) rifle. It was therefore desirable to examine the primer indentations of misfire cartridges. Therefore, provisions also were made to collect data regarding any instances of primers being too sensitive: that is, rounds firing when the bolt was closed without pulling the trigger. With respect to these points, the experiment produced the following information:

- 1) In 1,261,215 rounds fired by the 5.56mm weapons, there were no instances of cartridges firing when the bolt was closed without pulling the trigger and no cases where the primer indentations of misfire cartridges were sufficiently shallow to have clearly caused misfires.
- 2) Misfires occurred with all five of the 5.56mm weapons (see Table 5-1, line 4, columns J through X), rather than only with the Stoner machinegun. The four weapons other than the machinegun incurred 829 misfires in 1,008,629 rounds fired, or one per 1217 rounds.
- 3) Of the 1132 misfires experienced with the Stoner machinegun during the experimentation, 472 occurred during later sustained machinegun fire (Situations 3, 6, and 9). This could have been due to the reduction in the buffer preload, to the reuse of the belt links, or to some other cause. Measurements of the buffer taken after the completion of Situations 3, 6, and 9 showed that preloads were below the design minimum.\*\*

---

\* Primer sensitivity was decreased from "no fire" at 6 inch-ounces and "all fire" at 36 inch-ounces, to "no fire" at 12 inch-ounces and "all fire" at 48 inch-ounces. Ref: Frankford Arsenal - 1st Memo Report on AR15 Rifle Ammunition Systems, Investigation of Firing Pin Energy and Primer Sensitivity, data 4 April 1963 and Military Specification MIL-C-996-3D, dated 1 June 1964.

\*\* The preload specification is 245 pounds minimum and 260 pounds maximum. The average preload after firing Situations 3, 6, and 9, was 221 pounds.

This information therefore indicates that misfires in the 5.56mm weapons were due to the function of primers that were too insensitive.

d. Belt Links

During the experiment, it was noted that a major cause of Stoner machinegun malfunctions was belt link separations. Separations occurred as often as ten times per belt, frequently causing other malfunctions.

Comparisons of the links against design drawings showed that the links deviated from design drawings dimensions. At USACDCEC request, 30,000 links made to design drawing dimensions were obtained from AMC. A comparison test of the "old" and "new" links produced the following results.

An average of seven separations per belt occurred when eight belts of 150 rounds were fired, each using the old links. The number of separations by belt were 8, 3, 18, 5, 8, 0, and 7. These separations also caused 24 failures to feed, one failure to strip (stuffed round resulted), and two failures of bolt to go forward. No separations occurred with the new links when firing with seven 150-round belts and one 200-round belt. The 200-round belt had links that were used a second time.

The 30,000 links manufactured to proper design were then substituted for the originally supplied links for the machinegun squad portion of the experiment (Situations 3, 6, and 9). \* During this phase of the experiment (in which 28,000 rounds were fired) there were three belt separations, and these separations occurred with links that had been reused.

e. Other Ammunition Deficiencies

Although individuals adjacent to the firer normally could see both tracers, neither the US 7.62mm tracer cartridge nor the US 5.56mm tracer cartridge provided a trace that was visible enough to be used by the firer in adjusting fire, with or without sights, under daylight conditions. This deficiency negates the adjustment of fire for automatic weapons by the gunner observing his tracers.

The US 7.62mm duplex cartridge suffered pierced primers. This was judged to be caused by excessive chamber pressure. \*\*

---

\* Faulty type links already had been used with the Stoner machineguns throughout four of the six situations in the rifle squad portion of the experiment.

\*\* Current chamber pressure, temperature, and waterproofing deficiencies of this cartridge are given in Memorandum Report, Preproduction Test of Cartridge, 7.62mm, Ball, Duplex, M198, April 1965, Frankford Arsenal

#### **D. EFFECT OF MALFUNCTIONS ON EXPERIMENTATION**

Malfunctions in the 5.56mm weapons attributed to faulty ammunition and belt links degraded the fire effectiveness of all 5.56mm weapons, especially the M16E1 rifle and Stoner machinegun. In one tactical situation, for example, the M16E1 rifle had a weapon downtime due to stoppages of 6.97 percent of the situation time. The effects on the Stoner machinegun were judged to be sufficiently severe to disqualify the machinegun squad portion of the experiment.

The AK47 was the most reliable of the experimentation weapons. The US 7.62mm weapons (M14, M14E2, and M60) demonstrated fewer malfunctions than the US 5.56mm weapons. The Stoner machinegun and M16E1 had the highest malfunction rate. The reliability of the Stoner machinegun with the ammunition provided for the experiment was judged to be sufficiently low to invalidate the machinegun squad portion of the experiment. Major causes of malfunctions in the 5.56mm weapons were attributed to:

- 1) An interaction of ammunition deficiencies caused by changes made in the ammunition propellant and primer sensitivity at the time of the standardization of the 5.56mm ball cartridge
- 2) Deviations from design specifications in the manufacture of the machinegun belt links

Until the deficiencies in the ammunition and belt links are corrected (and it is considered that they are readily correctable), it is impossible for the Stoner 5.56mm machinegun to function at its maximum potential.

Neither 7.62mm nor 5.56mm tracer rounds provide a trace that is visible enough to the firer under daylight conditions for him to use it in adjusting his fire. The duplex round suffered pierced primers, apparently caused by excessive chamber pressure in the M14 and M14E2 rifles.

## SECTION VI

### SQUAD WEAPON MIX FIRE EFFECTIVENESS RESULTS

#### A. RIFLE SQUAD EXPERIMENT

The results are presented on foldout sheets and in separate tables and graphs for each situation. Included are raw score averages, standard scores, probability (p) values, F values,  $X^2$  values, ranges of scores for the measures of effectiveness and collateral measures, graphs of hits as a function of time and range where applicable, and histograms for the distribution of near misses by target where applicable.

The results for Mix RC (seven AK47 rifles and two RPD machineguns) are not included in the same tables and graphs as other mixes. Mix RC was fired later (January 1966). Because of differences in range conditions and weather, the RC results are not directly comparable to the other rifle squad mix results and are therefore presented separately.

##### 1. Situation 1: Rifle Squad in Line Assault

This situation evaluated rifle squad mixes in marching fire against concealed and partially concealed enemy targets in foxholes. The length of the assault was 100 meters, and the duration was 2 minutes. Enemy targets were engaged 115 to 148 meters from the line at which the assault started, and at distances of 15 to 48 meters from the point where the assault ended. The target array occupied a position 50 meters wide and 30 meters deep with a differential in target elevations of about 4 meters.

Results for the assault are tabulated and presented graphically in Figure 6-1.

The average number of near misses for all mixes combined are presented as a function of target location and simulator type in Figure 6-2. This figure presents the vertical profile of the target array showing to scale the elevation and width of the array. The position of each target is shown. Because the assault is progressing up a slope, the difference in the elevation of the actual targets as seen by the firers is less than that shown in the figure. The number associated with each target on the profile shows the average number of near misses for all rifle mixes, the simulator cues associated with each target, and the width of the near miss zone at each target. Although not shown, the height of the near miss sensing zone extends in a 2-meter semicircle from the center of the target.

The tabulation below indicates the approximate distance of the squad from the middle of the target array (in depth and width) in relation to the time in minutes that the squad progressed up the assault course. Exploratory firings on the assault range indicated that squad movement across the assault range was generally at a constant rate. All squads took approximately 2 minutes to complete the course.

Time Traveled (minutes)	Average Distance from Targets (meters)
.00	131
.25	119
.50	105
.75	94
1.00	81
1.25	69
1.50	56
1.75	44
2.00	31

Figure 6-3 illustrate the average number of targets hit and average number of near misses plotted as a function of time and range for each mix in the assault situation. The cumulative average hits by each mix at each point along the assault course are indicated by the ordinates of the curve at that point. The start of the assault (131 meters from the targets) is indicated by the left end of the curve and the completion of the assault (31 meters from the targets) is indicated by the right end of the curve.

Figure 6-4 shows the number of near misses for each target and their distribution as a function of target location and simulator type. Target locations are provided for purposes of comparison in insert maps.

The rank order of weapon mixes (other than Mix RC) with associated standard scores are presented below.



Target Effects Only			Overall Effectiveness*		
Rank	Mix	Standard Score	Rank	Mix	Standard Score
1	SB	70.1	1	CB	65.8
2	SA	68.9	2	SB	65.6
3	SC	65.2	3	SA	63.5
4	UB	59.8	4	CA	59.7
5	CB	57.9	5	SC	56.2
6	CA	47.1	6	UB	54.4
7	UA	42.2	7	UA	43.8
8	RA	35.7	8	RA	35.3
9	UD	28.2	9	UD	32.4
10	UC	25.9	10	UC	24.3

\* Sustainability weighted 1/3; Target effects 2/3

**Key:**

- |                                     |   |
|-------------------------------------|---|
| UA - 9 M14 Rifles                   | SB - 7 Stoner Rifles and<br>2 Stoner AR |
| UD - 9 M14E2 Rifles                 | SC - 7 Stoner Rifles and<br>2 Stoner MG |
| UB - 7 M14 Rifles and<br>2 M14E2 AR | CA - 9 Colt Rifles                      |
| UC - 5 M14 Rifles and<br>2 M60 MG   | CB - 7 Colt Rifles and<br>2 Colt AR     |
| SA - 9 Stoner Rifles                | RA - 9 AK47 Rifles                      |

Mix RC results for Situation 1 are presented below.

CET	Near Misses	Percent Ammo Remaining	Targets Hit	Total Hits
29.08	3.67	25	2.4	2.4

EFFECTIVENESS MEASURES

COLLATERAL PERFORMANCE MEASURES

Cumulative Exposure Times

Mix	$\bar{X}$ CET	SD	Standard Score z'
UB	24.1	2.4	81.8
SB	24.4	1.7	73.4
SA	24.8	1.9	64.1
CB	25.1	2.0	56.3
SC	25.3	2.1	49.6
UA	25.5	1.2	47.2
UD	25.5	1.9	44.8
CA	25.8	1.4	38.2
RA	26.1	0.8	31.5
UC	26.8	2.4	14.9
$\bar{X}$	25.32		
SD	.80		

Number of Near Misses

Mix	$\bar{X}$ Near Misses	SD	Standard Score z'
SC	499.6	114.0	80.8
SA	469.8	68.9	73.8
SB	439.5	92.1	66.7
CB	409.2	89.6	59.6
CA	393.8	83.1	56.0
RA	324.4	26.1	39.8
UB	315.5	73.2	37.7
UA	312.8	59.4	37.1
UC	312.3	49.2	37.0
UD	203.3	30.4	11.5
$\bar{X}$	368.03		
SD	85.49		

Sustainability (% Ammo Remaining)

Mix	$\bar{X}$ % Remaining	SD	Standard Score z'
CA	72.2	5.2	85.0
CB	69.9	3.5	81.4
SB	52.8	6.0	56.4
SA	51.1	8.2	52.7
UA	47.5	6.7	47.3
UB	45.2	11.9	43.8
UD	43.4	10.3	41.0
SC	41.3	8.3	37.8
RA	39.2	2.9	34.6
UC	30.3	9.5	21.0
$\bar{X}$	49.29		
SD	13.10		

Number of Targets Hit

Mix	$\bar{X}$ Targets Hit	SD	Standard Score z'
UB	5.1	1.8	79.3
SB	4.7	2.0	69.5
SA	4.4	0.8	62.4
CB	4.2	2.5	57.6
UA	4.0	1.1	53.8
SC	4.0	2.1	53.6
RA	3.1	1.7	31.9
CA	3.0	2.0	29.8
UD	2.9	1.4	27.4
UC	2.9	2.0	26.7
$\bar{X}$	3.86		
SD	.04		

Total Hits

Mix	$\bar{X}$ Hits
SB	5.2
UB	5.1
SA	4.5
CB	4.5
SC	4.4
UA	4.1
RA	3.1
UC	3.1
CA	3.0
UD	2.9
$\bar{X}$	3.98
SD	.887

Target Effects

Mix	Standard Score Target Effects
SB	70.05
SA	68.95
SC	63.20
UB	59.75
CB	57.95
CA	47.10
UA	42.15
RA	35.65
UD	28.15
UC	25.95

Overall Effectiveness

Mix	Overall Fire Effectiveness
CB	65.77
SB	65.50
SA	63.53
CA	59.73
SC	56.17
UB	54.43
UA	43.87
RA	35.30
UD	32.43
UC	24.30

Cumulative Exposure Time

	UB	SB	SA	CB	SC	UA	UD	CA	RA	UC
UB		.39	.26	.22	.19	.12	.13	.08	.05	.04
SB			.32	.29	.22	.12	.14	.07	.04	.04
SA				.38	.29	.16	.20	.09	.02	.05
CB					>.40	.35	.34	.24	.16	.11
SC						>.40	>.40	.34	.25	.17
UA							>.40	.33	.17	.14
UD								>.40	.28	.18
CA									.35	.21
RA										.29

Number of Near Misses

	SC	SA	SB	CB	CA	RA	UB	UC
SC		.30	.18	.09	.06	.005	.005	.04
SA			.27	.11	.06	.002	.003	.04
SB				.29	.19	.02	.02	.04
CB					.38	.04	.04	.04
CA						.06	.06	.04
RA							>.40	.04
UB								>.40
UC								

Sustainability (% Ammo Remaining)

	CA	CB	SB	SA	UA	UB	UD	SC	RA	UC
CA		.19	.000	.000	.000	.000	.000	.000	.001	.000
CB			.000	.000	.000	.000	.000	.000	.001	.000
SB				.35	.09	.10	.04	.02	.001	.000
SA					.21	.17	.09	.04	.009	.002
UA						.35	.22	.10	.02	.004
UB							.39	.28	.15	.02
UD								.36	.20	.02
SC									.31	.04
RA										.04

No. of Targets Hit

	UB	SB	SA	CB	UA	SC	RA	CA	UD	UC
UB		.36	.20	.25	.13	.19	.05	.04	.02	.04
SB			.37	.36	.25	.30	.10	.09	.05	.08
SA				>.40	.27	.34	.06	.07	.02	.06
CB					>.40	>.40	.22	.20	.15	.18
UA						>.40	.15	.15	.08	.13
SC							.23	.22	.16	.19
RA								>.40	>.40	>.40
CA									>.40	>.40
UD										>.40

Total Hits on Targets

	SB	UB	SA	CB	SC	UA	RA	UC
SB		>.40	.20	.34	.25	.09	.03	.04
UB			.26	.36	.28	.13	.04	.04
SA				>.40	>.40	.19	.04	.04
CB					>.40	.36	.19	.04
SC						.37	.16	.04
UA							.14	.04
RA								.04
UC								.04
CA								.04

Note: Standard Scores computed from raw scores using scores to three decimal places.

UA - 9 M14 Rifles  
 UB - 7 M14 Rifles/2 M14E2 AR  
 UC - 5 M14 Rifles/2 M60 MG  
 UD - 9 M14E2 Rifles  
 CA - 9 Colt Rifles

CB - 7 Colt Rifles/2 Colt AR  
 SA - 9 Stoner Rifles  
 SB - 7 Stoner Rifles/2 Stoner AR  
 SC - 7 Stoner Rifles/2 Stoner MG  
 RA - 9 AK47 Rifles

$\bar{X}$  - Mean (Average)  
 SD - Standard Deviation  
 CET - Cumulative Exposure Time  
 z' - Standard Score ( $X - \bar{X} / SD$ )

COLLATERAL PERFORMANCE MEASURES

Number of Targets Hit				Total Hits on Targets			
MIX	$\bar{X}$ Targets Hit	SD	Standard Score z'	MIX	$\bar{X}$ Hits	SD	Standard Score z'
UB	5.1	1.8	79.3	SB	5.2	2.1	76.5
SB	4.7	2.0	69.5	UB	5.1	1.8	75.1
SA	4.4	0.8	62.4	SA	4.5	0.8	62.7
CB	4.2	2.5	57.6	CB	4.5	3.2	62.3
UA	4.0	1.1	53.8	SC	4.4	2.1	58.9
SC	4.0	2.1	53.6	UA	4.1	1.1	51.0
RA	3.1	1.7	31.9	RA	3.1	1.5	30.2
CA	3.0	2.0	29.8	UC	3.1	2.0	29.1
UD	2.9	1.4	27.4	CA	3.0	2.0	28.2
UC	2.9	2.0	26.7	UD	2.9	1.4	26.0
$\bar{X}$	3.86			$\bar{X}$	3.98		
SD	.84			SD	.887		

Number of Near Misses

UC	SC	SA	SB	CB	CA	RA	UB	UA	UC	UD
.04 SC		.30	.18	.09	.06	.035	.005	.004	.004	.001
.04 SA			.27	.11	.06	.002	.003	.002	.001	.001
.05 SB				.29	.19	.02	.02	.01	.009	.001
.11 CB					.38	.04	.04	.03	.02	.001
.17 CA						.06	.06	.04	.04	.001
.14 RA							.40	.35	.32	.001
.18 UB								.40	.40	.004
.21 UA									.40	.002
.29 UC										.001

Total Hits on Targets

UC	SB	UB	SA	CB	SC	UA	RA	UC	CA	UD
.04 SB		>.40	.20	.34	.25	.09	.03	.04	.03	.02
.08 UB			.26	.36	.28	.13	.04	.05	.04	.02
.06 SA				>.40	>.40	.19	.04	.06	.05	.02
.18 CB					>.40	.36	.19	.18	.18	.14
.13 SC						.37	.16	.16	.15	.10
.19 UA							.14	.16	.15	.08
.40 RA								>.40	>.40	>.40
.40 UC									>.40	>.40
.40 CA										>.40

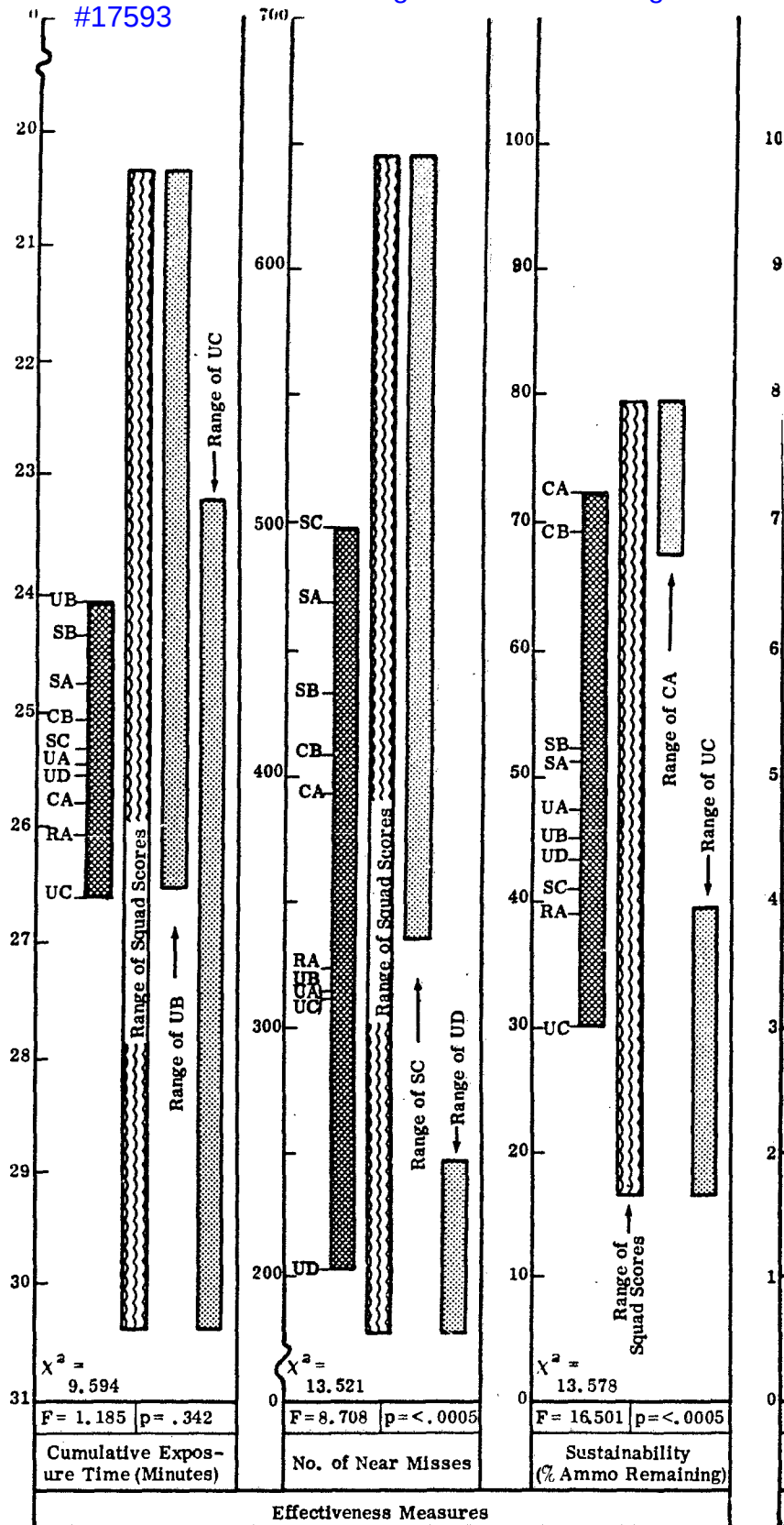

1/2 Colt AR  
 1/2 Stoner AR  
 1/2 Stoner MG  
 $\bar{X}$  - Mean (Average)  
 SD - Standard Deviation  
 CET - Cumulative Exposure Time  
 z' - Standard Score ( $\bar{X} = 50$ ,  $SD = 20$ )

Figure 6-1 SUMMARY OF RESULTS--

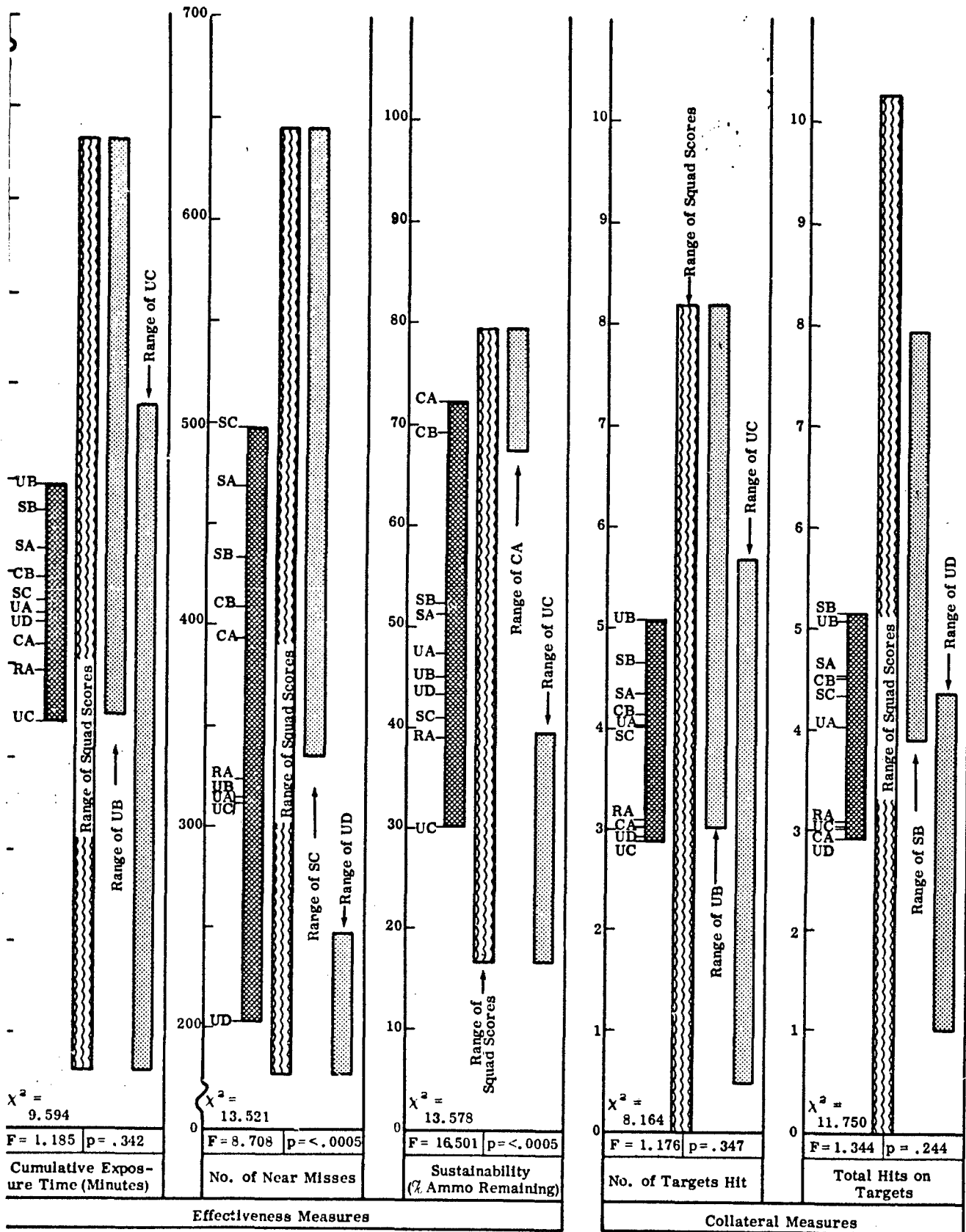

Figure 6-1 SUMMARY OF RESULTS--SITUATION 1

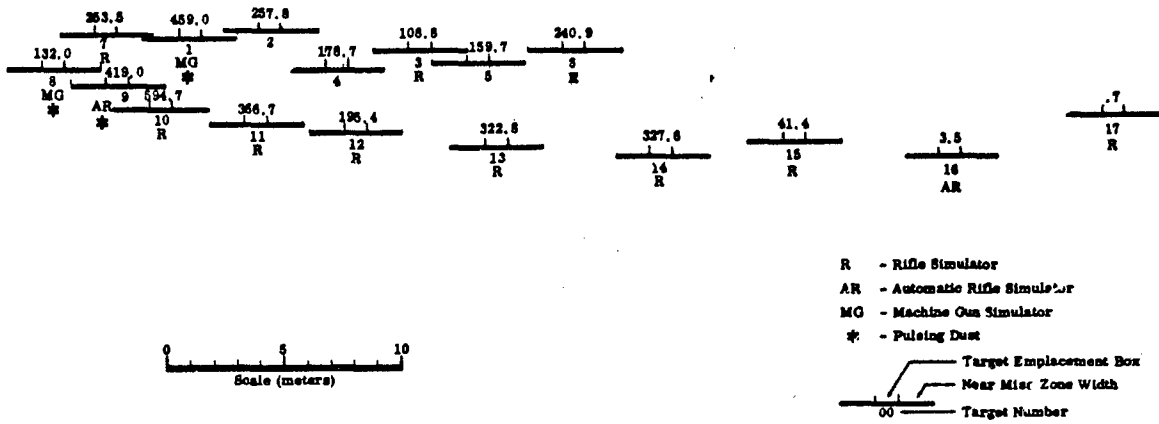

Figure 6-2  
VERTICAL PROFILE--SITUATION 1

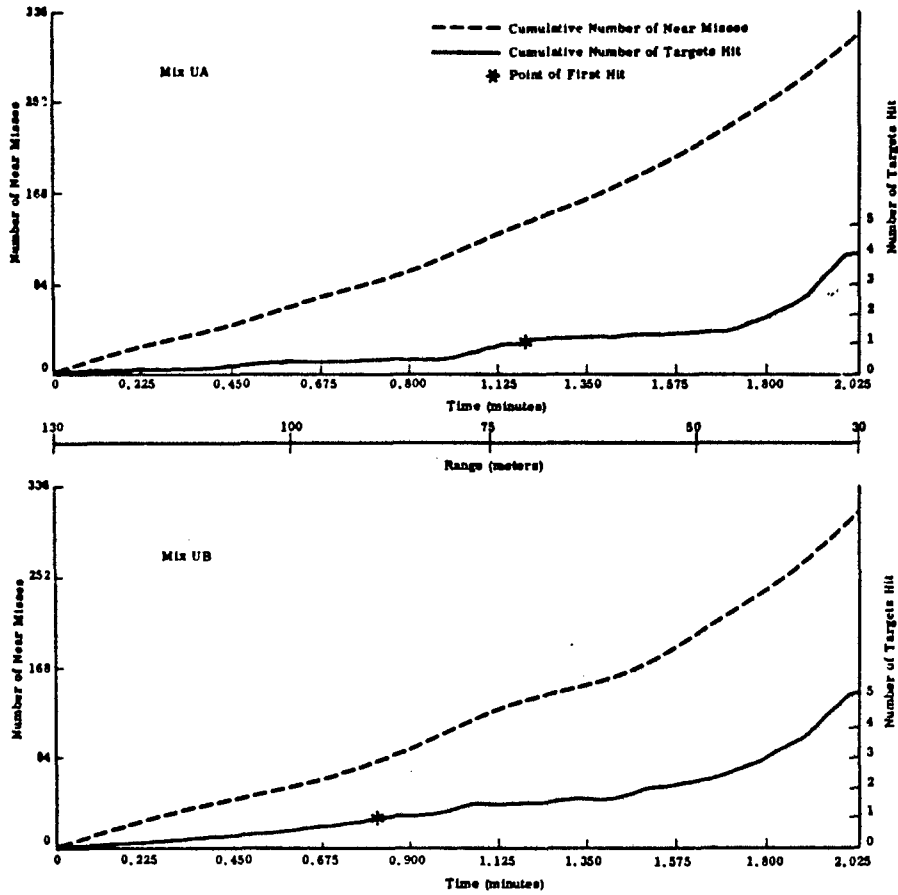

Figure 6-3 CUMULATIVE NUMBER OF NEAR MISSES AND TARGETS HIT--SITUATION 1

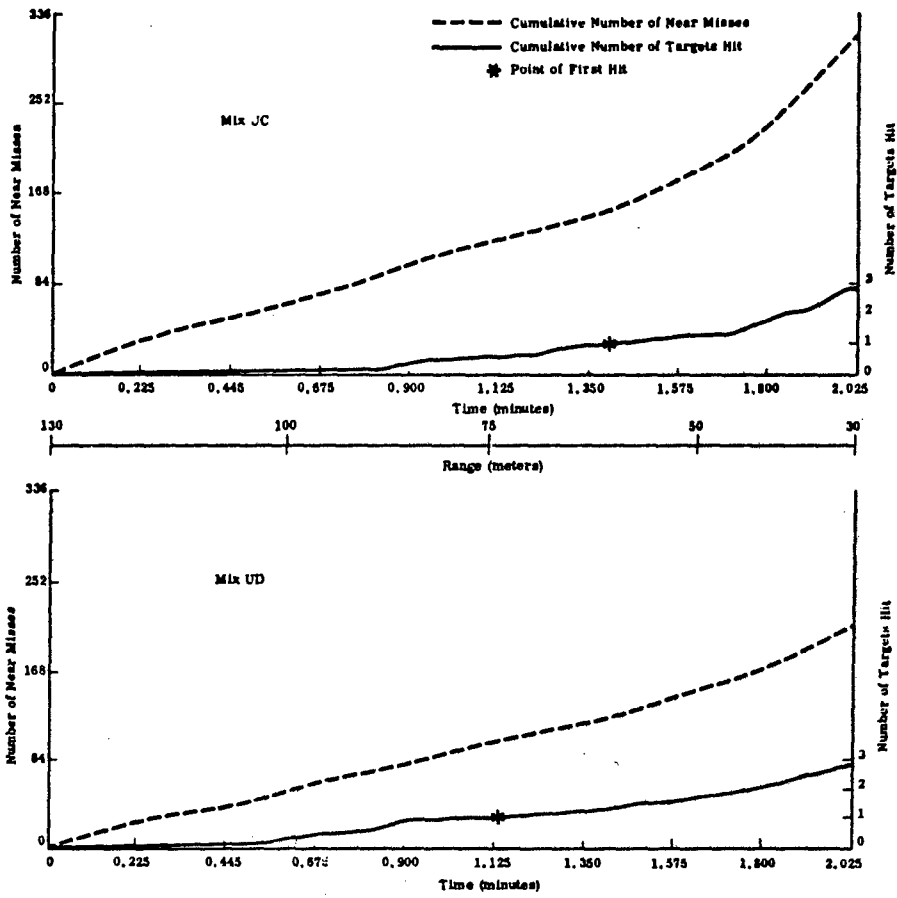

Figure 6-3 (Continued) CUMULATIVE NUMBER OF NEAR MISSES AND TARGETS HIT--SITUATION 1

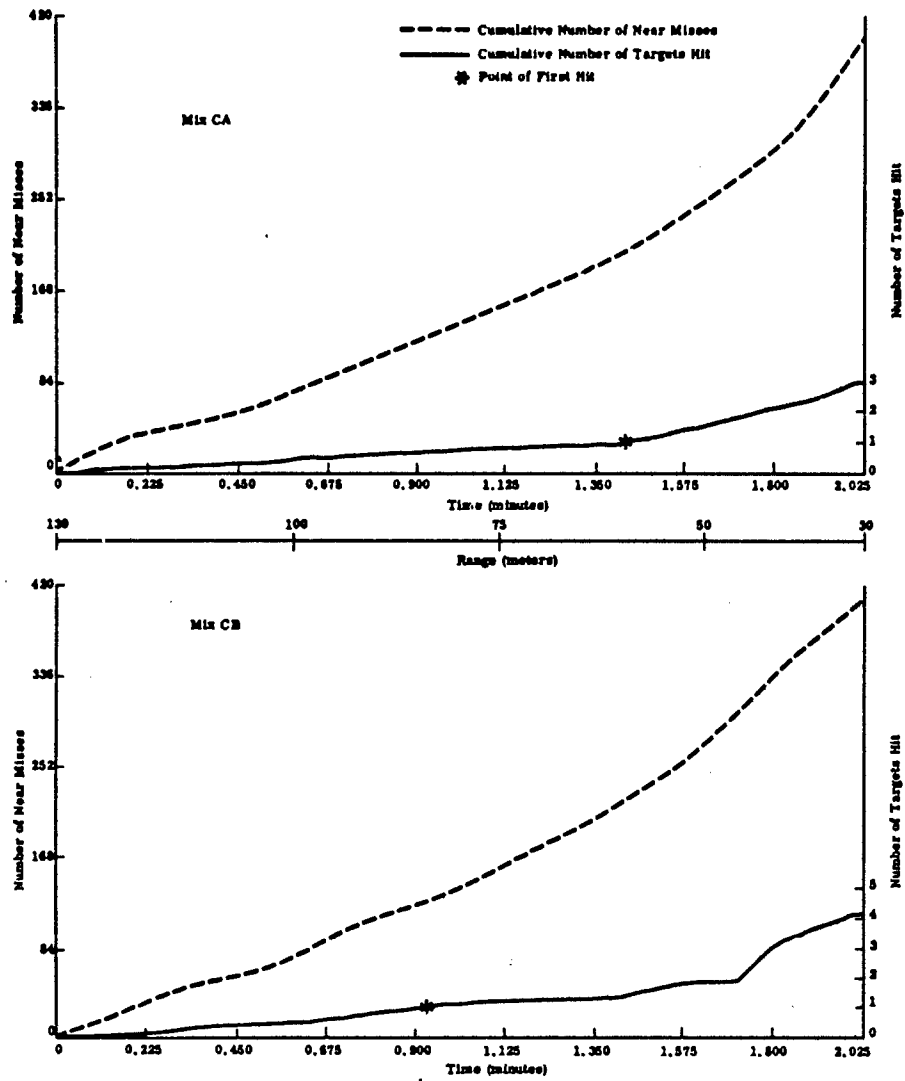

Figure 6-3 (Continued) CUMULATIVE NUMBER OF NEAR MISSES AND TARGETS HIT--SITUATION 1



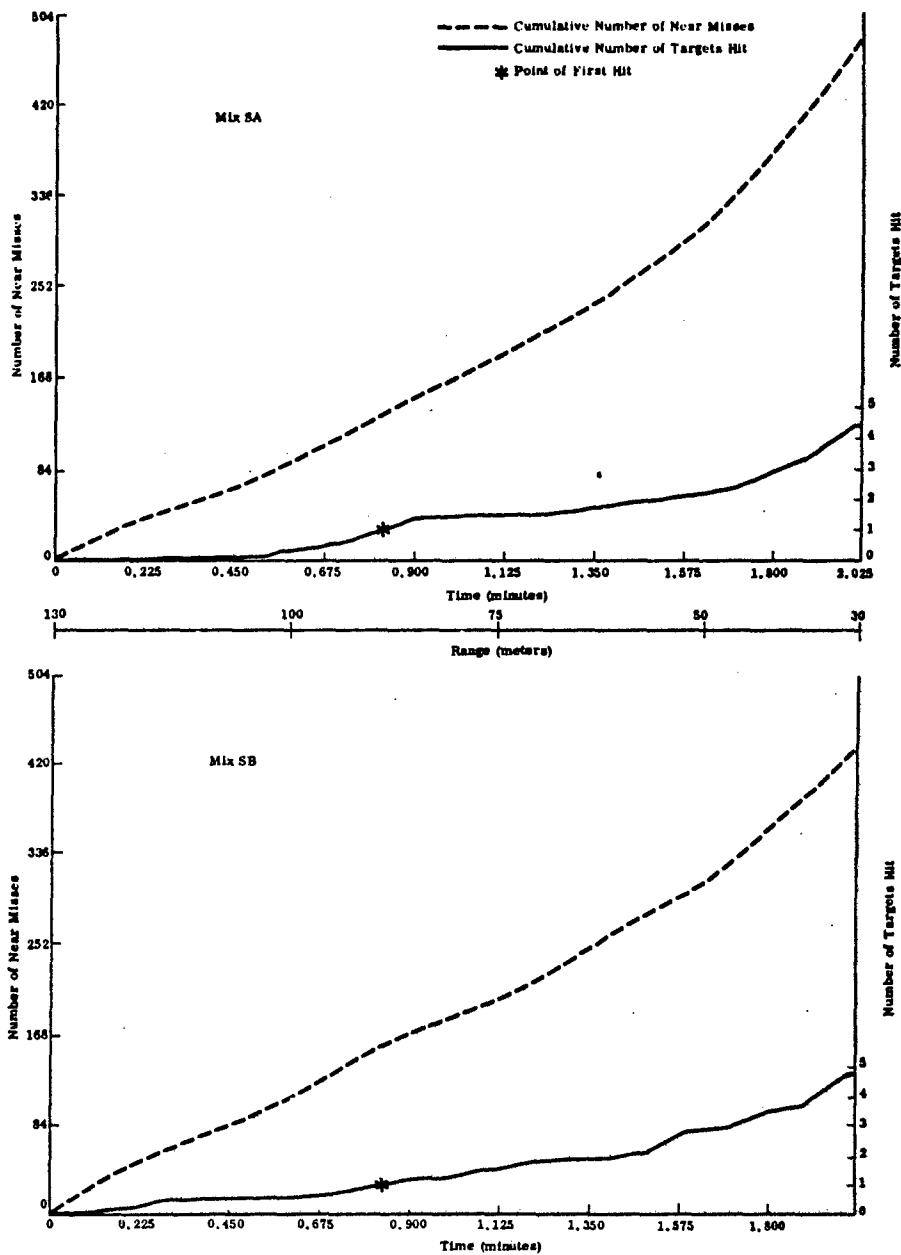

Figure 6-3 (Continued) CUMULATIVE NUMBER OF NEAR MISSES AND TARGETS HIT--SITUATION 1

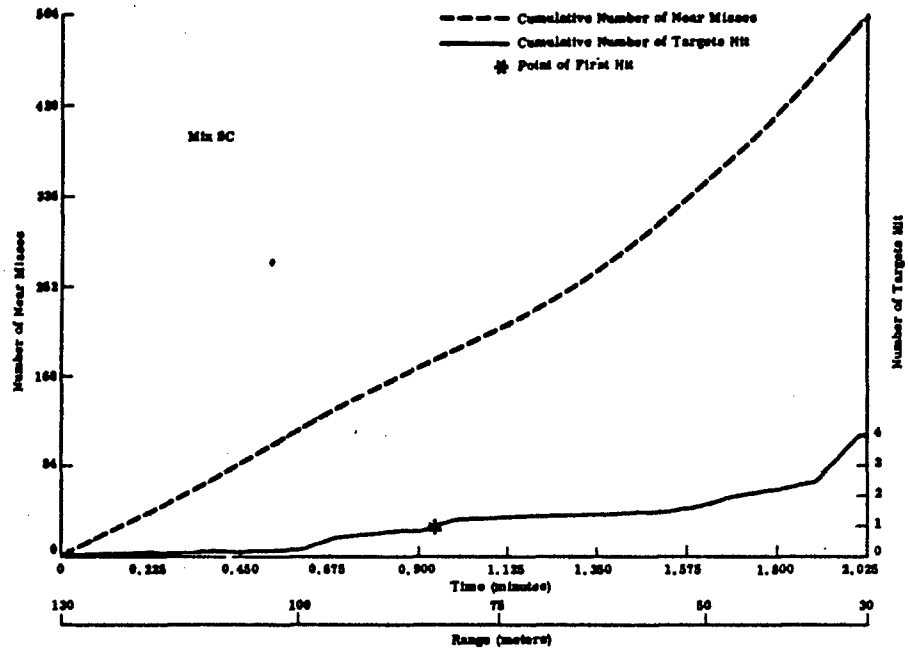

Figure 6-3 (Continued) CUMULATIVE NUMBER OF NEAR MISSES AND TARGETS HIT--SITUATION 1

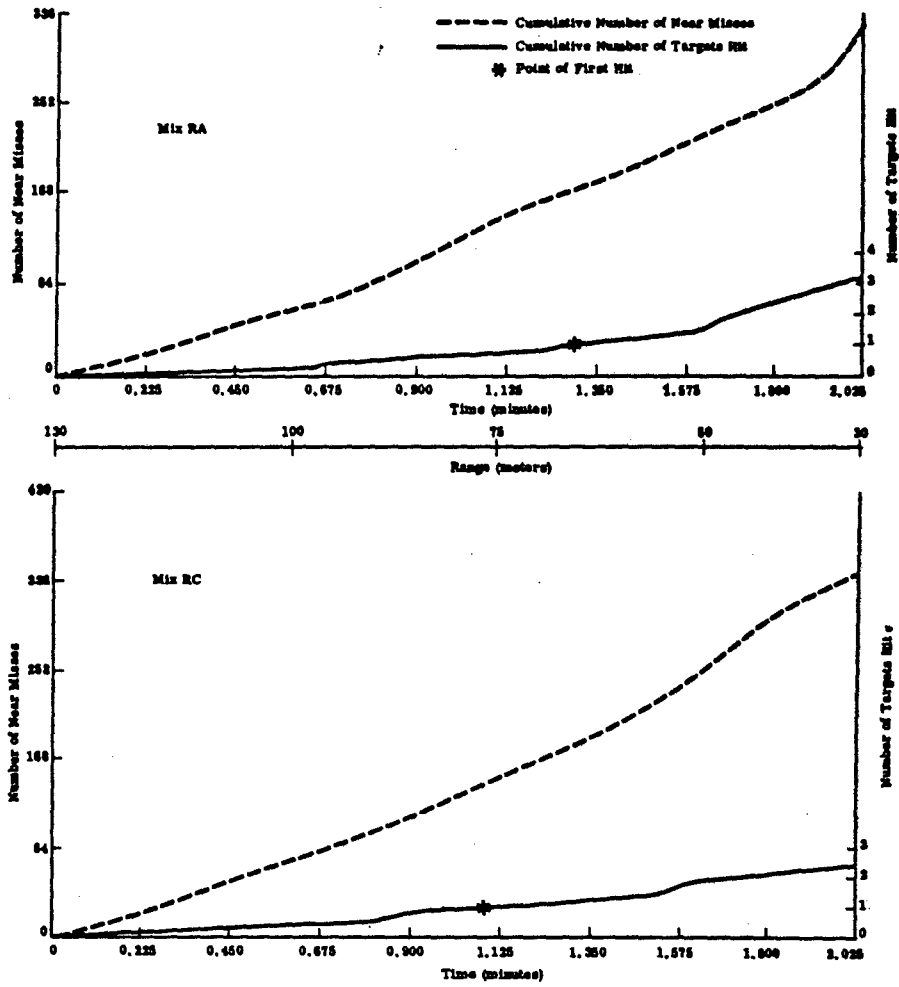

Figure 6-3 (Concluded) CUMULATIVE NUMBER OF NEAR MISSES AND TARGETS HIT--SITUATION 1

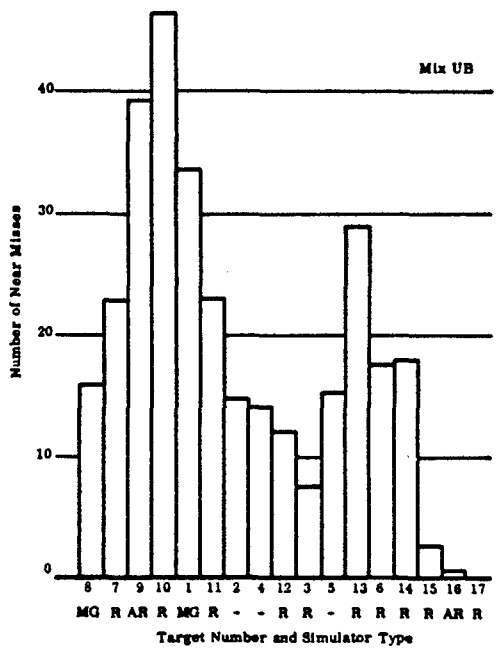
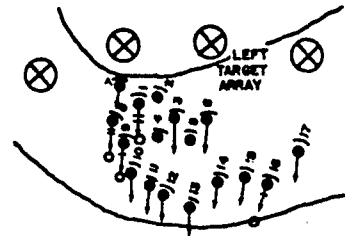
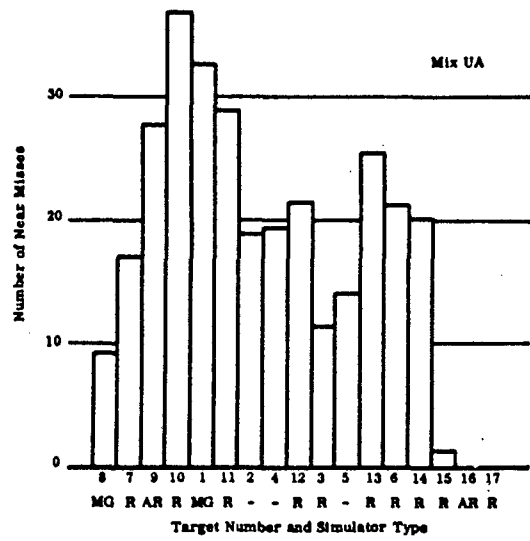

Figure 6-4 NUMBER AND DISTRIBUTION OF NEAR MISSES--SITUATION 1

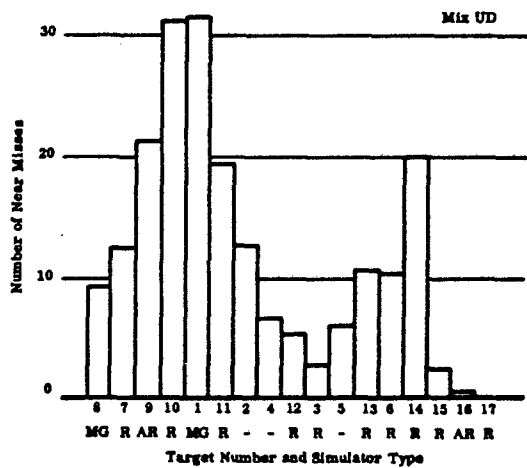
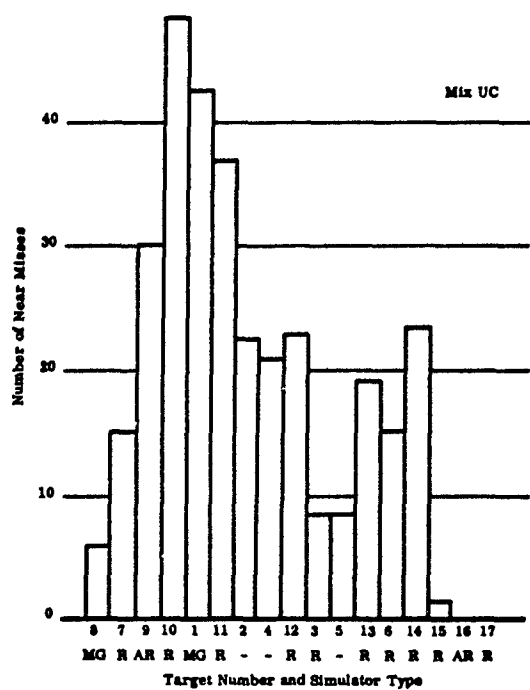

Figure 6-4 (Continued) NUMBER AND DISTRIBUTION OF NEAR MISSES--SITUATION 1

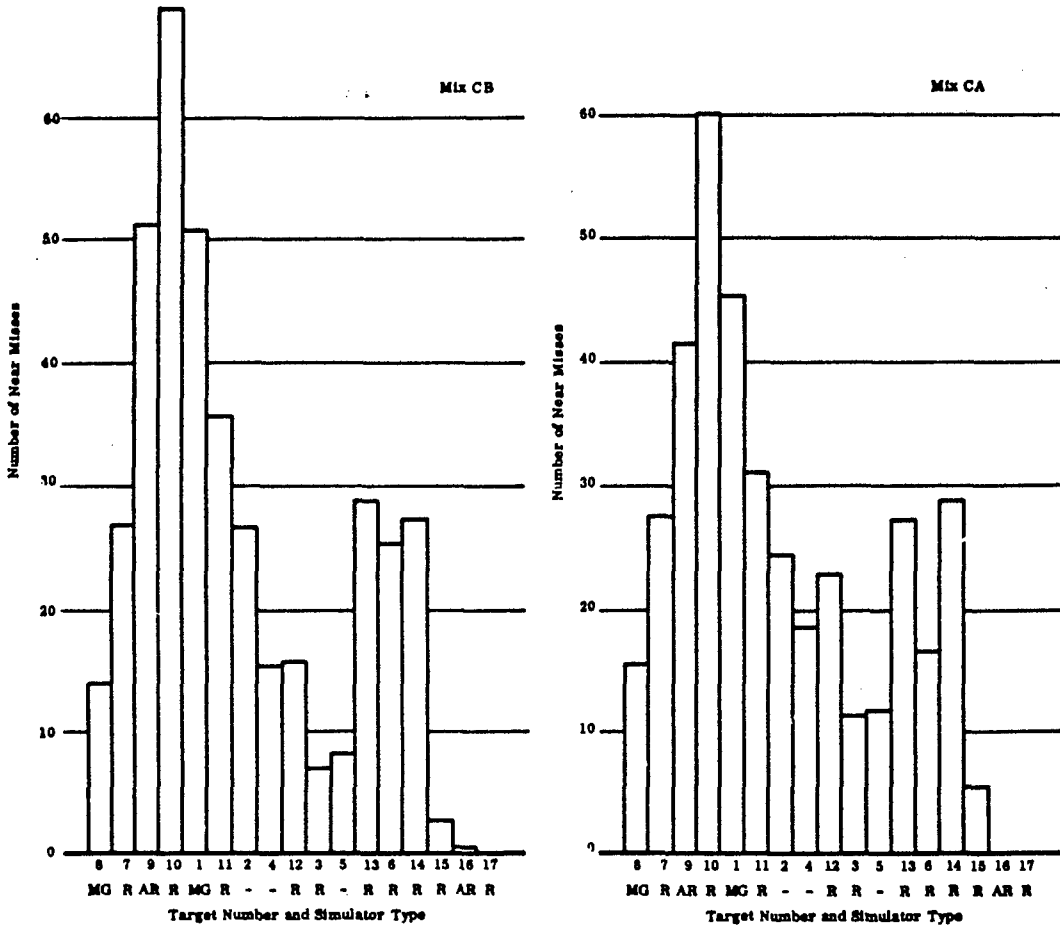
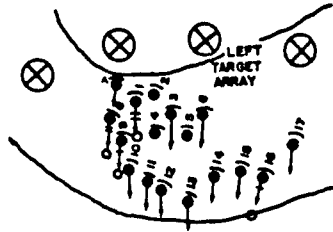

Figure 6-4 (Continued) NUMBER AND DISTRIBUTION OF NEAR MISSES--SITUATION 1

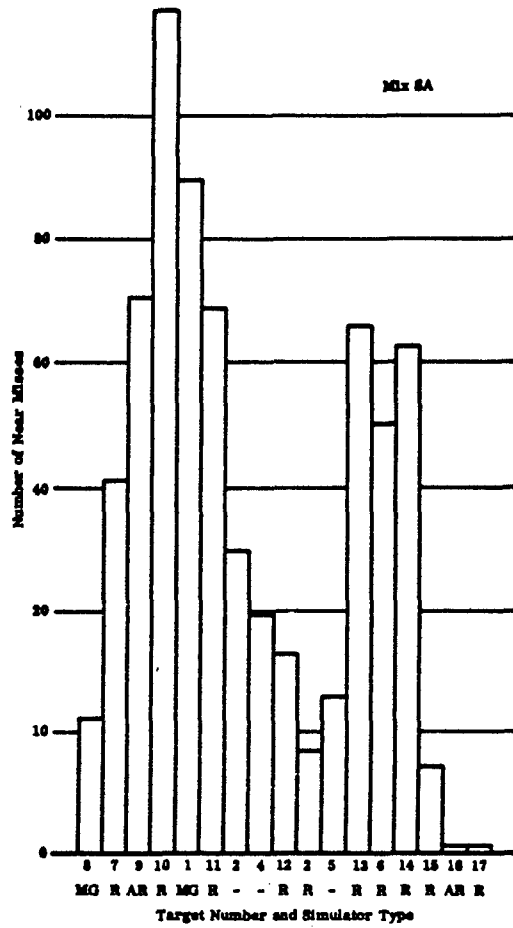

Figure 6-4 (Continued) NUMBER AND DISTRIBUTION OF NEAR MISSES--SITUATION 1

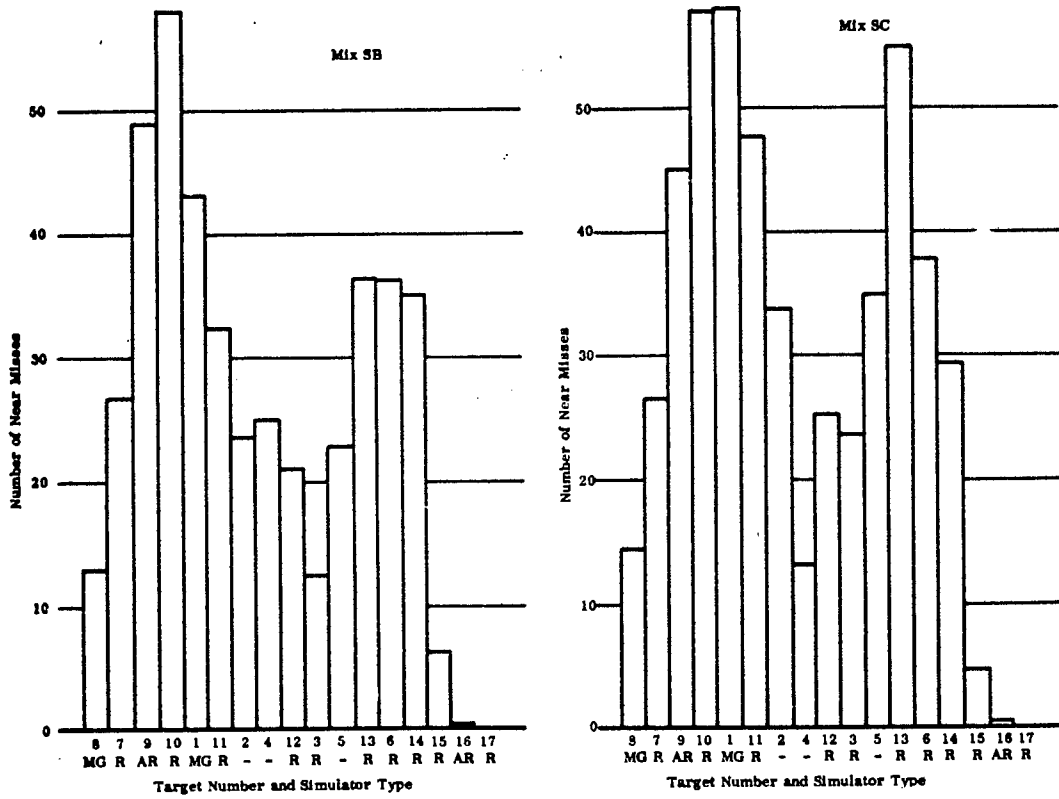
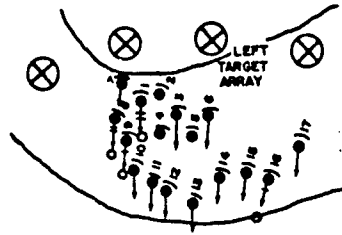

Figure 6-4 (Continued) NUMBER AND DISTRIBUTION OF NEAR MISSES--SITUATION 1.



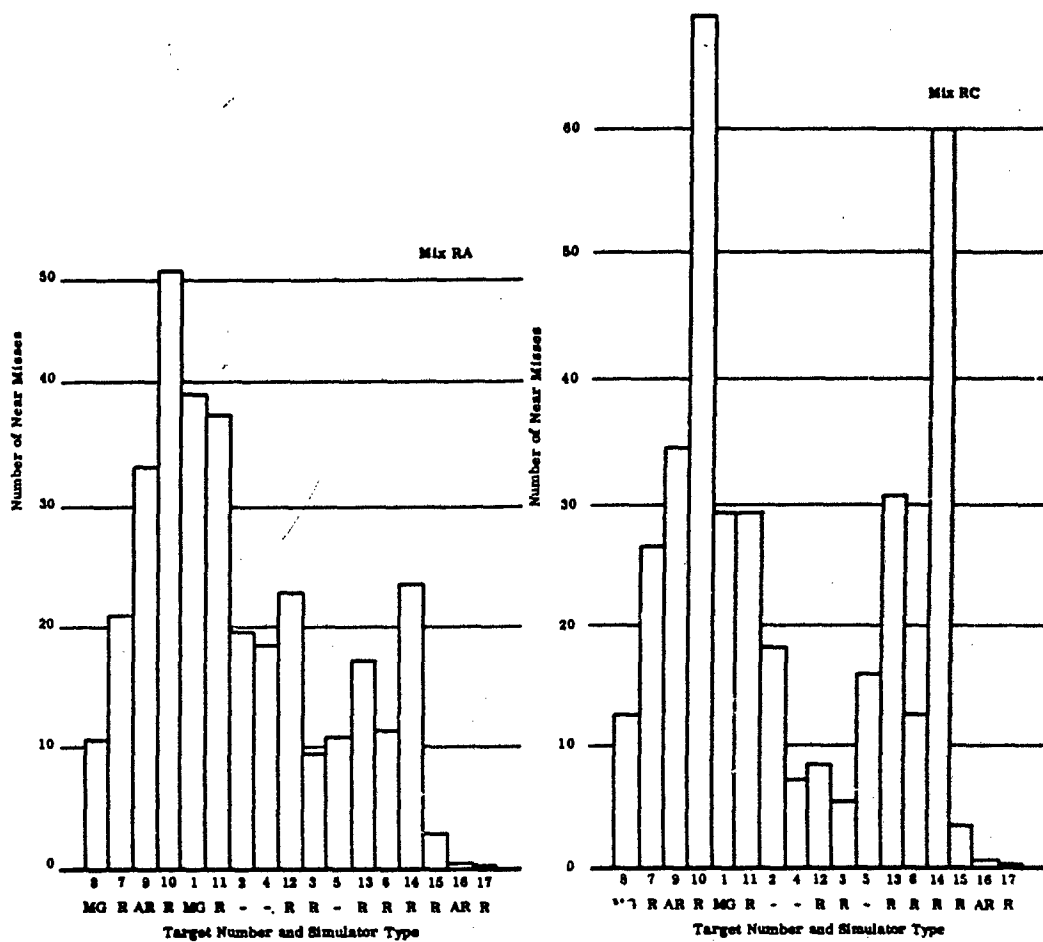

Figure 6-4 (Concluded) NUMBER AND DISTRIBUTION OF NEAR MISSES--SITUATION 1

**2. Situation 2: Rifle Squad as Base of Fire Supporting the Assault**

This situation evaluated rifle squad weapon mixes firing supporting fire from hastily prepared foxholes. Range from the foxholes to enemy targets was from 269 to 326 meters. There were 30 concealed or partially concealed enemy targets occupying a position 100 meters wide and 35 meters deep. The duration of fire was 4 minutes. For the first 2 minutes, fire was directed at the left 50 meters of the enemy array (the 17 targets used in Situation 1 Assault). Fire was then shifted 50 meters to the right, to an area containing 13 targets. The technique of fire provided area fire distributed throughout the sector with point fire employed when a target was seen, or when weapon simulators gave detected cues to a particular target location.

Results for Situation are tabulated and presented graphically in Figure 6-5.

Vertical profiles of the target arrays appear in Figure 6-6, showing positions and relative differences in elevation as seen from the support positions. The average number of near misses for all rifle mixes (not including special weapons mixes or duplex) is given by the number over each target. Also indicated are the simulator cues associated with each target and the total width of the 2-meter radius semicircular zone in which near misses were sensed.

Figure 6-7 illustrates the cumulative number of near misses for each array, the percent of ammunition remaining, targets hit, and ammunition used as a function of time. For Mix RC, only cumulative number of hits is presented. Figure 6-8 shows the number of near misses and their distributions as a function of target location and array. Target locations are provided for purpose of comparison in insert maps.

The rank order of the ten weapons mixes with associated standard scores is presented below.

Target Effects Only			Overall Effectiveness*		
Rank	Mix	Standard Score	Rank	Mix	Standard Score
1	CA	68.2	1	CA	73.6
2	SC	60.1	2	CB	62.6
3	UB	59.9	3	UA	55.4
4	UA	58.9	4	SC	54.8
5	CB	57.0	5	UB	51.2
6	UD	56.9	6	UD	48.2
7	SB	47.1	7	SA	46.5
8	UC	43.5	8	SB	45.5
9	SA	36.5	9	UC	36.4
10	RA	11.6	10	RA	29.8

\* Sustainability weighted 1/3; Target effects 2/3

Key:

- |                                    |   |
|------------------------------------|---|
| UA - 9 M14 Rifles                  | SB - 7 Stoner Rifles and<br>2 Stoner AR |
| UD - 9 M14E2 Rifles                | SC - 7 Stoner Rifles and<br>2 Stoner MG |
| UB - 7M14 Rifles and<br>2 M14E2 AR | CA - 9 Colt Rifles                      |
| UC - 5M14 Rifles and<br>2 M60 MG   | CB - 7 Colt Rifles and<br>2 Colt AR     |
| SA - 9 Stoner Rifles               | RA - 9 AK47 Rifles                      |

Mix RC results for Situation 2 are presented below.

Mix	CET	Percent Ammo Remaining	Near Misses	Targets Hit	Total Hits
RC	80.70	0	354.80	10.00	10.4

EFFECTIVENESS MEASURES

COLLATERAL PERFORMANCE

A Cumulative Exposure Times					B Number of Near Misses					C Sustainability (T. Ammo Remaining)					D Number of Targets Hit					E Tot	
Mix	X	CET	SD	Standard Score z'	Mix	X	Near Misses	SD	Standard Score z'	Mix	X	Remaining	SD	Standard Score z'	Sustainability Time (Min)	Mix	X	Targets Hit	SD	Standard Score z'	Mix
UA	77.5	2.3	77.1		CB	345	47.9	73.6		CA	50.5	9.2	84.4	8.1		UA	10.7	1.7	82.2	UA	
CA	78.2	10.0	71.2		SC	326	76.3	66.4		CB	42.2	1.6	73.9	6.9		CA	10.1	3.5	69.8	UB	
UD	78.6	8.3	68.3		CA	323	90.7	65.2		RA	36.0	6.1	66.1	6.3		UB	10.0	1.6	67.8	CA	
UB	80.0	6.6	59.0		UC	318	34.4	63.4		SA	28.5	4.3	56.7	5.6		SB	9.4	2.9	55.4	SB	
BC	80.4	9.4	53.8		UB	312	46.7	60.8		UA	22.0	6.7	48.5	5.1		SC	9.1	3.2	49.2	SA	
BB	81.0	10.1	48.9		UD	272	52.3	45.6		SB	17.2	6.8	42.5	4.8		BA	8.9	2.4	44.5	UD	
BA	82.0	9.1	41.4		SB	271	72.1	45.2		SC	16.2	8.5	41.2	4.8		UD	8.8	3.2	43.0	SC	
CB	82.1	4.6	40.4		UA	259	36.1	40.6		UD	10.3	5.6	33.8	4.5		CB	8.6	2.4	38.8	CB	
UC	84.2	7.2	23.6		SA	236	61.3	31.8		UC	7.8	6.7	30.6	4.3		UC	8.5	2.9	36.8	UC	
RA	85.1	10.9	16.6		RA	173	22.0	6.6		UC	1.2	1.5	22.3	4.1		RA	7.3	3.9	12.0	RA	
X	80.9				X	283.7				X	23.8					X	9.14			X	
SD	2.52				SD	52.18				SD	15.9					SD	.97			SD	

F Target Effects		G Overall Effectiveness		H Cumulative Exposure Times										I Number of Near Misses					
Mix	Standard Score Target Effects	Mix	Overall Fire Effectiveness	UA	CA	UD	UB	SC	SB	SA	CB	UC	RA	CB	SC	CA	UC	UB	UD
CA	68.2	CA	73.6																
SC	60.1	CB	62.6	>.40	.38	.22	.24	.21	.14	.03	.03	.07		.35	.33	.25	.22	.06	
UB	59.9	UA	55.4		>.40	.38	.35	.32	.26	.20	.13	.15			>.40	>.40	.35	.09	
UA	58.9	SC	54.8			>.40	.37	.33	.26	.19	.12	.15				>.40	.39	.11	
CB	57.0	UB	51.2				>.40	>.40	.32	.24	.15	.17							
UD	56.9	UD	48.2					>.40	.39	.35	.23	.23						.10	
SB	47.1	SA	46.5						>.40	>.40	.27	.27							
UC	43.5	SB	45.5							>.40	.32	.31							
SA	36.5	UC	36.4								.28	.28							
RA	11.6	RA	29.8										>.40						

J Sustainability (i Ammo Remaining)										K No. of Targets Hit										L Total Hits on Tar								
CA	CB	RA	SA	UA	SB	SC	UB	UD	UC	UA	CA	UB	SB	SC	SA	UD	CB	UC	RA	UA	UB	CA	SB	SA	UD			
CA		.03	.01	.001	.001	.001	.001	.001	.001	UA		.35	.23	.18	.15	.08	.11	.05	.07	.04	UA		.11	.15	.11	.07	.10	
CB			.02	.001	.001	.001	.001	.001	.001	CA			>.40	.36	.31	.25	.26	.20	.21	.12	UB			>.40	.39	.24	.31	
RA				.02	.004	.001	.002	.001	.001	UB				.34	.28	.20	.23	.14	.15	.08	CA				>.40	.34	.36	
SA					.04	.004	.005	.001	.001	SD					>.40	.37	.37	.30	.30	.16	SB					>.40	>.40	
UA						.12	.11	.005	.003	SC					>.40	>.40	.39	.37	.21	SA							>.40	
SB							>.40	.04	.02	SA						>.40	>.40	>.40	.21	UD								
SC								.10	.05	UD							>.40	>.40	.24	SC								
UB									.25	CB								>.40	.25	UC								
UD										UC										.28	CB							

Note: Standard Scores computed from raw scores using scores to three decimal places.

UA - 9 M14 Rifles  
 UB - 7 M14 Rifles/2 M14E2 AR  
 UC - 5 M14 Rifles/2 M60 MG  
 UD - 9 M14E2 Rifles  
 CA - 9 Colt Rifles

CB - 7 Colt Rifles/2 Colt AR  
 SA - 9 Stoner Rifles  
 SB - 7 Stoner Rifles/2 Stoner AR  
 SC - 7 Stoner Rifles/2 Stoner MG  
 RA - 9 AK47 Rifles

X - Mean (Average)  
 SD - Standard Dev  
 CET - Cumulative E  
 z' - Standard Score

COLLATERAL PERFORMANCE MEASURES

D Number of Targets Hit				E Total Hits on Targets			
Mix	$\bar{X}$ Targets Hit	SD	Standard Score $z'$	Mix	$\bar{Y}$ Hits	SD	Standard Score $z'$
UA	10.7	1.7	82.2	UA	12.6	4.0	93.9
CA	10.1	3.5	69.8	UB	10.3	1.4	59.9
UB	10.0	1.6	67.8	CA	10.2	3.3	58.4
SB	9.4	2.9	55.4	SB	9.9	3.0	54.0
SC	9.1	3.2	49.2	SA	9.6	2.0	49.6
SA	8.9	2.4	44.5	UD	9.5	3.6	48.1
UD	8.8	3.2	43.0	SC	9.1	3.2	42.2
CB	8.6	2.4	38.8	UC	9.0	3.5	40.7
UC	8.5	2.9	36.8	CB	8.8	2.3	37.7
RA	7.3	3.9	12.0	RA	7.3	3.9	15.6
$\bar{X}$	9.14			$\bar{X}$	9.63		
SD	.97			SD	1.35		

Number of Near Misses

	CB	SC	CA	UC	UB	UD	SB	UA	SA	RA
17 CB		.35	.33	.25	.22	.06	.07	.02	.02	.002
15 SC			>.40	>.40	.35	.09	.12	.04	.02	.002
15 CA				>.40	.39	.11	.14	.05	.03	.003
17 UC					.39	.06	.09	.01	.01	.001
23 UB						.10	.14	.03	.02	.001
27 UD							>.40	.31	.15	.003
31 SB								.36	.19	.01
28 UA									.23	.001
10 SA										.03

Total Hits on Targets

	UA	UB	CA	SB	SA	UD	SC	UC	CB	RA
14 UA		.11	.15	.11	.07	.10	.07	.07	.04	.03
2 UB			>.40	.39	.24	.31	.21	.20	.10	.05
18 CA				>.40	.34	.36	.28	.27	.20	.10
6 SB					>.40	>.40	.33	.32	.24	.12
21 SA						>.40	.38	.37	.27	.12
11 UD							>.40	>.40	.35	.18
24 SC								>.40	>.40	.21
25 UC									>.40	.23
28 CB										.22

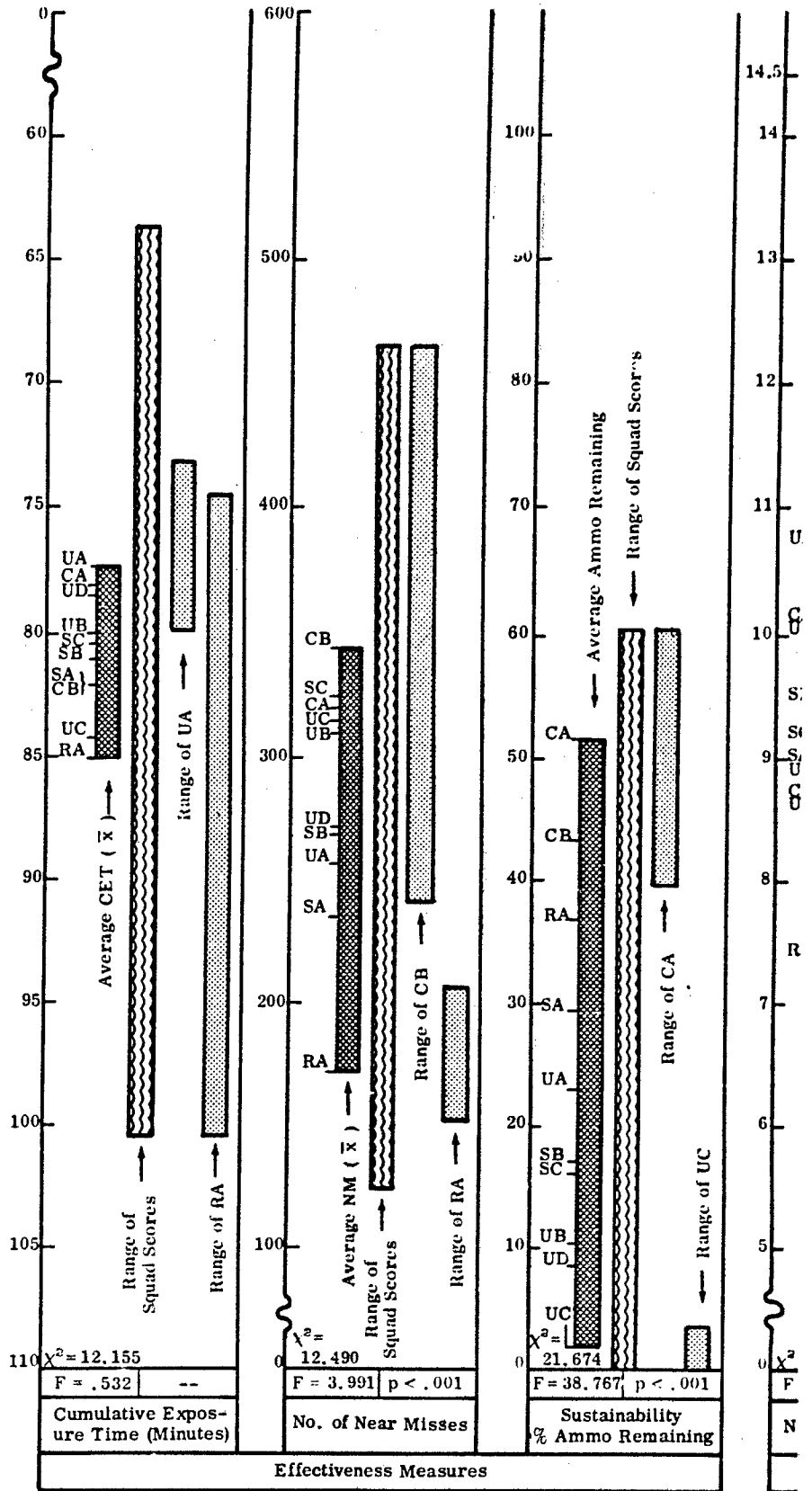

Colt AR  $\bar{X}$  - Mean (Average)  
 2 Stoner AR SD - Standard Deviation  
 2 Stoner MG CET - Cumulative Exposure Time  
 $z'$  - Standard Score ( $X = 50$ ,  $SD = 20$ )

Figure 6-5 SUMMARY OF RESULTS--S

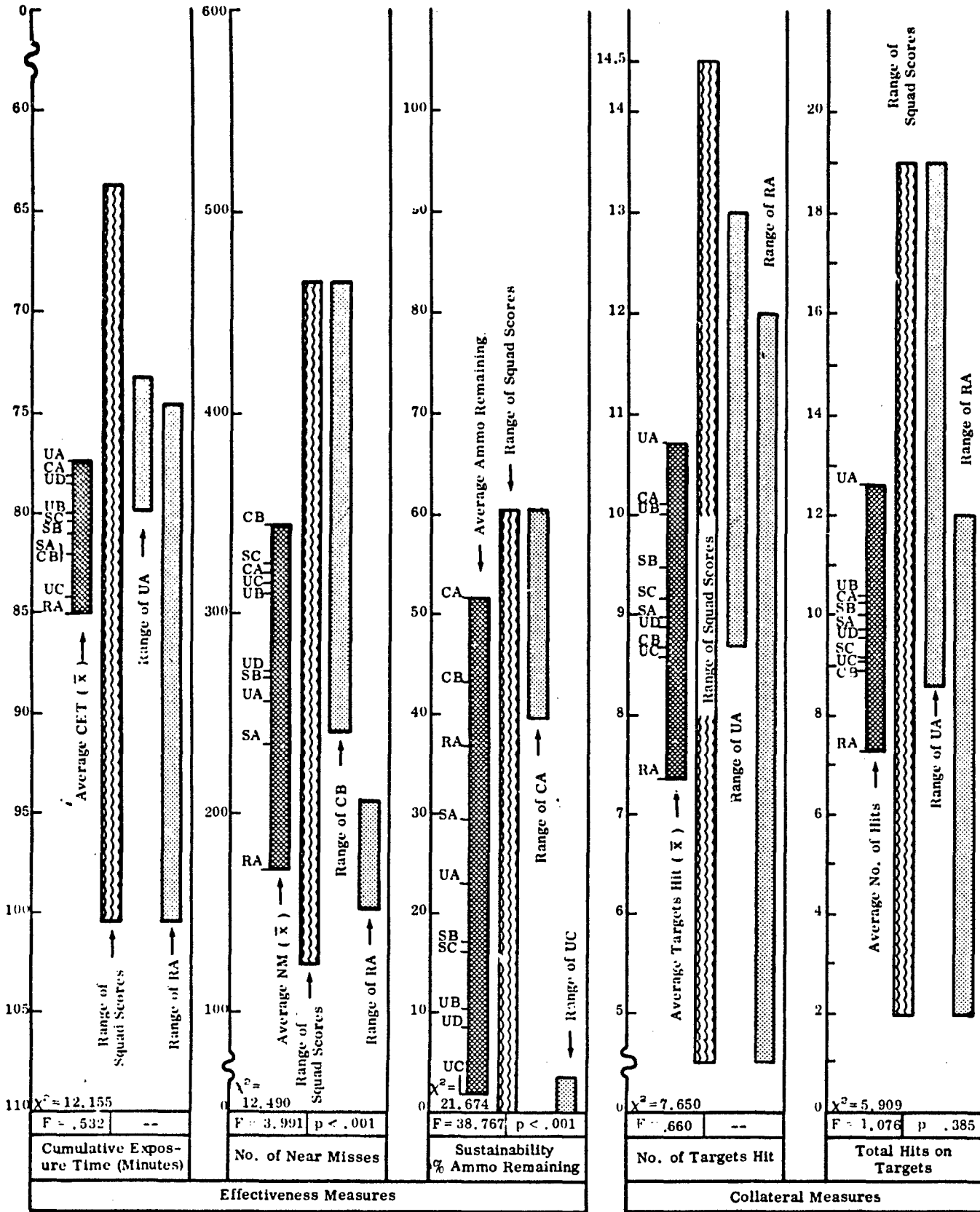
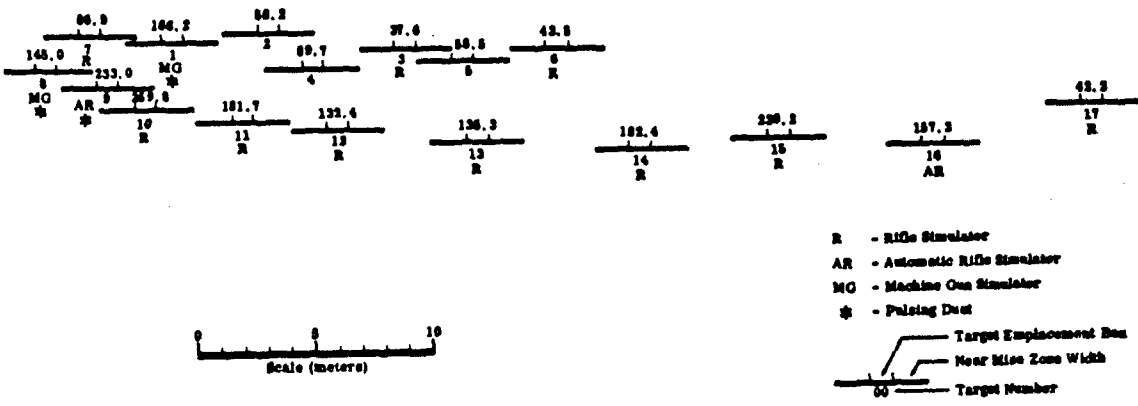
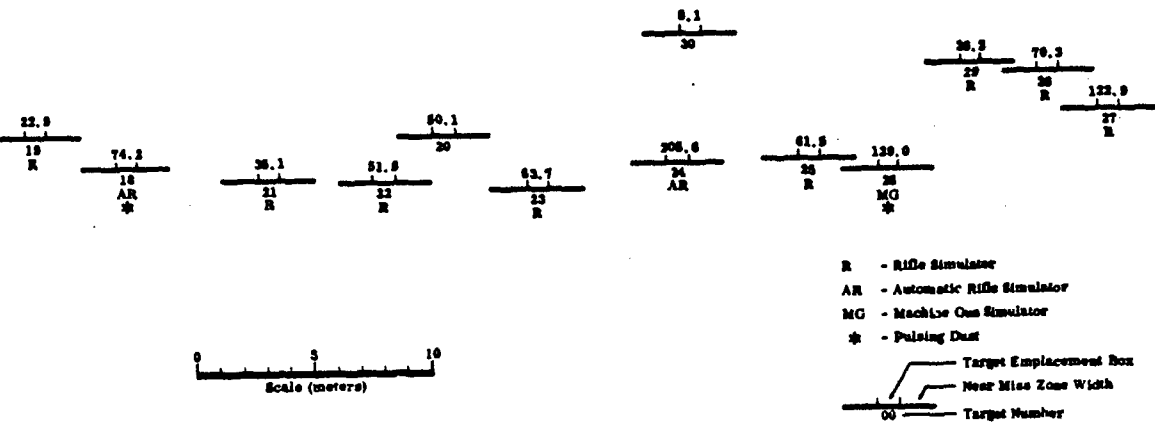

Figure 6-5 SUMMARY OF RESULTS--SITUATION 2



Left Array



Right Array

Figure 6-6 VERTICAL PROFILES--SITUATION 2

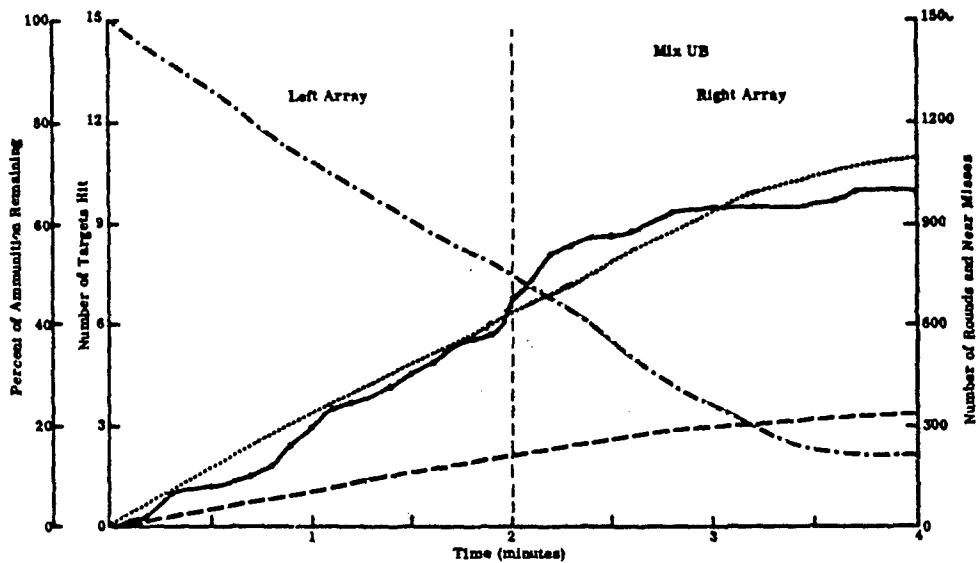
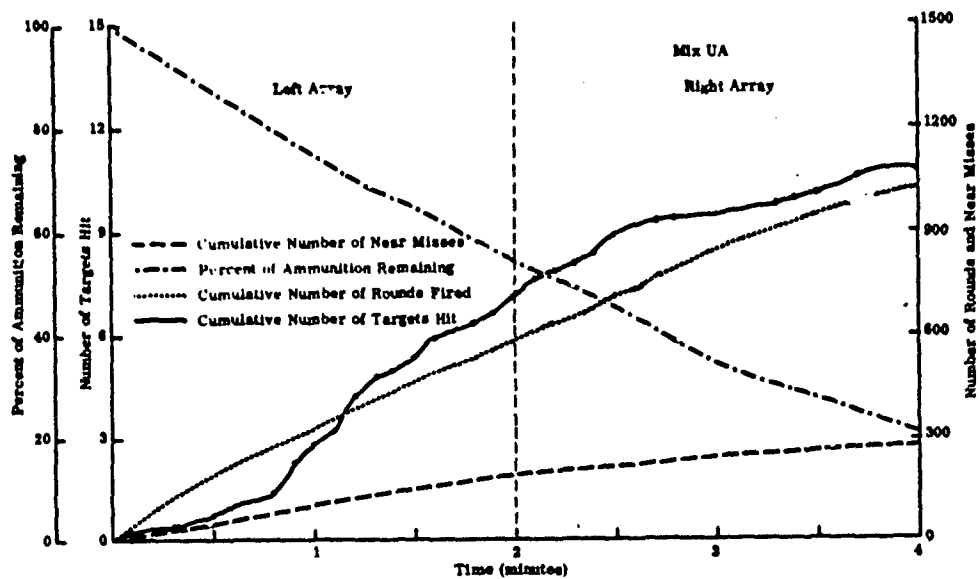

Figure 6-7 CUMULATIVE NUMBER OF ROUNDS FIRED, TARGETS HIT, NEAR MISSES, AND PERCENT OF AMMUNITION REMAINING--SITUATION 2



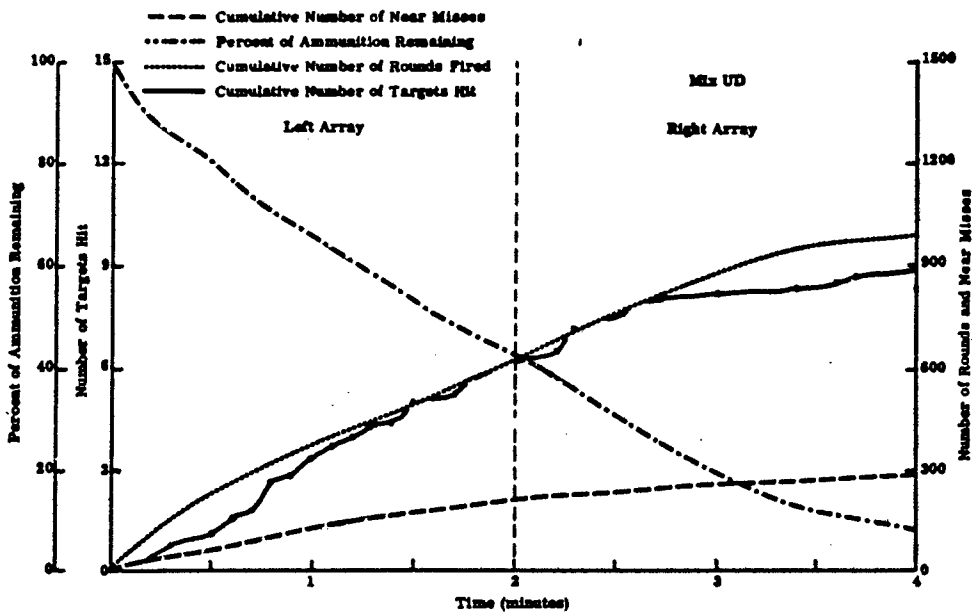
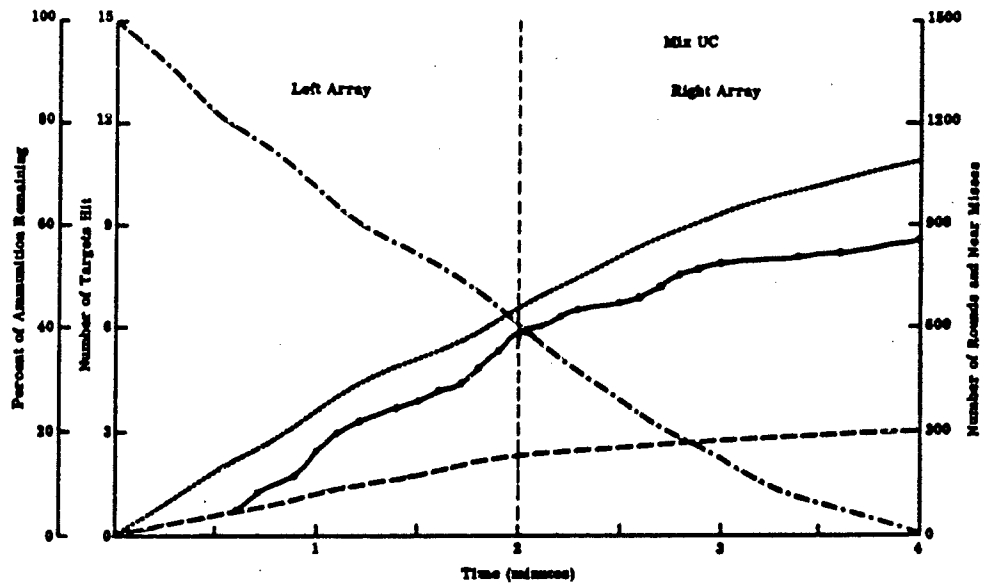

Figure 6-7 (Continued) CUMULATIVE NUMBER OF ROUNDS FIRED, TARGETS HIT, NEAR MISSES, AND PERCENT OF AMMUNITION REMAINING--SITUATION 2

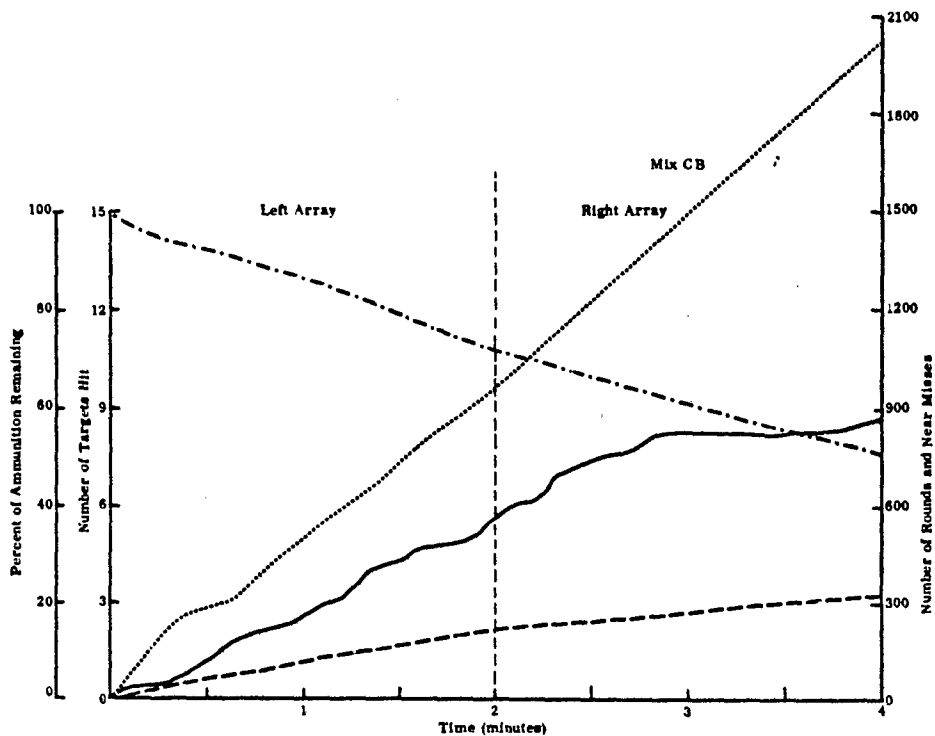
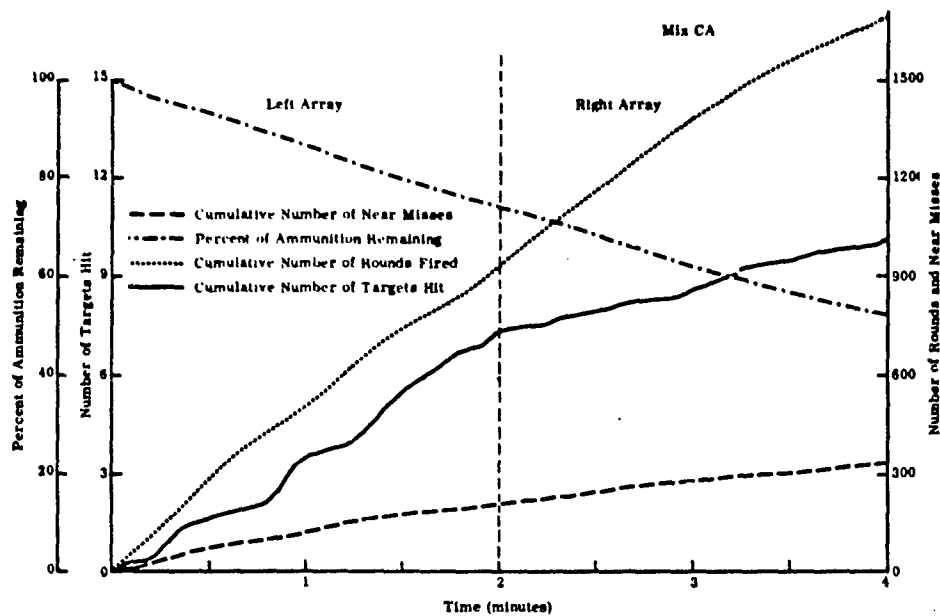

Figure 6-7 (Continued) CUMULATIVE NUMBER OF ROUNDS FIRED, TARGETS HIT, NEAR MISSES AND PERCENT OF AMMUNITION REMAINING--SITUATION 2

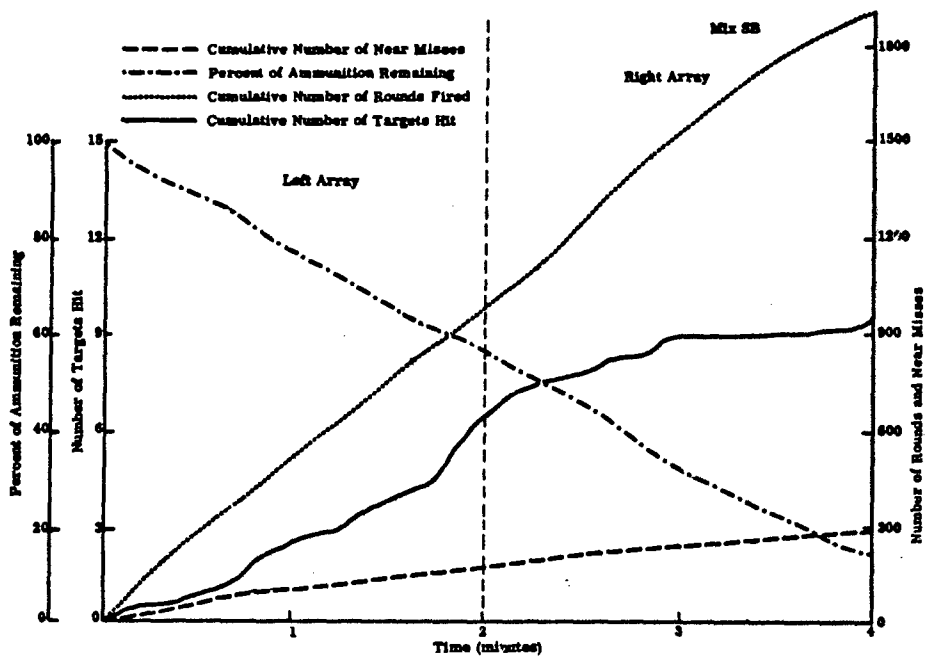
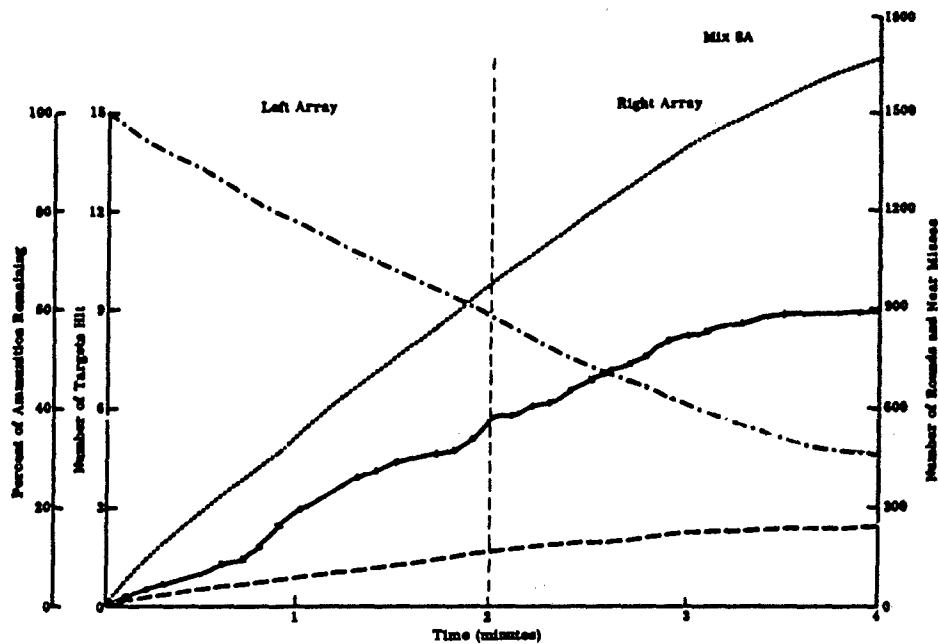

Figure 6-7 (Continued) CUMULATIVE NUMBER OF ROUNDS FIRED, TARGETS HIT, NEAR MISSES, AND PERCENT OF AMMUNITION REMAINING--SITUATION 2

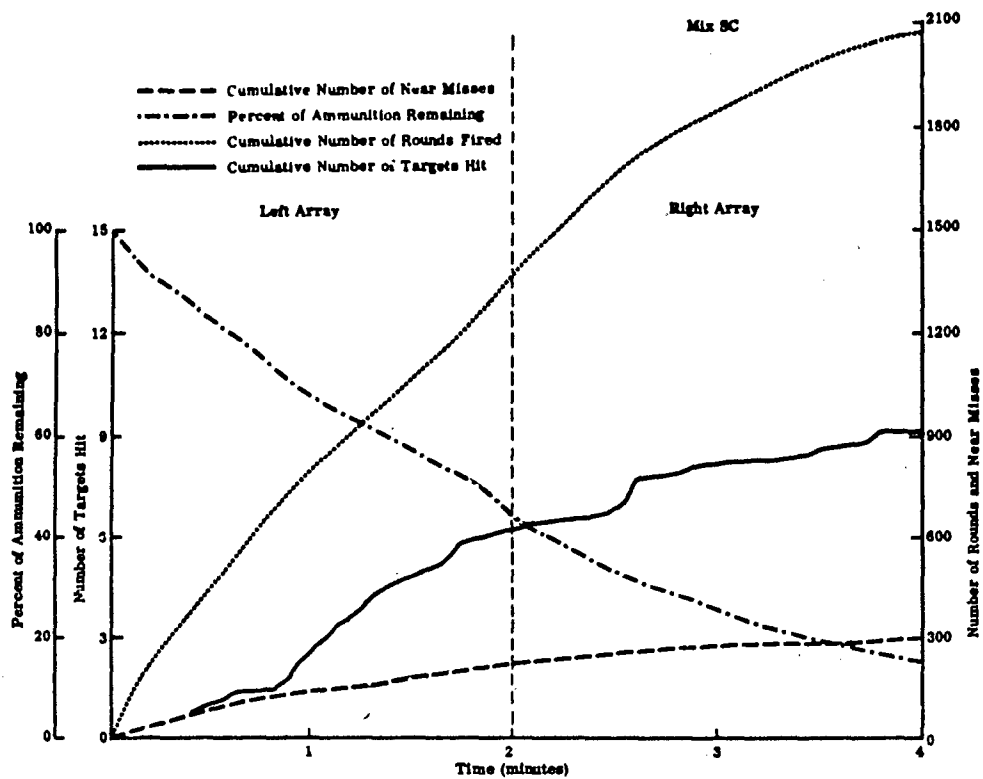

Figure 6-7 (Continued) CUMULATIVE NUMBER OF ROUNDS FIRED, TARGETS HIT, NEAR MISSES, AND PERCENT OF AMMUNITION REMAINING--SITUATION 2

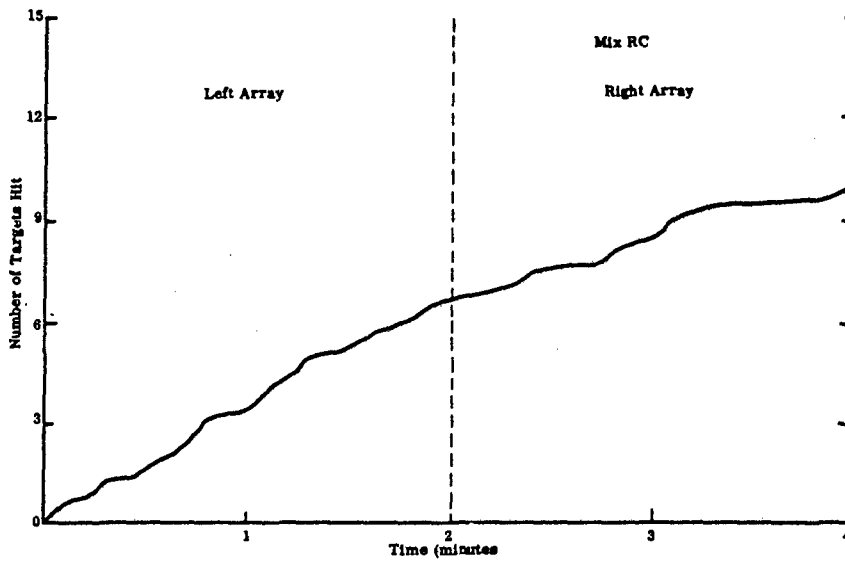
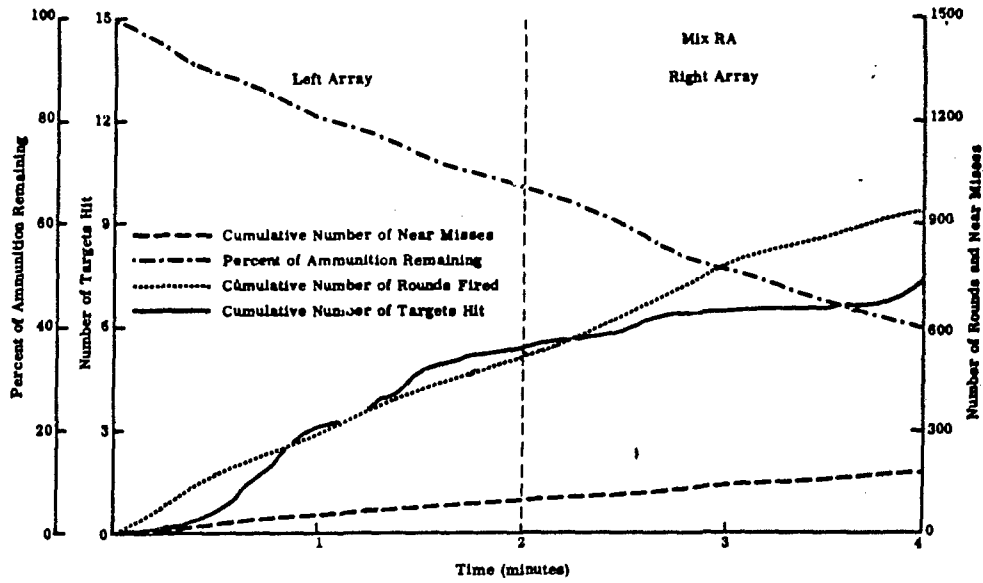

Figure 6-7 (Concluded) CUMULATIVE NUMBER OF ROUNDS FIRED, TARGETS HIT, NEAR MISSES, AND PERCENT OF AMMUNITION REMAINING--SITUATION 2

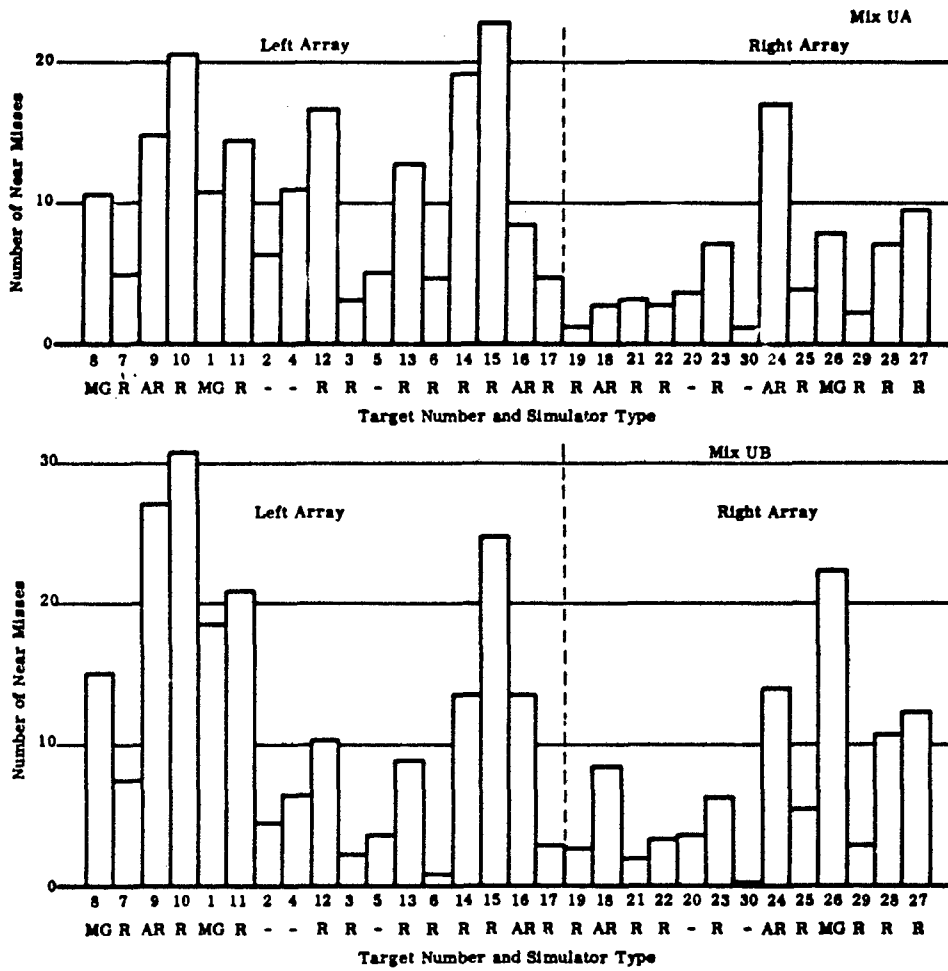
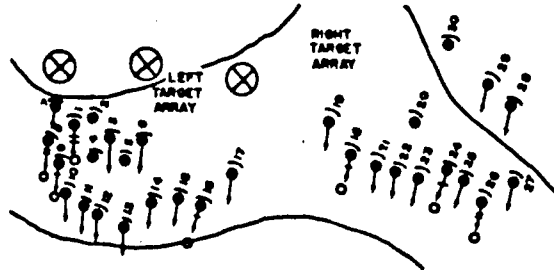

Figure 6-8  
NUMBER AND DISTRIBUTION OF NEAR MISSES--SITUATION 2

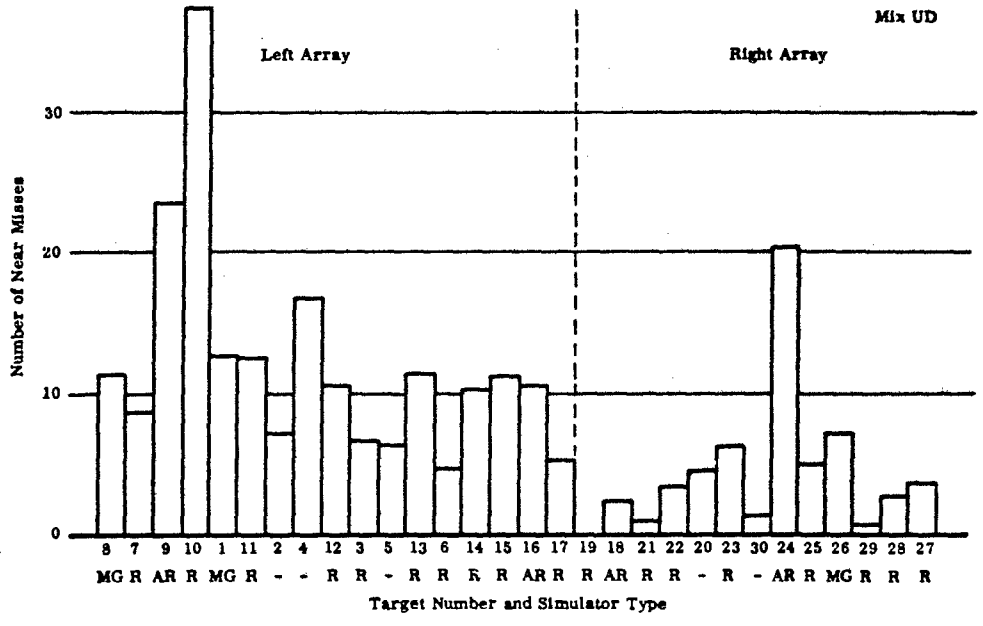
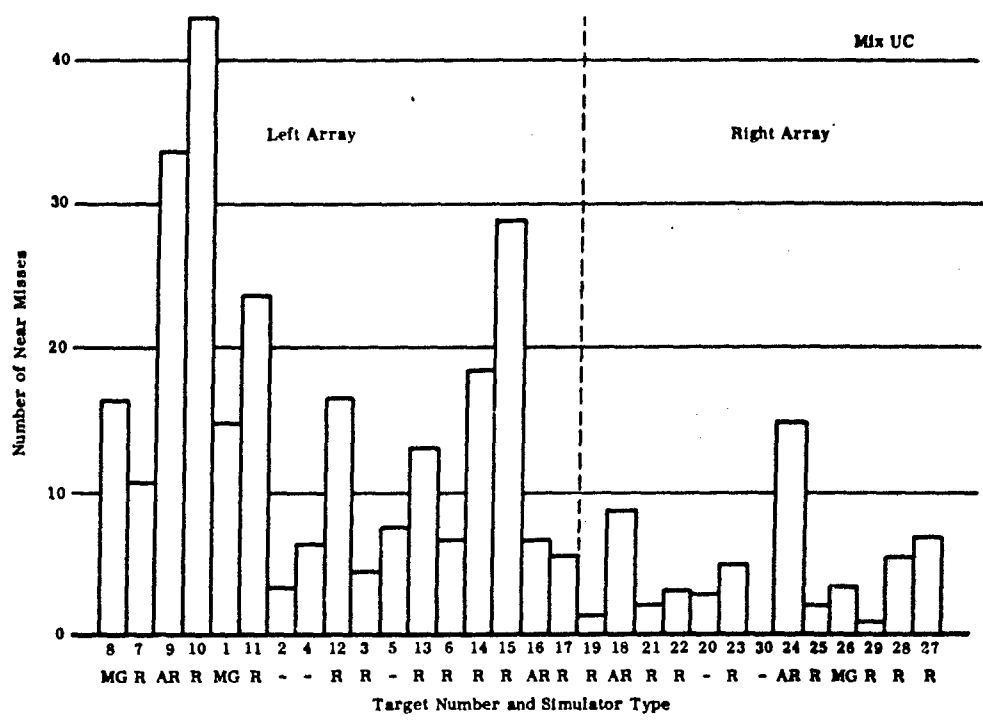

Figure 6-8 (Continued)  
 NUMBER AND DISTRIBUTION OF NEAR MISSES--SITUATION 2

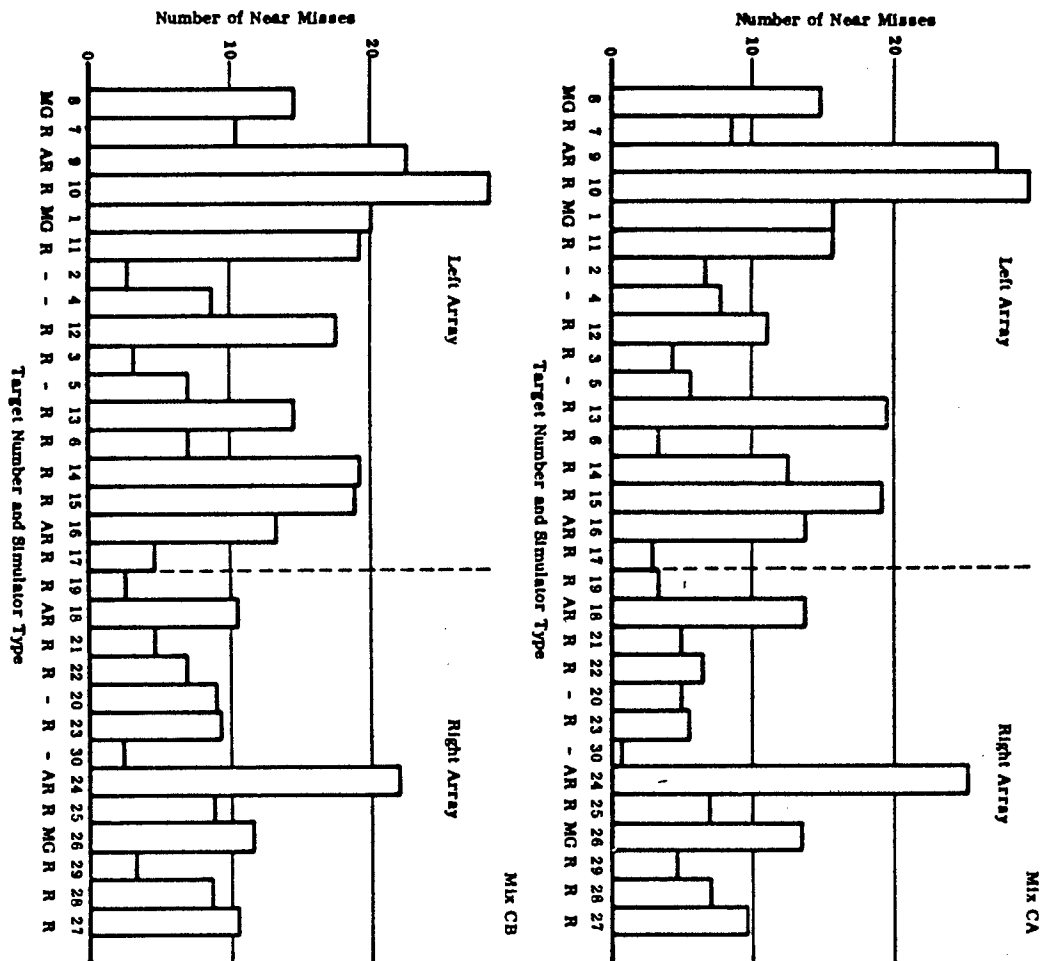
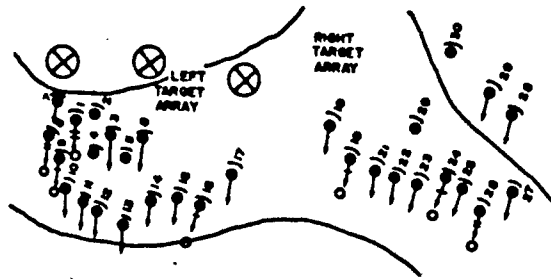

Figure 6-8 (Continued)  
 NUMBER AND DISTRIBUTION OF NEAR MISSES--SITUATION 2



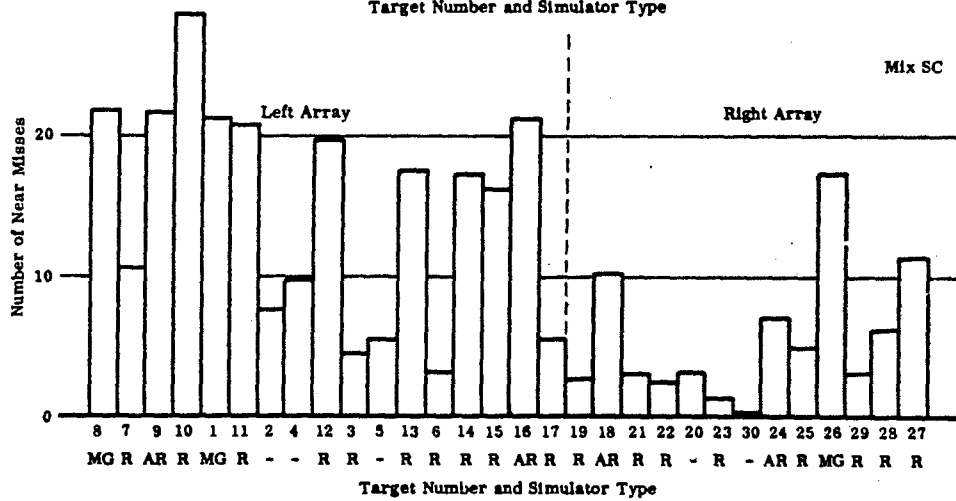
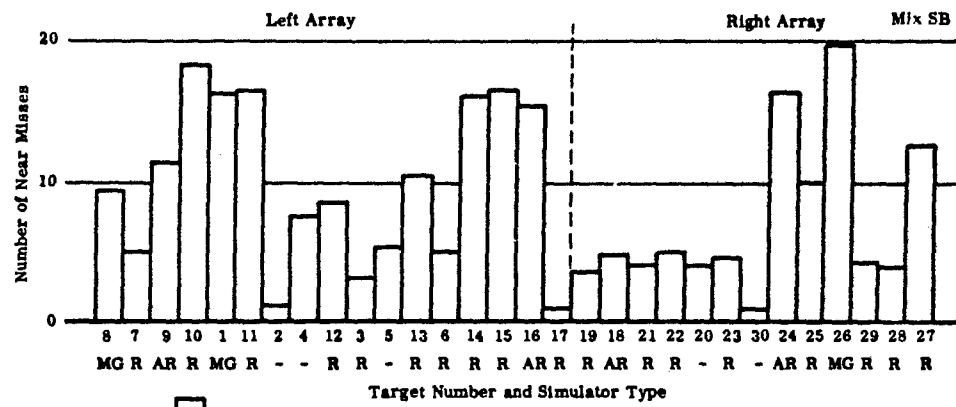
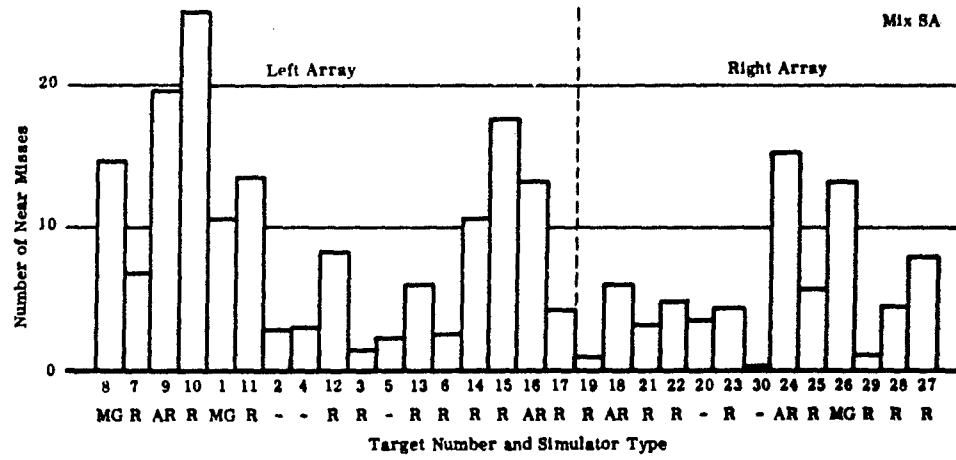

Figure 6-8 (Continued)

NUMBER AND DISTRIBUTION OF NEAR MISSES--SITUATION 2

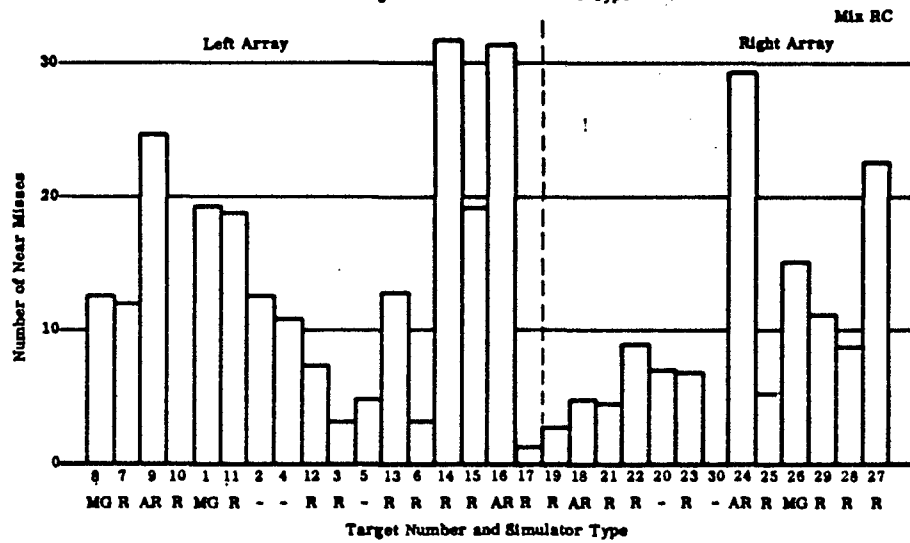
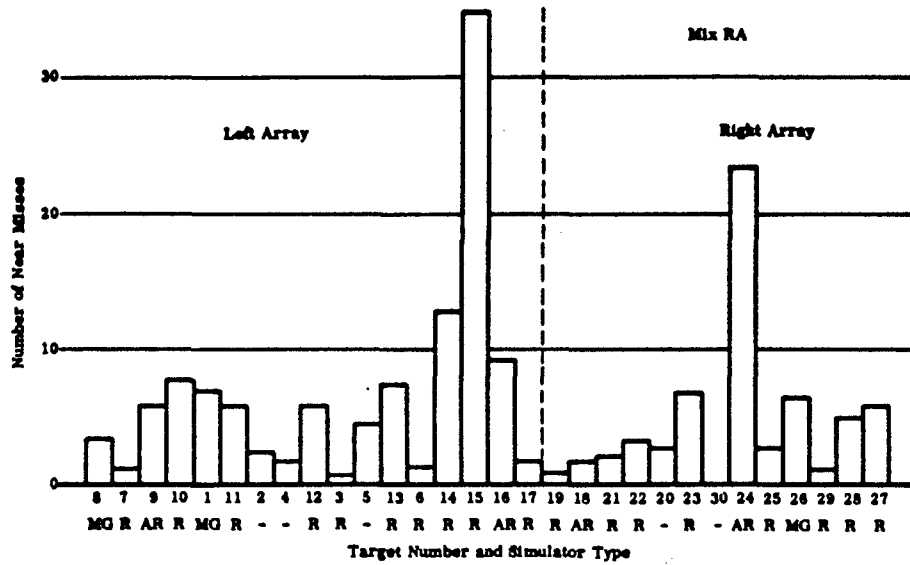
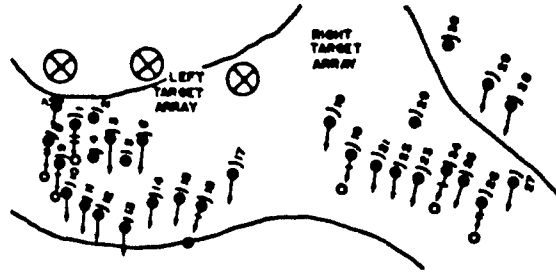

Figure 6-8 (Concluded)  
 NUMBER AND DISTRIBUTION OF NEAR MISSES--SITUATION 2

**3. Situation 4: Rifle Squad in Approach to Contact**

The approach to contact situation evaluated rifle squad weapon mixes in standing quickfire. This situation, in which the firers were time stressed, was designed to evaluate the pointing characteristics of small arms. It consisted of 40 targets programmed to appear in 12 events (or groups) of one to ten targets each. The 12 target groups were deployed at various points along a valley 430 meters long. The range from targets to the firers was 19 to 180 meters. Programmed target exposure times ran from 2 seconds to 10 seconds for some of the longer range targets (beyond 100 meters). Total programmed cumulative exposure time for all 40 targets was 2.996 minutes. The time required for each squad to complete the approach to contact course was 25 to 30 minutes.

Results are presented in subtables and graphically for cumulative exposure times, sustainability, number of targets hit, and number of total hits, across all events in Figure 6-9. Cumulative hits and percent of ammunition remaining as a function of time by range and event are presented in Figure 6-10. In addition, three sets of tables are presented, listing the rank order and associated standard scores for the following measures.

Table a -- Rank order of weapon mixes and associated standard scores for sum of target effects across all 12 events. This weights the event by range and number of targets unequally.

Table b -- Rank order of weapon mixes and associated standard scores with all events weighted equally. In effect, this table represents the average of the standard scores computed for each event, where Table a represents the standard scores computed from the sum of raw scores across all 40 targets (12 events).

Table c -- Rank order of weapon mixes and associated standard scores for the ambush situation (ten enemy targets at a range of 21 to 34 meters).

**Table a. SUM OF RAW SCORES ACROSS ALL TARGETS  
(Events Weighted Unequally)**

Target Effects Only			Overall Effectiveness*		
Rank	Mix	Standard Score	Rank	Mix	Standard Score
1	SC	61.4	1	CA	62.5
2	CA	59.3	2	UA	56.7
3	SB	52.8	3	RA	54.4
4	UA	51.7	4	SC	53.7
5	RA	50.6	5	CB	53.4
6	UB	49.6	6	SB	52.6
7	CB	45.2	7	UB	51.7
8	UD	44.2	8	SA	46.9
9	SA	44.2	9	UC	35.1
10	UC	40.9	10	UD	33.0

**Table b. AVERAGE OF 12 EVENT STANDARD SCORES  
(Events Weighted Equally)**

Target Effects Only			Overall Effectiveness*		
Rank	Mix	Standard Score	Rank	Mix	Standard Score
1	CA	62.9	1	CA	64.5
2	SC	57.0	2	UA	57.5
3	UA	54.4	3	UB	53.9
4	UB	53.4	4	SB	51.6
5	SB	51.3	5	RA	51.6
6	SA	46.7	6	SC	51.5
7	RA	46.4	7	CB	50.8
8	UD	44.2	8	SA	48.5
9	CB	42.4	9	UD	35.2
10	UC	41.5	10	UC	34.7

\* Sustainability weighted 1/3; Target effects 2/3

Table c. AMBUSH EVENT (10 TARGETS - 21 to 34 METERS)

Target Effects Only			Overall Effectiveness*		
Rank	Mix	Standard Score	Rank	Mix	Standard Score
1	SC	61.8	1	SC	59.6
2	UA	53.9	2	RA	56.0
3	SB	52.4	3	UA	55.7
4	SA	51.4	4	CA	55.6
5	UB	51.2	5	SA	52.7
6	CB	50.3	6	SB	52.1
7	CA	48.9	7	CB	52.0
8	RA	48.5	8	UB	48.6
9	UD	45.4	9	UD	43.5
10	UC	37.4	10	UC	25.0

\* Sustainability weighted 1/3; Target effects 2/3

Key:

- |                                     |   |
|-------------------------------------|---|
| UA - 9 M14 Rifles                   | SB - 7 Stoner Rifles and<br>2 Stoner AR |
| UD - 9 M14E2 Rifles                 | SC - 7 Stoner Rifles and<br>2 Stoner MG |
| UB - 7 M14 Rifles and<br>2 M14E2 AR | CA - 9 Colt Rifles                      |
| UC - 5 M14 Rifles and<br>2 M60 MG   | CB - 7 Colt Rifles and<br>2 Colt AR     |
| SA - 9 Stoner Rifles                | RA - 9 AK47 Rifles                      |

Mix RC results for Situation 4 are presented below.

CET	Near Misses	Percent Ammo Remaining	Targets Hit	Total Hits
2.17	--	52.00	26.66	38.60

EFFECTIVENESS MEASURES

COLLATERAL

**A Cumulative Exposure Times**

Mix	X̄ CET	SD	Standard Score z'
SC	1.95	.1	61.4
CA	1.97	.2	59.3
SB	2.03	.1	52.8
UA	2.04	.1	51.7
RA	2.05	.2	50.6
UB	2.06	.1	49.6
CB	2.10	.1	45.2
UD	2.11	.1	44.2
SA	2.11	.1	44.2
UC	2.14	.2	40.9
X̄	2.06		
SD	.03		

**B Number of Near Misses**

Mix	X̄ Near Misses	SD	Standard Score z'
X̄			
SD			

**C Sustainability (% Ammo Remaining)**

Mix	X̄ % Remaining	SD	Standard Score z'
CB	80.8	5.6	65.6
CA	80.2	4.8	68.8
UA	78.7	4.8	66.8
RA	75.8	2.8	62.1
UB	71.7	6.2	55.9
SA	69.3	5.7	52.2
SB	69.2	9.9	52.1
SC	60.2	7.4	38.3
UC	50.5	22.8	23.6
UD	42.0	9.0	10.6
X̄	67.8		
SD	13.11		

**D Number of Targets Hit**

Mix	X̄ Targets Hit	SD	Standard Score z'
SC	30.8	2.3	57.0
UB	30.7	2.1	56.5
SB	30.5	1.1	55.4
CA	30.4	2.3	54.8
UA	30.0	2.4	52.8
RA	29.8	4.3	51.7
SA	29.2	.9	48.8
UD	27.9	4.7	41.6
UC	27.8	2.8	41.0
CB	27.7	2.7	40.5
X̄	29.48		
SD	3.75		

**F Target Effects**

Mix	Standard Score Target Effects
SC	61.4
CA	59.3
SB	52.8
UA	51.7
RA	50.6
UB	49.6
CB	45.2
UD	44.2
SA	44.2
UC	40.9

**G Overall Effectiveness**

Mix	Overall Fire Effectiveness
CA	62.5
UA	56.7
RA	54.4
SC	53.7
CB	53.4
SB	52.6
UB	51.7
SA	46.9
UC	35.1
UD	33.0

**H Cumulative Exposure Times**

	SC	CA	SB	UA	RA	UB	CB	UD	SA	UC
SC		>.40	.10	.13	.14	.09	.03	.02	.02	.05
CA			.28	.26	.26	.22	.11	.09	.09	.11
SB				>.40	.38	.33	.12	.06	.04	.14
UA					>.40	>.40	.22	.18	.16	.19
RA						>.40	.30	.26	.25	.26
UB							.27	.22	.20	.22
CB								>.40	>.40	.37
UD									>.40	.39
SA										.39

**I**

**J Sustainability (% Ammo Remaining)**

	CB	CA	UA	RA	UB	SA	SB	SC	UC	UD
CB		>.40	.25	.05	.01	.004	.02	.001	.01	.001
CA			.30	.05	.02	.004	.02	.001	.01	.001
UA				.14	.03	.01	.03	.001	.01	.001
RA					.10	.02	.09	.001	.02	.001
UB						.26	.31	.01	.03	.001
SA							>.40	.02	.04	.001
SB								.05	.05	.001
SC									.17	.003
UC										.21

**K No. of Targets Hit**

	SC	UB	SB	CA	UA	RA	SA	UC	UD	CB
SC		>.40	.37	.37	.28	.32	.08	.11	.04	.03
UB			>.40	.40	.30	.34	.08	.12	.04	.04
SB				>.40	.33	.37	.03	.12	.03	.03
CA					>.40	>.40	.14	.14	.06	.05
UA						>.40	.24	.19	.09	.08
RA							.37	.26	.18	.18
SA								.27	.14	.12
UC									>.40	>.40
UD										>.40

**L**

Note: Standard Scores computed from raw scores using scores to three decimal places.

UA - 9 M14 Rifles  
 UB - 7 M14 Rifles/2 M14E2 AR  
 UC - 5 M14 Rifles/2 M60 MG  
 UD - 9 M14E2 Rifles  
 CA - 9 Colt Rifles  
 CB - 7 Colt Rifles/2 Colt AR  
 SA - 9 Stoner Rifles  
 SB - 7 Stoner Rifles/2 Stoner AR  
 SC - 7 Stoner Rifles/2 Stoner MG  
 RA - 9 AK47 Rifles

X̄  
SD  
CET  
z'

COLLATERAL PERFORMANCE MEASURES

Number of Targets Hit				Total Hits on Targets			
Mix	N Targets Hit	SD	Standard Score z'	Mix	N Hits	SD	Standard Score z'
SC	30.8	2.3	57.0	SC	53.8	9.1	83.5
UB	30.7	2.1	56.5	SB	50.0	7.3	67.7
SB	30.5	1.1	55.4	UA	49.6	8.7	66.0
CA	30.4	2.3	54.9	SA	47.4	8.3	56.8
UA	30.0	2.4	52.8	CA	47.3	6.2	56.4
RA	29.8	4.3	51.7	UB	44.5	5.9	44.7
SA	29.2	.9	48.5	RA	44.5	6.0	44.7
UC	27.9	4.7	41.6	CB	42.4	8.9	36.0
UD	27.8	2.8	41.0	UC	39.5	7.6	23.9
CB	27.7	2.7	40.5	UD	38.6	7.6	20.2
N	29.48			N	45.76		
SD	3.75			SD	4.80		

Number of Near Misses

Total Hits on Targets

	SC	SB	UA	SA	CA	UB	RA	CB	UC	UD
SC		.22	.21	.12	.10	.03	.05	.03	.01	.01
SB			>.40	.29	.26	.09	.11	.08	.02	.02
UA				.34	.31	.14	.16	.09	.04	.02
SA					>.40	.25	.27	.17	.06	.04
CA						.22	.24	.15	.04	.03
UB							>.40	.72	.12	.08
RA								.33	.13	.10
CB									.28	.22
UC										>.40

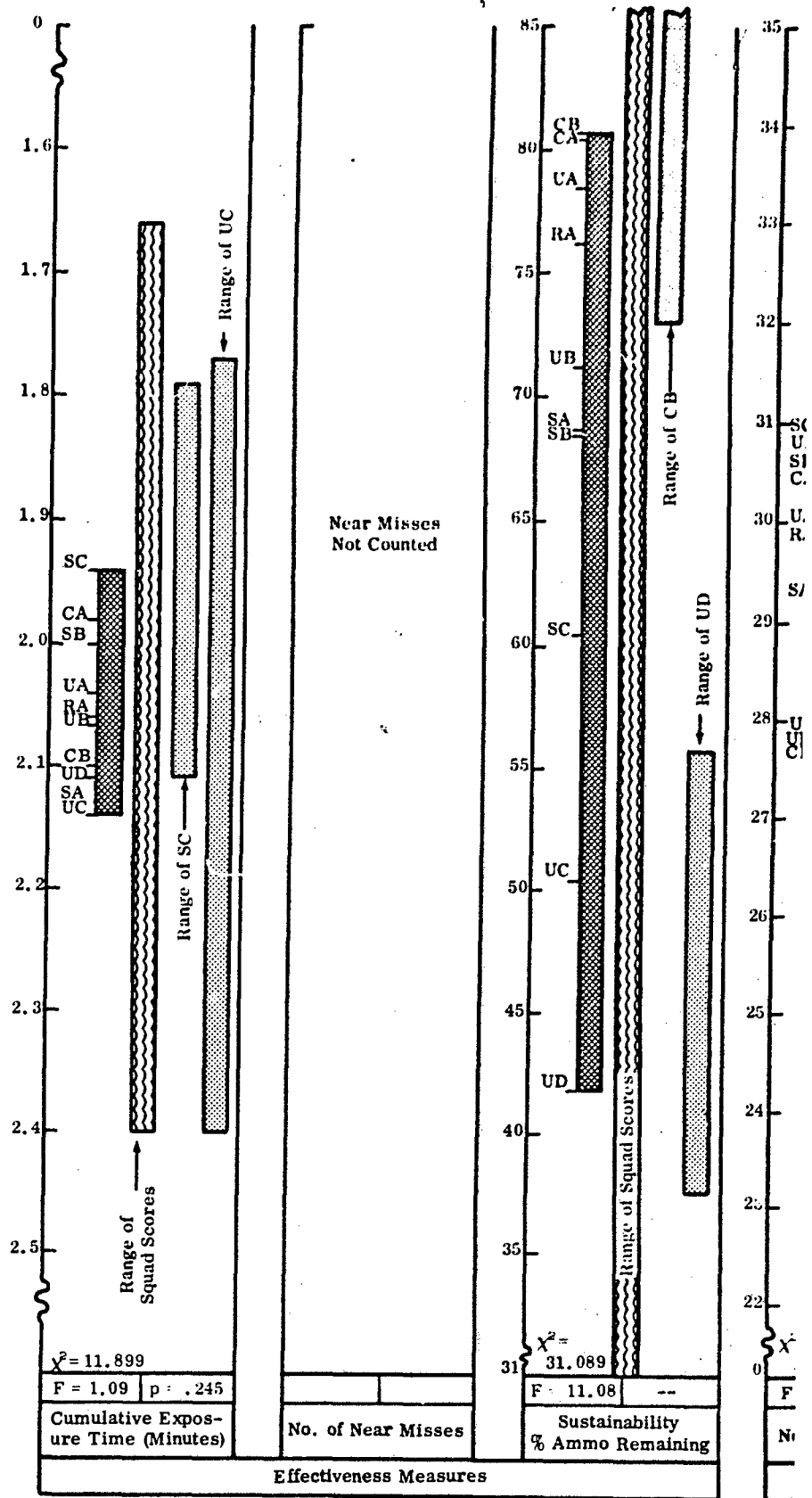

Stoner AR  
Stoner MG

N - Mean (Average)  
SD - Standard Deviation  
CET - Cumulative Exposure Time  
z' - Standard Score (X = 50, SD = 20)

Figure 6-9 SUMMARY OF RESULTS--S

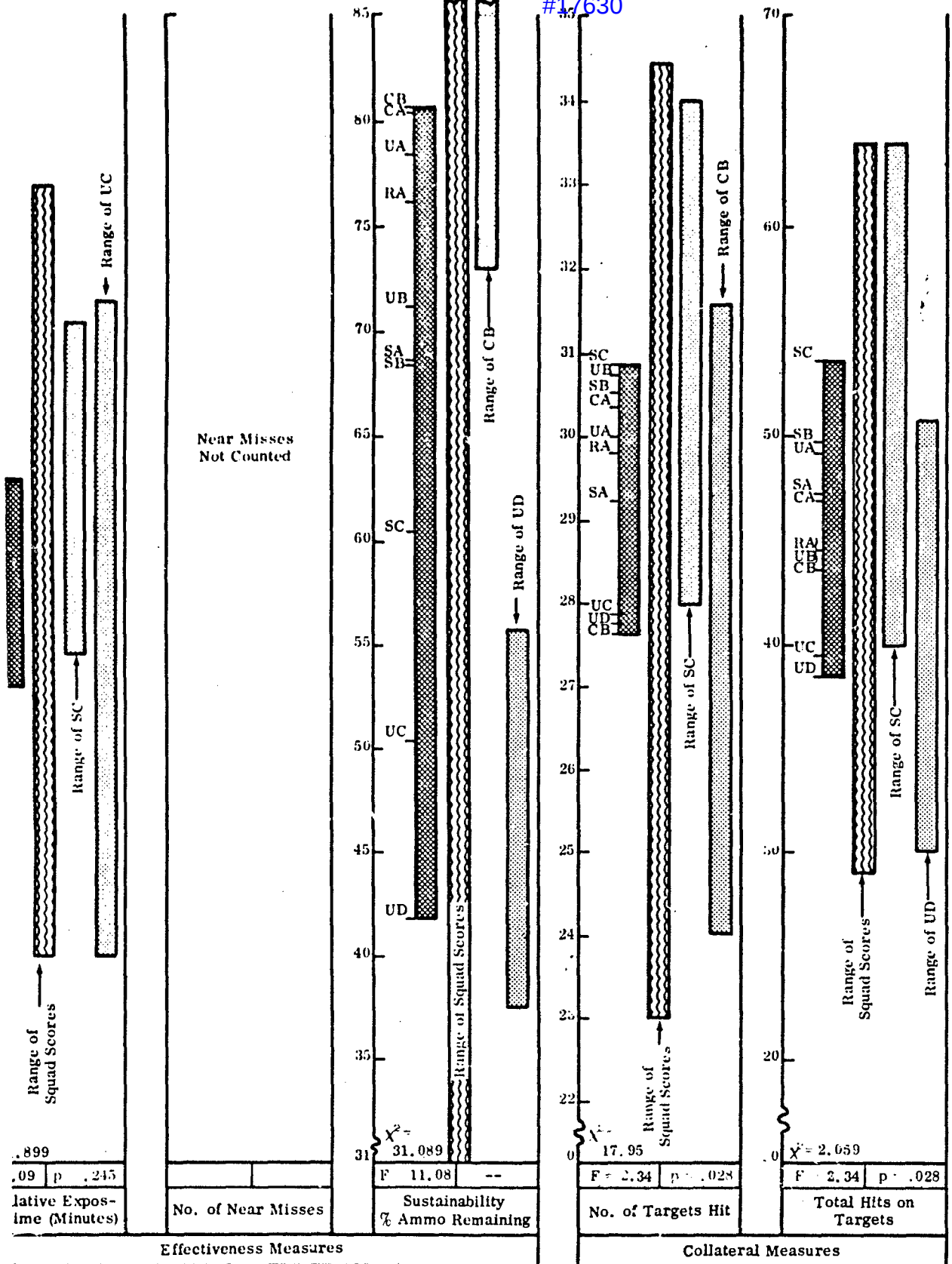

Figure 6-9 SUMMARY OF RESULTS--SITUATION 4

3



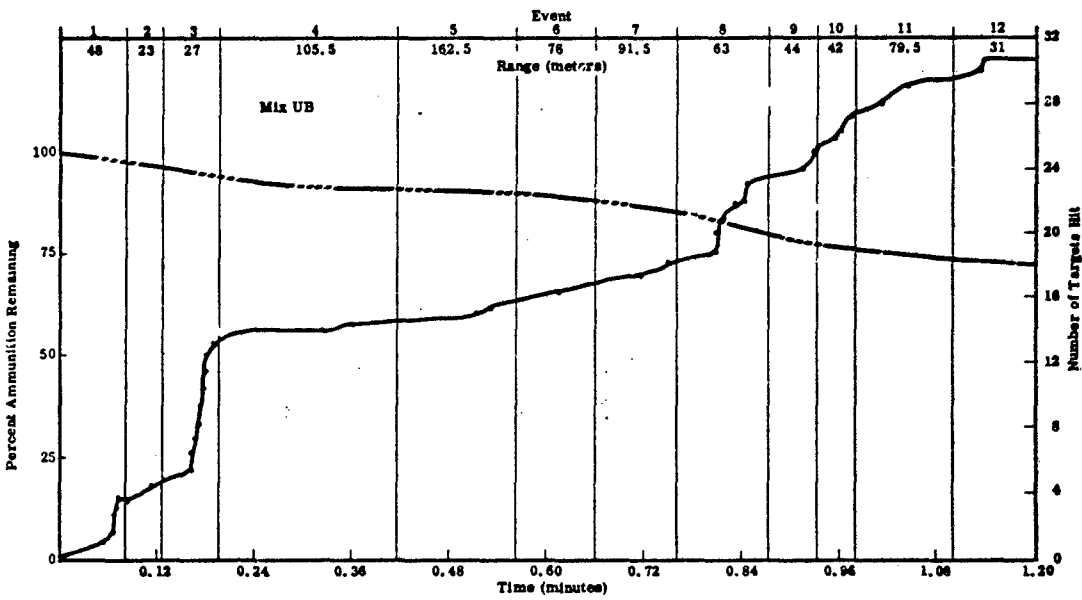
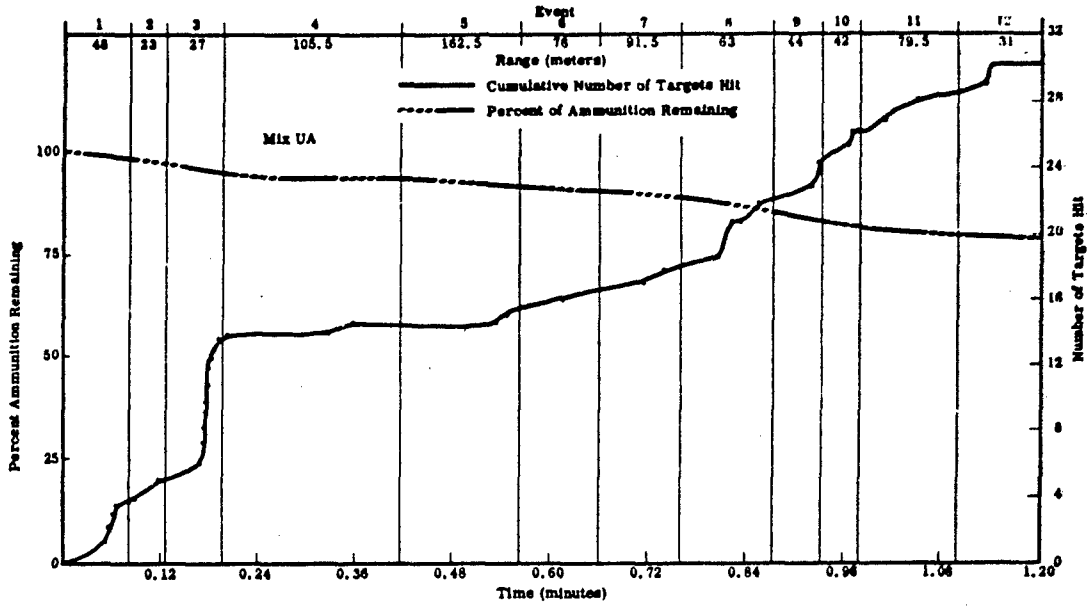

Figure 6-10 CUMULATIVE NUMBER OF TARGETS HIT AND PERCENT OF AMMUNITION REMAINING--SITUATION 4

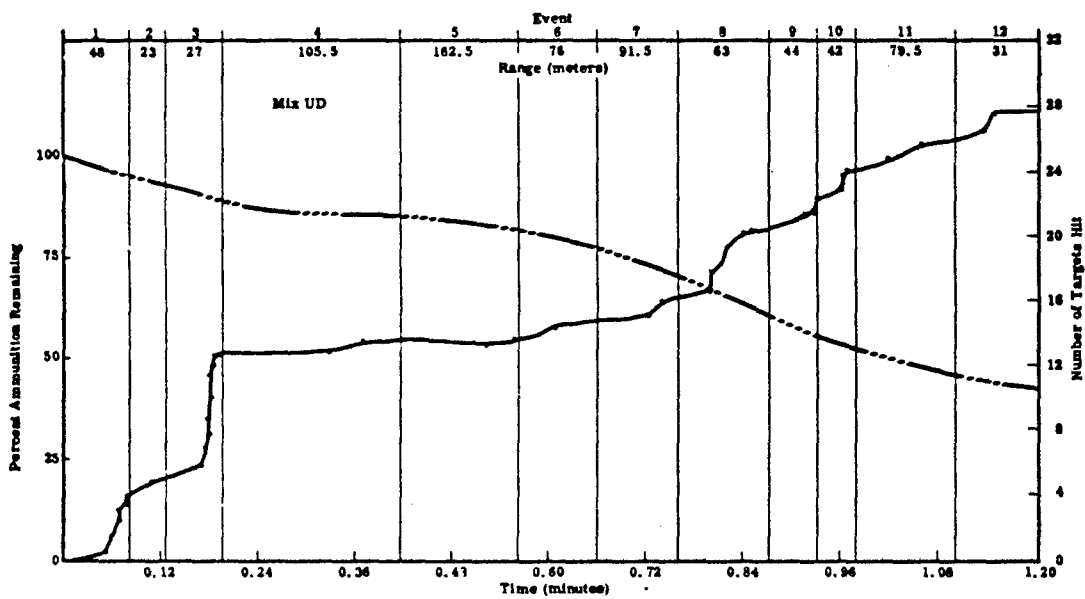
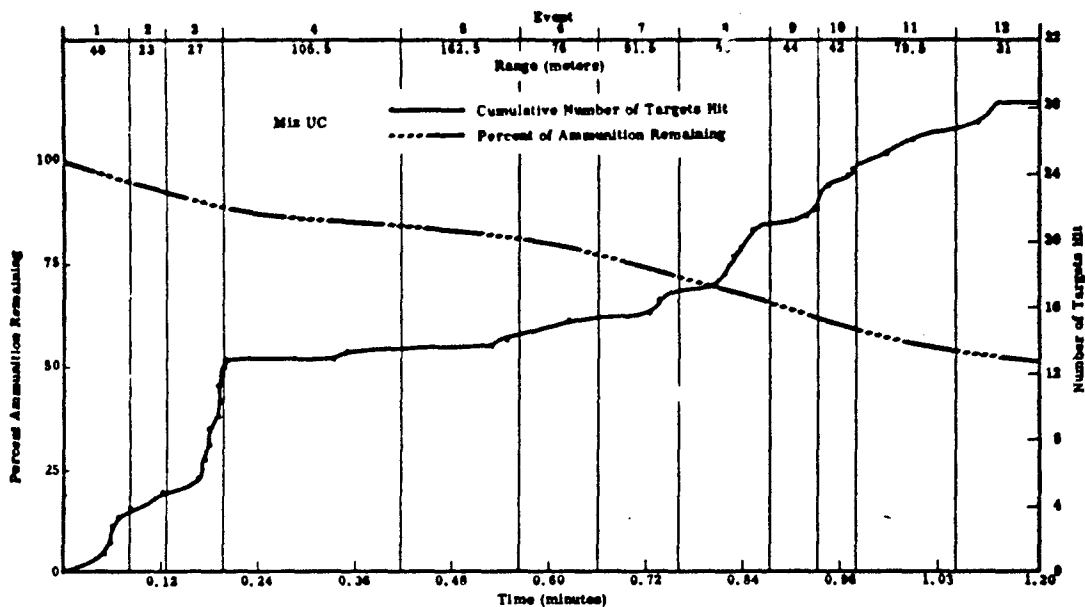

Figure 6-10 (Continued) CUMULATIVE NUMBER OF TARGETS HIT AND PERCENT OF AMMUNITION REMAINING--SITUATION 4

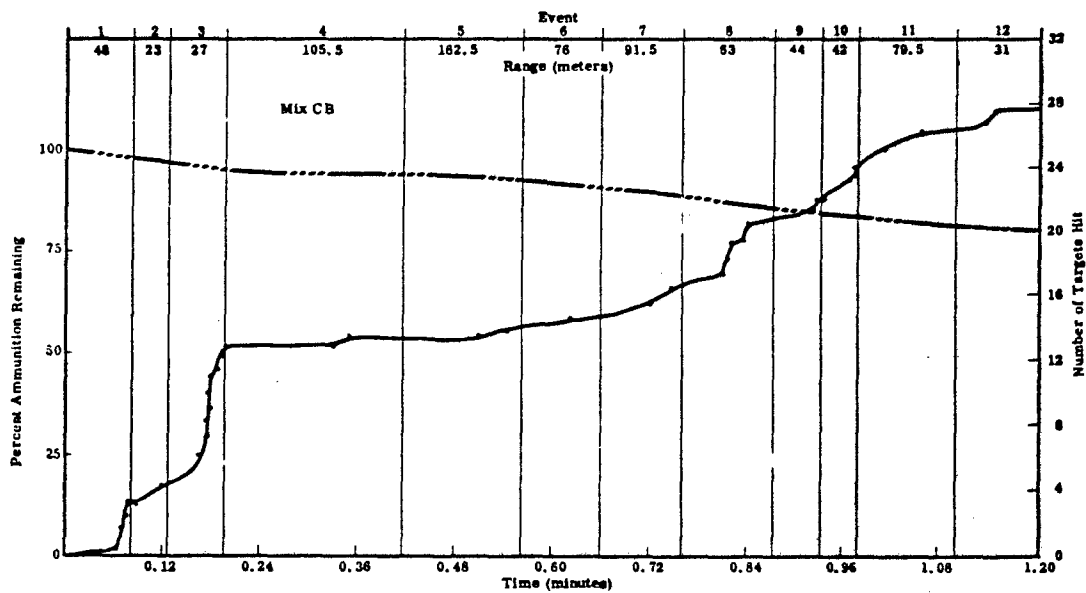
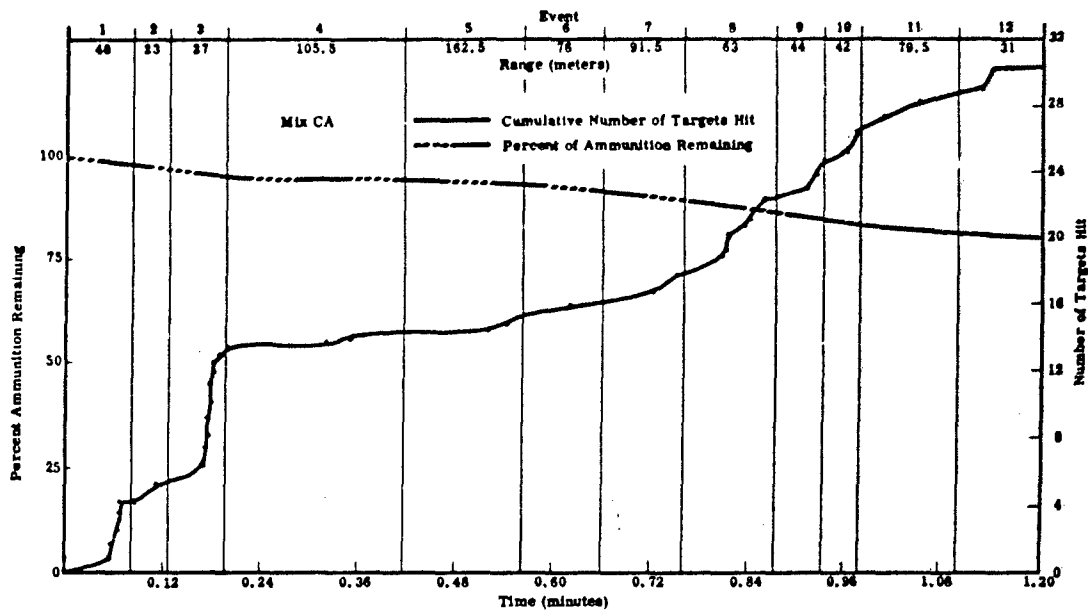

Figure 6-10 (Continued) CUMULATIVE NUMBER OF TARGETS HIT AND PERCENT OF AMMUNITION REMAINING--SITUATION 4

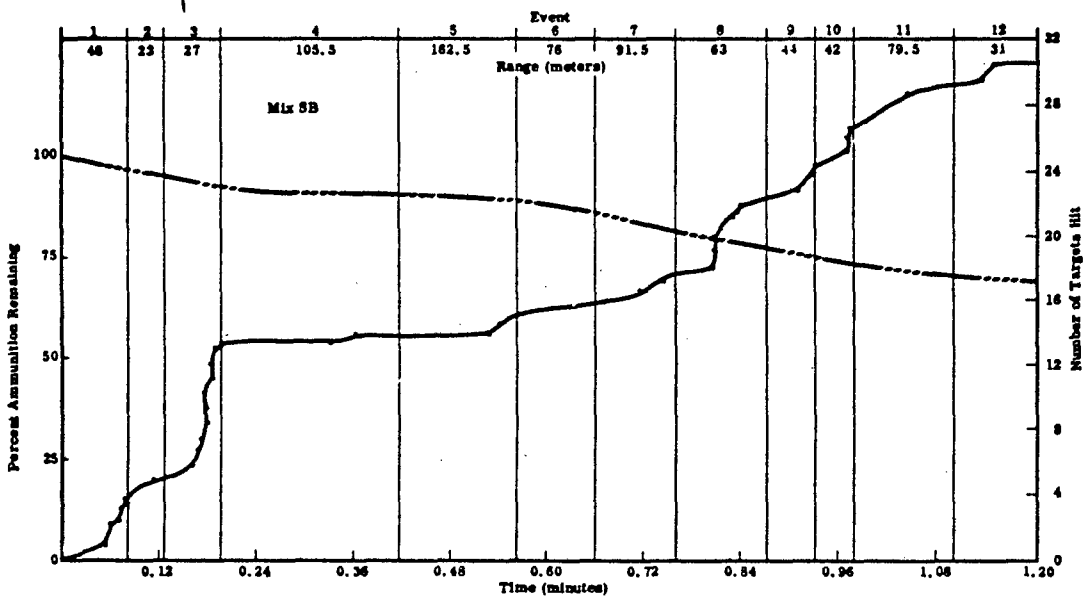
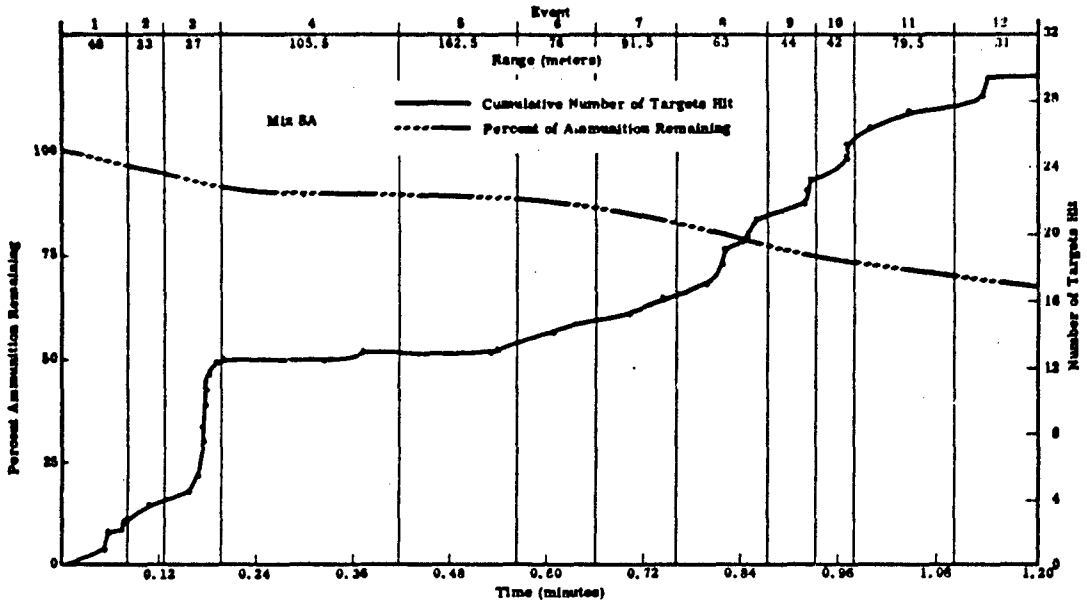

Figure 6-10 (Continued) CUMULATIVE NUMBER OF TARGETS HIT AND PERCENT OF AMMUNITION REMAINING--SITUATION 4

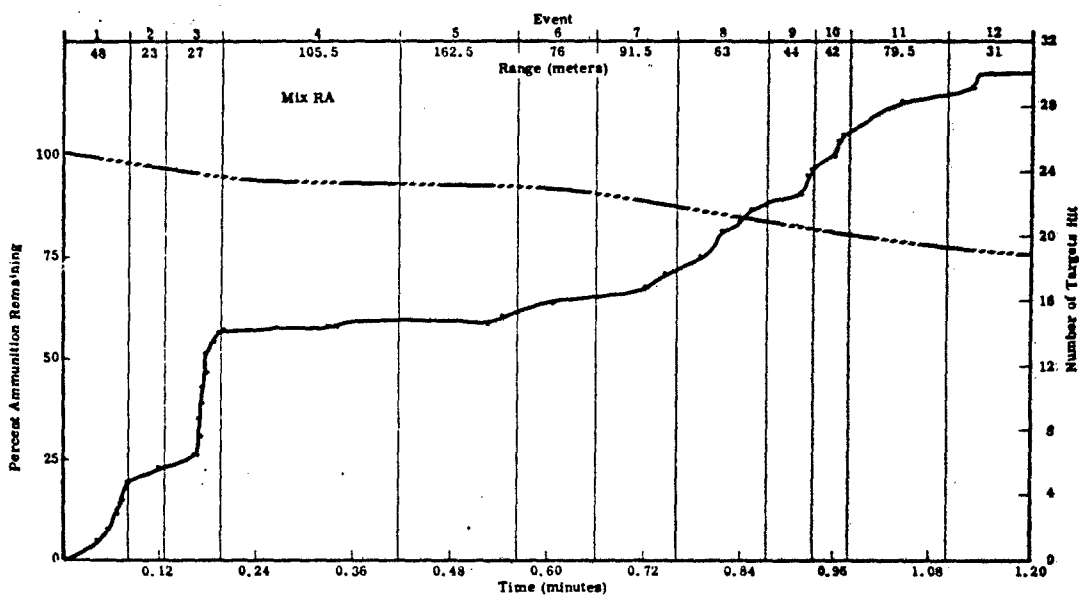
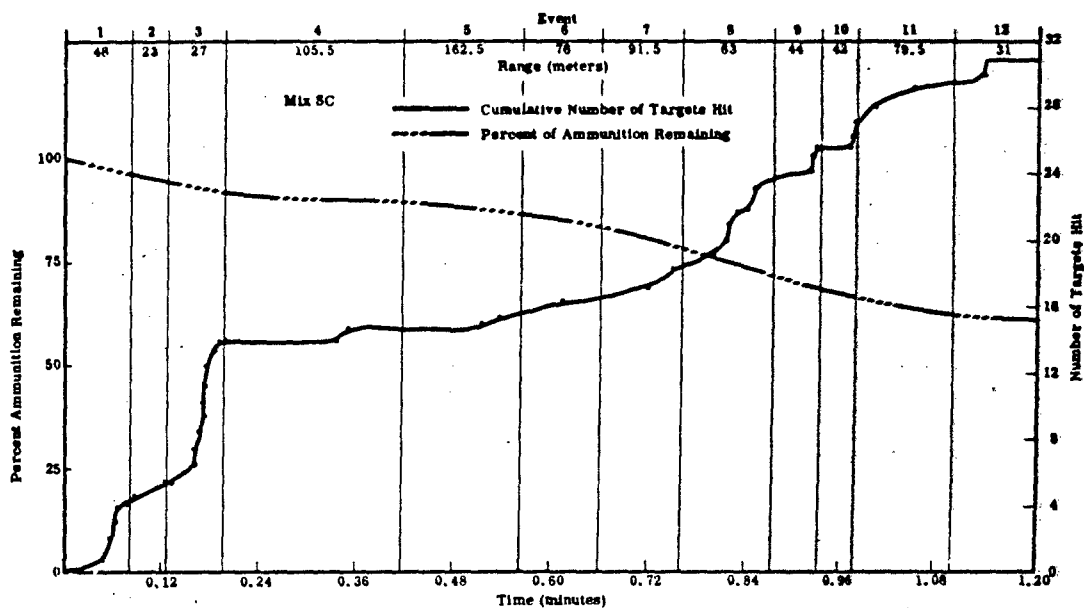

Figure 6-10 (Concluded) CUMULATIVE NUMBER OF TARGETS HIT AND PERCENT OF AMMUNITION REMAINING--SITUATION 4

4. Situation 5: Rifle Squad as a Base of Fire Supporting the Advance

Rifle squad weapon mixes fired from unprepared firing positions on two arrays of enemy targets. The duration of fire was 4 minutes, with the first 2 minutes devoted to an array of 14 enemy targets occupying an area 60 meters wide and 42 meters deep. The range of targets from the firers was 379 to 445 meters. The second 2 minutes of fire were delivered on an array of 13 targets occupying an area 45 meters wide and 62 meters deep, at ranges from the firers of 477 to 560 meters. The technique of distributed fire was used throughout the sector, with point fire used when targets were seen or weapon simulators gave specific cues to a target's location.

Arrays X and Y are presented separately following the overall results for the two arrays combined.

Results for Situation 5 are tabulated and presented graphically in Figures 6-11, 6-12, and 6-13. Figure 6-14 shows plots of cumulative average first hits as a function of time. For Mix RC, only cumulative number of hits is presented. Figure 6-15 shows the distribution of near misses by target.

The rank order of the ten mixes (other than Mix RC) with associated standard scores are given below.

Target Effects Only			Overall Effectiveness*		
Rank	Mix	Standard Score	Rank	Mix	Standard Score
1	SA	82.6	1	SA	74.5
2	SB	66.9	2	CB	67.9
3	SC	63.6	3	SB	63.8
4	CB	63.4	4	SC	57.5
5	UA	48.7	5	CA	50.1
6	UD	46.7	6	UA	47.5
7	UC	41.8	7	UD	41.5
8	CA	31.6	8	UC	36.44
9	UB	27.6	9	RA	30.77
10	RA	27.3	10	UB	30.1

\* Sustainability weighted 1/3; Target effects 2/3

**Key:**

UA	- 9 M14 Rifles	SB	- 7 Stoner Rifles and 2 Stoner AR
UD	- 9 M14E2 Rifles	SC	- 7 Stoner Rifles and 2 Stoner MG
UB	- 7 M14 Rifles and 2 M14E2 AR	CA	- 9 Colt Rifles
UC	- 5 M14 Rifles and 2 M60 MG	CB	- 7 Colt Rifles and 2 Colt AR
SA	- 9 Stoner Rifles	RA	- 9 AK47 Rifles
RC	- 7 AK47 Rifles and 2 RPD MG		

Mix RC results for Situation 5 are presented below.

CET	Near Misses	Percent Ammo Remaining	Targets Hit	Total Hits
41.41	167.80	51.60	5.72	6.12

**EFFECTIVENESS MEASURES**

**COLLATERAL PERFORMANCE**

Cumulative Exposure Times				Number of Near Misses				Sustainability (% Ammo Remaining)				
Mix	N	SD	Standard Score z'	Mix	N	SD	Standard Score z'	Mix	N	SD	Standard Score z'	Sustainability Time (Min)
SA	38.6	2.5	74.2	SA	207.3	43.4	90.9	CA	84.8	3.7	87.1	26.3
CB	38.6	3.3	74.0	SB	177.8	67.7	72.6	CB	79.0	4.9	77.1	19.0
SC	39.5	2.9	63.1	SC	164.2	63.0	64.1	SA	68.0	9.6	58.3	12.5
SB	39.7	4.3	61.2	CB	145.8	31.7	52.7	SB	67.6	8.1	57.6	12.3
UA	40.2	4.2	54.3	UA	130.3	51.6	43.1	SC	60.4	12.6	45.3	10.1
UD	40.3	2.4	53.2	UD	125.5	40.3	40.1	UA	60.3	5.4	45.1	10.1
UC	40.7	2.4	48.6	CA	121.5	51.5	37.6	RA	55.9	9.6	37.6	9.1
UB	42.5	2.2	27.2	RA	119.0	43.8	36.0	UB	54.4	4.3	35.1	8.8
CA	42.6	3.2	25.5	UC	117.1	29.7	34.9	UD	52.1	2.7	31.2	8.4
RA	43.2	2.3	18.5	UB	106.2	34.4	28.0	UC	48.8	10.3	25.6	7.8
$\bar{X}$	40.60			$\bar{X}$	141.48			$\bar{X}$	63.12			
$\sigma$	1.65			$\sigma$	32.17			$\sigma$	11.73			

Number of Targets Hit				Total
Mix	N	SD	Standard Score z'	Mix
SA	8.9	1.7	79.1	SA
CB	8.3	3.2	71.7	SB
SC	7.9	2.9	67.2	CB
SB	7.7	2.8	64.0	SC
UD	6.5	2.5	50.0	UD
UA	6.4	3.1	47.9	UA
UC	5.6	2.2	38.8	UC
CA	5.1	4.1	31.9	CA
UB	5.0	2.5	31.0	UB
RA	4.0	2.2	18.6	RA
$\bar{X}$	6.54			$\bar{X}$
$\sigma$	1.62			$\sigma$

**Target Effects**

Mix	Standard Score Target Effects
SA	82.5
SB	66.9
SC	63.6
CB	63.3
UA	48.7
UD	46.7
UC	41.7
CA	31.5
UB	27.6
RA	27.3

**Overall Effectiveness**

Mix	Overall Fire Effectiveness
SA	74.5
CB	67.9
SB	63.8
SC	57.5
UA	50.1
UD	47.5
UC	41.5
RA	36.4
UB	30.7
UB	30.1

**Cumulative Exposure Time**

	SA	CB	SC	SB	UA	UD	UC	UB	CA	RA
SA	>.40	.39	.31	.22	.13	.09	.01	.02	.008	
CB		.31	.32	.23	.16	.12	.02	.03	.02	
SC			>.40	.37	.30	.22	.04	.05	.02	
SB				>.40	.37	.31	.09	.10	.07	
UA					>.40	>.40	.14	.15	.10	
UD						>.40	.07	.10	.04	
UC							>.40	.11	.14	.06
UB								>.40	.31	
CA									>.40	.37

**Number of Near Miss**

	SA	SB	SC	CB	UA	UD	C
SA		.19	.10	.01	.01	.004	.04
CB			.36	.16	.10	.07	.07
SC				.27	.17	.12	.1
CB					.27	.18	.1
UA						>.40	.3
UD							>.4
CA							
RA							
UC							

**Sustainability (% Ammo Remaining)**

	CA	CB	SA	SB	SC	UA	RA	UB	UD	UC
CA		.02	.002	.000	.001	.000	.001	.000	.000	.000
CB			.02	.009	.004	.000	.001	.000	.000	.000
SA				>.40	.13	.05	.03	.004	.002	.004
SB					.13	.05	.03	.004	.000	.004
SC						>.40	.26	.15	.08	.06
UA							.18	.03	.005	.02
RA								.37	.19	.14
UB									.15	.13
UD										.24

**No. of Targets Hit**

	SA	CB	SC	SB	UD	UA	UC	CA	UB	RA
SA		.35	.25	.19	.04	.06	.01	.03	.005	.003
CB			>.40	.36	.16	.16	.07	.09	.04	.02
SC				>.40	.19	.19	.08	.10	.05	.02
SB					.24	.23	.10	.12	.06	.02
UD						>.40	.26	.24	.15	.06
UA							.33	.28	.21	.10
UC								.39	.33	.13
CA									>.40	.31
UB										.26

**Total Hits on Target**

	SA	SB	CB	SC	UD	UA	I
SA		.24	.15	.15	.02	.02	.0
SB			>.40	>.40	.15	.13	.0
CB				>.40	.16	.14	.0
SC					.17	.15	.0
UD						>.40	.1
UA							.3
UC							
CA							
UB							

Note: Standard Scores computed from raw scores using scores to three decimal places.

UA - 9 M14 Rifles  
 UB - 7 M14 Rifles/2 M14E2 AR  
 UC - 5 M14 Rifles/2 M60 MG  
 UD - 9 M14E2 Rifles  
 CA - 9 Colt Rifles

CB - 7 Colt Rifles/2 Colt AR  
 SA - 9 Stoner Rifles  
 SB - 7 Stoner Rifles/2 Stoner AR  
 SC - 7 Stoner Rifles/2 Stoner MG  
 RA - 9 AK47 Rifles

$\bar{X}$  - Mean (Average)  
 SD - Standard Devia  
 CET - Cumulative Ex  
 z' - Standard Score



**COLLATERAL PERFORMANCE MEASURES**

Number of Targets Hit				Total Hits on Targets			
Mix	X Targets Hit	SD	Standard Score z'	Mix	X Hits	SD	Standard Score z'
SA	8.9	1.7	79.1	SA	10.2	2.4	93.2
CB	8.3	3.2	71.7	SB	8.8	3.9	69.2
SC	7.9	2.9	67.2	CB	8.5	3.2	65.6
SB	7.7	2.8	64.0	SC	8.4	3.3	65.2
UD	6.5	2.5	50.0	UD	6.7	2.7	47.9
UA	6.4	3.1	47.9	UA	6.4	3.1	44.6
UC	5.6	2.2	38.8	UC	5.6	2.2	37.2
CA	5.1	4.1	31.9	CA	5.2	4.3	33.2
UB	5.0	2.5	31.0	UB	5.0	2.5	30.9
RA	4.0	2.3	18.6	RA	4.3	2.3	22.9
$\bar{X}$	6.54			$\bar{X}$	6.91		
$\sigma$	1.62			$\sigma$	1.98		

**Number of Near Misses**

	SA	SB	SC	CB	UA	UD	CA	RA	UC	UB
SA		.19	.10	.01	.01	.004	.006	.005	.002	.001
SB			.36	.16	.10	.07	.07	.07	.04	.02
SC				.27	.17	.12	.12	.11	.07	.04
CB					.27	.18	.18	.14	.07	.03
UA						>.40	.39	.35	.30	.18
UD							>.40	>.40	.35	.20
CA								>.40	>.40	.28
RA									>.40	.30
UC										.28

**Total Hits on Targets**

	SA	SB	CB	SC	UD	UA	UC	CA	UB	RA
SA		.24	.15	.15	.02	.02	.004	.02	.03	.02
SB			>.40	>.40	.15	.13	.06	.08	.04	.02
CB				>.40	.16	.14	.05	.09	.03	.02
SC					.17	.15	.06	.09	.04	.02
UD						>.40	.24	.25	.14	.07
UA							.33	.31	.21	.12
UC								>.40	.33	.16
CA									>.40	.32
UB										.30

lit AR  
Stoner AR  
Stoner MG

$\bar{X}$  - Mean (Average)  
SD - Standard Deviation  
CET - Cumulative Exposure Time  
z' - Standard Score (X = 50, SD = 20)

6-51

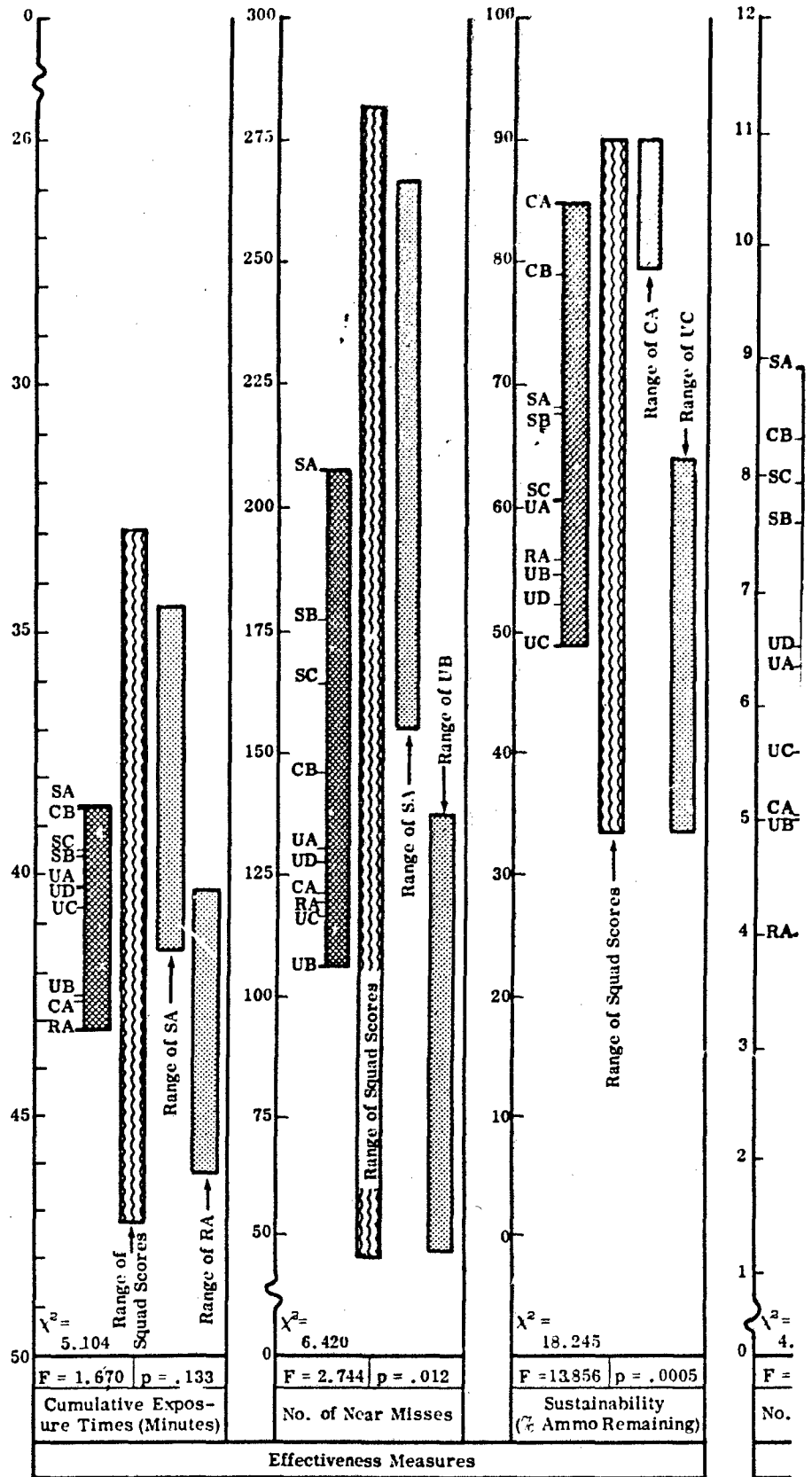

Figure 6-11 SUMMARY OF RESULTS--S

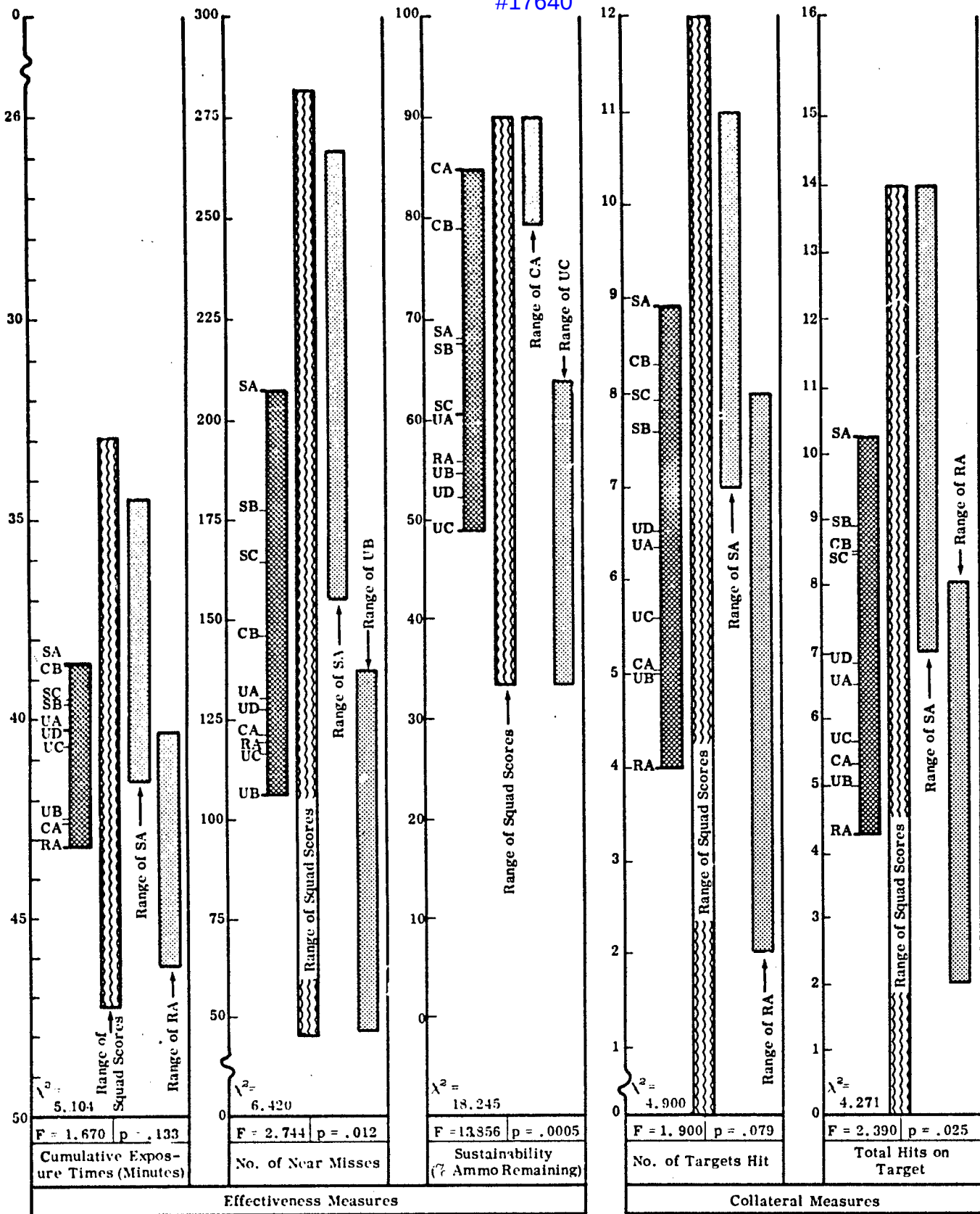

Figure 6-11 SUMMARY OF RESULTS--SITUATION 5

**BLANK PAGE**

EFFECTIVENESS MEASURES

COLLATERAL PERFORMANCE

Cumulative Exposure Times

Mix	$\bar{X}$ CET	SD	Standard Score $z'$
CB	18.6	1.9	76.9
SA	18.6	1.7	72.1
SB	19.2	1.9	65.6
UA	19.4	2.0	59.8
UD	19.8	2.0	52.2
SC	19.9	2.5	50.5
UC	20.2	2.4	44.3
UB	20.7	1.4	34.6
CA	20.8	1.8	31.8
RA	21.8	1.3	12.7
$\bar{X}$	19.93		
$\sigma$	.993		

Number of Near Misses

Mix	$\bar{X}$ Near Misses	SD	Standard Score $z'$
SA	125.7	48.5	82.4
SB	120.3	48.8	77.2
CB	109.0	25.2	66.3
SC	100.5	43.0	58.1
UA	89.9	38.9	47.9
CA	83.3	35.1	41.5
UD	80.0	29.1	38.3
RA	72.2	27.6	30.8
UC	70.3	26.4	29.0
UB	70.0	22.8	28.7
$\bar{X}$	92.13		
$\sigma$	20.73		

Sustainability (Ammo Remaining)

Mix	$\bar{X}$ of Ammo Remaining	SD	Standard Score $z'$
CA	85.9	3.8	87.4
CB	80.6	5.8	77.0
SA	71.1	5.1	59.6
SB	70.6	7.0	57.5
SC	65.3	12.0	47.2
UA	63.7	7.5	44.1
RA	59.0	7.4	35.0
UD	57.8	2.7	30.8
UB	57.5	4.5	32.1
UC	55.7	6.2	28.6
$\bar{X}$	66.71		
$\sigma$	10.28		

Number of Targets Hit

Mix	$\bar{X}$ Targets Hit	SD	Standard Score $z'$
CB	5.3	2.1	79.0
SB	5.0	0.9	75.1
SA	4.6	1.0	64.7
SC	4.4	1.8	62.0
UA	4.1	2.1	54.9
UD	3.6	1.9	46.3
CA	3.2	2.2	38.4
UB	3.0	1.5	33.9
UC	2.8	2.0	30.0
RA	2.2	1.6	18.2
$\bar{X}$	3.82		
$\sigma$	1.016		

Target Effects

Mix	Standard Score Target Effects
SA	77.3
CB	71.6
SB	71.4
SC	54.3
UA	53.9
UD	45.3
UC	36.7
CA	36.7
UB	31.7
RA	21.7

Overall Effectiveness

Mix	Overall Fire Effectiveness
CB	73.4
SA	71.0
SB	66.8
CA	53.6
SC	51.9
UA	50.6
UD	41.0
UC	34.0
UB	31.8
RA	26.2

Cumulative Exposure Time

	CB	SA	SB	UA	UD	SC	UC	UB	CA	RA
CB	>.40	.31	.28	.26	.11	.11	.03	.03	.006	
SA		.38	.33	.19	.14	.14	.03	.04	.003	
SB			>.40	.29	.23	.21	.07	.08	.02	
UA				>.40	.37	.31	.18	.17	.06	
UD					>.40	.39	.20	.19	.05	
SC						>.40	.18	.18	.03	
UC							.34	.31	.11	
UB								>.40	.10	
CA									.17	

Number of Near

	SA	SB	CB	SC	UA	CA
SA	>.40	.24	.18	.10	.06	
SB		.29	.21	.11	.07	
CB			.34	.17	.05	
SC				.33	.23	
UA					.38	
CA						
UD						
RA						
UC						

Sustainability (Ammo Remaining)

	CA	CB	SA	SB	SC	UA	RA	UD	UB	UC
CA		.05	.000	.000	.002	.000	.001	.000	.000	.000
CB			.008	.01	.01	.001	.001	.000	.000	.000
SA				>.40	.15	.04	.006	.000	.000	.000
SB					.19	.07	.02	.002	.003	.003
SC						>.40	.17	.08	.09	.06
UA							.16	.05	.06	.04
RA								.36	.35	.23
UD									>.40	.24
UB										.29

No. of Targets Hit

	CB	SB	SA	SC	UA	UD	CA	UB	UC	RA
CB		.38	.23	.23	.16	.09	.06	.03	.03	.02
SB			.23	.26	.17	.08	.05	.01	.02	.004
SA				>.40	.30	.16	.10	.03	.04	.01
SC					.38	.24	.16	.09	.09	.03
UA						.36	.26	.17	.15	.07
UD							.37	.27	.24	.11
CA								>.40	.37	.20
UB									>.40	.21
UC										.30

Total Hits on T

	SB	CB	SA	SC	UA	UD
SB		>.40	.32	.24	.09	.06
CB			.37	.29	.14	.11
SA				.39	.19	.15
SC					.28	.23
UA						>.40
UD						
CA						
UB						
UC						

Note: Standard Scores computed from raw scores using scores to three decimal places.

UA - 9 M14 Rifles  
 UB - 7 M14 Rifles/2 M14E2 AR  
 UC - 5 M14 Rifles/2 M60 MG  
 UD - 9 M14E2 Rifles  
 CA - 9 Colt Rifles

CB - 7 Colt Rifles/2 Colt AR  
 SA - 9 Stoner Rifles  
 SB - 7 Stoner Rifles/2 Stoner AR  
 SC - 7 Stoner Rifles/2 Stoner MG  
 RA - 9 AK47 Rifles

$\bar{X}$  - Mean (Average)  
 SD - Standard Deviation  
 CET - Cumulative Exposure Time  
 $z'$  - Standard Score

COLLATERAL PERFORMANCE MEASURES

Number of Targets Hit				Total Hits on Targets			
Mix	$\bar{X}$ Targets Hit	SD	Standard Score z'	Mix	$\bar{X}$ Hits	SD	Standard Score z'
CB	5.3	2.1	79.0	SB	5.5	1.4	75.9
SB	5.0	0.9	73.1	CB	5.5	2.2	75.4
3A	4.8	1.0	64.7	SA	5.1	1.7	68.6
3C	4.4	1.8	62.0	SC	4.8	2.0	63.5
JA	4.1	2.1	54.9	UA	4.1	2.1	48.9
JD	3.6	1.9	46.3	UD	3.8	2.3	47.1
CA	3.2	2.2	38.4	CA	3.2	2.5	37.4
JB	3.0	1.5	33.9	UB	3.0	1.5	33.5
JC	2.8	2.0	30.0	UC	2.8	2.0	30.1
JA	2.2	1.6	18.2	RA	2.2	1.6	20.0
$\bar{X}$	3.82			$\bar{X}$	3.99		
$\sigma$	1.016			$\sigma$	1.18		

Number of Near Misses

	SA	SB	CB	SC	UA	CA	UD	RA	UC	UB
A	>.40	.24	.18	.10	.06	.04	.03	.02	.02	
B			.29	.21	.11	.07	.04	.03	.02	.02
B				.34	.17	.09	.05	.02	.02	.01
C					.33	.23	.18	.12	.09	.08
A						.38	.32	.21	.17	.15
A							>.40	.29	.24	.23
D								.33	.28	.26
A									>.40	>.40
C										>.40

Total Hits on Targets

	SB	CB	SA	SC	UA	UD	CA	UB	UC	RA
3	>.40	.32	.24	.09	.08	.04	.009	.01	.004	
B			.37	.29	.14	.11	.07	.02	.03	.01
1				.39	.19	.15	.09	.03	.03	.01
2					.28	.23	.14	.06	.06	.02
1						>.40	.27	.17	.15	.07
2							.35	.25	.22	.11
1								>.40	.38	.23
3									>.40	.21
2										.30

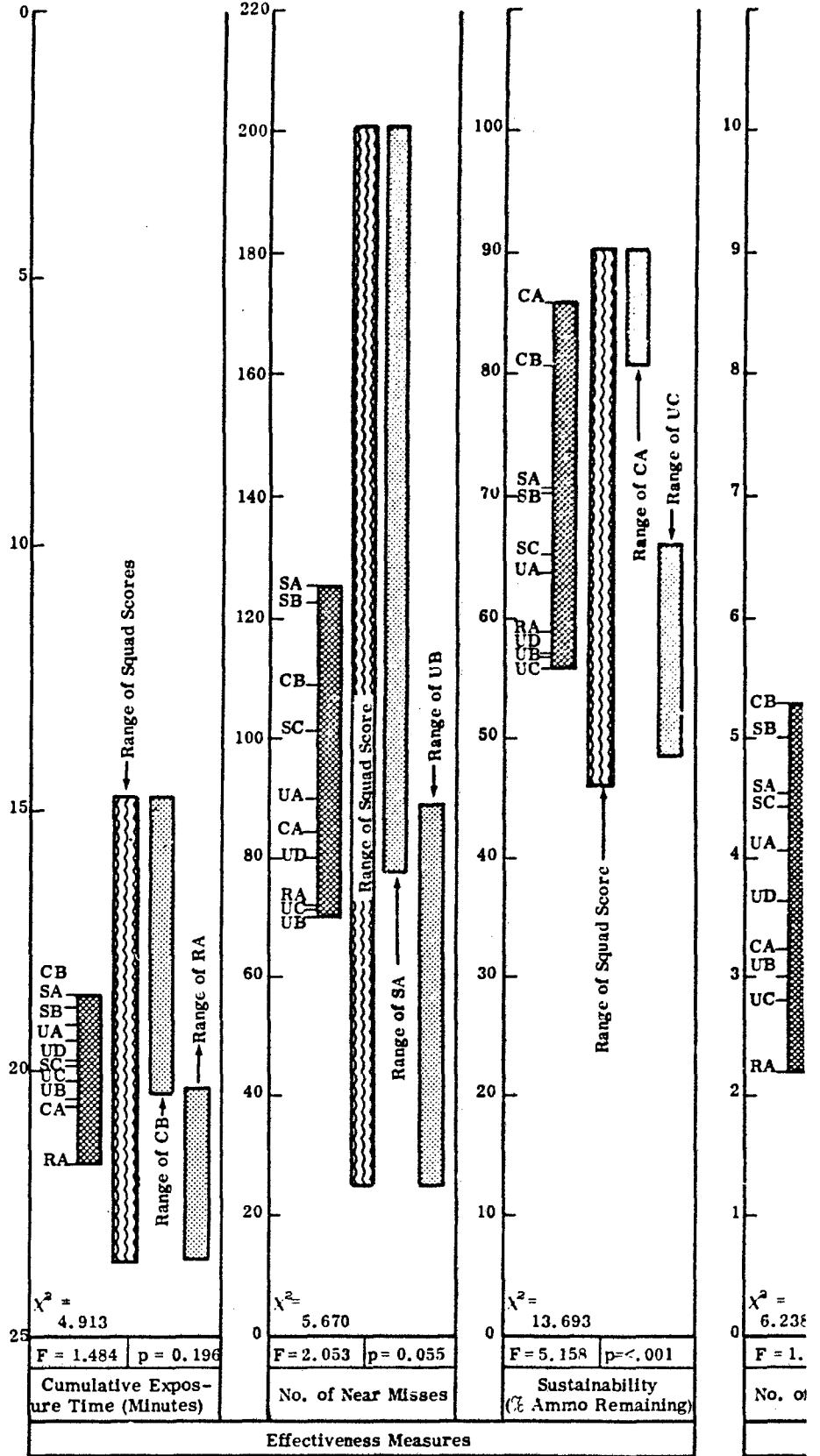

MR  $\bar{X}$  - Mean (Average)  
 SD - Standard Deviation  
 CET - Cumulative Exposure Time  
 z' - Standard Score ( $\bar{X} = 50, SD = 20$ )  
 per AR  
 per MG

Figure 6-12 SUMMARY OF RESULTS--SITUATION

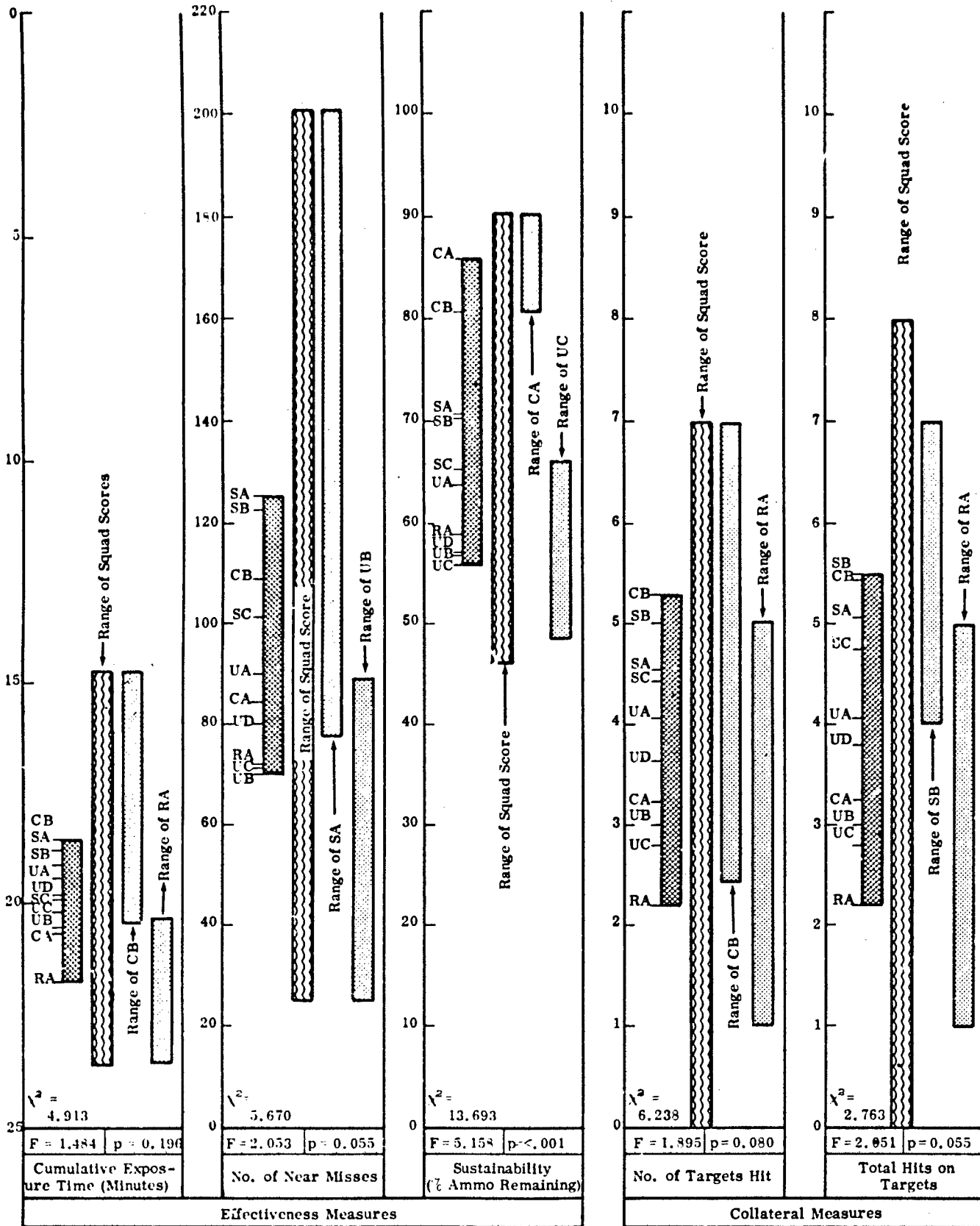

Figure 6-12 SUMMARY OF RESULTS--SITUATION 5 (ARRAY X)

**BLANK PAGE**

EFFECTIVENESS MEASURES

A Cumulative Exposure Times				B Number of Near Misses				C Sustainability (# Ammo Remaining)				
Mix	$\bar{X}$ CET	SD	Standard Score $z'$	Mix	$\bar{X}$ Near Misses	SD	Standard Score $z'$	Mix	$\bar{X}$ Remaining	SD	Standard Score $z'$	Sustainability Time (Min)
SC	19.7	1.7	75.1	SA	81.7	11.2	94.7	CA	83.7	4.0	86.5	24.5
SA	19.8	2.1	72.5	SC	63.7	23.0	69.8	CB	77.5	4.3	77.1	17.9
CB	20.0	1.8	65.8	SB	57.5	27.8	61.3	SA	65.0	13.9	58.1	11.4
UA	20.4	2.0	57.0	UC	46.8	21.1	46.5	SB	64.6	9.3	57.5	11.3
UC	20.5	2.2	53.4	RA	46.8	20.9	46.4	UA	56.9	6.4	45.8	9.3
SB	20.5	2.9	53.1	UD	45.5	23.8	44.6	SC	55.5	13.8	43.8	9.0
UD	20.5	2.9	53.1	UA	40.5	16.1	37.7	RA	52.7	12.9	39.5	8.5
RA	21.4	1.5	30.6	CA	38.2	20.7	34.5	UB	52.1	5.3	38.5	8.4
UB	21.8	1.3	20.3	CB	36.8	18.4	32.6	UD	46.4	5.2	30.0	7.5
CA	21.8	1.8	20.3	UB	36.2	17.2	31.7	UC	42.0	14.9	23.2	6.9
$\bar{X}$	20.64			$\bar{X}$	49.36			$\bar{X}$	59.63			
$\sigma$	0.77			$\sigma$	14.44			$\sigma$	13.19			

COLLATERAL PE

D Number of Targets Hit			
Mix	$\bar{X}$ Targets Hit	SD	Standard Score $z'$
SA	4.3	1.4	91.3
SC	3.5	1.2	69.8
CB	3.0	1.8	56.9
UD	2.9	1.0	54.3
UC	2.8	1.7	52.5
SB	2.7	2.0	48.4
UA	2.3	1.5	38.8
UB	2.0	1.4	31.0
CA	2.0	2.0	31.0
RA	1.8	0.8	25.9
$\bar{X}$	2.73		
$\sigma$	0.77		

Target Effects Overall Effectiveness

F Target Effects		G Overall Effectiveness	
Mix	Standard Score Target Effects	Mix	Overall Fire Effectiveness
SA	83.6	SA	75.1
SC	72.5	SC	62.9
SB	57.2	CB	58.5
UC	50.0	SB	57.3
CB	49.2	CA	47.1
UD	48.9	UA	46.8
UA	47.4	UD	42.6
RA	38.5	UC	41.0
CA	27.4	RA	38.8
UB	26.0	UB	30.2

Cumulative Exposure Time

H Cumulative Exposure Time										I Number of Targets Hit				
SC	SA	CB	UA	UC	SB	UD	RA	UB	CA	SA	SC	SB	UC	
SC	>.40	.34	.27	.22	.25	.13	.05	.02	.03	SA		.06	.04	.004
SA		>.40	.33	.28	.31	.22	.09	.04	.05	SC			.34	.11
CB			.39	.35	.37	.28	.11	.04	.06	SB				.24
UA				>.40	>.40	>.40	.22	.12	.14	UC				
UC					>.40	>.40	.29	.13	.15	RA				
SB						>.40	.28	.17	.19	UD				
UD							.13	.04	.08	UA				
RA								.32	.25	CA				
UB									>.40	CB				

Sustainability (# Ammo Remaining)

J Sustainability (# Ammo Remaining)										
CA	CB	SA	SB	UA	SC	RA	UB	UD	UC	UC
CA		.02	.005	.000	.000	.000	.001	.000	.000	.000
CB			.03	.007	.000	.003	.001	.000	.000	.000
SA				>.40	.11	.03	.69	.03	.007	.61
SB					.07	.11	.06	.01	.002	.006
UA						>.40	.25	.10	.006	.03
SC							.37	.29	.08	.07
RA								>.40	.15	.12
UB									.05	.08
UD										.25

No. of Targets Hit

K No. of Targets Hit										L Total					
SA	SC	CB	UD	UC	SB	UA	UB	CA	RA	SA	SC	SB	CB		
SA		.15	.09	.04	.07	.06	.02	.01	.02	.004	SA		.08	.10	.04
SC			.29	.19	.23	.20	.09	.04	.08	.02	SC			>.40	.25
CB				>.40	>.40	.38	.25	.16	.19	.11	SB				>.40
UD					>.40	>.40	.22	.12	.17	.04	CB				
UC						>.40	.29	.19	.23	.13	UD				
SB							.37	.26	.29	.19	UC				
UA								.37	.39	.27	UA				
UB									>.40	>.40	UB				
CA										>.40	CA				

Note: Standard Scores computed from raw scores using scores to three decimal places.

UA - 9 M14 Rifles                      CB - 7 Colt Rifles/2 Colt AR                       $\bar{X}$  - M  
 UB - 7 M14 Rifles/2 M14E2 AR                      SA - 9 Stoner Rifles                      SD - St  
 UC - 5 M14 Rifles/2 M60 MG                      SB - 7 Stoner Rifles/2 Stoner AR                      CET - Ct  
 UD - 9 M14E2 Rifles                      SC - 7 Stoner Rifles/2 Stoner MG                       $z'$  - St  
 CA - 9 Colt Rifles                      RA - 9 AK47 Rifles



COLLATERAL PERFORMANCE MEASURES

Number of Targets Hit				Total Hits on Targets					
D	Mix	X Targets Hit	SD	Standard Score Z'	E	Mix	Z Hits	SD	Standard Score Z'
SC	3.5	1.2	69.8	SC	3.7	1.4	65.2		
CB	3.0	1.8	56.9	SB	3.3	2.7	58.3		
UD	2.9	1.0	54.3	CB	3.0	1.8	51.6		
UC	2.8	1.7	52.5	UD	2.9	1.0	49.6		
SB	2.7	2.0	48.4	UC	2.8	1.7	48.2		
UA	2.3	1.5	38.8	UA	2.3	1.5	37.4		
UB	2.0	1.4	31.0	RA	2.0	0.7	31.3		
CA	2.0	2.0	31.0	UB	2.0	1.4	31.3		
RA	1.8	0.8	25.9	CA	2.0	2.0	31.3		
$\bar{X}$	2.73			$\bar{X}$	2.92				
$\sigma$	0.77			$\sigma$	0.98				

Number of Near Misses

CA	SA	SC	SB	UC	RA	UD	UA	CA	CB	UB
.03 SA		.06	.04	.004	.004	.004	.001	.001	.000	.001
.05 SC			.34	.11	.12	.11	.04	.04	.02	.02
.06 SB				.24	.25	.22	.11	.10	.08	.07
.14 UC					>.40	>.40	.29	.24	.20	.18
.15 RA						>.40	.29	.26	.21	.19
.19 UD							.34	.29	.25	.23
.08 UA								>.40	.36	.33
.25 CA									>.40	>.40
.40 CB										>.40

Total Hits on Targets

RA	SA	SC	SB	CB	UD	UC	UA	RA	UB	CA
004 SA		.08	.10	.04	.02	.03	.01	.004	.005	.01
02 SC			>.40	.25	.15	.19	.07	.02	.03	.06
11 SB				>.40	.36	.36	.22	.15	.15	.18
04 CB					>.40	>.40	.25	.14	.16	.19
13 UD						>.40	.22	.07	.12	.17
19 UC							.29	.17	.19	.23
27 UA								.35	.37	.39
40 RA									>.40	>.40
40 UB										>.40

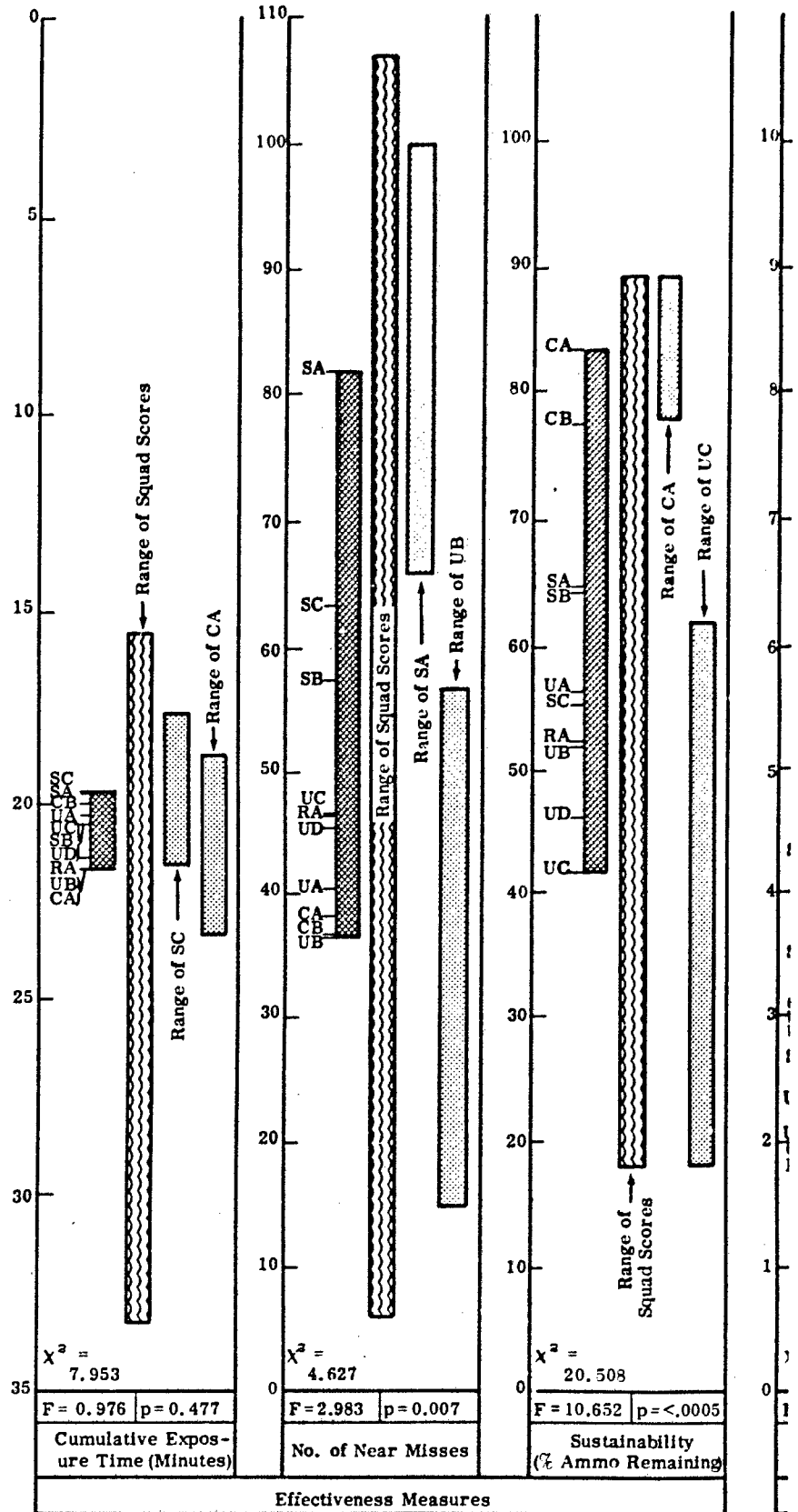

2 Colt AR  
 s  
 s/2 Stoner AR  
 s/2 Stoner MG

$\bar{X}$  - Mean (Average)  
 SD - Standard Deviation  
 CET - Cumulative Exposure Time  
 z' - Standard Score ( $\bar{X} = 50$ ,  $SD = 20$ )

Figure 6-13 SUMMARY OF RESULTS--SITU

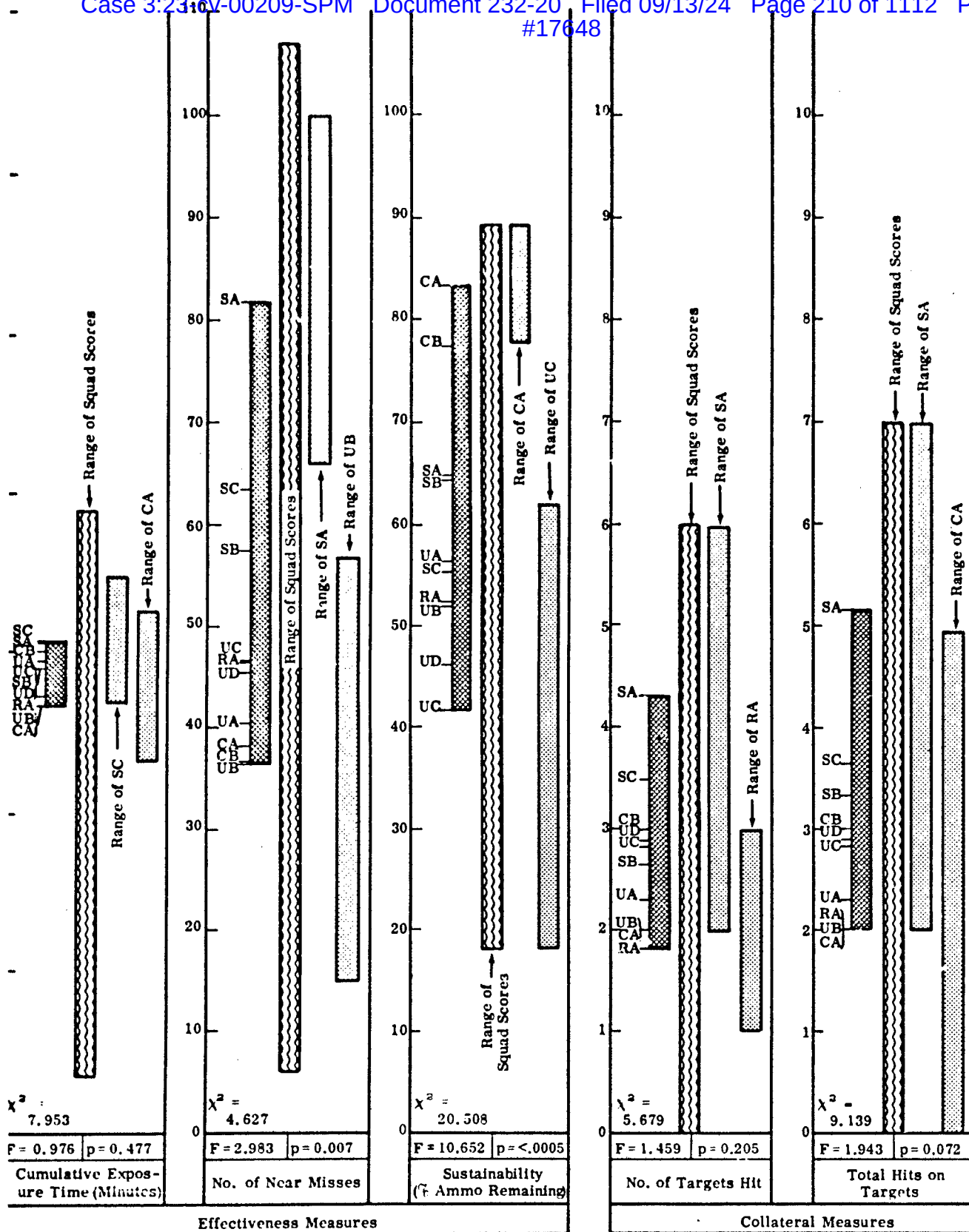

Figure 6-13 SUMMARY OF RESULTS--SITUATION 5 (ARRAY Y)

**BLANK PAGE**

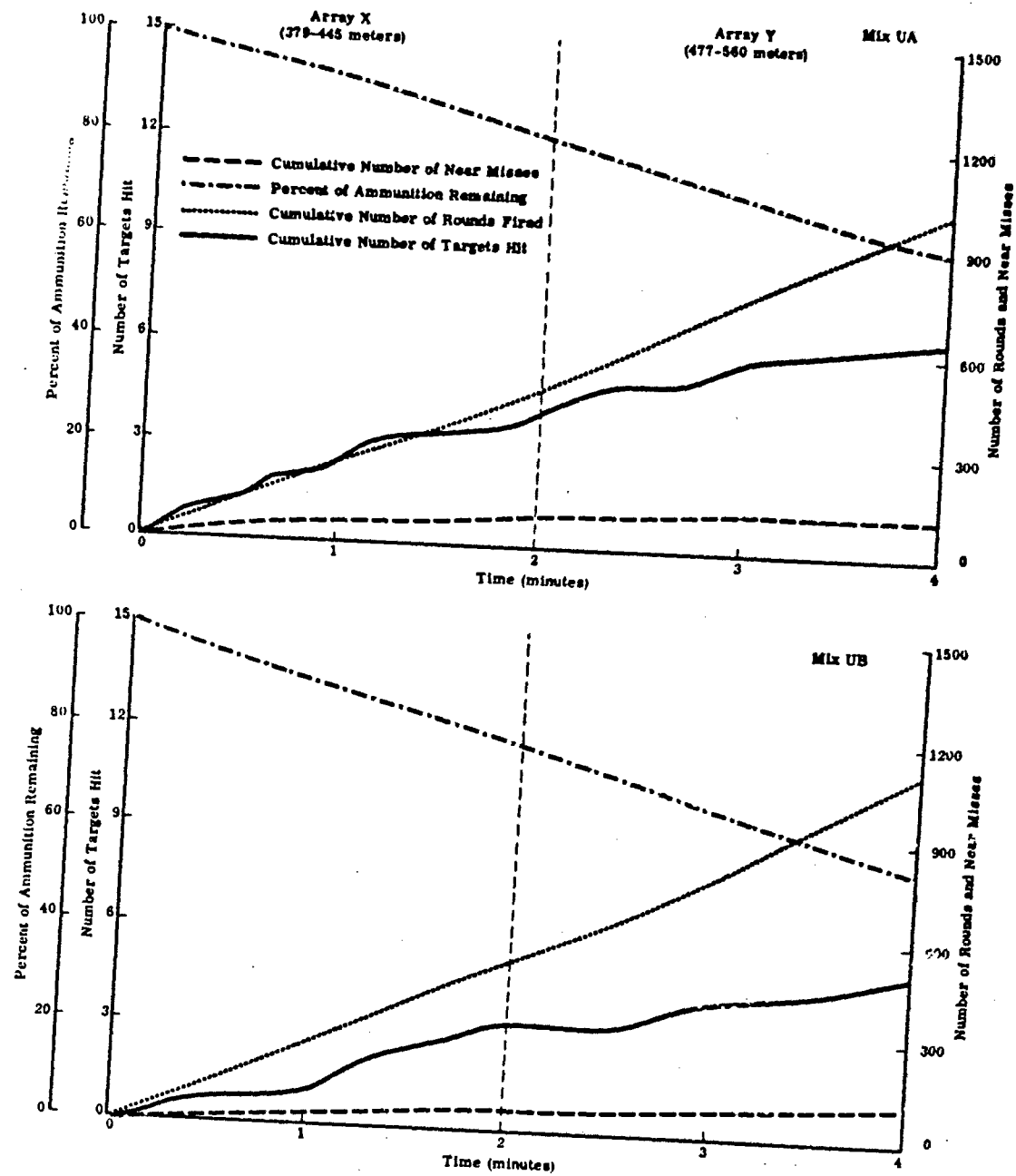

Figure 6-14 CUMULATIVE NUMBER OF ROUNDS FIRED, TARGETS HIT, NEAR MISSES, AND PERCENT OF AMMUNITION REMAINING--SITUATION 5

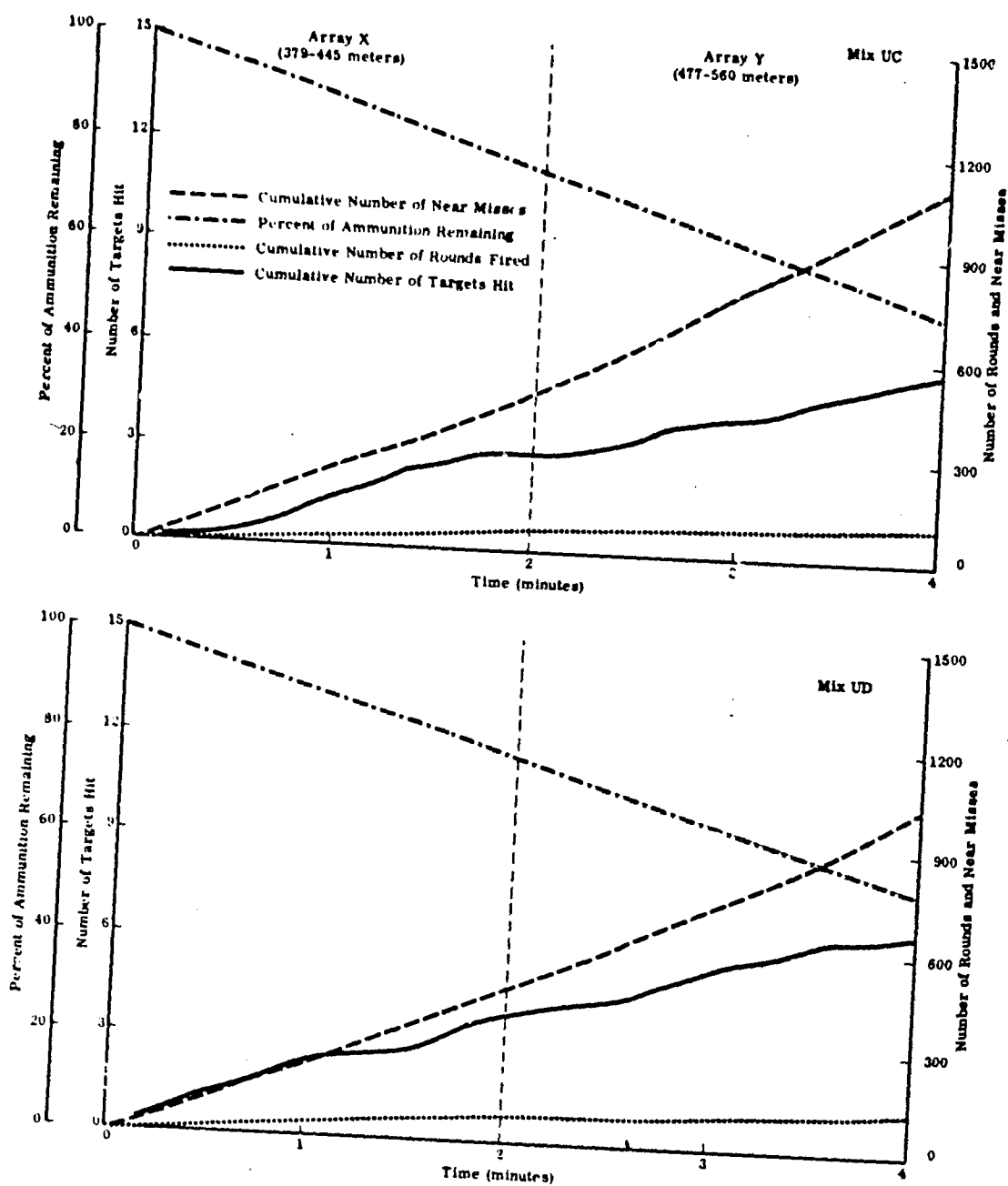

Figure 6-14 (Continued)  
 CUMULATIVE NUMBER OF ROUNDS FIRED, TARGETS HIT, NEAR MISSES,  
 AND PERCENT OF AMMUNITION REMAINING--SITUATION 5

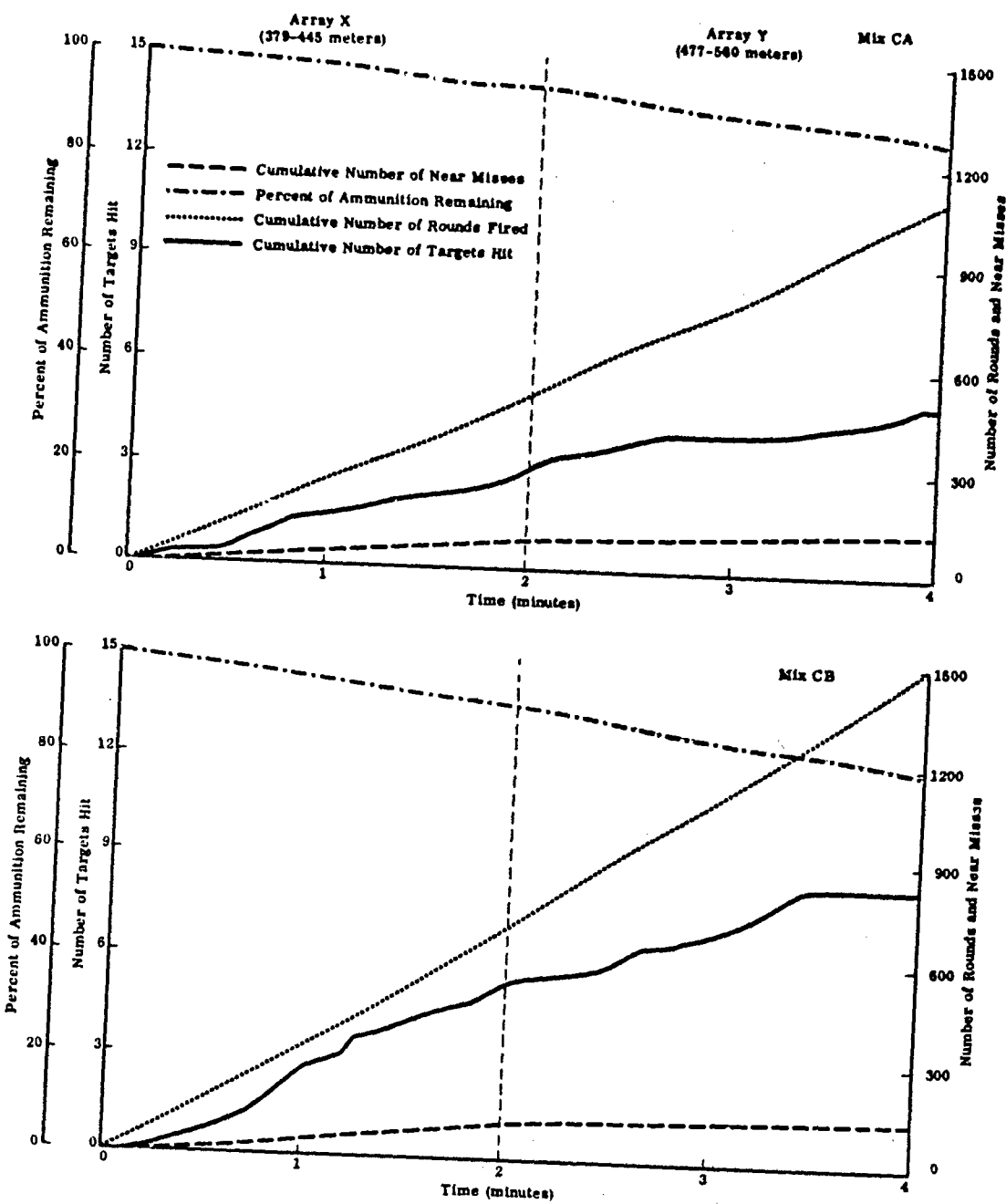

Figure 6-14 (Continued)  
 CUMULATIVE NUMBER OF ROUNDS FIRED, TARGETS HIT, NEAR MISSES,  
 AND PERCENT OF AMMUNITION REMAINING--SITUATION 5

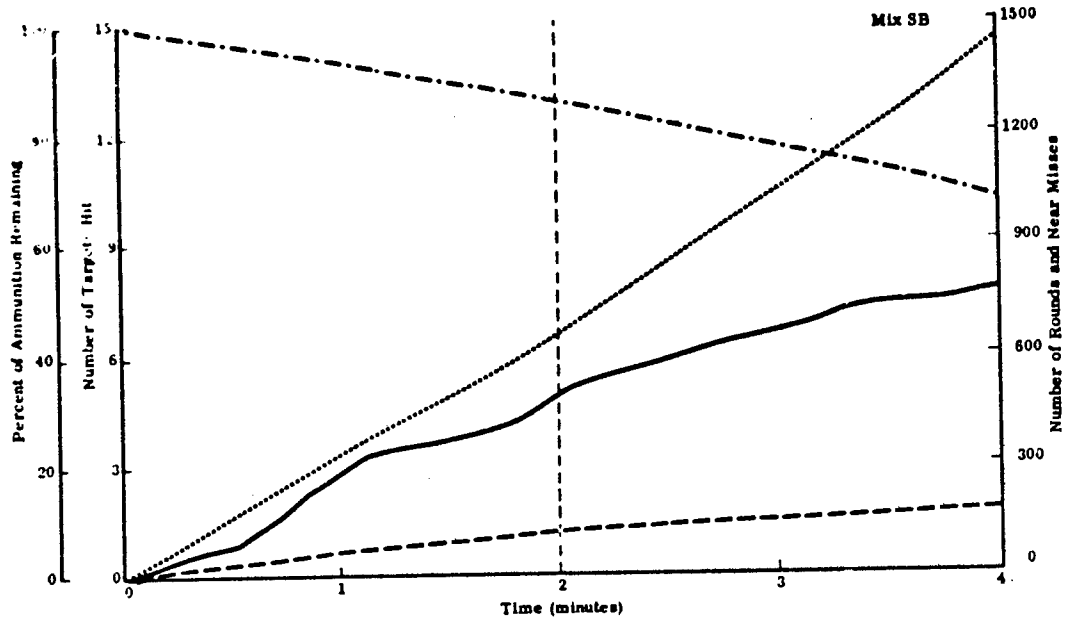
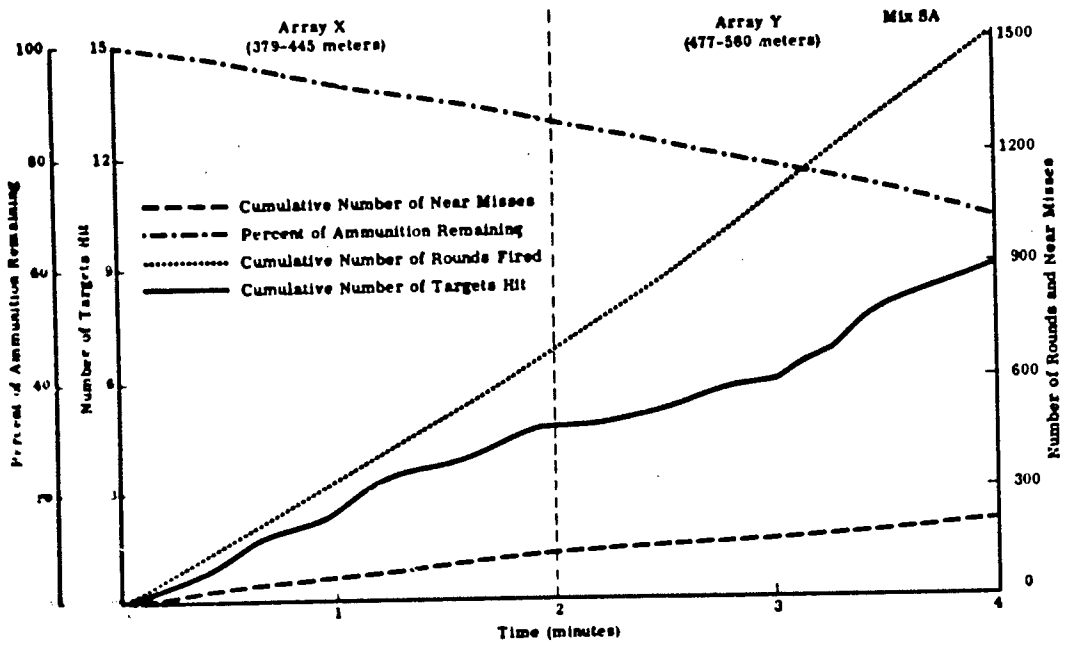

Figure 6-14 (Continued)

CUMULATIVE NUMBER OF ROUNDS FIRED, TARGETS HIT, NEAR MISSES, AND PERCENT OF AMMUNITION REMAINING--SITUATION 5

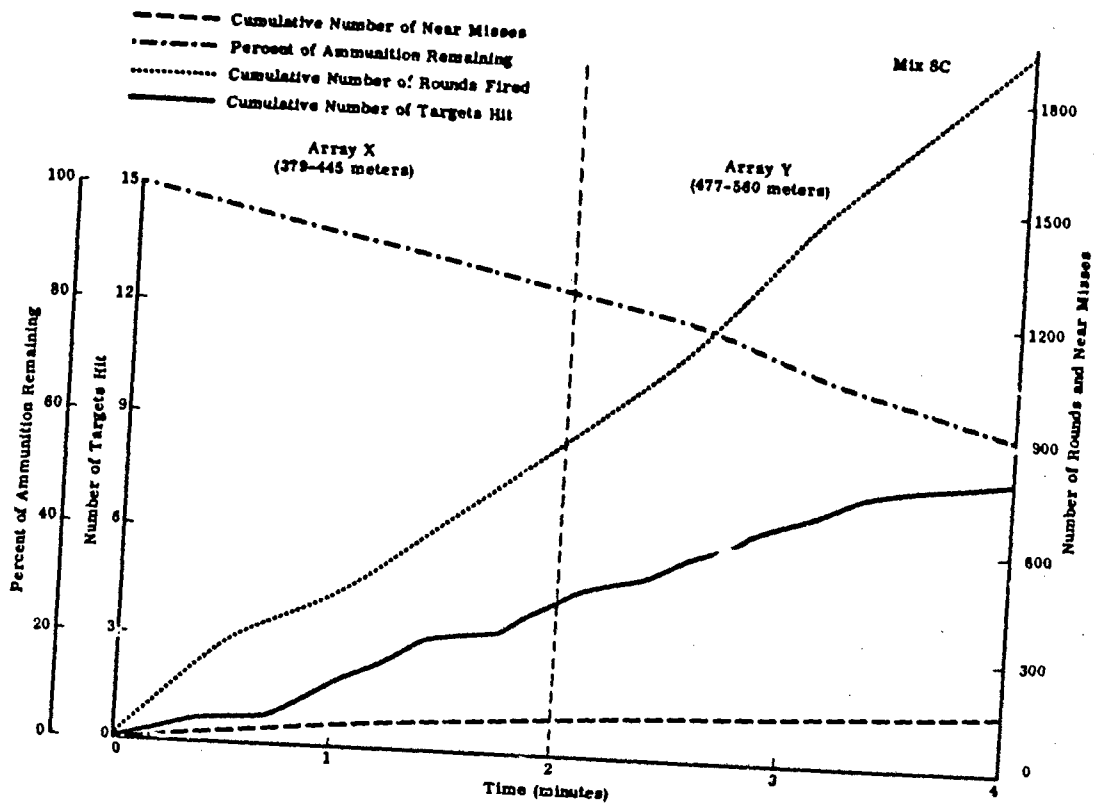

Figure 6-14 (Continued)  
 CUMULATIVE NUMBER OF ROUNDS FIRED, TARGETS HIT, NEAR MISSES,  
 AND PERCENT OF AMMUNITION REMAINING--SITUATION 5



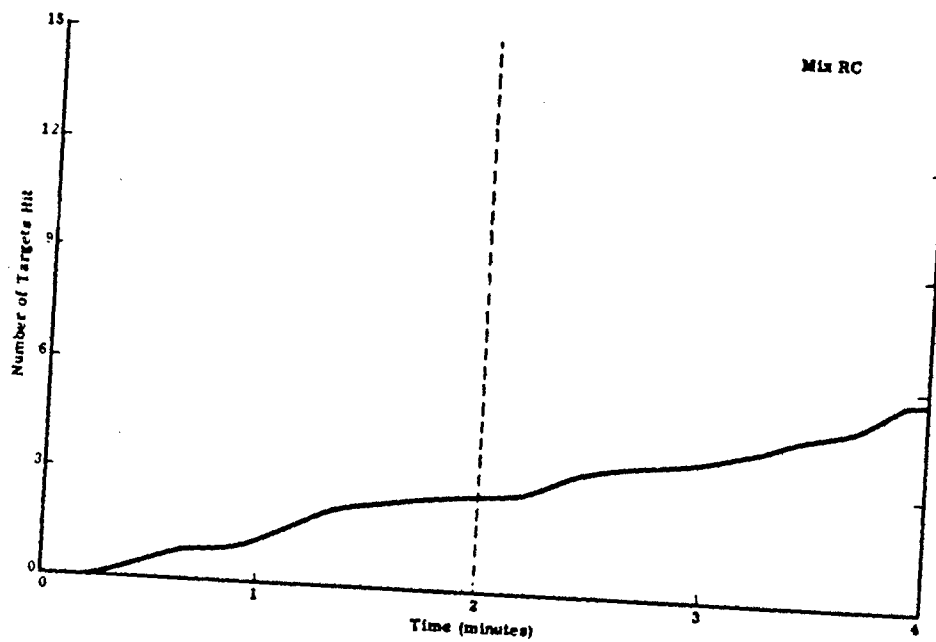
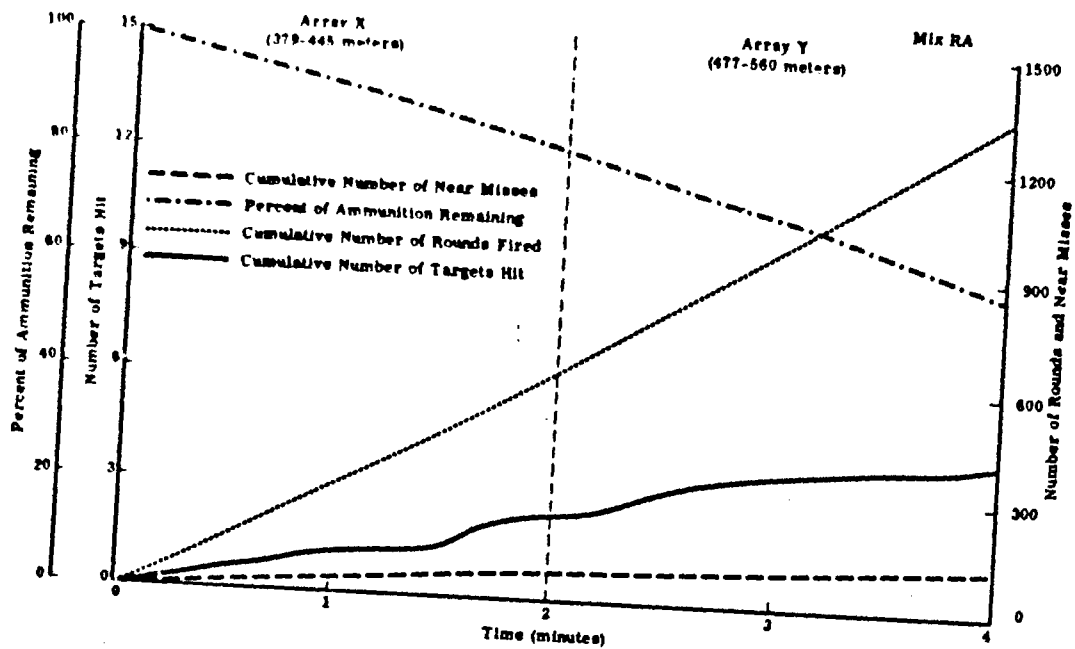

Figure 6-14 (Concluded)  
 CUMULATIVE NUMBER OF ROUNDS FIRED, TARGETS HIT, NEAR MISSES,  
 AND PERCENT OF AMMUNITION REMAINING--SITUATION 5

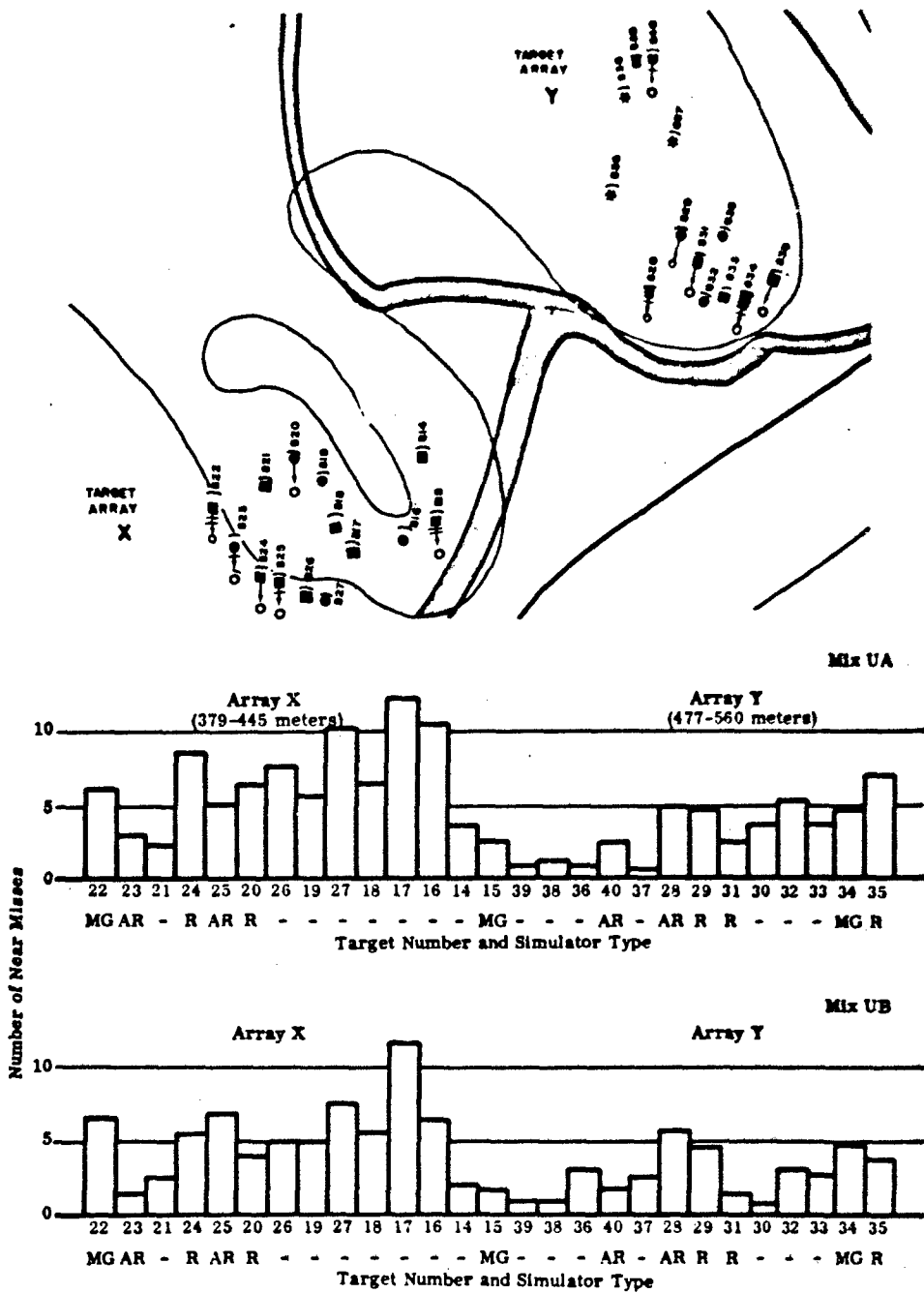

Figure 6-15 NUMBER AND DISTRIBUTION OF NEAR MISSES--SITUATION 5

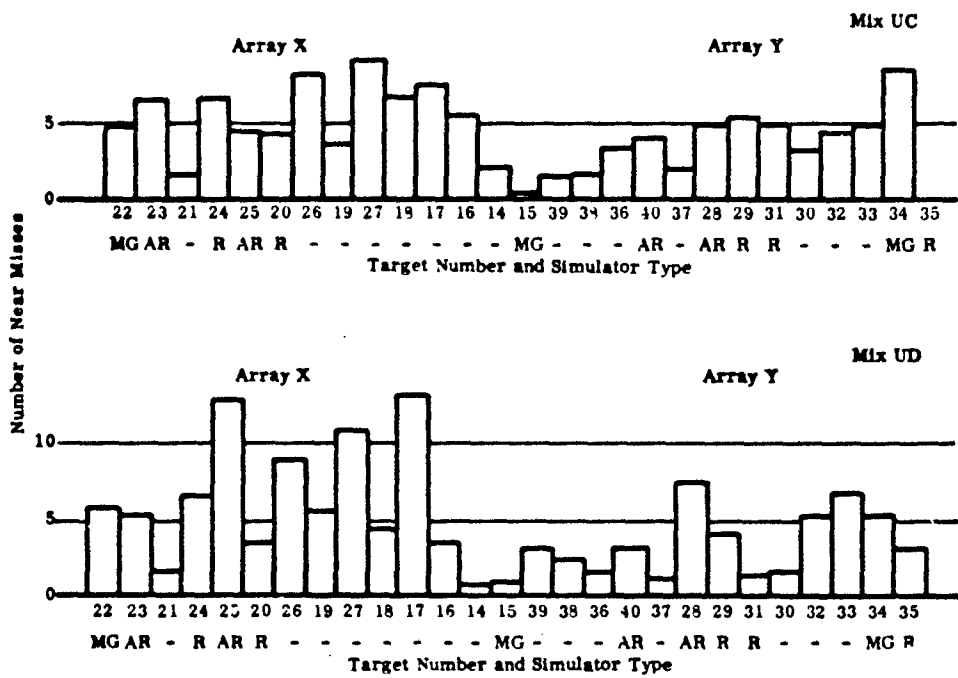
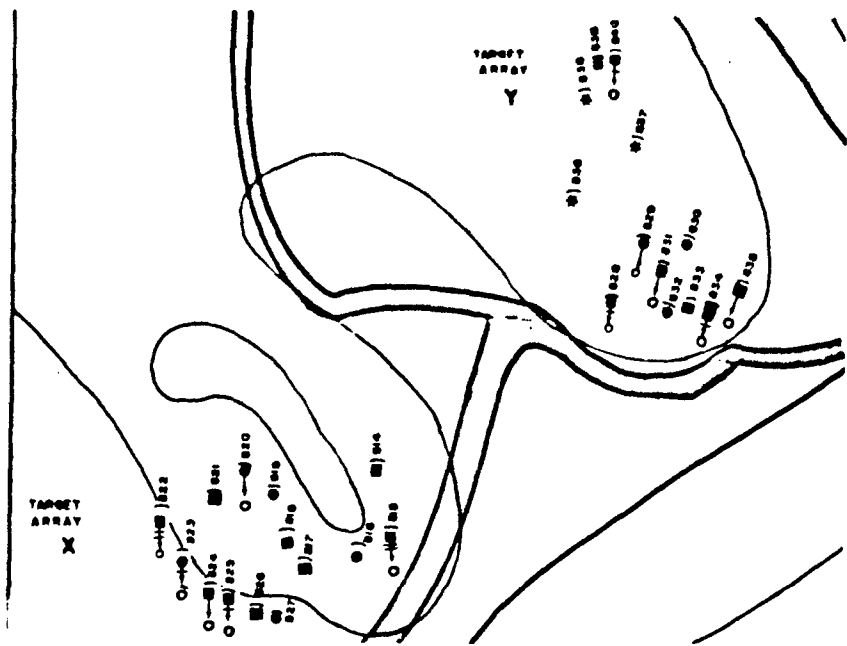

Figure 6-15 (Continued) NUMBER AND DISTRIBUTION OF NEAR MISSES--SITUATION 5

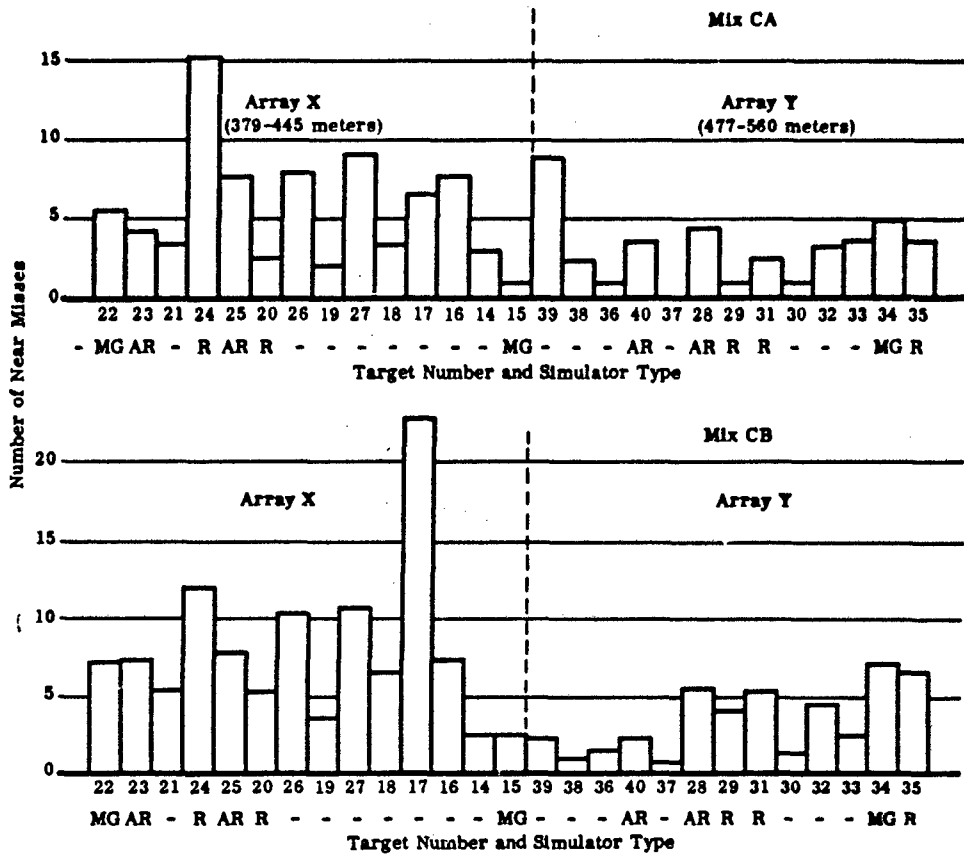

Figure 6-15 (Continued) NUMBER AND DISTRIBUTION OF NEAR MISSES--SITUATION 5

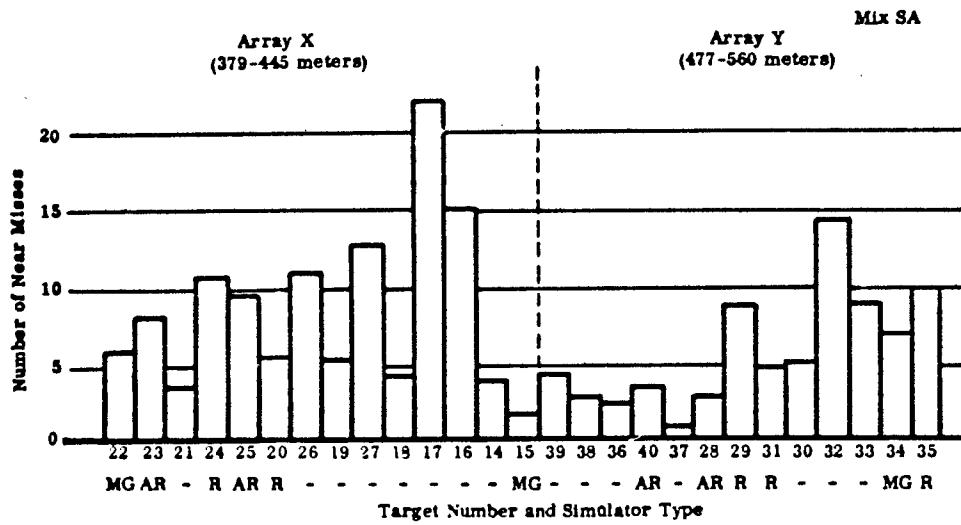

Figure 6-15 (Continued) NUMBER AND DISTRIBUTION OF NEAR MISSES--SITUATION 5

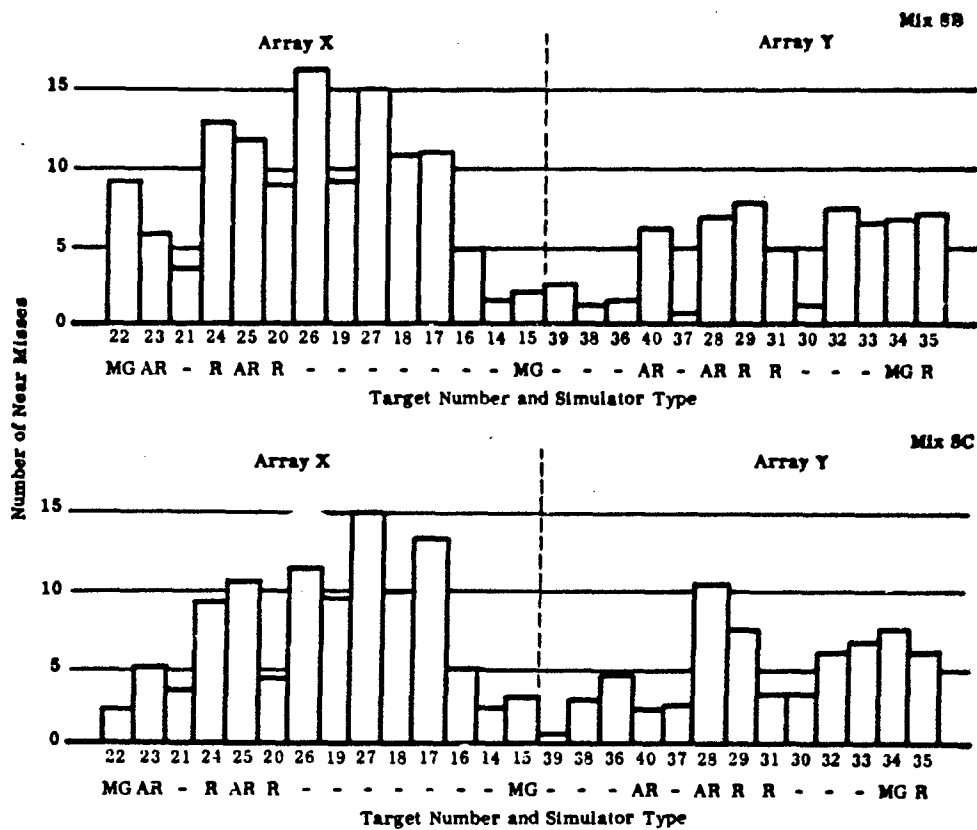

Figure 6-15 (Continued) NUMBER AND DISTRIBUTION OF NEAR MISSES--SITUATION 5

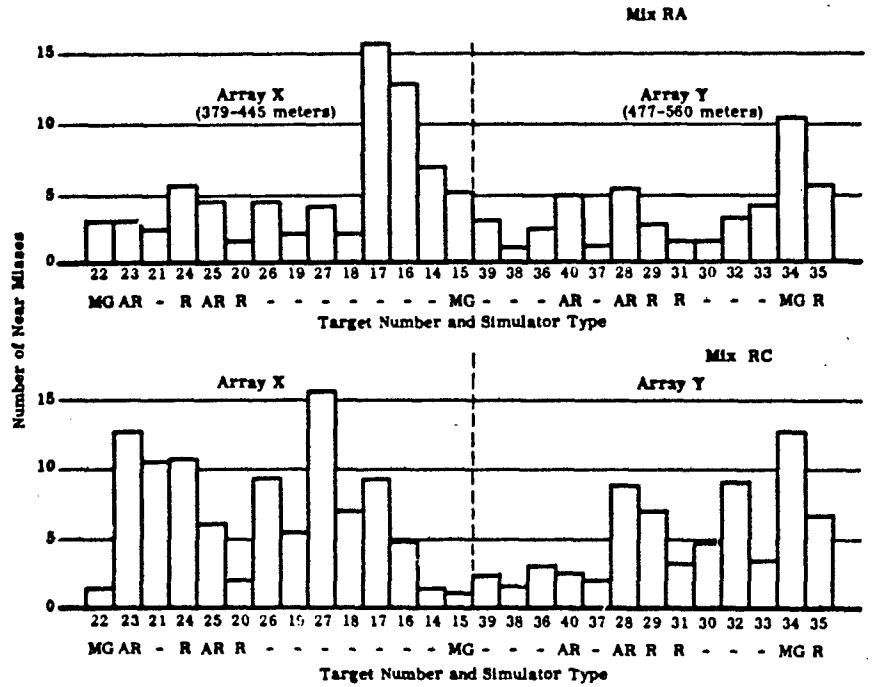
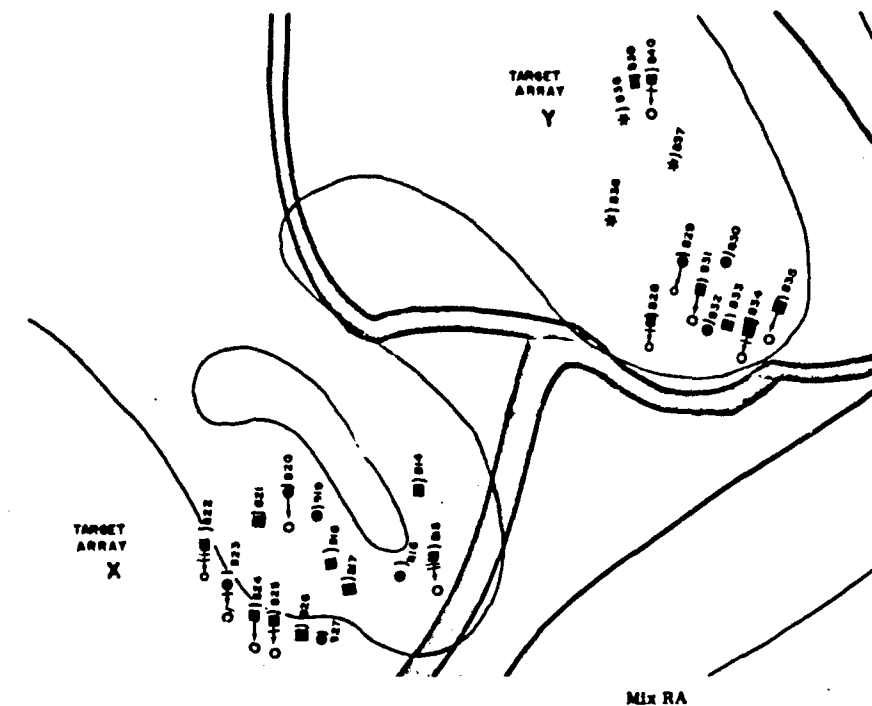

Figure 6-15 (Concluded) NUMBER AND DISTRIBUTION OF NEAR MISSES--SITUATION 5

5. Situation 7: Rifle Squad in Defense Against Attack

Rifle squad weapon mixes fired from hastily prepared foxholes at enemy targets appearing at ranges from 345 meters to 45 meters. Targets appeared in sequence, with long range targets appearing first. The attack ended with ten targets in an assault formation 45 meters from the firing positions. The duration of the situation was 8.19 minutes.

Two series of runs were made in this situation: Series 1, in which M14 rifles, were fired in the semiautomatic mode, while Stoner, Colt, M14E2, and AK47 weapons fired in the automatic mode; and Series 2, in which half of each mix fired automatic and the other half fired semiautomatic. Series 2 determined the best mode of fire (semiautomatic or automatic) for the various rifles and provided an index of the percentage increase or decrease in effectiveness furnished by automatic and semiautomatic fire in this situation (primarily aimed fire as a function of time at visible targets). Weapon mixes were then compared on the basis of their best mode of fire as determined by these Series 2 results. If Series 2 results showed a decrease in effectiveness resulting from a mode of fire different from that used in Series 1, the Series 1 score was left untouched. However, if Series 2 firings showed that a given percentage increase in effectiveness could be expected by using a mode of fire different from that used in Series 1, that mix's Series 1 score was increased (for comparative purposes) by an amount equivalent to the percent of increase indicated by Series 2 results. Results of Series 2 firings indicated that within the squad context in terms of both target effects and overall effectiveness (visible quick exposure targets from 45 to 345 meters), semiautomatic fire was superior to automatic fire for all rifles.

Results for the ten mixes (other than Mix RC) are presented in Figure 6-16. Figure 6-17 presents plots of cumulative exposure time (CET), targets hit, rounds fired, total hits, and percent of ammunition remaining as a function of range for the Colt, Stoner, AK47, and the all-M14E2 squad mixes in automatic fire, and for the other US 7.62mm mixes in semiautomatic fire. Although Figure 6-16 illustrates the expected performance of mixes in their best mode of fire, the plots in Figure 6-17 represent only firings in Series 1; therefore, Figure 6-17 is presented for purposes of illustration and does not necessarily represent performances with the weapons in their best mode of fire.

The rank order of weapon mixes (other than Mix RC) with associated standard scores are given below.



Target Effects Only			Overall Effectiveness*		
Rank	Mix	Standard Score	Rank	Mix	Standard Score
1	CB	86.4	1	CB	84.6
2	SC	65.3	2	SC	61.5
3	SB	63.8	3	SB	60.2
4	CA	59.5	4	CA	59.5
5	UA	55.7	5	SA	57.6
6	SA	48.0	6	UA	55.2
7	RA	37.4	7	RA	37.6
8	UB	33.1	8	UB	33.8
9	UC	31.8	9	UB	31.1
10	UD	19.1	10	UD	19.0

\* Sustainability weighted 1/3/ Target effects 2/3

Key:

- UA - 9 M14 Rifles
- UD - 9 M14E2 Rifles
- UB - 7 M14 Rifles and 2 M14E2 AR
- UC - 5 M14 Rifles and 2 M60 MG
- SA - 9 Stoner Rifles
- SB - 7 Stoner Rifles and 2 Stoner AR
- SC - 7 Stoner Rifles and 2 Stoner MG
- CA - 9 Colt Rifles
- CB - 7 Colt Rifles and 2 Colt AR
- RA - 9 AK47 Rifles

Mix RC results for Situation 7 are presented below.

CET	Near Misses	Percent Ammo Remaining	Targets Hit	Total Hits
6.74	--	61.44	46.60	72.00

EFFECTIVENESS MEASURES

COLLATERAL PERFORMANCE MEASURES

**A**

Mix	Cumulative Exposure Time		
	X (ET)	SD	Standard Score Z'
CB	4.1	0.9	86.1
SC	5.0	0.7	64.8
SB	5.0	1.4	63.8
CA	5.2	1.2	59.2
UA	5.4	0.4	55.4
SA	5.6	0.6	50.3
RA	6.1	0.9	37.2
UB	6.3	0.7	32.9
UC	6.3	0.7	31.7
UD	6.8	1.5	18.7
$\bar{X}$	5.57		
$\sigma$	.79		

**B**

Mix	Number of Near Misses		
	X	SD	Standard Score Z'
CB			
SC			
SB			
CA			
UA			
SA			
RA			
UB			
UC			
UD			
$\bar{X}$			
$\sigma$			

**C**

Mix	Sustainability (% Ammo Remaining)			
	X	SD	Standard Score Z'	Sustainability Time (Min)
CB	94.8	1.0	80.9	158.1
SA	91.4	2.2	76.8	95.6
CA	77.1	5.8	59.6	35.9
UA	72.5	6.7	54.0	29.9
SC	72.4	8.2	53.9	29.8
SB	71.7	7.4	53.1	29.1
UC	55.1	17.5	37.9	20.1
RA	59.1	5.2	37.9	20.1
UB	50.1	12.9	27.1	16.5
UD	43.1	7.5	18.7	14.5
$\bar{X}$	69.12			
$\sigma$	16.64			

**D**

Mix	Number of Targets Hit		
	X	SD	Standard Score Z'
SB	56.0	0.0	77.4
SC	56.0	0.0	77.4
CB	34.4	4.1	69.5
CA	32.8	4.0	61.2
UA	50.2	3.7	49.4
SA	48.5	3.4	37.6
UB	48.1	3.7	37.8
UC	47.5	1.6	34.6
SA	47.0	1.8	32.4
UD	44.9	4.1	21.8
$\bar{X}$	50.54		
$\sigma$	4.00		

**E**

Mix	Total Hits on Targets		
	X	SD	Standard Score Z'
CB	90.5	17.0	84.0
CA	84.5	11.5	69.1
SB	82.5	23.0	64.3
SC	82.2	10.1	63.4
RA	76.7	11.5	49.9
UC	74.2	12.2	13.8
UB	73.4	8.4	41.8
UD	70.2	5.8	33.8
UA	69.2	8.7	31.4
SA	64.1	8.1	18.7
$\bar{X}$	76.74		
$\sigma$	8.10		

**F**

Mix	Target Effects	
	Standard Score	Target Effects
CB	86.1	
SC	64.8	
SB	63.8	
CA	59.2	
UA	55.4	
SA	50.3	
RA	37.2	
UB	32.9	
UC	31.7	
UD	18.7	

**G**

Mix	Overall Effectiveness	
	Standard Score	Overall Fire Effectiveness
CB	84.4	
SC	61.2	
SB	60.2	
CA	59.3	
UA	59.1	
SA	54.9	
RA	37.4	
UC	33.8	
UB	31.0	
UD	18.7	

**H**

	CB	SC	SB	CA	UA	SA	RA	UB	UC	UD
CB		.05	.11	.06	.006	.004	.004	.000	.000	.003
SC			>.40	.35	.15	.08	.02	.006	.005	.02
SB				>.40	.30	.21	.09	.04	.04	.03
CA					>.40	.27	.11	.05	.04	.04
UA						.25	.05	.01	.01	.02
SA							.13	.04	.03	.05
RA								.36	.33	.19
UB									>.40	.22
UC										.24

**I**

	CB	SC	SB	CA	UA	SA	RA	UB	UC	UD
CB										
SC										
SB										
CA										
UA										
SA										
RA										
UB										
UC										
UD										

**J**

	CB	SA	CA	UA	SC	SB	UC	RA	UB	UD
CB		.004	.000	.000	.000	.000	.000	.001	.000	.000
SA			.001	.000	.001	.001	.000	.001	.000	.000
CA				.12	.14	.10	.008	.001	.000	.000
UA					>.40	>.40	.03	.004	.003	.000
SC						>.40	.03	.008	.004	.000
SB							.04	.006	.004	.000
UC								>.40	.13	.02
RA									.09	.003
UB										.14
UD										

**K**

	SB	SC	CB	RA	CA	UA	UB	UC	SA	UD
SB		*	*	*	*	*	*	*	*	*
SC			*	*	*	*	*	*	*	*
CB				.26	.05	.01	.01	.006	.002	.002
RA					.15	.04	.04	.02	.006	.006
CA						.21	.17	.11	.04	.02
UA							>.40	.32	.19	.07
UB								.38	.27	.09
UC									>.40	.14
SA										.14
UD										

**L**

	CB	CA	SB	SC	RA	UC	UB	UD	UA	SA
CB		.24	.26	.16	.08	.04	.13	.91	.01	.004
CA			>.40	.36	.15	.09	.05	.02	.02	.004
SB				>.40	.31	.23	.19	.12	.11	.05
SC					.21	.13	.07	.02	.03	.004
RA						.37	.30	.13	.13	.03
UC							>.40	.24	.22	.06
UB								.23	.21	.04
UD									>.40	.08
UA										.16
SA										

Note: Standard Scores computed from raw scores using scores to three decimal places.

UA - 9 M14 Rifles  
 UB - 7 M14 Rifles/2 M14E2 AR  
 UC - 5 M14 Rifles/2 M60 MG  
 UD - 9 M14E2 Rifles  
 CA - 9 Colt Rifles

CB - 7 Colt Rifles/2 Colt AR  
 SA - 9 Stoner Rifles  
 SB - 7 Stoner Rifles/2 Stoner AR  
 SC - 7 Stoner Rifles/2 Stoner MG  
 RA - 9 AK47 Rifles

$\bar{X}$  - Mean (Average)  
 SD - Standard Deviation  
 CET - Cumulative Exposure Time  
 z' - Standard Score (X = 50, SD = 20)

Variance and standard deviation if mixes SC and SB is zero and no distribution exists therefore probability values cannot be computed.

**C**

Statistical Data  
(Cumulative Exposure Times)

Unit	Mix	Mean	SD	Standard Score	Time (Min)
CB	96.8	1.0	80.8	154.1	
CA	91.4	2.2	78.8	95.8	
CB	77.1	5.4	59.6	35.9	
SA	72.5	6.7	54.0	29.9	
SC	72.4	8.2	53.9	29.8	
SB	74.7	7.4	53.1	29.1	
UC	59.1	14.5	37.9	20.1	
RA	59.1	5.2	37.9	20.1	
UB	50.1	12.9	27.1	18.5	
UD	43.1	7.5	19.7	14.5	
$\bar{x}$	69.12				
$\sigma$	16.64				

**UNILATERAL PERFORMANCE MEASURES**

**D** Number of Targets Hit

Mix	% Targets Hit	Standard Score	
CB	58.0	0.9	77.4
CA	56.0	0.0	77.4
CB	54.4	4.1	69.5
RA	52.8	4.8	61.3
CA	50.2	3.7	48.4
UA	48.5	3.4	37.6
UB	48.1	3.7	37.8
UC	47.5	3.6	34.6
SA	47.0	1.8	32.4
UD	44.9	4.1	21.8
$\bar{x}$	50.54		
$\sigma$	4.00		

**E** Total Hits on Targets

Mix	% Hits	SD	Standard Score
CB	90.5	17.0	84.0
CA	84.5	11.5	69.1
SB	82.5	23.0	64.3
SC	82.2	10.1	63.4
RA	78.7	11.5	49.9
UC	74.2	12.2	43.9
UB	73.4	8.4	41.8
UD	70.2	5.8	33.8
UA	69.2	8.7	31.4
SA	64.1	9.1	18.7
$\bar{x}$	76.74		
$\sigma$	8.10		

**B** Cumulative Exposure Time

Unit	SC	SB	CA	UA	SA	RA	UB	UC	UD
CB	.05	.11	.06	.006	.004	.004	.000	.000	.003
CA	>.40	.35	.15	.08	.02	.006	.003	.02	
CB	>.40	.30	.21	.09	.04	.04	.03		
CA	.40	.27	.11	.05	.04	.04			
SA		.25	.05	.01	.01	.02			
RA			.13	.04	.05	.05			
UB				.36	.33	.19			
UC					.40	.22			
UD									.24

**I** Number of Near Misses

Unit	SC	SB	CA	UA	SA	RA	UB	UC	UD
CB									
CA									
SB									
SC									
RA									
UB									
UC									
UD									
UA									

**J** No. of Targets Hit

Unit	SC	CB	RA	CA	UA	UB	UC	SA	UD
CB	*	*	*	*	*	*	*	*	*
CA		*	*	*	*	*	*	*	*
SB			.26	.05	.01	.01	.006	.002	.002
SC			.15	.04	.04	.02	.006	.006	
RA				.21	.17	.11	.04	.02	
UC					.40	.32	.19	.07	
UB						.34	.27	.09	
UD							.40	.14	
UA									.14

**L** Total Hits on Targets

Unit	CB	CA	SB	SC	RA	UC	UB	UD	UA	SA
CB	.24	.26	.16	.08	.04	.13	.01	.01	.004	
CA		>.40	.36	.15	.09	.05	.02	.02	.004	
SB			>.40	.31	.23	.19	.12	.11	.05	
SC				>.40	.21	.13	.07	.02	.02	.004
RA					>.40	.37	.30	.13	.13	.03
UC						>.40	.24	.22	.06	
UB							>.40	.23	.21	.04
UD								>.40	.14	
UA									>.40	.16

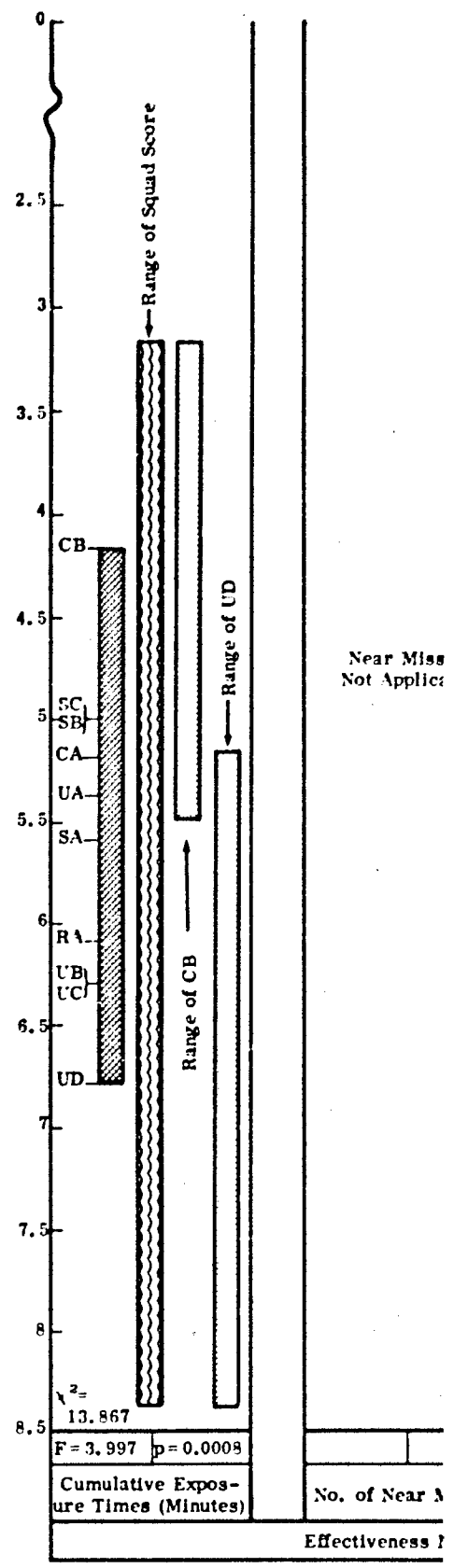

\*14 Rifles  
 \*14 Rifles/2 M14E2 AR  
 \*14 Rifles/2 M60 MG  
 \*14E2 Rifles  
 \*olt Rifles

CB - 7 Colt Rifles/2 Colt AR  
 SA - 9 Stoner Rifles  
 SB - 7 Stoner Rifles/2 Stoner AR  
 SC - 7 Stoner Rifles/2 Stoner MG  
 RA - 9 AK47 Rifles

$\bar{x}$  - Mean (Average)  
 SD - Standard Deviation  
 CET - Cumulative Exposure Time  
 $\sigma^2$  - Standard Score ( $\bar{x} = 50, SD = 20$ )

Figure 6-

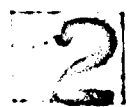

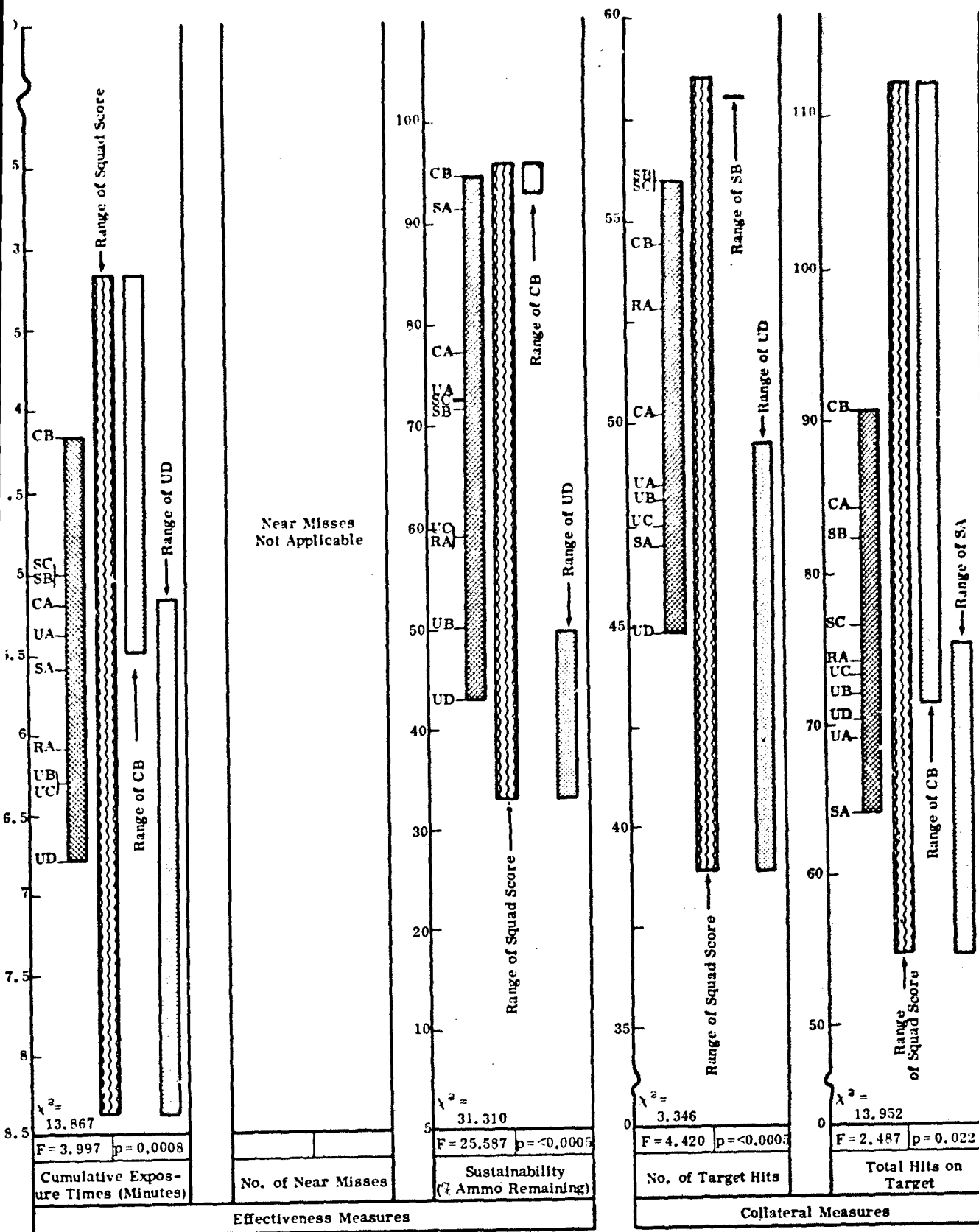

Figure 6-16 SUMMARY OF RESULTS--SITUATION 7

**BLANK PAGE**

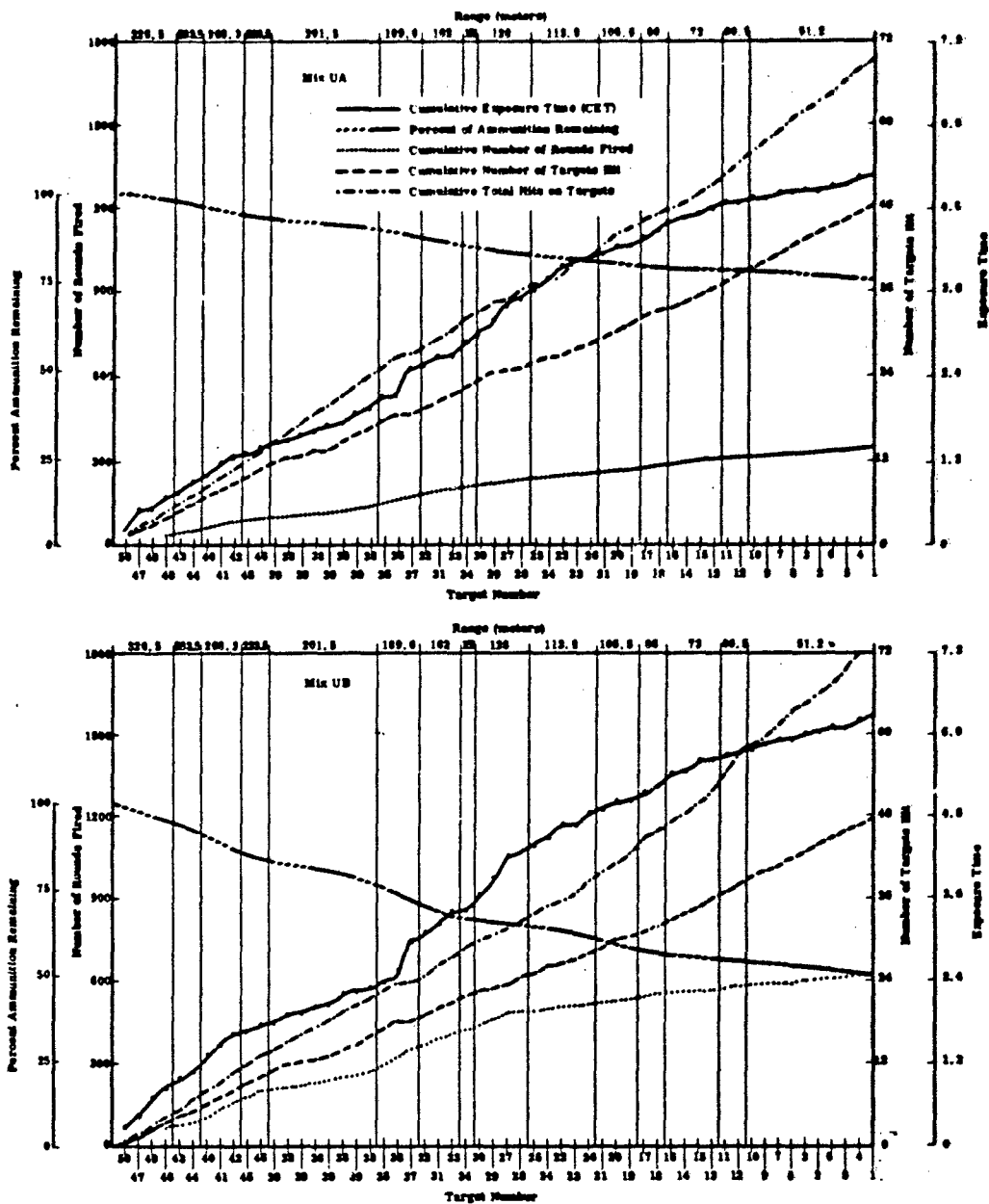

Figure 6-17

CUMULATIVE EXPOSURE TIME, TARGETS HIT, ROUNDS FIRED, TOTAL HITS, AND PERCENT OF AMMUNITION REMAINING--SITUATION 7

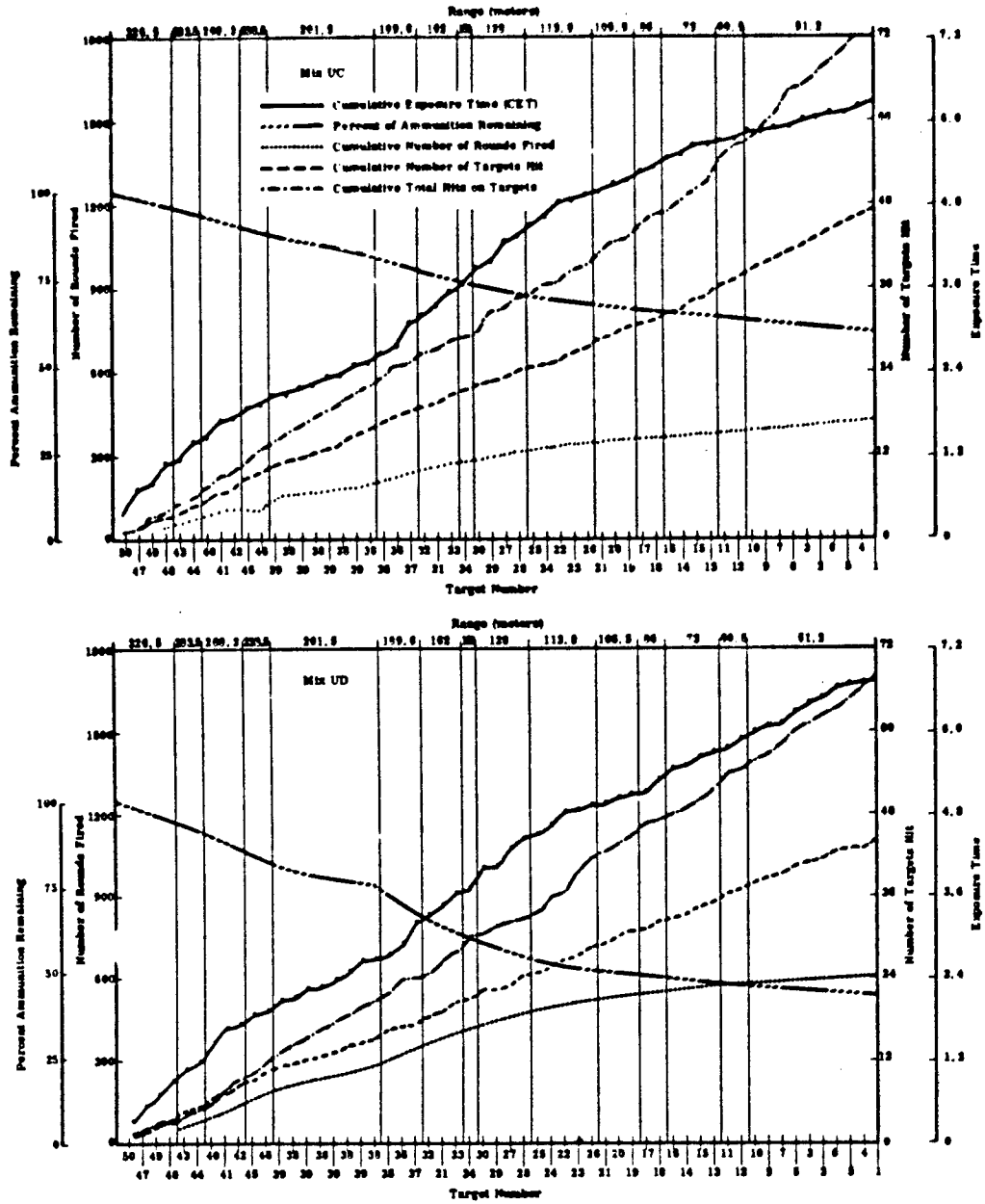

Figure 6-17 (Continued)  
 CUMULATIVE EXPOSURE TIME, TARGETS HIT, ROUNDS FIRED, TOTAL HITS, AND PERCENT OF AMMUNITION REMAINING--SITUATION 7

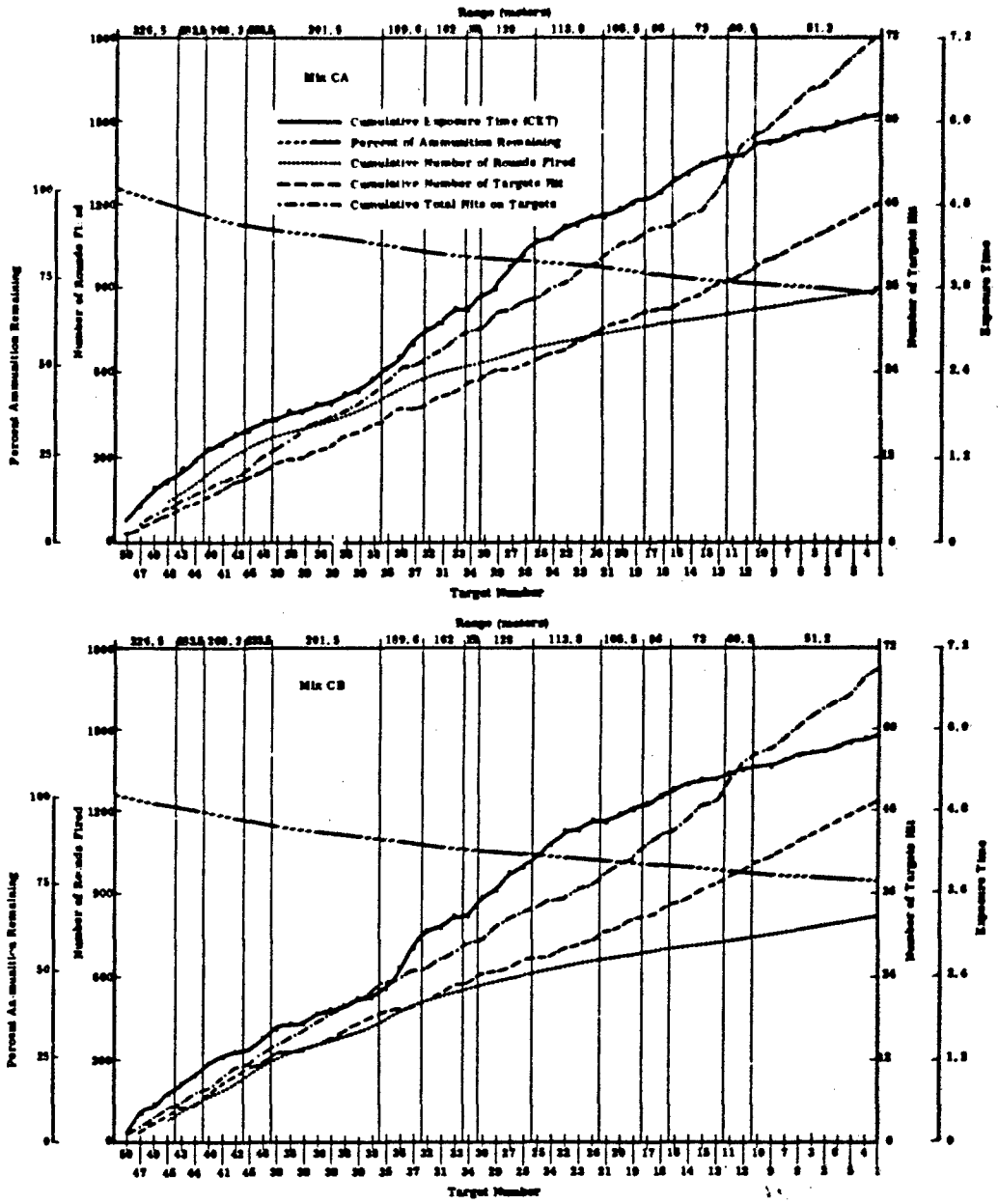

Figure 6-17 (Continued)

CUMULATIVE EXPOSURE TIME, TARGETS HIT, ROUNDS FIRED, TOTAL HITS, AND PERCENT OF AMMUNITION REMAINING--SITUATION 7



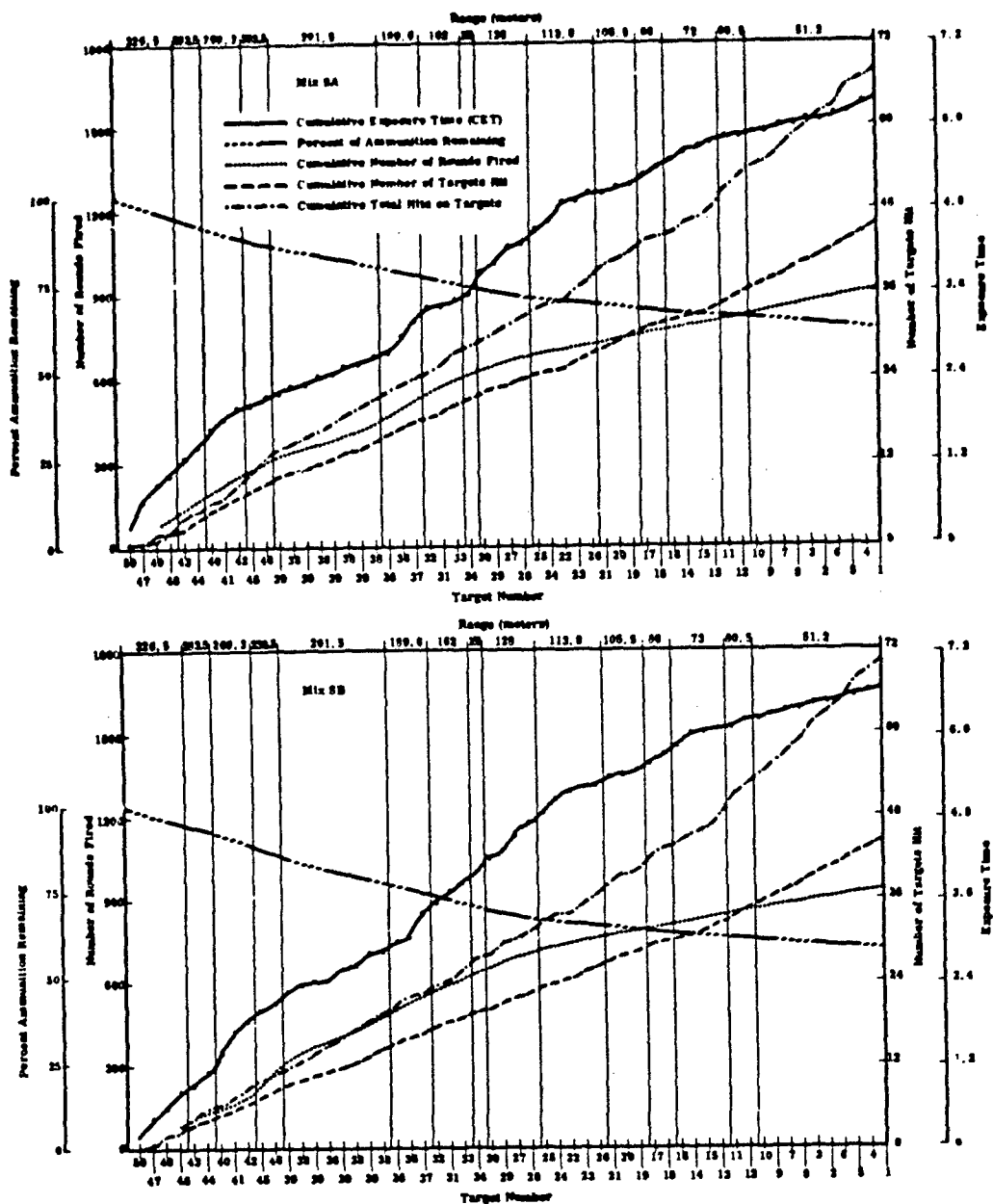

Figure 6-17 (Continued)

CUMULATIVE EXPOSURE TIME, TARGETS HIT, ROUNDS FIRED, TOTAL HITS, AND PERCENT OF AMMUNITION REMAINING--SITUATION 7

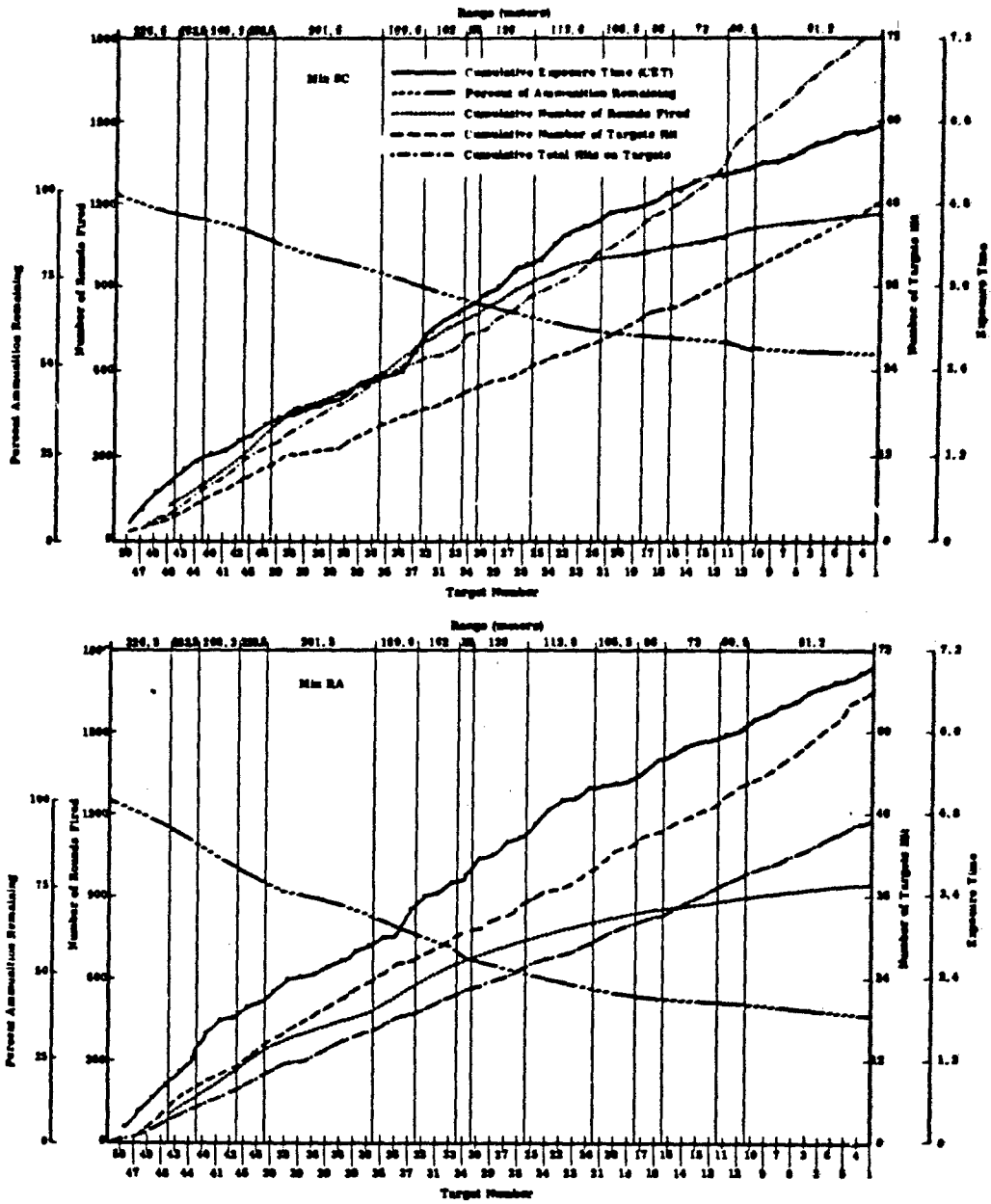

Figure 6-17 (Concluded)

CUMULATIVE EXPOSURE TIME, TARGETS HIT, ROUNDS FIRED, TOTAL HITS, AND PERCENT OF AMMUNITION REMAINING--SITUATION 7

6. Situation 8: Rifle Squad in Night Defense Against Attack

Rifle squad weapon mixes fired from hastily prepared foxholes at enemy targets raised for fixed exposure times in sequence beginning at a range of 235 meters from the firers and ending with a ten-man final assault at 45 meters. The cycle was then repeated with targets coming up in a different sequence the second cycle. This represented a regrouping for a second attack and provided a broader data base. In this situation the enemy targets were not visible to the firers because of darkness, and cues were simulator flash and sound. The duration of the situation was 4.8 minutes for both cycles combined.

As in Situation 7, a second series (not to be confused with the second cycle discussed above) was fired to determine the better mode of fire (semiautomatic or automatic) for the different rifles. Because of the variability of scores, however, it was not possible to conclude that one mode was better than the other for any weapon in this night situation. For example, although the M14 rifles that were fired at night in the automatic mode increased their target effects approximately 17.4 percent, they were still not superior to the low impulse weapons and expended 26.4 percent more ammunition to achieve the gain. It was therefore judged that the proper mode of fire for the M14 at night under circumstances similar to those of Situation 8 is semiautomatic. In like manner, there was no reason for concluding that the other rifles had not fired in their best mode in Series 1; therefore, Series 2 scores were not integrated with Series 1 scores.

Results for the ten mixes (other than Mix RC) are presented in Figure 6-18. Figure 6-19 illustrates CET as a function of target range for Cycles 1 and 2. On each cycle the range is decreasing as the attack progresses toward the weapon positions.

Results for the ten mixes (other than Mix RC) are presented in the following tables and graphs. The rank order of ten mixes with associated standard scores is presented below.

Target Effects Only			Overall Effectiveness*		
Rank	Mix	Standard Score	Rank	Mix	Standard Score
1	SB	74.6	1	CB	70.9
2	SC	71.9	2	SB	69.5
3	CB	66.9	3	SC	65.2
4	SA	65.8	4	SA	64.1
5	CA	48.9	5	CA	58.4
6	UB	46.2	6	UC	45.6
7	UC	43.5	7	UB	43.1
8	UA	43.5	8	UA	42.5
9	RA	23.5	9	RA	21.5
10	UD	15.4	10	UD	19.5

\* Sustainability weighted 1/3; Target effects 2/3

Key:

UA - 9 M14 Rifles	SB - 7 Stoner Rifles and 2 Stoner AR
UD - 9 M14E2 Rifles	SC - 7 Stoner Rifles and 2 Stoner MG
UB - 7 M14 Rifles and 2 M14E2 AR	CA - 9 Colt Rifles
UC - 5 M14 Rifles and 2 M60 MG	CB - 7 Colt Rifles and 2 Colt AR
SA - 9 Stoner Rifles	RA - 9 AK47 Rifles
RC - 7 AK47 Rifles and 2 RPD MG	

Mix RC results for Situation 8 are presented below.

CET	Near Misses	Percent Ammo Remaining	Targets Hit	Total Hits
6.73	--	20.00	19.40	28.80

#17675

**A Cumulative Exposure Times**

Mix	$\bar{X}$ CET	SD	Standard Score $z^*$
SB	6.03	.4	74.6
SC	6.10	.6	71.9
CB	6.23	.4	66.9
SA	6.26	.2	65.8
CA	6.70	.5	48.9
UB	6.77	.4	46.2
UC	6.84	.6	43.5
UA	6.84	.3	43.5
RA	7.36	.6	23.5
UD	7.57	.5	15.4
$\bar{X}$	6.67		
SD	.52		

**B Number of Near Misses**

Mix	$\bar{X}$ Near Misses	SD	Standard Score $z^*$
SB			
SC			
CB			
SA			
CA			
UB			
UC			
UA			
RA			
UD			
$\bar{X}$			
SD			

**C Sustainability (Ammo Remaining)**

Mix	$\bar{X}$ % Remaining	SD	Standard Score $z^*$	Sustainability Time (Min)
CB	69.4	4.2	74.8	13.6
CA	68.6	4.9	77.4	15.2
SA	58.3	2.4	60.6	11.4
SB	57.4	9.5	59.2	11.2
SC	52.9	3.9	51.8	10.1
UC	51.6	10.5	49.7	9.9
UA	46.0	4.6	40.5	8.8
UB	43.7	3.4	36.8	8.5
UD	38.1	3.1	27.6	7.7
RA	21.9	6.5	17.5	7.0
$\bar{X}$	51.8			
SD	12.25			

**D Number of Targets Hit**

Mix	$\bar{X}$ Targets Hit	SD	Standard Score $z^*$
CB	25.5	4.3	76.0
SB	24.7	5.3	71.4
SA	23.8	3.6	66.3
SC	23.6	5.0	65.2
UB	27.3	3.0	52.1
CA	20.7	3.2	48.6
UA	19.8	2.9	43.5
UC	18.3	3.9	35.0
RA	16.4	5.0	24.1
UD	15.3	5.0	17.9
$\bar{X}$	20.94		
SD	3.51		

**E Total Hits on Targets**

Mix	$\bar{X}$ Hits	SD	Standard Score $z^*$
SC	38.0	1.0	
CB	37.8	1.0	
SB	35.7	1.0	
SA	35.4	1.0	
CA	31.3	1.0	
UB	28.3	1.0	
UA	22.8	1.0	
UC	22.2	1.0	
RA	19.6	1.0	
UD	19.2	1.0	
$\bar{X}$	29.03		
SD	7.59		

**F Target Effects**

Mix	Standard Score Target Effects
SB	74.6
SC	71.9
CB	66.9
SA	65.8
CA	48.9
UB	46.2
UC	43.5
UA	43.5
RA	23.5
UD	15.4

**G Overall Effectiveness**

Mix	Overall Fire Effectiveness
CB	70.9
SB	69.5
SC	65.2
SA	64.1
CA	58.4
UC	45.6
UB	43.1
UA	42.5
RA	21.5
UD	19.5

**H Cumulative Exposure Time**

	SB	SC	CB	SA	CA	UB	UC	UA	RA	UD
SB		>.40	.29	.27	.05	.03	.03	.02	.007	.002
SC			.33	.28	.04	.02	.03	.01	.005	.001
CB				>.40	.05	.02	.03	.01	.003	.001
SA					.05	.02	.03	.005	.004	.001
CA						.39	.32	.28	.04	.008
UB							>.40	.38	.04	.01
UC								>.40	.09	.02
UA									.05	.01
RA										.28

**I Number of Near Misses**

	SB	SC	CB	SA	CA	UB	UC	UA	RA	UD
SB										
SC										
CB										
SA										
CA										
UB										
UC										
UA										
RA										

**J Sustainability (Ammo Remaining)**

	CB	CA	SA	SB	SC	UC	UA	UB	UD	RA
CB		.37	.001	.01	.001	.003	.001	.001	.001	.001
CA			.002	.02	.001	.004	.001	.001	.001	.001
SA				>.40	.02	.10	.001	.001	.001	.001
SB					.17	.17	.02	.004	.001	.001
SC						>.40	.02	.002	.001	.001
UC							.13	.06	.008	.004
UA								.18	.004	.002
UB									.009	.003
UD										.03

**K No. of Targets Hit**

	CB	SB	SA	SC	UB	CA	UA	UC	RA	UD
CB		.39	.25	.26	.04	.03	.02	.009	.005	.003
SB			.38	.37	.11	.08	.04	.02	.02	.006
SA				>.40	.13	.08	.04	.03	.02	.008
SC					.19	.14	.08	.04	.03	.02
UB						.36	.20	.09	.04	.02
CA							.32	.14	.06	.03
UA								.24	.10	.04
UC									.25	.14
RA										.37

**L Total Hits on Targets**

	SC	CB	SB	SA	CA	UB	UA	UC
SC		>.40	.51	.34	.14	.04	.005	.008
CB			.37	.35	.15	.02	.001	.001
SB				.38	.35	.05	.004	.005
SA					.19	.02	.001	.003
CA						.20	.02	.02
UB							.003	.01
UA								.38
UC								

Note: Standard Scores computed from raw scores using scores to three decimal places.

UA - 9 M14 Rifles  
 UB - 7 M14 Rifles/2 M14E2 AR  
 UC - 5 M14 Rifles/2 M60 MG  
 UD - 9 M14E2 Rifles  
 CA - 9 Colt Rifles

CB - 7 Colt Rifles/2 Colt AR  
 SA - 9 Stoner Rifles  
 SB - 7 Stoner Rifles/2 Stoner AR  
 SC - 7 Stoner Rifles/2 Stoner MG  
 RA - 9 AK47 Rifles

$\bar{X}$  - Mean (Average)  
 SD - Standard Deviation  
 CET - Cumulative Exposure T  
 $z^*$  - Standard Score ( $X = 50$ )



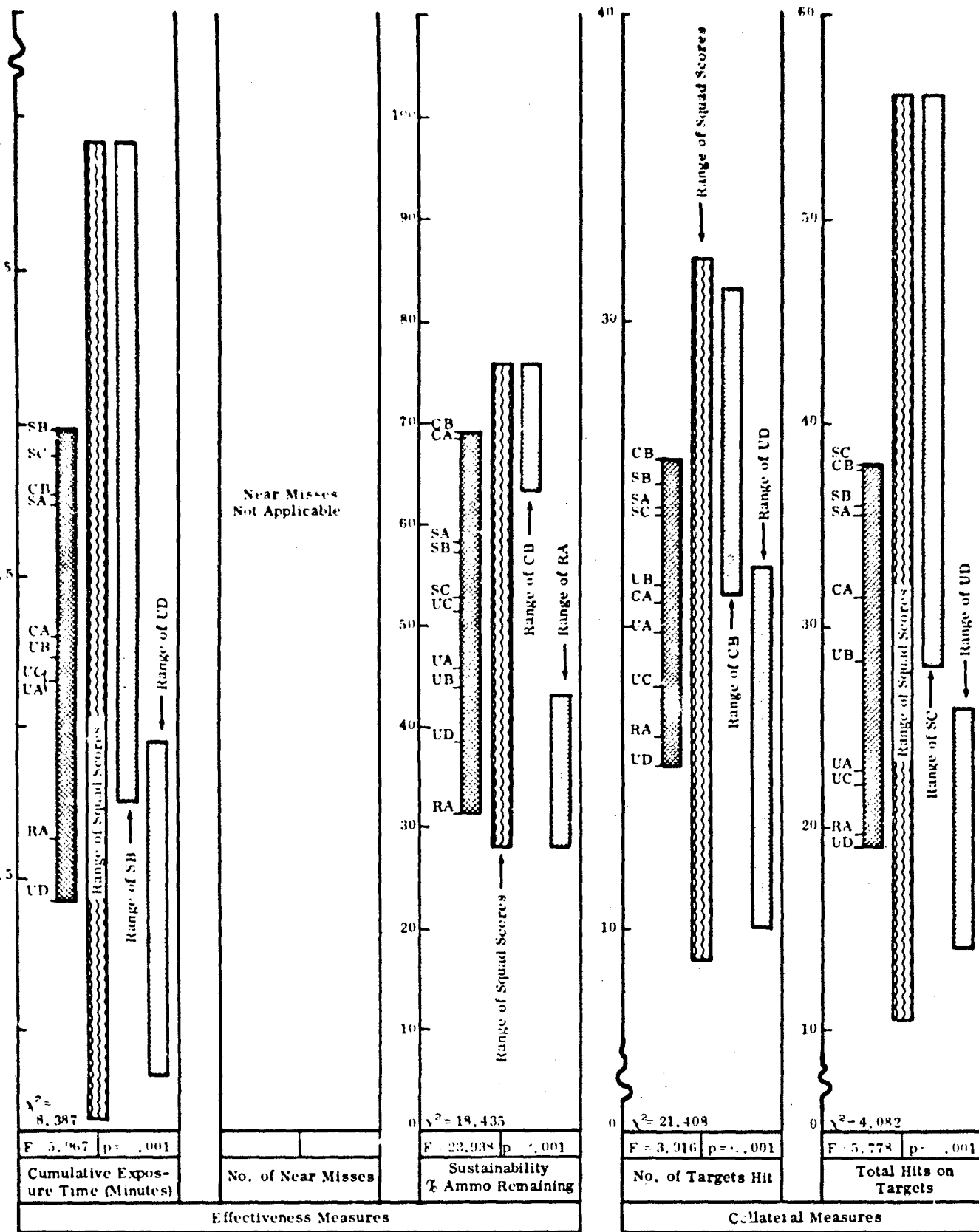

Figure 6-18 SUMMARY OF RESULTS--SITUATION 8

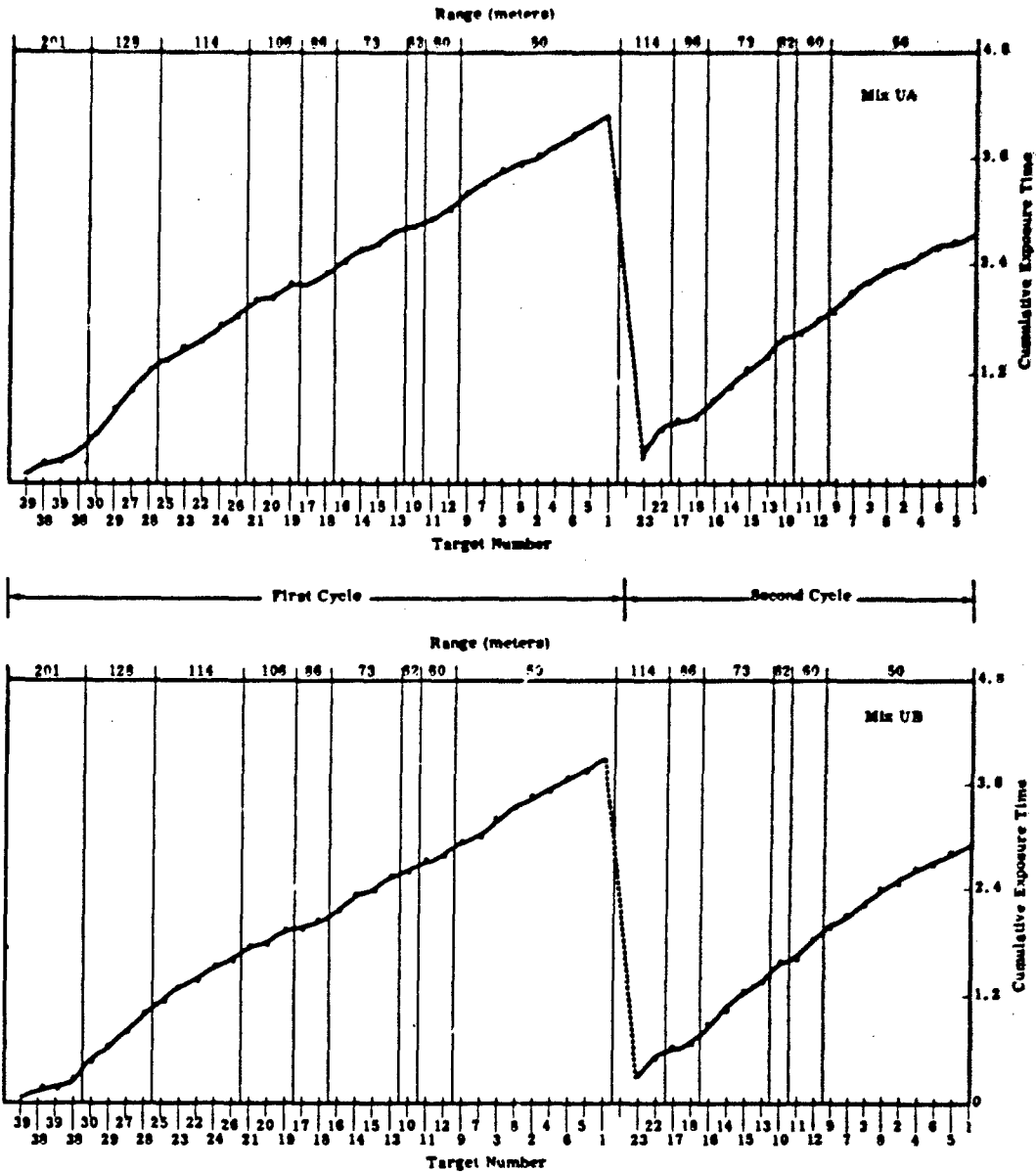

Figure 6-19  
CUMULATIVE EXPOSURE TIME--SITUATION 8



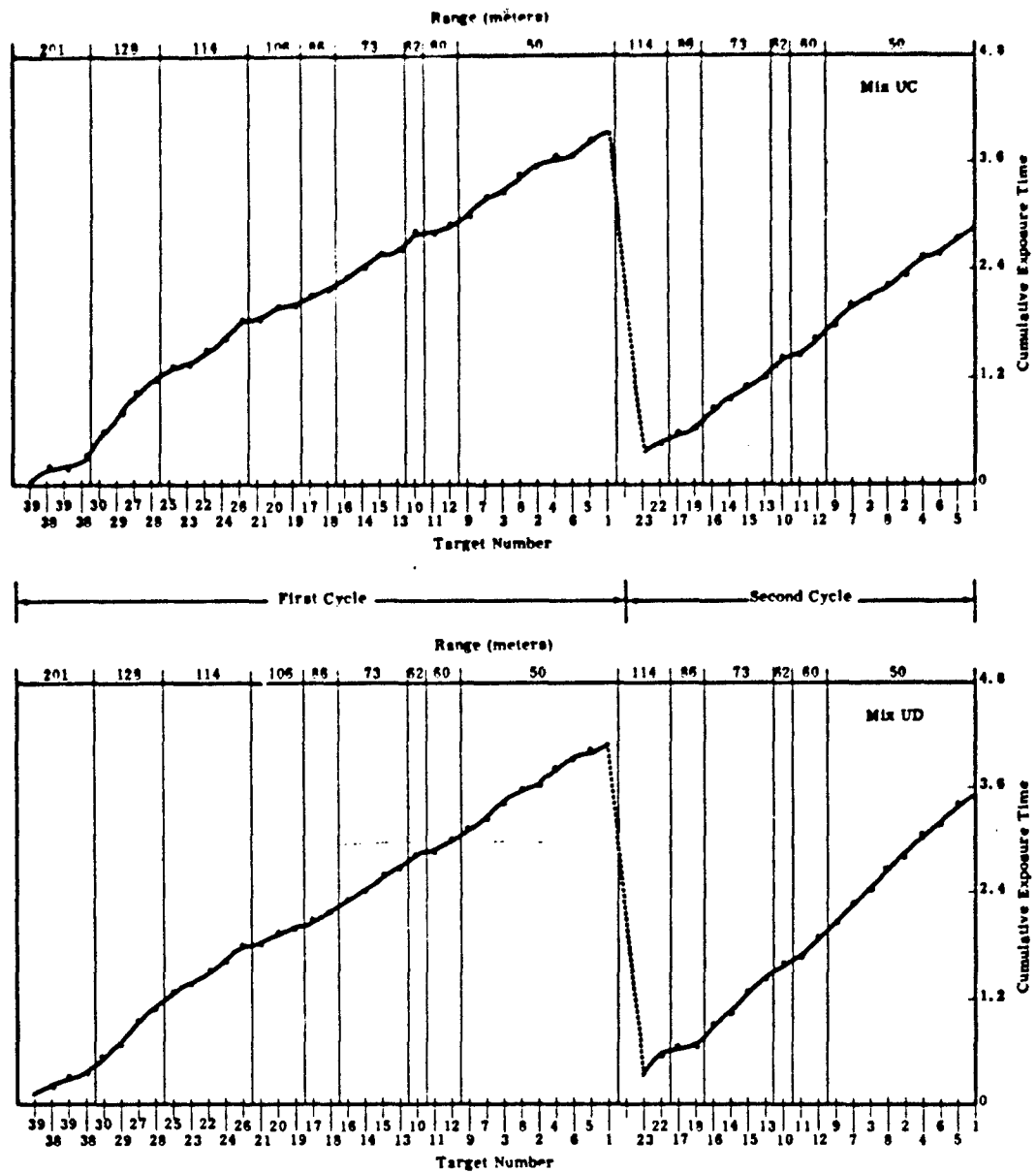

Figure 6-19 (Continued)  
CUMULATIVE EXPOSURE TIME--SITUATION 8

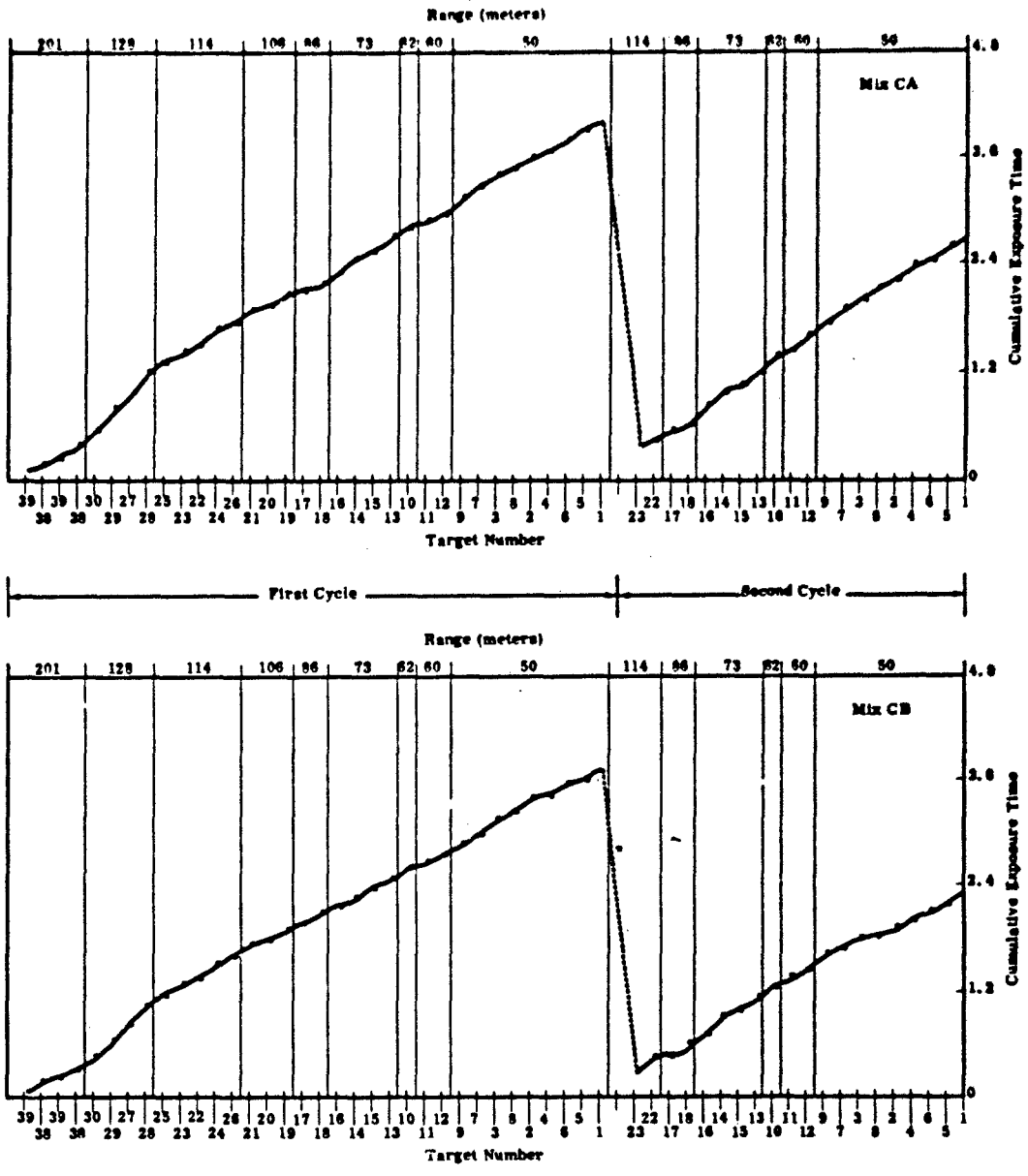

Figure 6-19 (Continued)  
CUMULATIVE EXPOSURE TIME--SITUATION 8

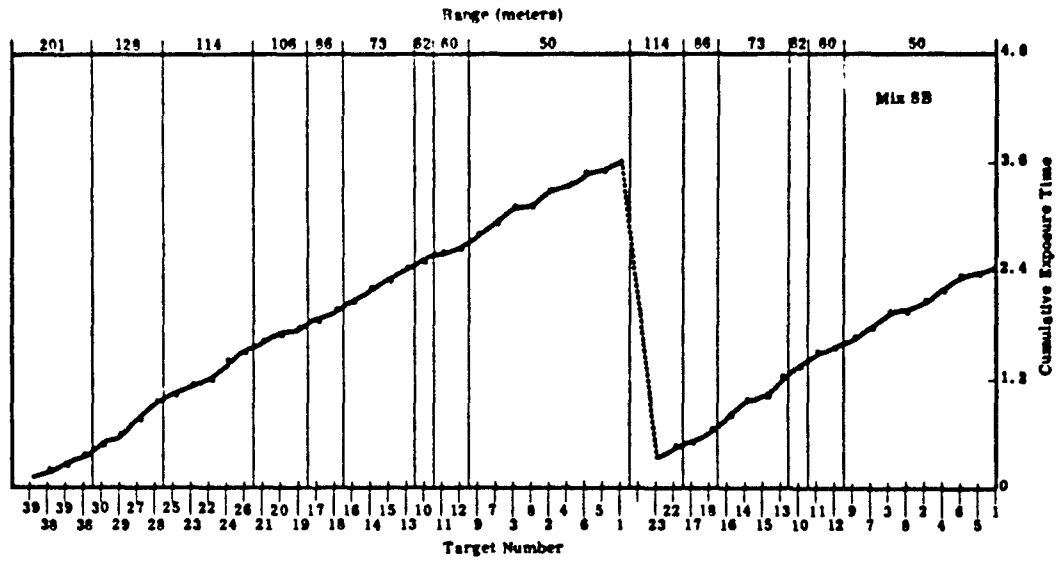
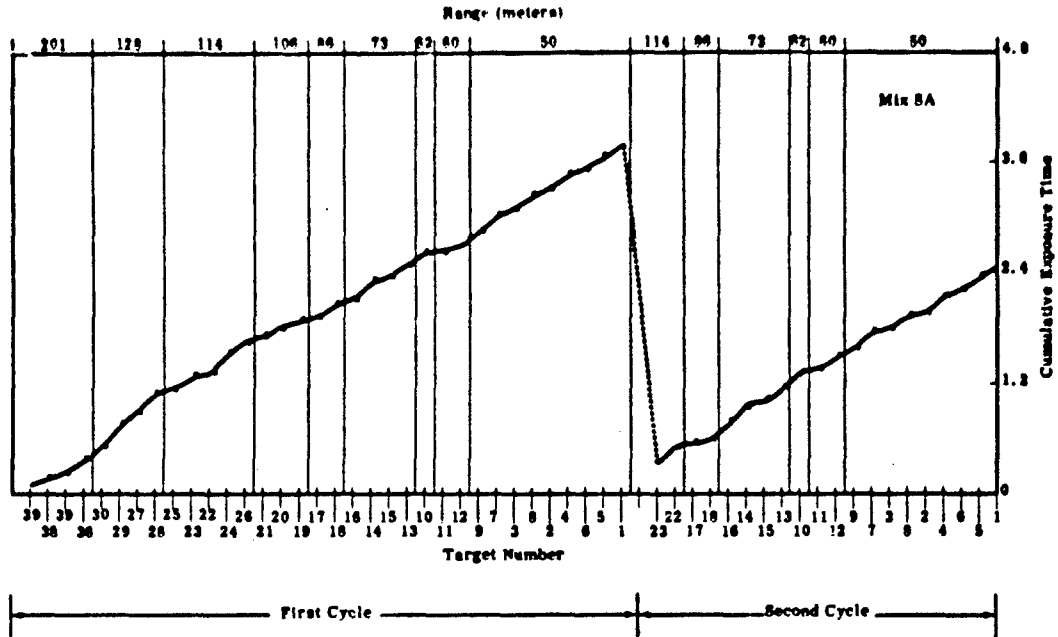

Figure 6-19 (Continued)  
CUMULATIVE EXPOSURE TIME--SITUATION 8

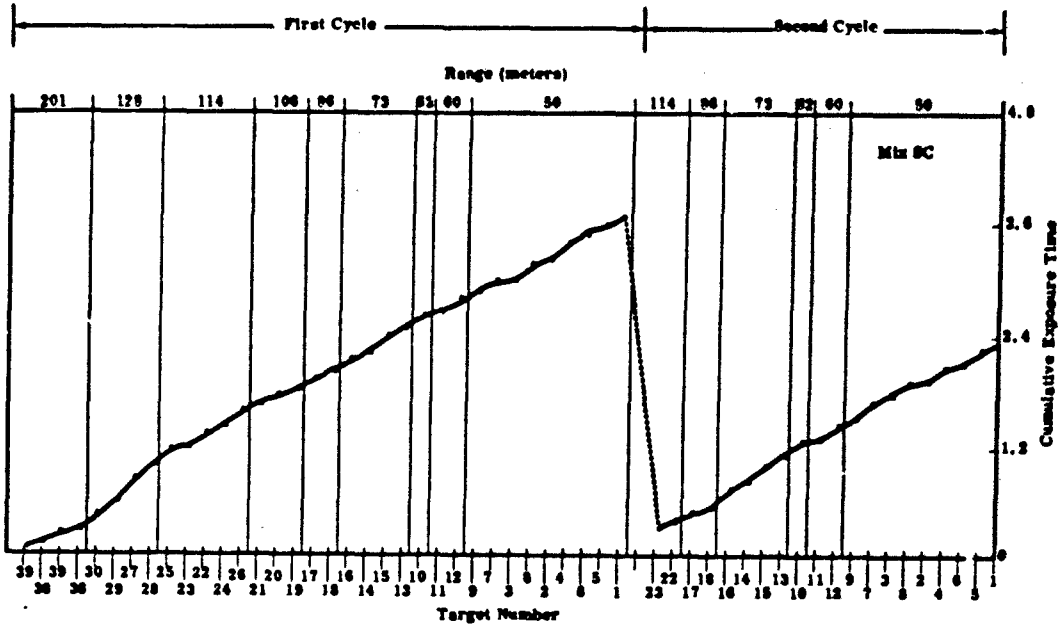

Figure 6-19 (Continued)  
CUMULATIVE EXPOSURE TIME--SITUATION 8

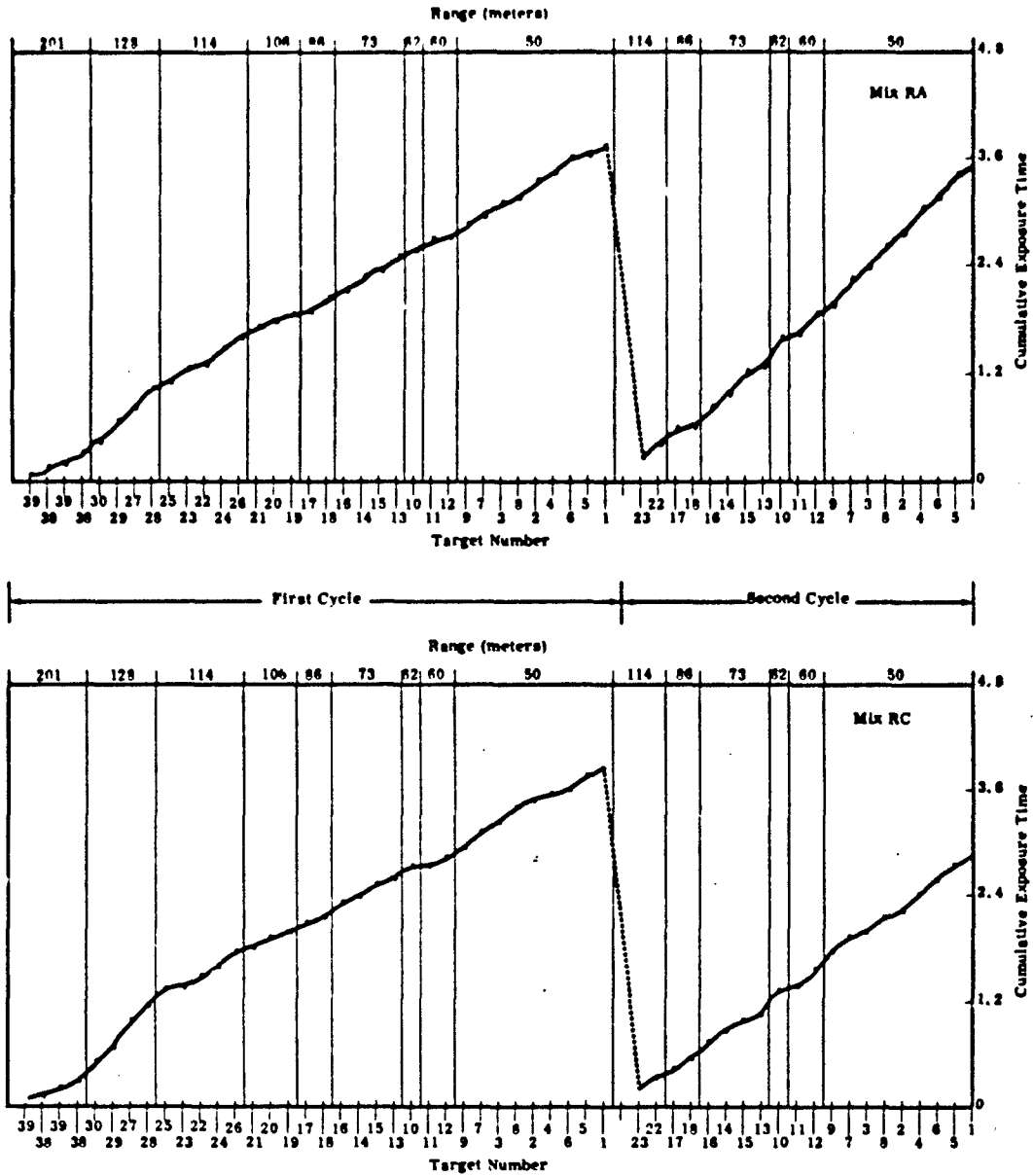

Figure 6-19 (Concluded)  
CUMULATIVE EXPOSURE TIME--SITUATION 8

## 7. Combined Results - Rifle Squad Experiment

Target effects and overall effectiveness scores were averaged, for illustrative purposes, across all six rifle situations, with each situation arbitrarily assigned a weight of equal importance. This does not imply that each situation should be weighted equally. The numerical values presented below do little more than serve as a base for varying the judged value of the different situations. In like manner, overall standard scores for each situation should be considered the result of arbitrarily weighting target effects two-thirds and sustainability one-third.

Sensitivity analyses have shown, however, that the rank orders of the weapon systems are remarkably insensitive to changes in weighting. For example, because Mix UC (five M14 rifles and two M60 machineguns) never ranks higher in target effects than seventh place in any situation, Mix UC can never rank higher than the bottom half in target effects, no matter how much weight is given to a particular situation. Mix UC was also inferior in target effects to Mix UA (composed entirely of M14 rifles) in every situation but the night defense, and even in this situation Mix UC was in seventh place, with Mix UB in sixth place and Mix UA a close eighth. In overall effectiveness, Mix UA was also superior to Mix UC in five of the six situations. It is therefore concluded that the M60 machinegun is not satisfactory for inclusion in the rifle squad.

The deficiencies of the M60 machinegun and its low standing among other weapon mixes are attributed to the heavy system weight that required a two-man crew, the difficulty of managing such a heavy weapon in the moving firing situations, and the fact that even with a two-man crew its sustainability is marginal.

The opposite is true for Mix SC (seven Stoner rifles and two Stoner machineguns). This mix was among the top three in target effects in every situation. It was also superior in target effects to every US 7.62mm weapon mix, regardless of the situation. In sustainability, it dropped in rank order, but in overall effectiveness combined across all situations, it ranked fourth, again superior to every US 7.62mm mix. This was despite the Stoner machinegun being subject to numerous malfunctions and stoppages caused by faulty ammunition and improperly manufactured belt links. It was nevertheless still able to finish first in combined target effects for all situations. It is therefore concluded that the Stoner machinegun can be feasibly included in the rifle squad in the automatic rifle role, or possibly in a new squad organization in the role of a machinegun.

Mix UA (composed entirely of M14 rifles) is superior to all other US 7.62mm mixes in target effects, sustainability, and overall effectiveness, while Mix UB (seven M14s and two M14E2) and Mix UD (nine M14E2s) are seventh and ninth, respectively, in target effects,

and seventh and tenth in overall effectiveness. It is therefore concluded that a squad equipped entirely with M14 rifles is superior to a squad equipped with any other US 7.62mm weapon or combination of these weapons. In like manner, it is concluded that the M14E2 is not satisfactory for use in the rifle role.

It had been hypothesized before the experiment that the Colt rifle and similar weapons with straight stocks and high sights would be inferior in pointing fire, because the barrel is low in relation to the sights and because the weapon is short. This was not supported by experimentation data. To the contrary, Situation 4 (Approach to Contact), which was specifically developed to investigate pointing fire, shows that the top ranking mix in overall effectiveness was the mix composed of nine Colt rifles. This mix also ranked second in target effects. The variability of squads was large in this situation, and while Mix CA was first, Mix CB was only fifth in overall effectiveness and seventh in target effects. Although the variability of the rank orders and weapon system scores is too much to conclude that there is a real difference, the trend favors the Colt rifle with its high sight and straight stock.

The AK47 scores are low in all situations except in the pointing fire in Situation 4. However, it cannot be concluded that the low target effects of the AK47 rifle in this experiment are necessarily indicative of the performance of the AK47 in general. Its barrel is only 16 inches long and the sights are close together. It seems to be designed primarily as a submachinegun-type weapon. If the SAWS results were weighted by range in accordance with the frequency of ranges of actual combat, it would be expected to do much better. These weapons had also received heavier wear than the other experimentation weapons. They had all been well used when received for the SAWS experiment, and the number of rounds previously fired from them was unknown. Because of the limited number of weapons, five firers usually shared each weapon. There were no spares for worn or broken parts, except for other worn parts cannibalized from other weapons, and there was a variability in the design and quality of the ammunition. All of these things may have contributed to the relatively poor performance of the AK47.

The results in terms of rank order and standard scores for overall target effects and overall effectiveness across all situations are presented in the following tables.

These tables, examined in connection with the statistical tables and graphs for each situation, lead to the conclusion that low impulse 5.6mm weapons are markedly superior to high impulse 7.62mm weapons in target effects, sustainability, and overall effectiveness. Mix SC (seven Stoner rifles and two Stoner machineguns) was superior in target effects, while Mix CB (seven Colt rifles and two Colt machineguns) was outstanding in overall effectiveness. However, results of later

experimentation (described in Part B) indicate that a squad equipped with only Colt automatic rifles may be superior to any of the mixes listed in the tables here.

**TARGET EFFECTS ONLY**

Rank Order by Situation						
Rank	Situation					
	1	2	4	5	7	8
1	SB	CA	SC	SA	CB	SB
2	SA	SC	CA	CB	SC	SC
3	UB	UB	SB	SB	SB	CB
4	SC	UA	UA	SC	UA	SA
5	CB	CB	RA	UA	CA	CA
6	CA	UD	UB	UD	SA	UB
7	UA	SB	CB	UC	RA	UC
8	RA	UC	UD	CA	UB	UA
9	UC	SA	SA	UB	UC	RA
10	UD	RA	UC	RA	UD	UD

Rank Order (All Six Situations Combined)		
Rank	Mix	Std. Score
1	SC	63.35
2	CB	63.26
3	SB	60.30
4	SA	57.79
5	CA	53.70
6	UA	52.16
7	UB	46.61
8	UC	41.33
9	UD	34.93
10	RA	29.88



**OVERALL EFFECTIVENESS <sup>A</sup>**

Rank Order by Situation						
Rank	Situation					
	1	2	4	5	7 <sup>B</sup>	8
1	CB	CA	CA	SA	CB	CB
2	SB	CB	UA	CB	CA	SB
3	SA	UA	RA	SB	SC	SC
4	UB	SC	SC	SC	SB	SA
5	CA	UB	CB	CA	UA	CA
6	SC	UD	SB	UA	SA	UC
7	UA	SA	UB	UD	RA	UB
8	RA	SB	SA	UC	UC	UA
9	UD	UC	UC	RA	UB	RA
10	UC	RA	UD	UB	UD	UD

Overall Rank Order <sup>B</sup> (All Six Situations Combined)		
Rank	Mix	Std. Score
1	CB	67.70
2	CA	63.27
3	SA	59.47
4	SC	58.41
5	SB	58.23
6	UA	52.38
7	UB	45.32
8	UC	38.93
9	RA	35.12
10	UD	33.93

<sup>A</sup> Sustainability weighted 1/3; target effects weighted 2/3

<sup>B</sup> Series 1 Integrated Scores

**Key:**

UA - 9 M14 Rifles

UD - 9 M14E2 Rifles

UB - 7 M14 Rifles and  
2 M14E2 AR

UC - 5 M14 Rifles and  
2 M60 MG

SA - 9 Stoner Rifles

RC - 7 AK47 Rifles and  
2 RPD MG

SB - 7 Stoner Rifles and  
2 Stoner AR

SC - 7 Stoner Rifles and  
2 Stoner MG

CA - 9 Colt Rifles

CB - 7 Colt Rifles and  
2 Colt AR

RA - 9 AK47 Rifles

## B. SUPPLEMENTARY RIFLE SQUAD EXPERIMENT

Three special weapons mixes were fired in addition to the weapon mixes already described. These mixes were MC (seven Colt rifles and two Stoner machineguns), CY(S) (nine Colt automatic rifles), and CY(T) (nine Colt rifles). Three control mixes were fired: MB (seven Colt rifles and two Colt automatic rifles), CX(T) (nine Colt rifles), and CX(S) (nine Colt rifles). The (S) and (T) denote semiautomatic and two-round burst, respectively. The effects of these mixes for Situations 1, 2, 4, 5, 7, and 8 are presented in Table 6-1.

### 1. MC Versus MB

Analysis of the table shows that in terms of both target effects and sustainability there is a great deal of variation across the six rifle situations. Generally speaking, Mix MC is better in target effects in three of the six situations, although never by a tactically significant amount. In the other three situations, Mix MC and Mix MB are equal in target effects. In three of the six situations, however, MB is better than MC in sustainability, while in two situations the mixes are equal. Mix MC is slightly better (4 percent) in the remaining situation--an advantage that could be due to chance factors. Therefore, it is concluded that there are no tactically significant differences in overall effectiveness between Mix MC (seven Colt rifles and two Stoner machineguns) and Mix MB (seven Colt rifles and two Colt automatic rifles). In effect, as both mixes had seven rifles, it can be concluded that two Colt automatic rifles are equivalent to two Stoner machineguns. Note that in experimentation results for the September 1965 to December 1965 experimentation, it was concluded that the Stoner and Colt rifles were approximately equivalent in target effects. Also the scores of Mix SC (seven Stoner rifles and two Stoner machineguns) and Mix CB (seven Colt rifles and two Colt automatic rifles), when totalled for all six situations, were the two top ranking mixes with almost identical scores in overall target effects: 64.5 and 62.8. Thus the equivalence of Stoner rifles and Colt rifles, as well as Colt automatic rifles and Stoner machineguns, becomes apparent. When sustainability is considered, however, a mix composed of seven Colt rifles and two Colt automatic rifles becomes clearly superior in overall effectiveness.

### 2. CX Versus CY

Results show that Mix CY (nine Colt automatic rifles) is superior to Mix CX (nine Colt rifles) in terms of target effects achieved. However, this increase in target effects is traded for an approximate 11.5 percent loss in sustainability caused by the increased weight of the Colt automatic rifle. Mix CX (nine Colt rifles) is superior to Mix CY in sustainability. However, the Colt automatic rifle, although heavier than the Colt rifle, can still, within its 17-pound system weight, carry 265

**Table 6-1**  
**EFFECTS OF SPECIAL WEAPON MIXES**

Mix	CET (Minutes)	Near Misses	Sustainability	Target Hits	Total Hits
<b>Situation 1</b>					
MC	26.35	632.76	56.75	3.37	3.49
MB	26.82	590.34	64.43	3.69	3.96
CY(T)	25.86	593.81	61.45	4.06	4.56
CY(S)	25.92	571.39	64.08	5.64	5.64
CX(T)	26.84	529.67	68.86	2.28	2.28
CX(S)	25.50	441.57	71.26	4.91	5.43
<b>Situation 2</b>					
MC	82.20	421.25	31.25	9.00	9.20
MB	85.47	420.25	40.09	8.38	8.54
CY(T)	85.19	441.00	38.86	8.25	8.75
CY(S)	79.93	426.00	38.62	10.75	10.75
CX(T)	86.38	405.75	44.72	7.75	8.00
CX(S)	85.59	364.25	56.13	8.25	9.00
<b>Situation 4</b>					
MC	1.94	--	76.54	29.62	45.88
MB	2.00	--	78.08	30.50	50.12
CY(T)	1.91	--	73.01	32.00	52.75
CY(S)	1.97	--	87.86	32.25	52.50
CX(T)	1.91	--	77.85	31.00	46.75
CX(S)	1.82	--	90.61	31.75	45.75

Table 6-1  
EFFECTS OF SPECIAL WEAPON MIXES (Concluded)

Mix	CET (minutes)	Near Misses	Sustainability	Target Hits	Total Hits
Situation 5					
MB	32.99	257.50	63.78	12.12	13.76
MC	35.48	279.62	58.95	10.88	11.42
CY(T)	38.10	268.75	34.68	8.75	10.25
CY(S)	39.63	256.50	35.51	8.50	8.50
CX(T)	38.52	255.00	49.38	8.50	9.00
CX(S)	41.49	184.00	45.42	6.25	6.50
Situation 7					
MC	4.38	--	68.62	52.50	93.38
MB	4.39	--	64.82	53.50	94.63
CY(T)	4.60	--	71.03	50.25	87.25
CY(S)	4.76	--	84.75	51.50	83.00
CX(T)	5.01	--	75.61	51.50	80.25
CX(S)	4.61	--	85.18	51.25	78.25
Situation 8					
MC	5.47	--	55.41	31.13	55.25
MB	5.58	--	54.45	29.00	48.86
CX(T)	5.30	--	58.57	33.50	59.75
CX(S)	4.69	--	55.57	36.25	64.25
CY(T)	4.92	--	57.55	35.75	65.50
CY(S)	4.83	--	56.93	34.50	58.00

rounds as opposed to 100 for the M14, 180 for the Stoner rifle, and 300 for the Colt rifle. The additional weight of the barrel is equal to one full 30-round magazine plus five rounds. Thus, the Colt automatic rifle although able to carry 35 -rounds less ammunition than the Colt rifle, is still a lighter weapon, and can carry more ammunition than any of the other rifles or automatic rifles. The heavier barrel also allows the weapon to sustain its fire longer than the Colt rifle without damage to the barrel.

### 3. MC Versus CY

A comparison of Mix CY (nine Colt automatic rifles) with Mix MC (seven Colt rifles and two Stoner machineguns) shows the two mixes are approximately equal in target effects but that Mix CY has a slight advantage in sustainability. This portion of the experiment therefore indicated that the most feasible weapon mix may be one equipped entirely with Colt automatic rifles.

In all identical rifle situations during the entire experiment, mixes composed of nine rifles compared favorably, and did better in some cases, with mixes composed of seven rifles and two machineguns. Furthermore, when the scores secured by seven-man machinegun squads in the machinegun experiment are compared to the scores of the nine-man rifle squads in corresponding situations, the nine-man rifle squads are found generally superior to the machinegun squads in target effects, sustainability, and overall effectiveness. Table 6-2 compares the scores for the top ranking rifle squad mixes and the scores representing the average of all rifle squad mixes for each measure of each situation with the scores for the top ranking machinegun squad for each measure of each situation. Also given are the scores of the squad mix equipped entirely with Colt automatic rifles in their best mode of fire. The scores for the machinegun squads mix and the mix composed of Colt automatic rifles are inflated because some of their members had previously fired in the various situations in the original rifle squad experiment.

These factors lead to the hypothesis that seven riflemen should be more effective than a seven-man machinegun squad (two guns with a squad leader, two gunners, two assistant gunners, two ammunition bearers). It does not seem unreasonable then to hypothesize the elimination of all small arms weapons but one. Squads equipped only with Colt automatic rifles might then replace all machinegun squads and all squads using both rifles and automatic rifles.

Further, it is judged that the increased target effects of Colt automatic rifles over the rifle are due to the additional stability offered by the heavier barrel. If this is so, the newly developed XM148 grenade launcher attachment for use on the Colt rifle should provide the extra weight necessary to achieve a stability for the Colt rifle comparable to

Table 6-2 COMPARATIVE SCORES OF SPECIAL WEAPON MIXES

Mix	CET (Minutes)	Near Misses	Sustainability	Target Hits	Total Hits
(Rifle Situation 1 - No Comparable Machinegun Situations)					
Rifle Situation 2 - Machinegun Situation 3					
Top MG Mix	87.8	273.8	41.8	6.8	7.8
Top Rifle Mix	77.5	345.0	50.5	10.7	12.6
Average All Rifle Squad Mixes	80.9	283.7	23.8	9.1	9.6
All Colt AR Mix	79.9	426.0	38.6	10.8	10.8
(Rifle Situation 4 - No Comparable Machinegun Situation)					
Rifle Situation 5 - Machinegun Situation SA					
Top MG Mix	40.0	198.5	69.3	7.9	8.3
Top Rifle Mix	38.6	207.3	84.8	8.9	10.2
Average All Rifle Squad Mixes	40.6	141.5	63.1	6.5	6.9
All Colt AR Mix	38.1	268.8	34.7	8.8	10.3
(Machinegun Situation G - No Comparable Rifle Situations)					
Rifle Situation 7 - Machinegun Situation 9					
Top MG Mix	8.0	--	79.9	43.0	67.0
Top Rifle Mix	4.1	--	94.8	56.0	90.5
Average All Rifle Squad Mixes	5.6	--	69.1	50.5	76.7
All Colt AR Mix*	4.60	--	71.0	50.3	87.3

\* NOTE: Colt automatic rifle scores in this table are based on automatic fire. The best rifle mix in CET (4.1 min) in this situation was Mix CB (seven Colt rifles and two Colt automatic rifles) when the rifles were firing semiautomatic fire. In Series 1, when the same mix CB fired automatic fire, the CET was an unsatisfactory 5.98 minutes. If the Colt automatic rifle squads had fired semiautomatic, their expected score would have been less than 4 minutes, which is superior to all other mixes.

that of the Colt automatic rifle. The only disadvantage would be a shorter barrel life during sustained fire because of the rifle's lighter barrel. Thus, providing the Colt rifle with a SPIW-type dual "area fire-point fire" capability may, at the same time, provide the extremely desirable additional effect of providing added stability and better point fire target effects commensurate with those of the Colt automatic rifle and Stoner machinegun.

These fire effectiveness results and hypotheses warrant further testing. If these hypotheses are valid, their implications would be revolutionary. The cost effectiveness and associated logistic advantages of one weapon to replace the present rifle, automatic rifle, grenade launcher, and machinegun, are unquestionable.

Such a choice becomes more imperative if the one weapon, for example, Colt rifle with XM148 grenade launcher attachment) suggested to replace all other weapons has a proven fire superiority in every role over each of the weapons that it is proposed to replace--rifle, automatic rifle, machinegun, and M79 grenade launcher.

Within the current weapons inventory, the choice therefore, seems to become one of choosing among:

- 1) A squad equipped entirely with Colt automatic rifles
- 2) A squad equipped entirely with Colt rifles with XM148 grenade launchers
- 3) A squad equipped with a combination of Colt automatic rifles and separate grenade launchers (such as the M79)

The answer can come only through additional fire effectiveness experimentation. It should be dealt with in the IRUS study.

**C. MACHINEGUN SQUAD EXPERIMENT**

**1. Situation 3: Machinegun Squad in Fire Support of the Assault**

This situation evaluated machinegun squad weapon mixes firing supporting fire from hastily prepared foxholes at partially concealed and unconcealed targets in foxholes at a range of 269 to 326 meters. Machineguns of the squad were positioned 25 meters apart and fired at the same target array as in Situation 2.

Mixes firing in Situation 3 were UF (M60 tripod, T&E), UE (M60 bipod), SF (Stoner tripod T&E), SE (Stoner bipod), RF (Soviet DPM bipod), and RE (Soviet RPD bipod). The first five mixes were fired before Mix RE, which was not available at the time. Mix RF did not fire tracer ammunition the first time, and was fired again with tracer with the RE mix. Stoner Mixes SE and SF are not directly comparable to the other three mixes because of excessive misfires caused primarily by faulty ammunition (see Table 5-1).

Results for Situation 3 appear below, the first five squad firings first, followed by the later RE and RF firings.

Mix	CET	Near Misses	Percent Ammunition Remaining	Targets Hit	Total Hits
UF	87.79	273.8	41.8	6.8	7.8
UE	92.58	246.3	51.2	4.2	5.0
SF	94.09	139.3	84.7	3.4	4.0
SE	95.38	99.2	88.3	3.0	3.1
RF	96.03	109.2	70.5	3.3	3.8

Mix	CET	Near Misses	Percent Ammunition Remaining	Targets Hit	Total Hits
RE	92.87	246.6	51.2	5.8	6.0
RF	99.06	119.5	64.0	3.0	3.3

**2. Situation 5A: Machinegun Squad as a Base of Fire Supporting the Advance (375 to 560 meters)**

Machinegun squad mixes fired on two arrays of enemy targets from unprepared firing positions. Duration of fire was 4 minutes, with the first 2 minutes directed toward an array of 14 targets occupying an area 60 meters wide and 42 meters deep. The range from firers to



targets was 379 to 445 meters. The second 2 minutes of fire was delivered against an array of 13 targets occupying an area 45 meters wide and 62 meters deep, at ranges of 477 to 560 meters. The technique of fire employed was distributed fire throughout the sector, with point fire used when targets were seen or when weapon simulators gave specific cues to a target location. All firers had previously fired on these same arrays but from different positions. A summary of data is presented below.

Mix	CET	Near Misses	Percent Ammunition Remaining	Targets Hit	Total Hits
UF	40.03	198.5	69.29	7.92	8.30
UE	41.98	189.3	72.18	5.83	5.83
RE	42.25	120.0	89.52	5.10	6.10
SE	42.98	89.0	93.88	4.60	5.20
SF	44.13	107.3	91.80	3.17	3.67
RF	45.01	63.0	85.25	2.12	2.12

**3. Situation 6: Machinegun Squad in Fire Support of the Advance (446 to 753 meters)**

This situation evaluated machinegun squad weapon mixes against 40 targets with a programmed total target exposure time of 66.380 minutes. The targets were divided into three target arrays, X, Y, and Z. Ranges for Array X were from 603 to 646 meters, for Array Y from 690 to 753 meters, and Array Z from 446 to 488 meters. The programmed total target exposure time for Array X was 22.256 minutes (see Table B-21).

The machineguns firing Situation 6 were the same as those fired in Situation 3. Note that the Stoner machineguns had excessive stoppages (see Table 5-1) caused by faulty ammunition, and are therefore not directly comparable to the other mixes. Because of different firing conditions, the Soviet mixes (RE and RF) are also not directly comparable to the other machinegun mixes.

Mix	CET	Near Misses	Percent Ammunition Remaining	Targets Hit	Total Hits
UF	56.48	308.16	65.47	12.17	13.83
SF	63.07	183.17	89.86	6.00	7.00
UE	63.59	228.00	78.49	6.00	7.00
RE	64.49	133.20	93.41	6.40	6.80
SE	66.78	100.67	94.85	4.33	4.83
RF	68.82	50.75	82.61	2.25	1.26

4. Situation 9: Machinegun Squad in Defense Against Attack

This situation evaluated the machinegun squad and mixes firing from hastily prepared foxholes at visible targets advancing from 345 to 45 meters. There were 50 targets, some of them appearing more than once. Their programmed total target exposure time was 15.976 minutes (see Table B-22 and Range B Sketch Map, Annex B.)

Mix	CET	Near Misses	Percent Ammunition Remaining	Targets Hits	Total Hits
UF	8.03	--	79.92	43.08	66.98
RF	8.59	--	82.33	40.37	57.23
SF	8.81	--	90.86	39.65	68.27
SE	8.94	--	95.24	38.92	59.78
UE	9.13	--	88.10	39.45	65.05

Mix	CET	Near Misses	Percent Ammunition Remaining	Targets Hit	Total Hits
RE	9.37	--	87.87	35.40	60.20
RF*	9.96	--	80.98	34.50	51.50

\* Second series for Mix RF

5. Discussion

The M60 tripod mounted machinegun mix was consistently better than the M60 bipod mounted mix. The poor performance of the Stoner machinegun mixes, particularly in sustained fire (Situations 3 and 6), was caused by a high rate of misfires. The Stoner machinegun fired 20 percent less ammunition than the M60 although it has a higher rate of field fire. (See Section V, Materiel Reliability.) Gunners often had to recharge the Stoner weapons. This necessitated relaying and prevented effective adjustment of fire.

The Stoner machineguns did better in the day defense situation than in the other two situations. They ranked third and fourth behind the tripod mounted M60 and Soviet DPM and ahead of the bipod mounted M60 in CET. This situation, because it did not emphasize sustained fire, made fewer demands on mechanical reliability than did the base of fire situations. There were intervals between target appearances that sometimes allowed stoppages to be cleared, but firing time was still lost.

For these reasons, and because of a difference in time frame for the firing of the Soviet weapons, the experimentation results provide no basis for directly evaluating any of the experimentation machinegun types against one another in the machinegun role.

## SECTION VII

### DUPLEX AMMUNITION EXPERIMENT

#### A. RIFLE DUPLEX AMMUNITION EXPERIMENT

The US 7.62mm M14 rifle squad mixes (UA and UB) were fired in December 1965 and January 1966 in an experiment designed to compare the effectiveness of duplex ball ammunition and simplex ball ammunition for rifles.

Because the squads had already fired each situation during the earlier rifle experiment, they were generally familiar with the ranges; consequently, the duplex scores could not be compared directly with the earlier scores of the other 5.56mm and 7.62mm rifle mixes.

To allow an adjustment whereby the effects of squads firing duplex ammunition could be directly compared with other mixes, Mixes UA (nine M14 rifles) and UB (seven M14 rifles and two M14E2 automatic rifles) were divided. Three squads of each mix fired the duplex experiment, while a control group fired ball ammunition and the other three squads fired duplex ammunition. In both the duplex and ball ammunition squads, the firers in the two automatic rifle foxholes fired tracer and ball ammunition in the same modes of fire as in Series 1. Thus, the ammunition and firing modes for the two automatic rifle position remained constant for both duplex and ball ammunition squads for both mixes. Consequently, any differences in fire effectiveness can be attributed to the effects of the ball ammunition or duplex ammunition being used by the riflemen in the seven positions other than the automatic rifle positions (2 and 8 in Situation 1; 3 and 7 in Situations 2, 4, and 5; 4 and 7 in Situations 7 and 8).

By the use of control groups firing ball ammunition, the increase in scores as a result of learning and similar effects could be computed. Thus, the percentage of the increase in scores of squads firing duplex that was due to learning and the percentage that was due to duplex ammunition could be determined. These figures were then used to compute the score for the UA and UB mixes that would have been expected had the mixes fired duplex ammunition instead of ball ammunition their first time in each situation (Series 1). These adjusted scores ("expected" duplex scores) are directly comparable with the scores of other rifle mixes in the original rifle squad experiment.

The results are presented in two tables. Table 7-1 shows the raw scores of the duplex squads compared with the control squads firing ball ammunition for each of the six rifle squad situations. Probability

**Table 7-1  
RAW SCORE RESULTS  
(Rifle Duplex Experiment)**

Effectiveness Measures	Duplex		Ball		t	p
	$\bar{X}$	SD	$\bar{X}$	SD		
<b>Situation 1 - Rifle Squad in Line Assault</b>						
CET (min.)	21.66	2.06	21.52	3.27	0.090	> 0.400
Near Misses	680.00	44.20	399.83	71.25	8.186	< .001
Sustainability	65.10	5.64	61.42	5.60	1.135	.142
Targets Hit	7.31	2.81	7.66	2.26	0.239	> .400
Total Hits	8.33	2.69	8.46	2.44	0.090	> .400
<b>Situation 2 - Rifle Squad as Base of Fire Supporting the Assault</b>						
CET (min.)	74.03	8.64	80.50	6.27	1.372	.103
Near Misses	412.20	93.29	308.00	44.33	2.470	.018
Sustainability	14.57	8.64	15.58	5.47	0.226	> .400
Targets Hit	13.50	3.39	11.25	2.22	1.269	.124
Total Hits	15.17	3.76	12.00	2.94	1.488	.090
<b>Situation 4 - Rifle Squad in Approach to Contact</b>						
CET (min.)	1.78	0.054	1.87	0.26	0.827	.216
Near Misses	--	--	--	--	--	--
Sustainability	59.05	9.87	69.58	7.43	2.088	.034
Targets Hit	31.83	2.48	32.17	3.06	0.211	> .40
Total Hits	78.67	8.31	48.50	11.15	5.314	< 0.001

**Table 7-1**  
**RAW SCORE RESULTS**  
**(Rifle Duplex Experiment) (Concluded)**

Effectiveness Measures	Duplex		Ball		t	p
	$\bar{X}$	SD	$\bar{X}$	SD		
<b>Situation 5 - Rifle Squad as Base of Fire Supporting the Advance</b>						
CET (min.)	37.88	3.99	39.14	4.61	0.506	0.313
Near Misses	229.33	76.15	138.33	67.75	2.187	.027
Sustainability	46.83	9.03	52.37	6.20	1.239	.124
Targets Hit	7.33	2.25	7.67	2.66	0.239	>.400
Total Hits	9.50	4.09	8.17	3.19	0.628	.273
<b>Situation 7 - Rifle Squad in Defense Against Attack</b>						
CET (min.)	4.35	0.7	4.40	1.1	0.12	>.40
Near Misses	--	--	--	--	--	--
Sustainability	43.2	13.0	50.5	12.5	1.21	.12
Targets Hit	53.0	2.1	52.7	2.3	0.29	.39
Total Hits	114.3	10.4	91.1	11.5	4.49	.0005
<b>Situation 8 - Rifle Squad in Night Defense</b>						
CET (min.)	6.33	0.3	6.78	0.2	3.7	.002
Near Misses	--	--	--	--	--	--
Sustainability	19.4	3.5	27.1	12.5	1.8	.04
Targets Hit	17.6	3.4	17.0	2.9	0.4	.35
Total Hits	39.0	12.3	30.9	7.9	1.7	0.07

values (p) have been computed, using a two-sample t-statistic (see Section III, page 3-3, for an explanation of probability values).

Table 7-2 shows the expected duplex scores. These are the scores that would have been expected if the rifle squads had fired duplex instead of ball ammunition in this first firing of the various situations. The first firing scores were adjusted by applying mathematical corrections derived from the first firing scores of the original rifle squad experiment and the duplex experiment firing scores of all six squads of each mix. The scores are directly comparable and represent the contributions of all six squads of each mix. The scores in each case represent the average score of Mix UA and UB combined.

Duplex ammunition provides an advantage in near misses in the assault (125 to 15 meters). An advantage would then also be expected to accrue on the number of concealed undetected targets hit; however, in terms of hits and total number of hits on detected targets, there is no improvement evident as a result of firing duplex in the assault situation (Figures 7-1 and 7-2).

In the approach to contact situation (Pointing Fire, 15 to 163 meters), there are no tactically significant differences between duplex and ball ammunition, except for the total number of hits on targets that were hit. No more targets were hit by using duplex, but when a target was hit by a squad using duplex, it was hit with an average of 2.5 to 3 bullets (Figure 7-3).

In the longer range supporting fire of Situation 5 (390 to 545 meters), duplex ammunition provided a significant increase in the number of near misses and possibly a small increase in the total number of hits on targets that were hit. There was no increase in the number of targets hit. However, in the shorter range supporting fires of Situation 2 (300 meters), duplex ammunition resulted in increases in all target effects (CET, near misses, number of targets hit, and total number of hits) (Figures 7-4 through 7-7).

In Situations 7 and 8, aimed fire against visible point targets (45 to 320 meters), duplex ammunition provided a clear superiority in the total number of hits on targets that were hit. Although a small numerical advantage in the number of targets hit accrued in this situation, the large variability in squad scores indicates this difference is the result of chance variations (Table 7-1). See Figures 7-8 and 7-9 for cumulative exposure time by range and target.

In five of the six rifle situations, the number of rounds fired by the squads using duplex ammunition was greater than for the squads using ball ammunition. The reason cannot be explained. Since both groups had equal experience on the range, equal training, and equal weapons, it was hypothesized that both would fire the same amount of ammunition. This result merits further investigations.

**Table 7-2**  
**EXPECTED DUPLEX SCORE**  
**(Rifle Duplex Experiment)**

Effectiveness Measures	Original Ball Ammunition Score (UA and UB)	Expected Duplex Score
<b>Situation 1 - Rifle Squad in Line Assault</b>		
CET (min.)	24.8	26.3
Near Misses	314.2	448.0
Sustainability	46.4	59.7
Targets Hit	4.5	3.8
Total Hits	4.6	4.0
<b>Situation 2 - Rifle Squad as Base of Fire Supporting the Assault</b>		
CET (min.)	78.8	72.4
Near Misses	285.5	382.6
Sustainability	16.2	17.0
Targets Hit	10.4	14.2
Total Hits	11.5	18.1
<b>Situation 4 - Rifle Squad in Approach to Contact</b>		
CET (min.)	2.05	2.01
Near Misses	--	--
Sustainability	75.2	62.1
Targets Hit	30.4	27.9
Total Hits	47.1	83.1



**Table 7-2**  
**EXPECTED DUPLEX SCORE**  
**(Rifle Duplex Experiment) (Concluded)**

<b>Effectiveness Measures</b>	<b>Original Ball Ammunition Score (UA and UB)</b>	<b>Expected Duplex Score</b>
<b>Situation 5 - Rifle Squad as Base of Fire Supporting the Advance</b>		
CET (min.)	41.4	41.0
Near Misses	118.3	179.7
Sustainability	57.4	51.0
Targets Hit	5.7	6.7
Total Hits	5.7	6.7
<b>Situation 7 - Rifle Squad in Defense Against Attack</b>		
CET (min.)	5.9	5.6
Near Misses	--	--
Sustainability	61.3	51.3
Targets Hit	48.3	48.6
Total Hits	71.3	96.3
<b>Situation 8 - Rifle Squad in Night Defense</b>		
CET (min.)	6.8	6.4
Near Misses	--	--
Sustainability	44.9	36.3
Targets Hit	20.6	20.8
Total Hits	25.6	30.9

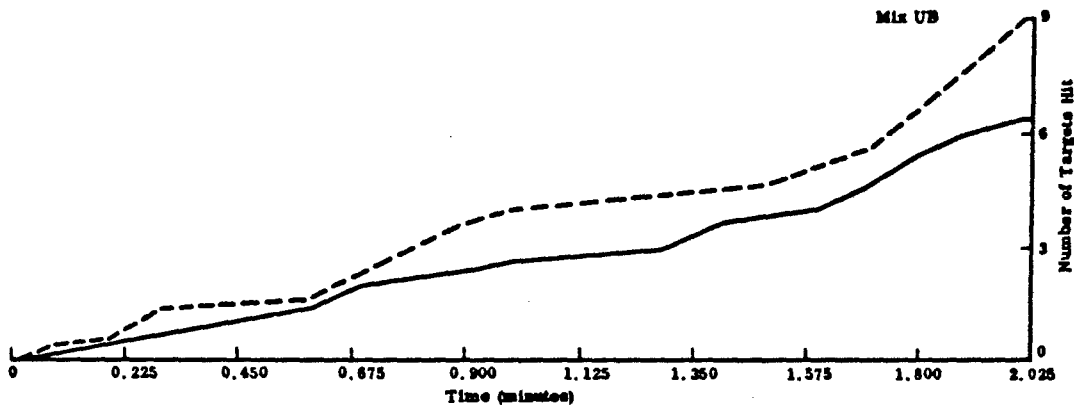
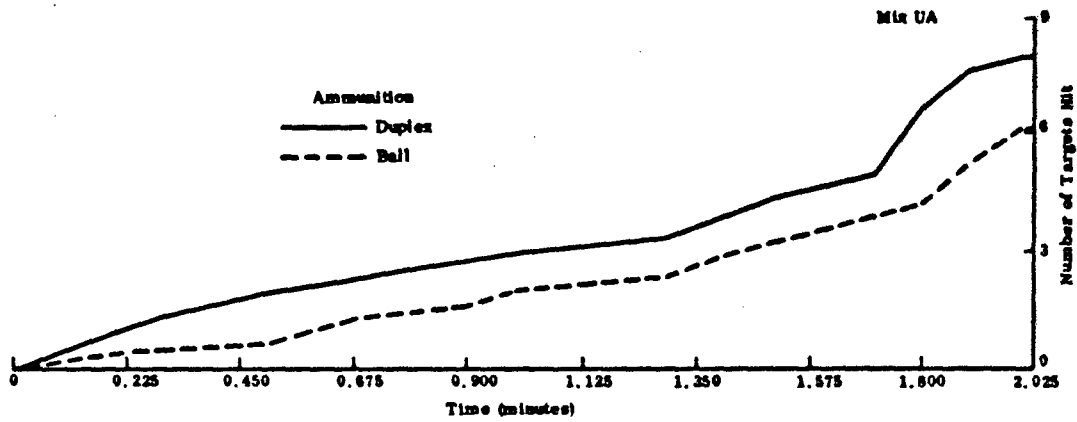

Figure 7-1  
CUMULATIVE NUMBER OF TARGETS HIT--SITUATION 1

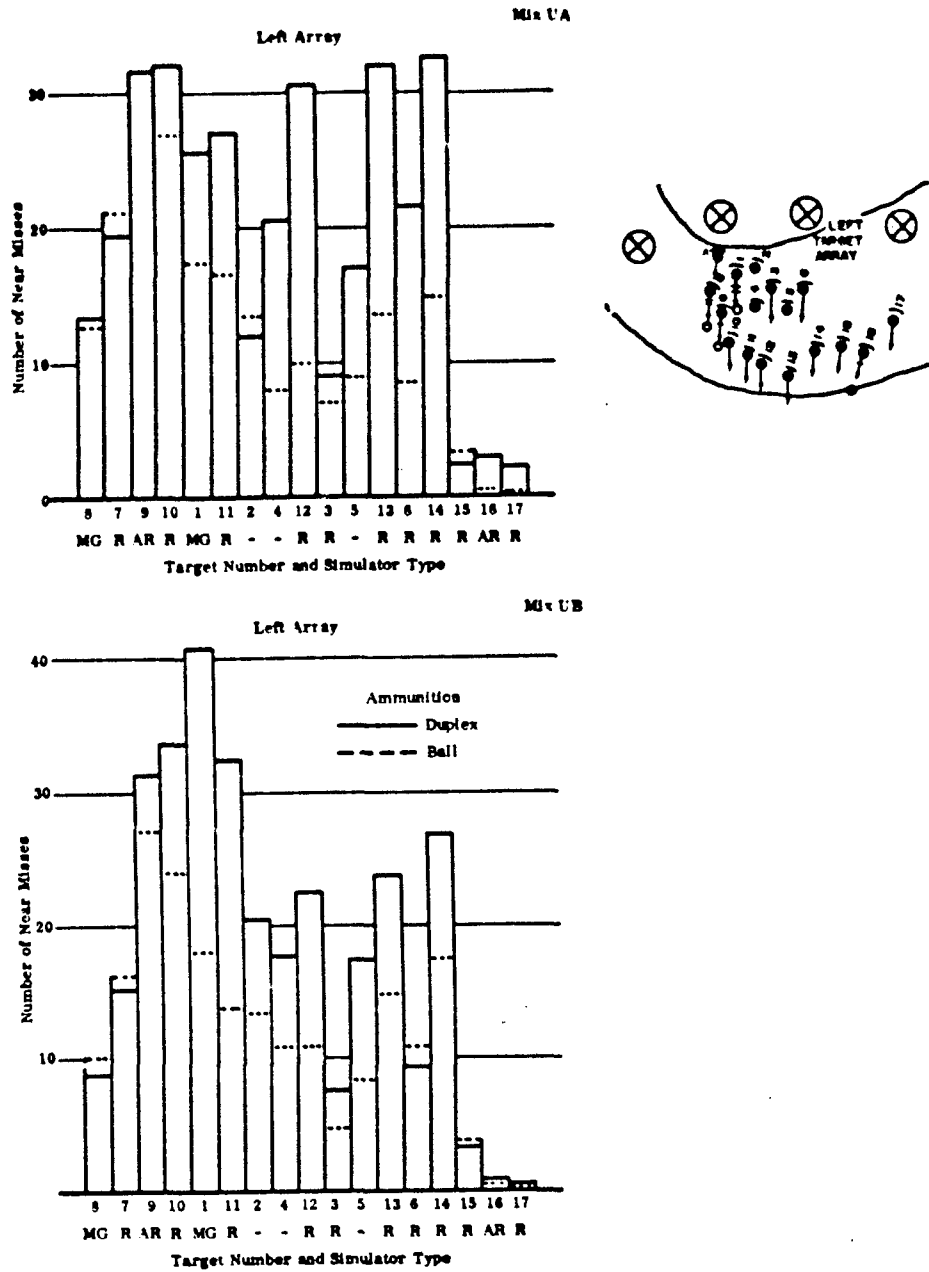

Figure 7-2  
 NUMBER AND DISTRIBUTION OF NEAR MISSES--  
 SITUATION 1

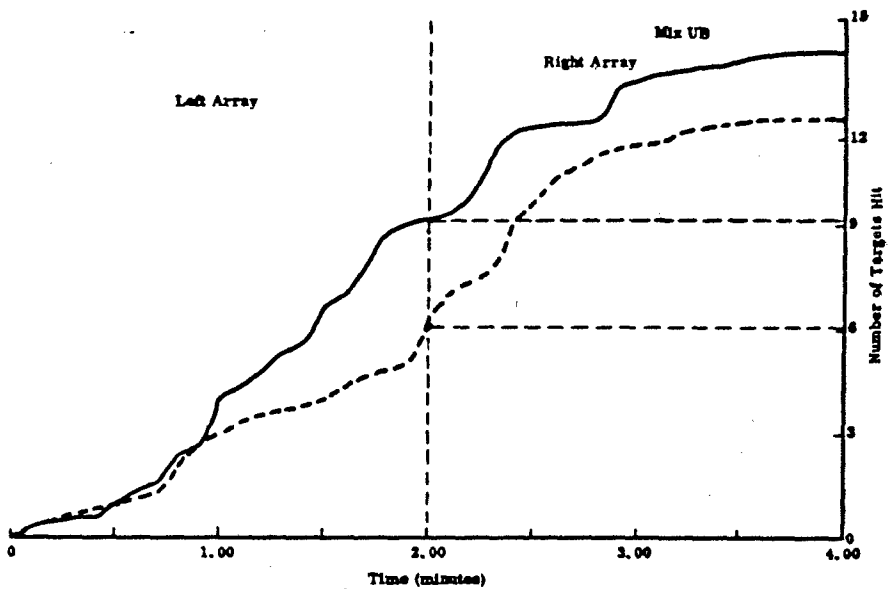
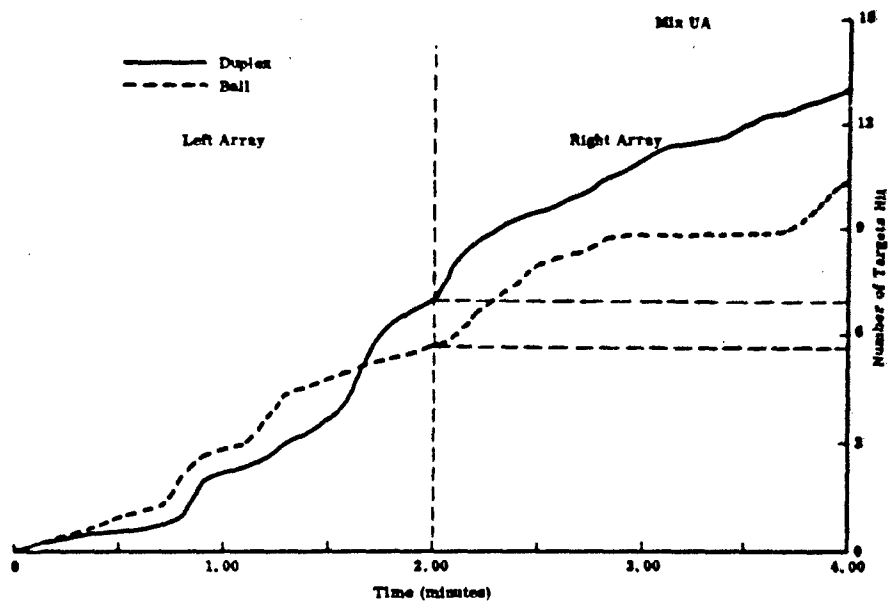

Figure 7-3  
CUMULATIVE NUMBER OF TARGETS HIT--SITUATION 2

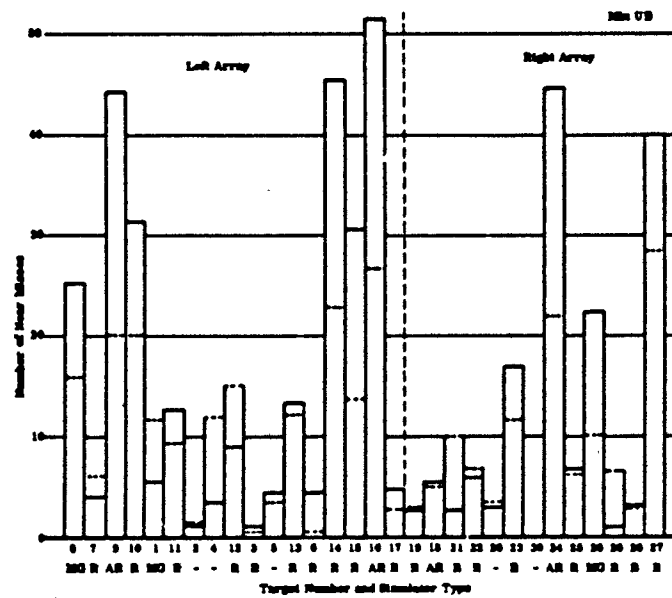
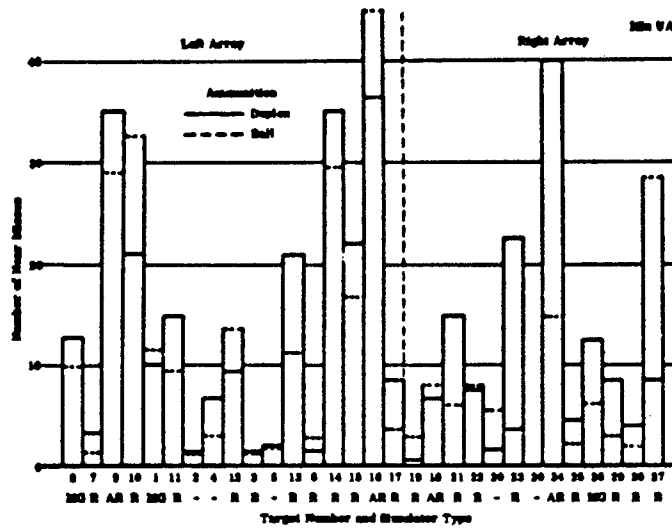
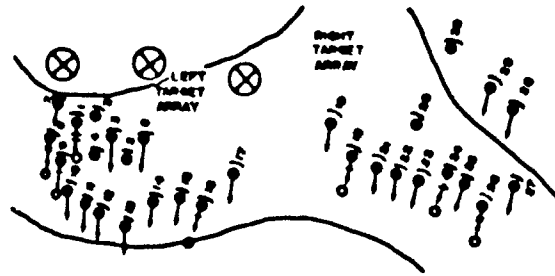

Figure 7-4 NUMBER AND DISTRIBUTION OF NEAR MISSES--SITUATION 2

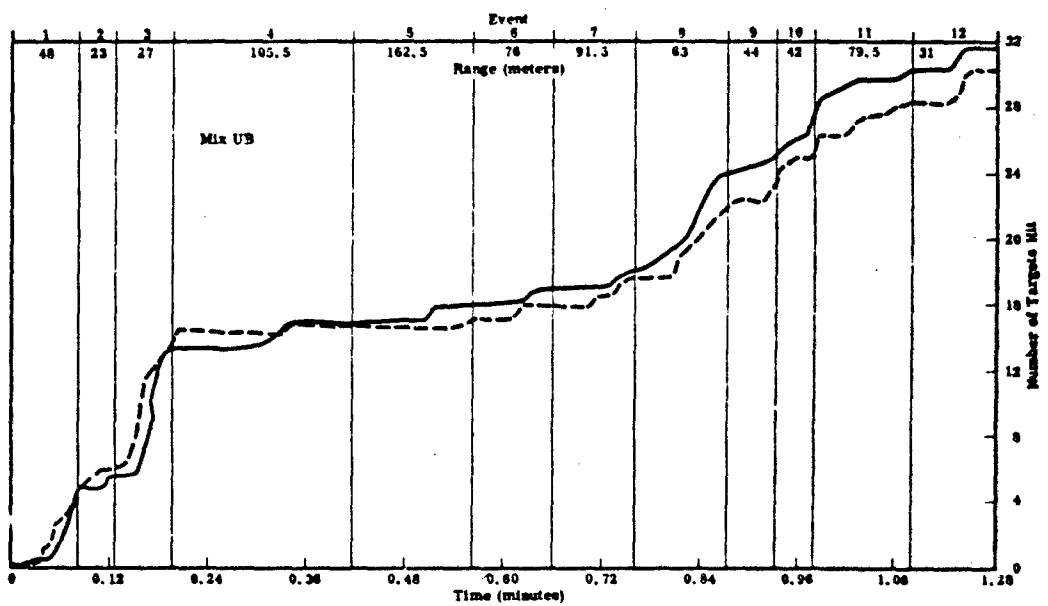
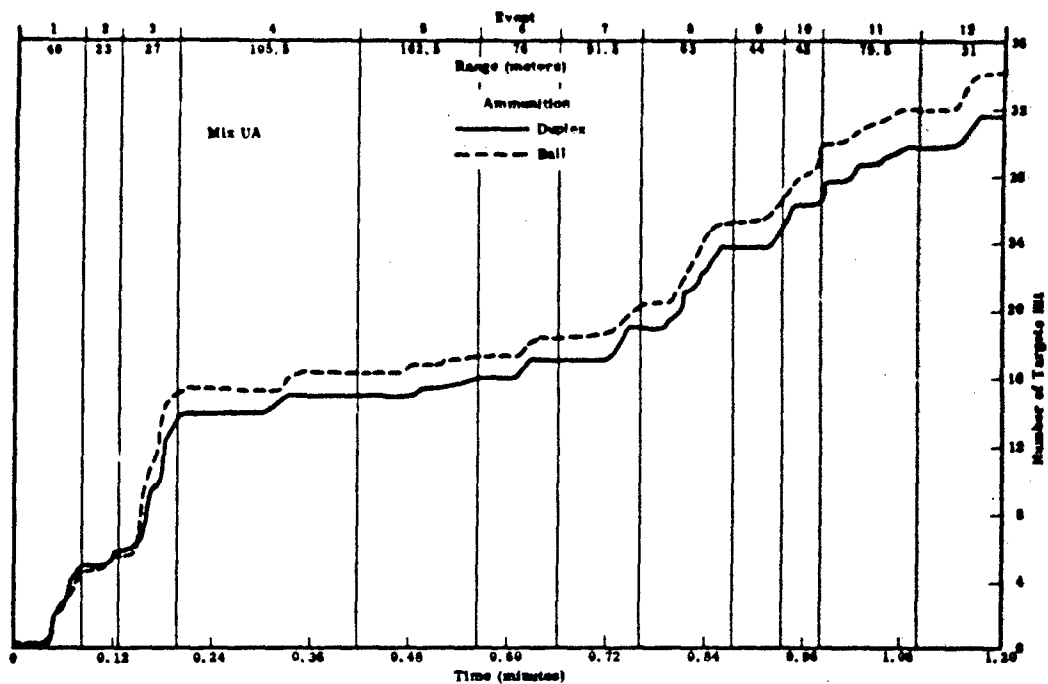

Figure 7-5

CUMULATIVE NUMBER OF TARGETS HIT--SITUATION 4

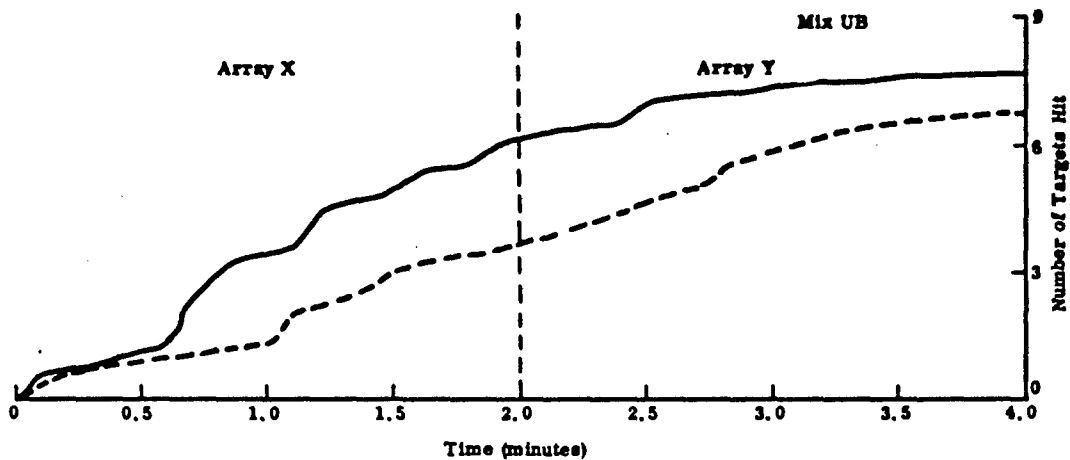
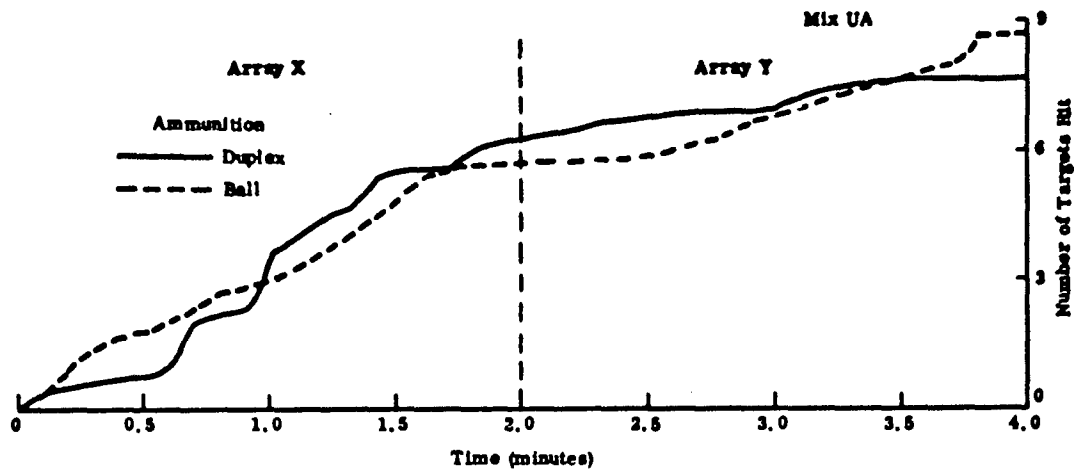

Figure 7-6  
CUMULATIVE NUMBER OF TARGETS HIT--SITUATION 5

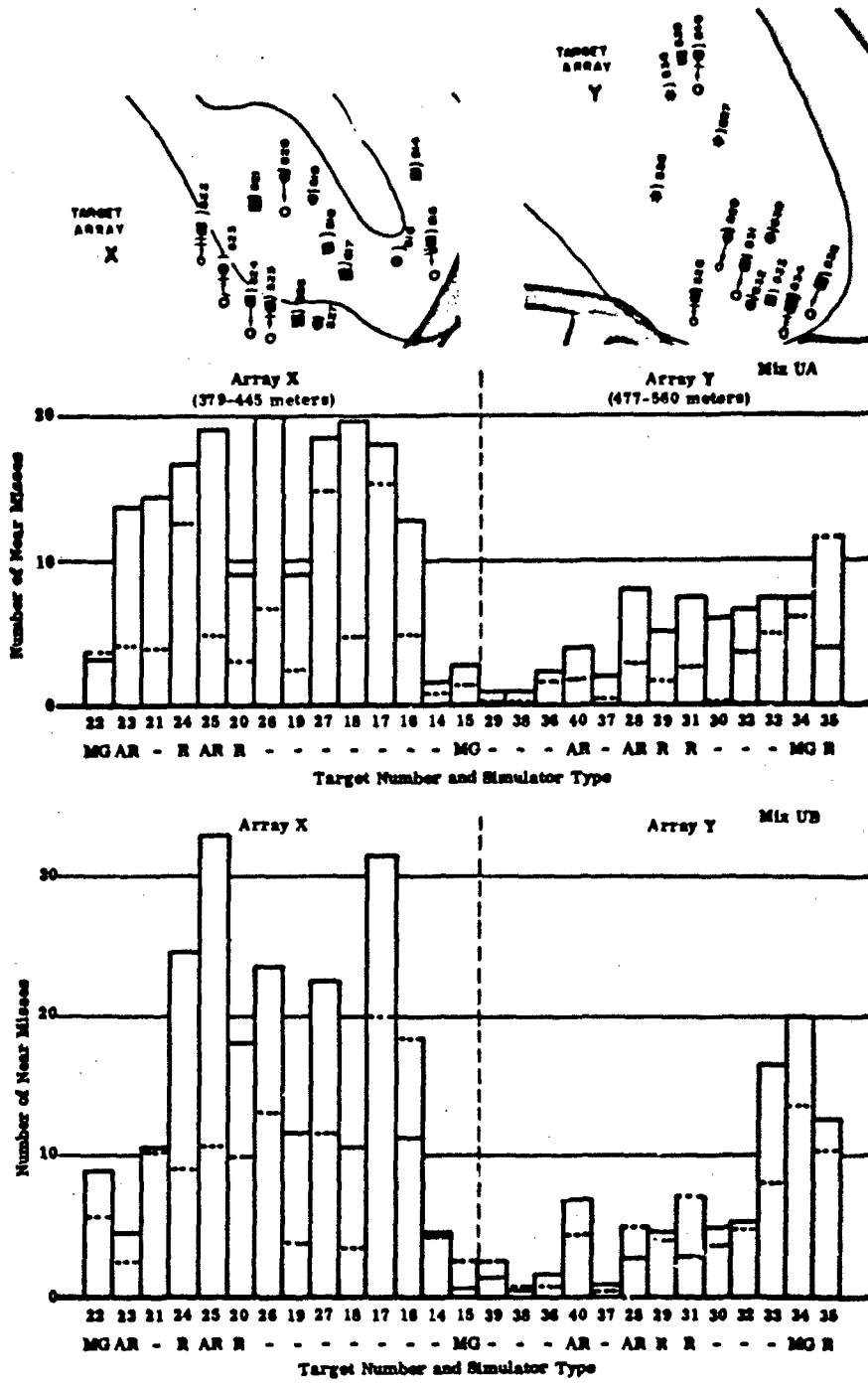

Figure 7-7  
 NUMBER AND DISTRIBUTION OF NEAR MISSES--  
 SITUATION 5



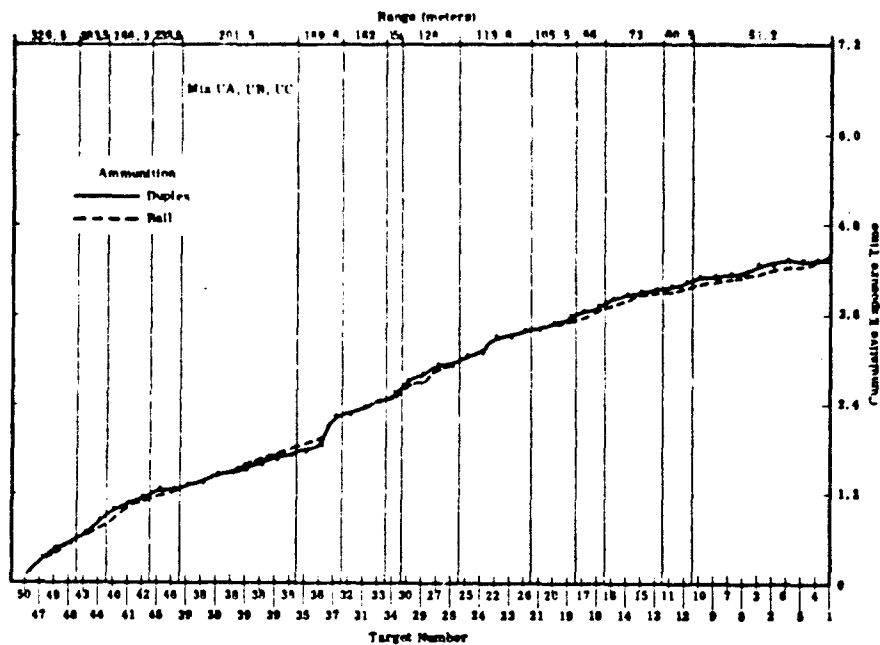

Figure 7-8 CUMULATIVE EXPOSURE TIME--SITUATION 7

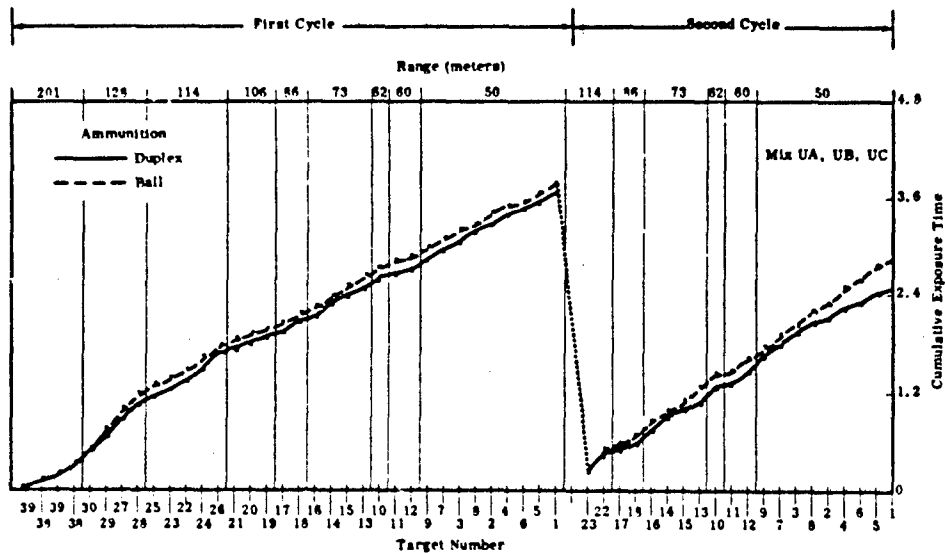

Figure 7-9 CUMULATIVE EXPOSURE TIME--SITUATION 8

It would be expected that as more duplex rounds were fired, an increase in target effects would be achieved, even if duplex had not been used. This could have been expected as a result of the greater number of rounds fired; however, although that might have accounted for the increases in the number of targets hit and the lower CETs, it was not great enough to account for the consistent superiority in both number of near misses and the total number of hits per target.

The use of duplex ammunition cannot be considered detrimental when used with the rifle in any situation at ranges between 15 and 545 meters. Moreover, duplex provided marked advantages under some circumstances, particularly in the area of number of near misses as an index of suppressive effect and distribution of fire. Within the framework of the USACDCEC experiment, it is concluded that duplex ammunition does not significantly decrease effectiveness under any circumstances, and under some circumstances, it increases effectiveness.

In Table 7-3, the expected duplex scores for the M14 rifle squads (UA and UB) are compared to the top ranking mix in each of the six rifle situations. The better score in each case is indicated by an asterisk.

The concept of duplex ammunition applies equally to both 7.62mm and 5.56mm ammunition. The increase in target effects achieved with 7.62mm duplex ammunition cannot be interpreted as a rationale for a choice of 7.62mm weapons over 5.56mm. Any advantages accruing to 7.62mm weapons from the use of duplex must also be attributed to 5.56mm weapons with duplex. Although not specifically tested in the experiment, 5.56mm duplex ammunition has been satisfactorily produced and tested in earlier laboratory and field experimentation by the Operations Research Office.<sup>1</sup> This ammunition weighs only about half that of 7.62mm duplex ammunition. Because current 5.56mm weapons are also lighter than 7.62mm weapons, an additional weight advantage is obtained. This combined weight advantage allows the soldier to carry up to three times as much 5.56mm ball ammunition as 7.62mm duplex ammunition for the same rifle system weight (Colt rifle versus M14).

Analysis shows that although the effects per round of ammunition are greater for 7.62mm duplex than for 5.56mm ball ammunition under certain circumstances, the effects per pound of ammunition are always significantly greater for 5.56mm ball than for 7.62mm duplex. Although duplex ammunition provided some advantages, greater advantages are considered possible, for it is believed that the duplex ammunition provided to USACDCEC did not meet all military ammunition requirement standards and that better quality control could have been exercised.

<sup>1</sup> Operations Research Office, SALVO II Rifle Experiment Preliminary Results (U), Johns Hopkins University, March 1958. CONFIDENTIAL

Table 7-3  
 EXPECTED DUPLEX SCORES COMPARED WITH  
 TOP RANKED RIFLE MIXES  
 (Rifle Duplex Experiment)

Effectiveness Measures	Best Mix and Raw Score (first firing)	UA Expected Duplex Score	UB Expected Duplex Score
Situation 1 - Rifle Squad in Live Assault			
CET (min.)	UB 24.1*	27.0	25.6
Near Misses	SC 499.6*	438.0	458.0
Sustainability	CA 72.2*	61.2	58.2
Targets Hit	UB 5.1*	3.4	4.4
Total Hits	SB 5.2*	3.5	4.5
Situation 2 - Rifle Squad as Base of Fire Supporting the Assault			
CET (min.)	UA 77.5	72.0*	72.8
Near Misses	CB 345.0	345.0	420.2*
Sustainability	CA 50.5*	23.0	13.0
Targets Hit	UA 10.7	14.4*	14.0
Total Hits	UA 12.6	19.8*	16.4
Situation 4 - Rifle Squad in Approach to Contact			
CET (min.)	SC 1.95*	1.99	2.03
Near Misses	-- --	--	--
Sustainability	CB 80.8*	65.1	59.1
Targets Hit	SC 30.8*	27.5	28.3
Total Hits	SC 53.8	87.1*	79.1

\* Better score

Note: Although Mix UB was in first place in Situation 1 in CET and Targets Hit when using ball ammunition, its expected duplex scores result in a drop to 7th and 4th place, respectively.

**Table 7-3**  
**EXPECTED DUPLEX SCORES COMPARED WITH**  
**TOP RANKED RIFLE MIXES**  
**(Rifle Duplex Experiment) (Concluded)**

Effectiveness Measures	Best Mix and Raw Score (first firing)	UA Expected Duplex Score	UB Expected Duplex Score
<b>Situation 5 - Rifle Squad as Base of Fire Supporting the Advance</b>			
CET (min.)	CB 38.6*	40.0	42.0
Near Misses	SA 207.3	207.5*	151.9
Sustainability	CA 84.8*	52.5	49.5
Targets Hit	SA 8.9*	7.6	5.8
Total Hits	SA 10.2*	7.6	5.8
<b>Situation 7 - Rifle Squad in Defense Against Attack</b>			
CET (min.)	CB 4.15*	5.0	6.2
Near Misses	-- --	--	--
Sustainability	CB 94.8*	61.5	41.1
Targets Hit	SB 56.0*	49.0	48.2
Total Hits	CB 90.5	92.0	100.6*
<b>Situation 8 - Rifle Squad in Night Defense</b>			
CET (min.)	SB 6.0	6.4	6.0
Near Misses	-- --	--	--
Sustainability	CB 69.4*	35.3	37.3
Targets Hit	CB 25.5*	18.3	22.3
Total Hits	SC 38.0*	29.0	32.8

Further immediate experimentation with duplex ammunition, particularly 5.56mm, is considered necessary.

#### B. AUTOMATIC RIFLE DUPLEX AMMUNITION EXPERIMENT

Mix UD (nine M14E2 rifles) was also fired in the duplex experiment. Three squads of the mix fired duplex ammunition and the other three fired ball as a control. All weapons fired two-round bursts, and the weapons in the automatic rifle positions (2 and 8 in Situation 1; 3 and 7 in Situations 2, 4 and 5; 4 and 7 in Situations 7 and 8) fired a mixture of half tracer and half ball ammunition in both the duplex squads and control squads. Results, presented in the same format as for the rifle duplex experiment, are given in tables for raw scores and expected scores (Tables 7-4 and 7-5).

Duplex provided a marked advantage in the assault and approach to contact -- (the two moving situations when the weapon was fired in shoulder pointed unaimed fire). In Situation 7 (aimed fire at point targets) duplex provided a tactically significant increase in the number of hits on targets that were hit. Although duplex provided an advantage in some situations, the numerical results of the firing in other situations (for example, Situation 5) indicated that ball ammunition is superior in automatic fire at longer ranges. The sample size, however, was small (three squads per group), and the variability of performance great. These differences may have occurred as the result of such chance factors as weather (Figures 7-10 through 7-12).

#### C. M60 MACHINEGUN DUPLEX AMMUNITION EXPERIMENT

The M60 bipod and tripod machinegun mixes that had originally fired during the September-December 1965 experimentation period fired each of the three machinegun situations again in January 1966. At that time, half of each mix fired ball ammunition and the other half duplex. Both halves used a mixture of one tracer to four rounds of nontracer ammunition.

Results are presented below in two tables. Table 7-6 presents the raw scores of the duplex squad compared to the control squads firing ball ammunition. Scores are given for squads using bipod machineguns (UE) and squads using tripod machineguns (UF) for each of the three machinegun situations (Situation 3, fire support of the assault; Situation 6, fire support of the advance; Situation 9, defense against attack). These raw scores represent small sample sizes (three squads) and the scores obtained after having already fired the various situations previously. To reduce the effects of inherent squad variabilities and put the scores in a format that would give the best estimate of what scores would have been obtained by all squads of the mixes if they had fired duplex instead of ball on their first firing in each situation, the scores were mathematically adjusted to eliminate the effects of learning and squad proficiency

**Table 7-4**  
**RAW SCORE RESULTS**  
**(Automatic Rifle Duplex Experiment)**

Effectiveness Measures	Ammunition				t	p
	Duplex		Ball			
	$\bar{X}$	SD	$\bar{X}$	SD		
<b>Situation 1 - Rifle Squad in Line Assault</b>						
CET (min.)	24.73	2.12	26.07	0.60	1.06	0.18
Near Misses	562.67	53.38	288.00	95.14	4.36	.006
Sustainability	72.67	6.27	65.93	4.06	1.56	.10
Targets Hit	5.29	0.64	2.83	1.93	2.10	.05
Total Hits	5.66	1.28	2.83	1.93	2.12	.05
<b>Situation 2 - Rifle Squad as Base of Fire Supporting the Assault</b>						
CET (min.)	77.06	1.01	82.09	6.43	1.34	.13
Near Misses	258.3	36.68	250.17	13.01	0.34	.38
Sustainability	7.23	7.07	11.73	7.80	0.74	.23
Targets Hit	11.33	1.15	9.33	2.31	1.34	.13
Total Hits	11.33	1.15	9.33	2.31	1.34	.13
<b>Situation 4 - Rifle Squad in Approach to Contact</b>						
CET (min.)	1.82	0.093	1.87	0.11	0.62	.29
Near Misses	--	--	--	--	--	--
Sustainability	21.10	24.13	20.40	27.0	.03	> .40
Targets Hit	33.33	1.15	30.33	1.5	2.71	.03
Total Hits	69.00	6.24	43.67	1.2	6.91	.002

**Table 7-4**  
**RAW SCORE RESULTS**  
**(Automatic Rifle Duplex Experiment) (Concluded)**

Effectiveness Measures	Ammunition				t	p
	Duplex		Ball			
	$\bar{X}$	SD	$\bar{X}$	SD		
<b>Situation 5 - Rifle Squad as a Base of Fire Supporting the Advance</b>						
CET (min.)	38.50	8.44	37.80	2.6	0.137	> .40
Near Misses	141.67	107.39	173.33	40.8	0.477	.33
Sustainability	47.60	4.16	56.57	6.8	1.949	.07
Targets Hit	7.33	4.58	7.67	4.2	0.467	.33
Total Hits	7.33	5.13	8.67	4.2	0.351	.37
<b>Situation 7 - Rifle Squad in Defense Against Attack</b>						
CET (min.)	5.2	1.1	5.3	.4	.37	.37
Near Misses	--	--	--	--	--	--
Sustainability	65.6	1.0	61.0	5.5	1.44	.11
Targets Hit	50.8	2.4	48.7	4.2	.78	.21
Total Hits	99.8	12.8	77.8	3.5	2.86	.02
<b>Situation 8 - Rifle Squad in Night Defense Against Attack</b>						
CET (min.)	6.6	.34	6.73	.59	.37	.37
Near Misses	--	--	--	--	--	--
Sustainability	1.0	1.7	4.0	3.6	1.30	.13
Targets Hit	14.7	1.5	15.0	3.0	.17	> .40
Total Hits	30.3	4.9	27.7	6.8	.55	0.31

**Table 7-5  
 EXPECTED DUPLEX SCORES  
 (Automatic Rifle Duplex Experiment)**

<b>Effectiveness Measures</b>	<b>Original Ball Ammunition Score (UD)</b>	<b>Expected Duplex Score</b>
<b>Situation 1 - Rifle Squad in Live Assault</b>		
CET (min.)	25.5	22.5
Near Misses	203.3	402.5
Sustainability	43.4	59.4
Targets Hit	2.9	7.5
Total Hits	2.9	7.5
<b>Situation 2 - Rifle Squad as Base of Fire Supporting the Assault</b>		
CET (min.)	78.6	75.4
Near Misses	272.0	227.1
Sustainability	7.8	25.9
Targets Hit	8.8	7.6
Total Hits	9.5	7.8
<b>Situation 4 - Rifle Squad in Approach to Contact</b>		
CET (min.)	2.1	1.9
Near Misses	--	--
Sustainability	42.0	46.2
Targets Hit	27.8	34.9
Total Hits	38.6	76.3



**Table 7-5**  
**EXPECTED DUPLEX SCORES**  
 (Automatic Rifle Duplex Experiment) (Concluded)

<b>Effectiveness Measures</b>	<b>Original Ball Ammunition Score (UD)</b>	<b>Expected Duplex Score</b>
<b>Situation 5 - Rifle Squad as Base of Fire Supporting the Advance</b>		
CET (min.)	40.3	43.7
Near Misses	125.5	83.5
Sustainability	52.1	43.8
Targets Hit	6.5	4.2
Total Hits	6.7	4.2
<b>Situation 7 - Rifle Squad in Defense Against Attack</b>		
CET (min.)	6.8	8.0
Near Misses	--	--
Sustainability	43.1	37.5
Targets Hit	44.9	42.7
Total Hits	70.2	80.9
<b>Situation 8 - Rifle Squad in Night Defense Against Attack</b>		
CET (min.)	7.6	7.8
Near Misses	--	--
Sustainability	38.1	32.1
Targets Hit	15.3	8.3
Total Hits	19.2	16.7

Table 7-6  
 RAW SCORE RESULTS  
 (Machinegun Duplex Experiment)

Effectiveness Measures	Ammunition				t	p
	Duplex		Ball			
	$\bar{X}$	SD	$\bar{X}$	SD		
<b>Situation 3 - Fire Support of Assault Mix UE, M60 Bipod Machinegun</b>						
CET (min.)	80.90	6.40	94.36	3.07	3.284	.017
Near Misses	352.0	53.36	249.7	36.12	2.751	.026
Sustainability	41.45	8.09	50.70	17.45	0.833	.227
Targets Hit	9.33	0.579	4.67	2.08	3.738	.010
Total Hits	10.67	0.579	4.67	2.08	4.813	.005
<b>Mix UF, M60 Tripod Machinegun (with T&amp;E mechanism)</b>						
CET (min.)	83.79	4.50	95.42	5.73	2.765	.025
Near Misses	371.3	78.47	324.3	51.21	0.864	.218
Sustainability	50.20	13.50	27.16	7.39	2.593	.032
Targets Hit	9.67	3.11	3.67	2.08	2.778	.025
Total Hits	12.33	2.58	4.33	3.21	3.365	.016
<b>Situation 6 - Fire Support of the Advance Mix UE - M60 Bipod Machinegun</b>						
CET (min.)	58.67	2.00	59.69	5.30	0.311	.387
Near Misses	307.33	68.30	270.33	102.08	0.522	.316
Sustainability	69.43	15.06	65.93	12.47	0.310	.387
Targets Hit	11.67	3.79	10.35	3.06	0.475	.332
Total Hits	12.33	4.04	12.33	3.06	0.000	>.40

**Table 7-6  
RAW SCORE RESULTS  
(Machinegun Duplex Experiment) (Concluded)**

Effectiveness Measures	Ammunition				t	p
	Duplex		Ball			
	$\bar{X}$	SD	$\bar{X}$	SD		
<b>Situation 6 - Mix UF, M60 Tripod Machinegun (no T&amp;E mechanism)</b>						
CET (min.)	62.94	2.11	59.77	1.72	2.018	.060
Near Misses	240.67	48.81	325.33	94.32	1.381	.122
Sustainability	66.83	1.45	60.20	10.25	1.110	.166
Targets Hit	6.00	3.00	13.33	4.93	2.20	.047
Total Hits	6.67	2.52	14.67	7.23	1.809	.027
<b>Situation 9 - Defense Against Attack Mix UE, M60 Bipod Machinegun</b>						
CET (min.)	8.36	1.24	8.75	1.22	0.388	.361
Near Misses	--	--	--	--	--	--
Sustainability	79.8	2.79	88.6	1.74	4.635	.005
Targets Hit	42.33	1.39	38.67	5.51	1.116	.165
Total Hits	83.67	6.11	61.33	14.47	2.463	.037
<b>Mix UF, M60 Tripod Machinegun (no T&amp;E mechanism)</b>						
CET (min.)	7.52	0.51	7.45	0.35	0.196	>.400
Near Misses	--	--	--	--	--	--
Sustainability	79.2	4.31	84.2	3.44	1.570	.097
Targets Hit	43.00	1.00	45.00	3.46	0.962	.196
Total Hits	91.33	13.58	63.67	8.39	3.002	.022

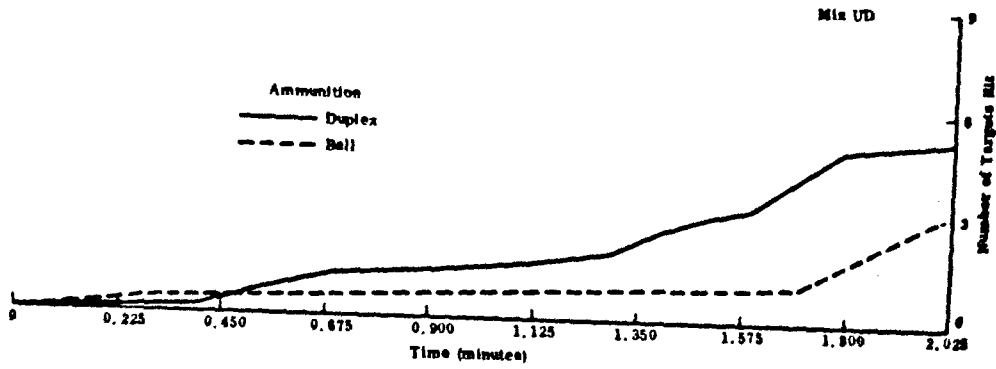

Situation 1

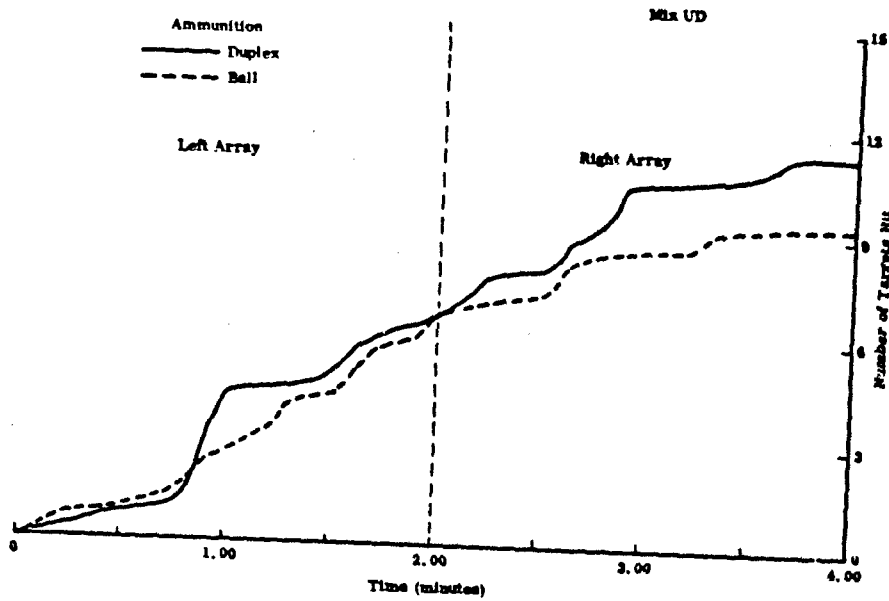

Situation 2

Figure 7-10 CUMULATIVE NUMBER OF TARGETS HIT

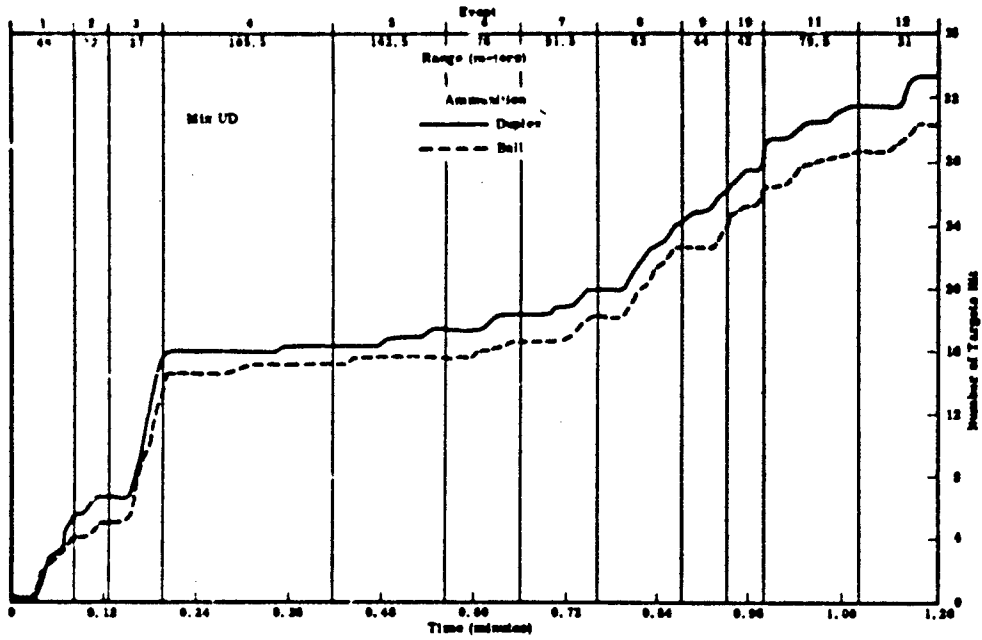

Situation 4

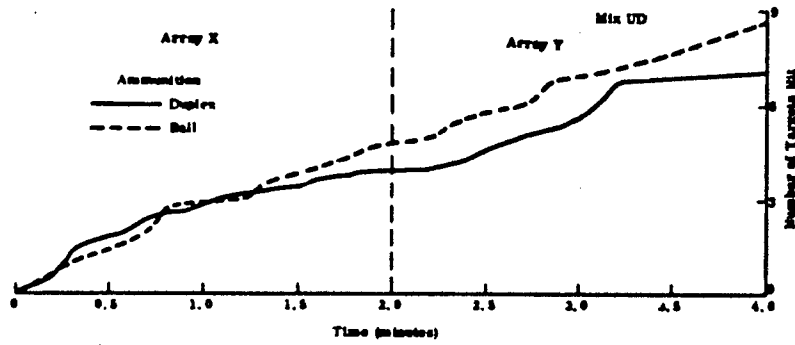

Situation 5

Figure 7-10 (Concluded)  
 CUMULATIVE NUMBER OF TARGETS HIT

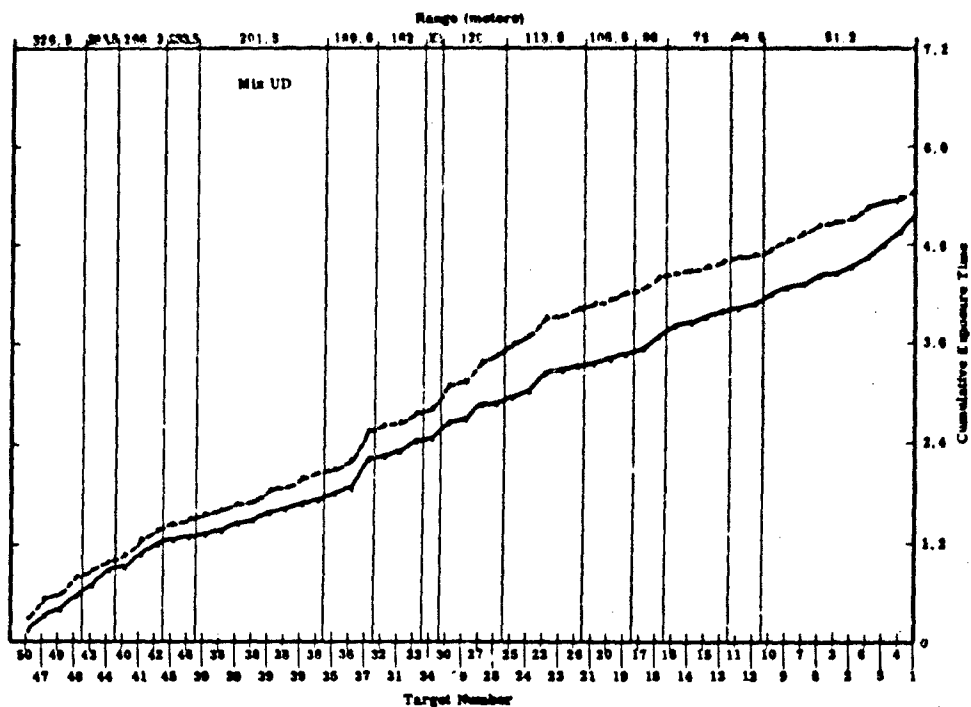

Situation 7

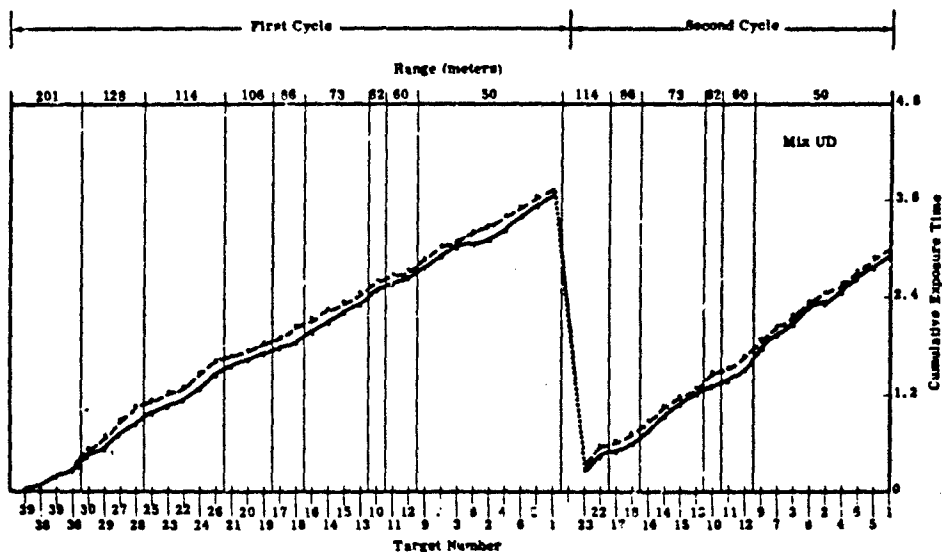

Situation 8

Figure 7-11 CUMULATIVE EXPOSURE TIME

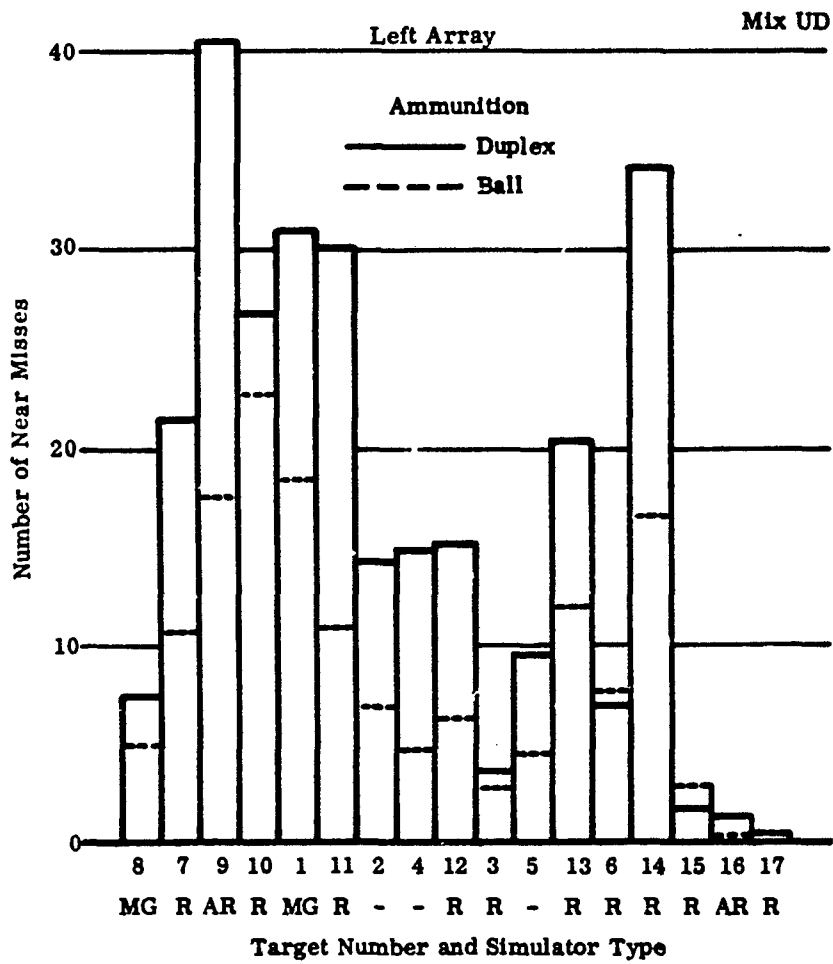
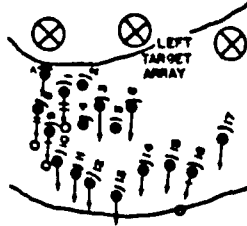

Figure 7-12  
NUMBER AND DISTRIBUTION OF NEAR MISSES--SITUATION 1

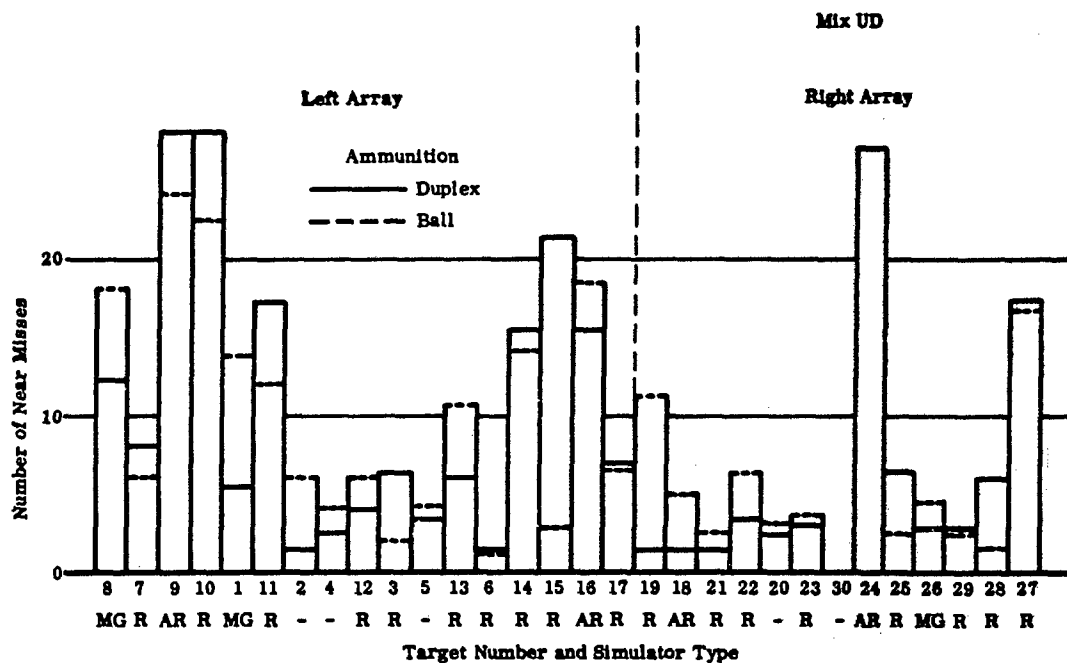
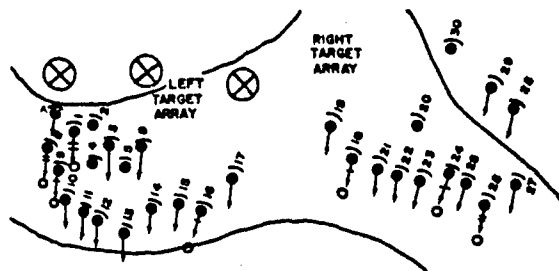

Figure 7-12 (Continued)  
 NUMBER AND DISTRIBUTION OF NEAR MISSES--SITUATION 2



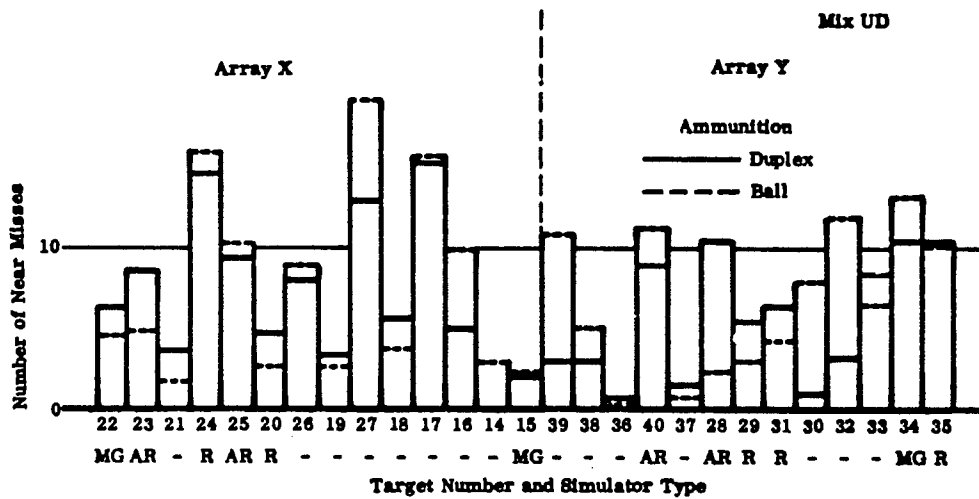
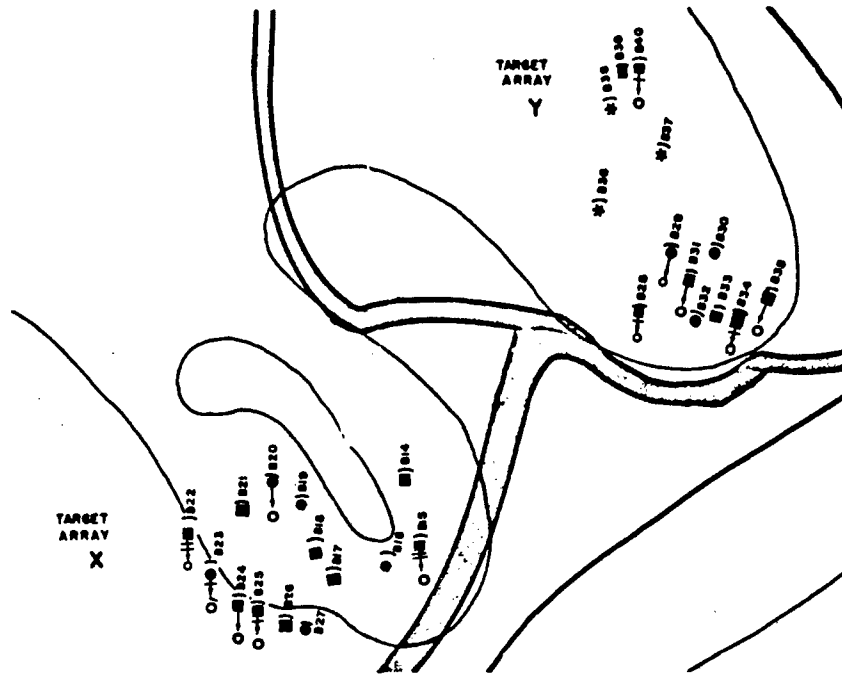

Figure 7-12 (Concluded)  
 NUMBER AND DISTRIBUTION OF NEAR MISSES--SITUATION 5

variable (expected duplex scores). These results are the most meaningful, precise, and valid of the two sets. However, the results and conclusions drawn from them prove almost identical, regardless of the set (raw scores or adjusted scores) used. Distribution of hits and near misses (not adjusted) are also provided (Figures 7-13 through 7-15).

Table 7-7 shows expected duplex scores. These are the scores that would have been expected if the machinegun squads had fired duplex instead of ball ammunition during their first firing of the various situations. The first firing scores were adjusted by applying mathematical corrections derived from the first and second firing scores of all six squads of the mix (squads firing duplex and squads firing ball). These expected duplex scores are directly comparable and each represents the contribution of all six machinegun squads of each mix.

In Table 7-6, the probability values (p) have been computed using a two-sample t-statistic. (See page 3-3 for explanation of probability values.)

In firing supporting fires at concealed and partially concealed targets (primarily distributed area fire) at a 300 meter range (Situation 3) duplex ammunition proved superior to ball ammunition for both bipod and tripod machineguns in target effects and overall effectiveness. While being fired at visible point targets (Situation 9) at ranges of 45 meters to 320 meters duplex ammunition proved superior to ball in target effects and overall effectiveness. Thus, the experimental results indicate that for both the bipod and tripod machineguns, at ranges out to 300 meters in both point fire and distributed area fire, duplex ammunition is superior to ball ammunition. However, at ranges of 450 meters to 750 meters (Situation 6) ball ammunition proved superior to duplex for both bipod and tripod machineguns firing primarily distributed area fire but with some aimed point fire whenever an actual target appeared.

Results indicate therefore that, for the machinegun, duplex ammunition is superior at ranges out to 300 meters while ball ammunition is superior at ranges beyond 450 meters. At an unknown point somewhere between 300 and 450 meters the effectiveness of ball ammunition for machineguns surpasses that of duplex.

**Table 7-7  
 EXPECTED DUPLEX SCORES  
 (Machinegun Duplex Experiment)**

<b>Effectiveness Measures</b>	<b>Original Ball Ammunition Score</b>	<b>Expected Duplex Score</b>
<b>Situation 3 - Fire Support of Assault Mix UE, M60 Bipod Machinegun</b>		
CET (min.)	92.6	82.83
Near Misses	246.4	277.18
Sustainability	51.2	42.11
Targets Hit	4.2	7.66
Total Hits	5.0	8.67
<b>Mix UF, M60 Tripod Machinegun (with T&amp;E mechanism)</b>		
CET (min.)	87.8	75.61
Near Misses	273.8	343.49
Sustainability	41.8	51.20
Targets Hit	6.8	21.85
Total Hits	7.8	22.30
<b>Situation 6 - Fire Support of the Advance Mix UE, M60 Bipod Machinegun</b>		
CET (min.)	63.6	65.56
Near Misses	228.0	220.64
Sustainability	78.5	82.31
Targets Hit	6.0	4.32
Total Hits	7.0	3.51

Table 7-7  
**EXPECTED DUPLEX SCORES**  
 (Machinegun Duplex Experiment) (Concluded)

Effectiveness Measures	Original Ball Ammunition Score	Expected Duplex Score
<b>Situation 6 - Mix UF, M60 Tripod Machinegun (no T&amp;E mechanism)</b>		
CET (min.)	56.5	52.91
Near Misses	308.2	261.05
Sustainability	65.5	66.91
Targets Hit	12.2	7.43
Total Hits	13.8	7.10
<b>Situation 9 - Defense Against Attack Mix UE, M60 Bipod Machinegun</b>		
CET (min.)	9.1	8.36
Near Misses	--	--
Sustainability	88.1	78.95
Targets Hit	39.5	43.67
Total Hits	65.1	78.27
<b>Mix UF, M60 Tripod Machinegun (no T&amp;E mechanism)</b>		
CET (min.)	8.0	7.21
Near Misses	--	--
Sustainability	79.9	82.74
Targets Hit	43.1	40.39
Total Hits	67.0	83.85

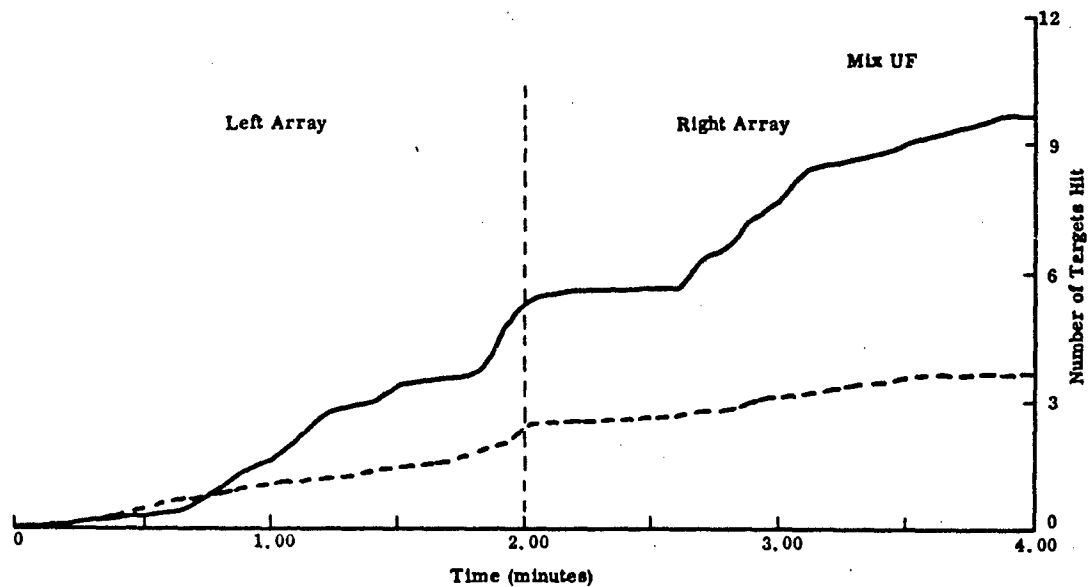
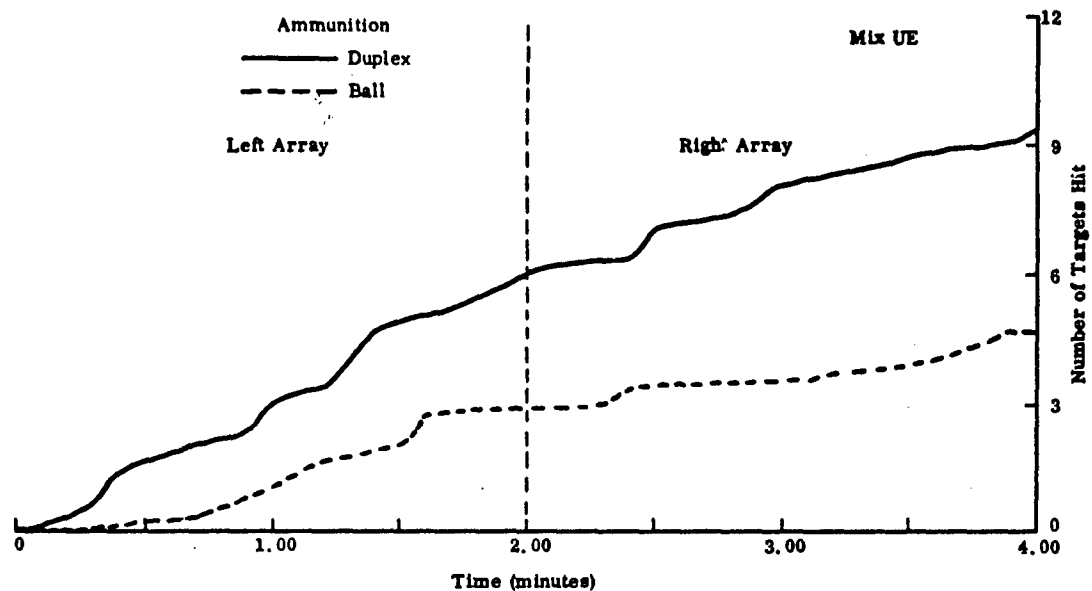

Figure 7-13  
CUMULATIVE NUMBER OF TARGETS HIT--SITUATION 3

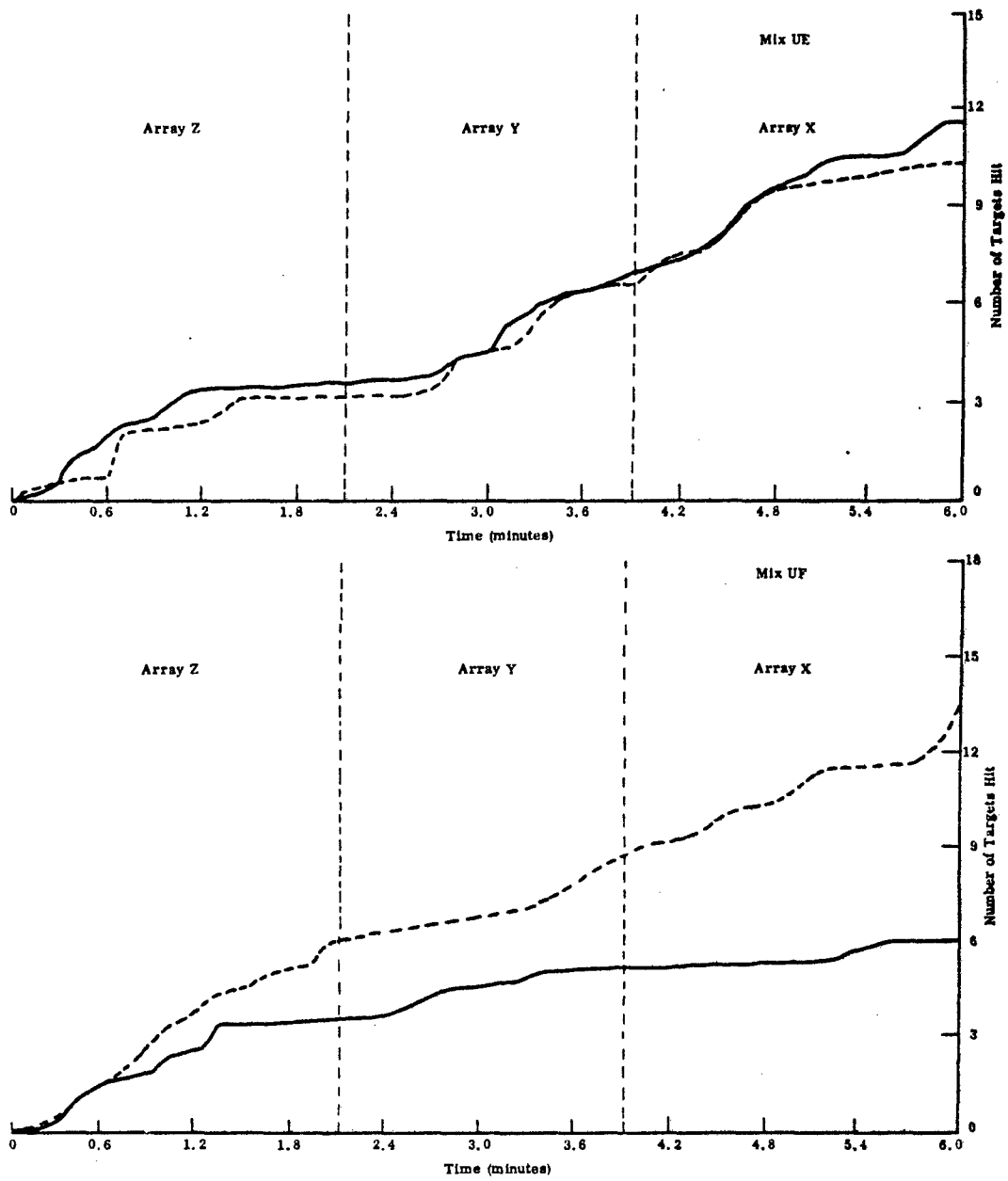

Figure 7-13 (Concluded)  
CUMULATIVE NUMBER OF TARGETS HIT--SITUATION 6

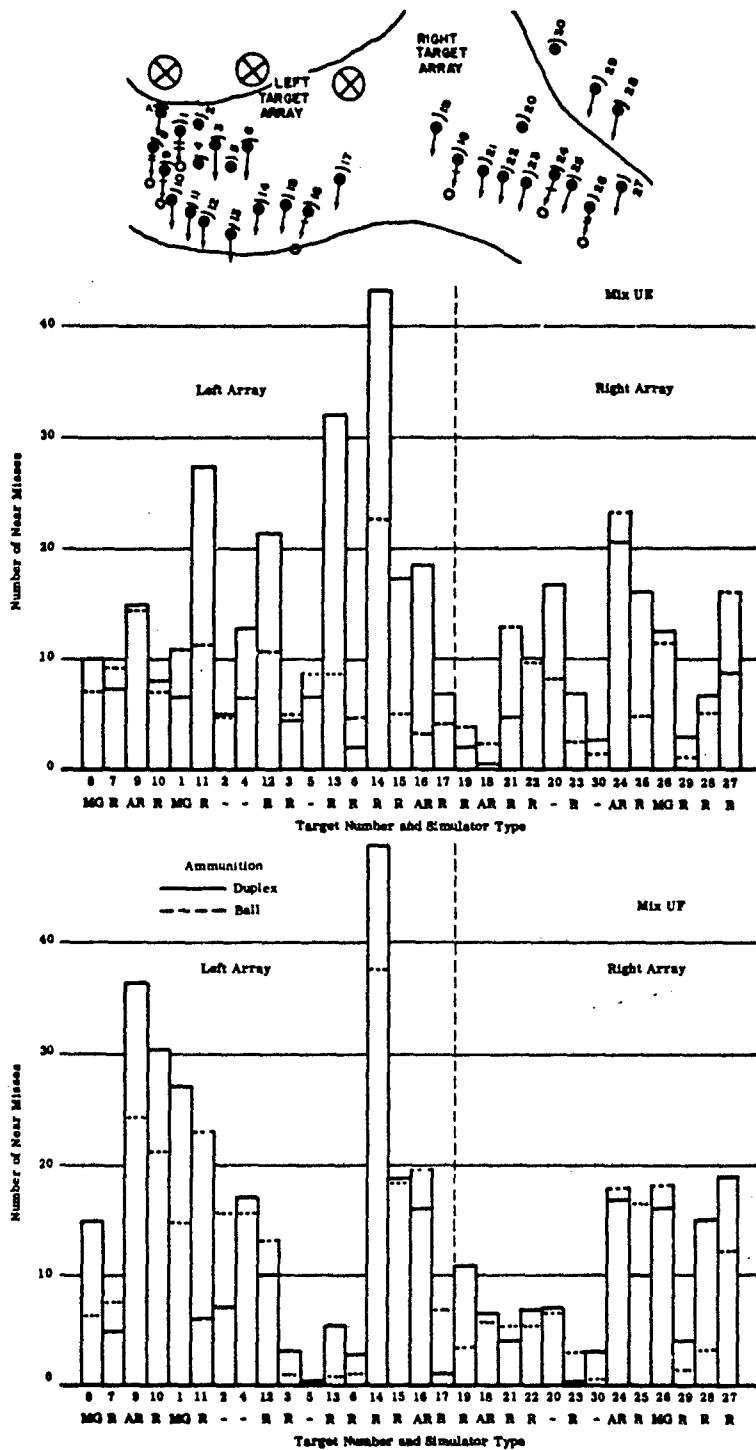
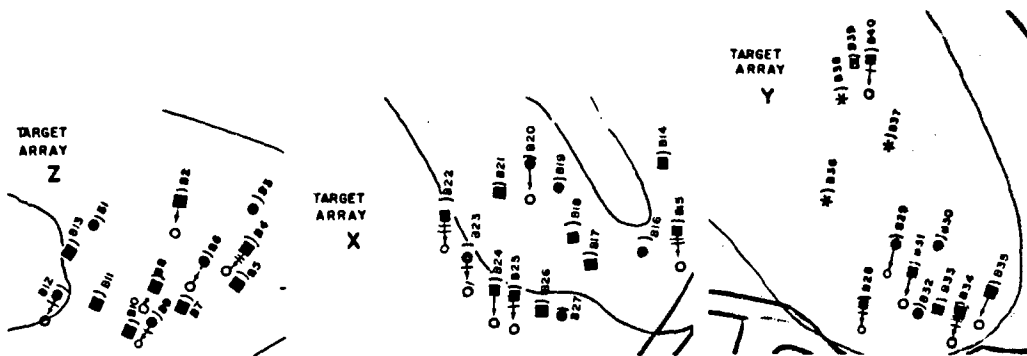

Figure 7-14 NUMBER AND DISTRIBUTION OF NEAR MISSES--SITUATION 3



Mix UE

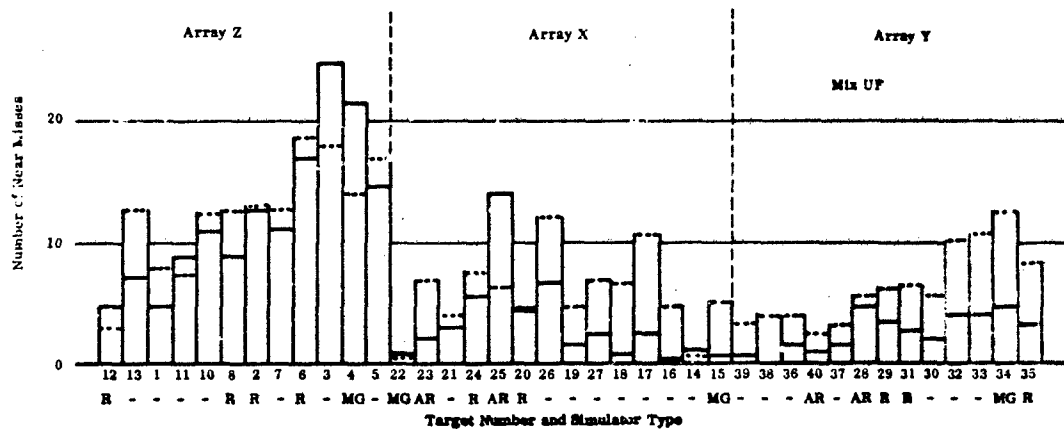
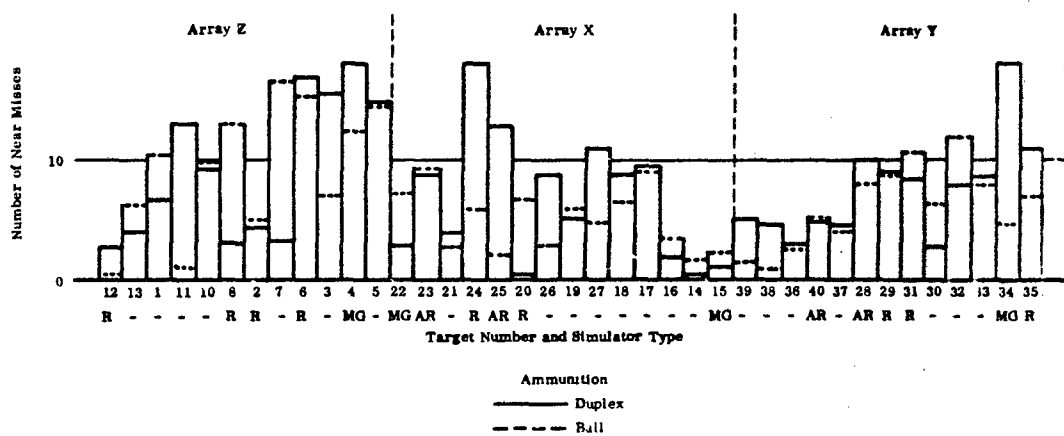

Figure 7-14 (Concluded)

NUMBER AND DISTRIBUTION OF NEAR MISSES--SITUATION 6



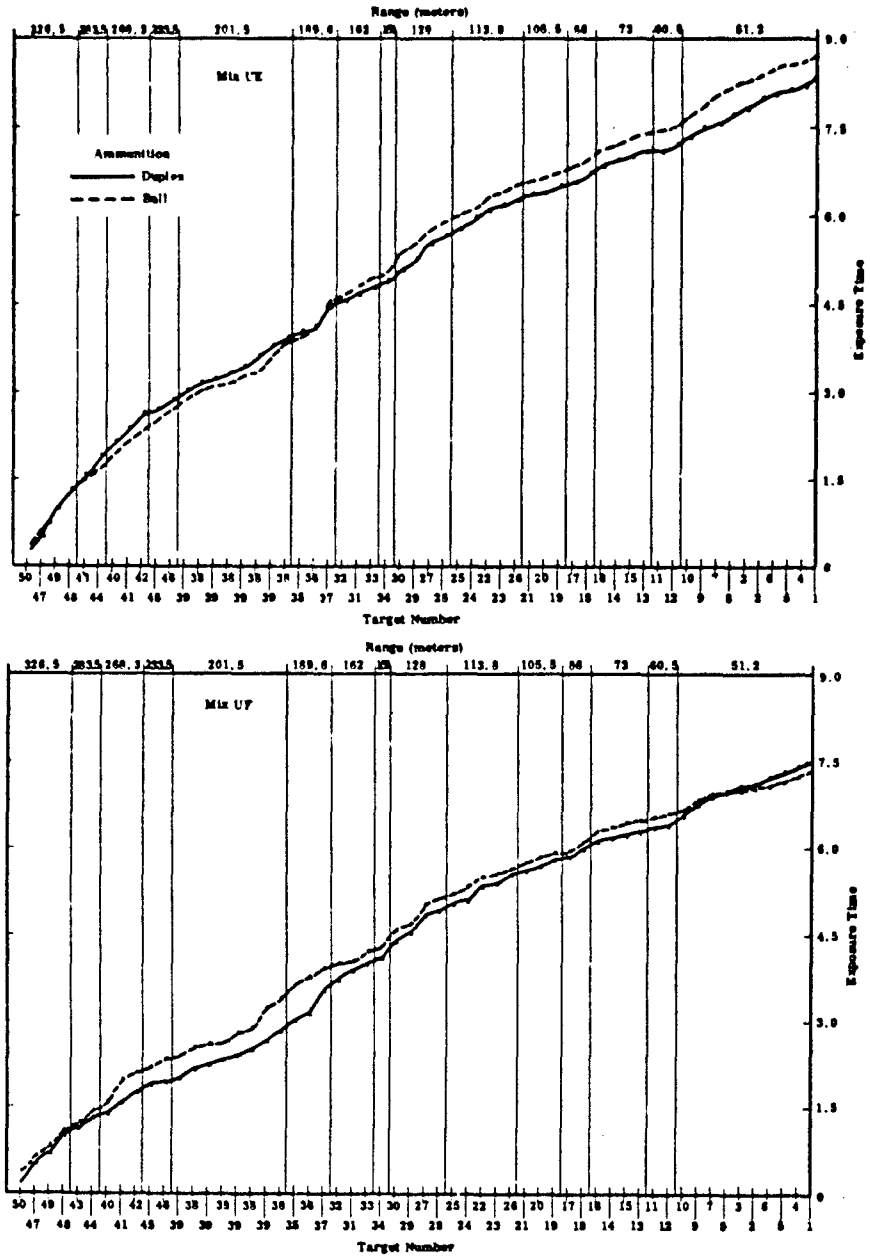

Figure 7-15  
 CUMULATIVE EXPOSURE TIME--SITUATION 9

## SECTION VIII

### LETHALITY DATA IMPLICATIONS

Pertinent lethality data were analyzed and studies performed. This included a review and analysis of the literature from 1928 to the present.

Current existing lethality data were carefully evaluated in relation to existing 5.56mm and 7.62mm ball ammunition and the candidate weapons used in the USACDCEC SAWS experiment. As a result of this analysis by a team of military and medical personnel and operations analysts, it is concluded that considerations of lethality support the USACDCEC conclusions presented in Section IX of this report.

A summary and analysis of the lethality data appears in Annex E, Small Arms Lethality.

**BLANK PAGE**

## SECTION IX

### CONCLUSIONS

These conclusions are derived from analyses of the results presented in Sections IV, V, VI, and VII. The terms "target effects," "sustainability," and "overall effectiveness" are used as defined and illustrated in Section II and III.

1. Rifle squads armed with low muzzle impulse weapons are markedly superior in overall effectiveness to rifle squads armed with high muzzle impulse weapons.
2. Rifle squads armed with Colt weapons and rifle squads armed with Stoner weapons are approximately equivalent in target effects achieved.
3. Because of the lighter system weight and related advantages in sustainability, rifle squads armed with Colt weapons are superior to squads armed with Stoner weapons.
4. Rifle squads equipped only with Colt automatic rifles appear superior to all other squads evaluated in overall effectiveness. Further testing of this hypothesis and evaluation should be undertaken.
5. The hypothesis that the most effective squad is a squad equipped with Colt rifles with XM148 grenade launchers attached (to provide a SPIW-type dual "area fire-point fire" capability) is promising and should undergo further testing.
6. Hypotheses that high muzzle impulse weapons are superior to low muzzle impulse weapons at longer ranges (300 to 550 meters) are not supported.
7. Hypotheses that lightweight rifles with high sights and straight stocks, such as the M16E1, are inferior or inadequate in pointing fire are not supported.
8. Low muzzle impulse weapons are superior to high muzzle impulse weapons in both automatic and semiautomatic fire in night firing in the defense.
9. A squad equipped only with M14 rifles is superior to a squad equipped with any other single US 7.62mm weapon, or combination of these weapons.

10. The M14E2 automatic rifle is unsatisfactory in overall effectiveness for use in the rifle role in the rifle squad.

11. It cannot be concluded that the low target effects of the AK47 rifle in the USACDCEC SAWS Field Experiment are indicative of the performance of the AK47 rifle in general.\*

12. The AK47 rifle (Soviet, East German and Chinese Communist) is significantly more reliable than any US 7.62mm or 5.56mm weapon.

13. The M60 machinegun is not suitable for use in the rifle squad because: 1) the system weight requires a two-man crew; 2) the sustainability of the weapon is marginal, even with a two-man crew; and 3) the size and weight of the weapon make it extremely difficult to manage in a moving firing situation.

14. The low muzzle impulse machinegun is a feasible weapon of incorporation into the rifle squad in the conventional automatic rifle role, or into a new squad organization context in the machinegun role.

15. The 5.56mm Stoner machinegun is judged to have a high reliability potential.

16. The standard 5.56mm ammunition provided for the experiment is not satisfactory because of fouling characteristics, the pressure mismatch of propellants in the ball and tracer cartridges, and primer sensitivity. These ammunition deficiencies are judged readily correctable.

17. The 5.56mm machinegun belt links provided for the experiment were not made to design specifications and are not satisfactory for use with the Stoner machinegun. This deficiency is readily correctable.

18. Neither the 7.62mm nor the 5.56mm tracer rounds are considered satisfactory for use by the firer in adjusting fire during daylight hours.

19. For aimed fire on visible point targets during daylight, semiautomatic fire is superior to automatic fire. This is true for all rifles, both low and high muzzle impulse. This does not imply, however, that automatic fire may not be superior in suppression effects and hits on adjacent concealed targets.

20. At ranges of less than 500 meters duplex ammunition under most circumstances provides a significant increase over simplex ball

\* The nine AK47 rifles used in the experiment were shared by all experimentation subjects. Amount of use of the weapons before the experiment was unknown, and a variety of types of foreign ammunition was used in the experiment.

ammunition in the number of targets hit, the number of total hits on targets that are hit, the timeliness of hits, and the number of near misses as an indication of suppression. Under no circumstances does its use significantly decrease effectiveness at ranges of less than 500 meters.

21. Duplex ammunition is most effective at close ranges with its advantage in effectiveness over simplex ammunition decreasing as range increases.

22. The concept of duplex ammunition applies equally to 7.62mm and 5.56mm ammunition.

23. Considerations of the relative lethality of 5.56mm and 7.62mm ammunition (with the possible exception of duplex) support all of the CDCEC SAWS conclusions. It is concluded that there are no tactically significant differences between 5.56mm and 7.62mm ammunition per round of ammunition; however, 5.56mm ammunition is significantly superior to 7.62mm ammunition in lethality per pound of ammunition or per basic load carried by the soldier.

END  
DATE  
FILMED  
11-7-66

# **EXHIBIT 3**



~~SECURITY INFORMATION~~  
~~SECRET~~  
Unclassified

## OPERATIONAL REQUIREMENTS FOR AN INFANTRY HAND WEAPON

### INTRODUCTION

The subject of this study is of a basic nature for it applies to the basic weapon of the basic branch—the rifle carried by the infantry. Because the hand arm offers certain capabilities not duplicated by any other means, and because it is basic to the whole weapons system, the effectiveness of that weapon in battle is a subject of first importance in any general consideration of the whole fire system. It follows that any study directed toward a comprehensive examination of the aggregate of weapons for the purpose of designing and proportioning a “balanced” system (the mission of Project BALANCE) may logically take a beginning with this basic ground weapon.

Such an approach is, moreover, timely at the moment in the sense that the NATO is confronted now by an urgent requirement for standardization of a general purpose hand weapon for the infantry. Thus, any information which may be cogently pertinent to such weapons will have a bearing on an immediate problem of some moment.

The study here presented has been carried out not only in full recognition of the importance of improving the effectiveness of infantry, but also in growing awareness that the task—even though so basic in nature—is an exceedingly complex one. The effort has thus far been only preliminary. Limited time, and inadequate knowledge of basic unit operations in combat, have restricted the degree to which the whole problem might be examined. Consequently, no complete solution is offered by this memorandum; rather, some analytical findings are presented, which suggest the principles governing certain measures which could be undertaken to improve infantry effectiveness with respect to aimed rifle fire.

This memorandum bears directly upon the importance and the use by infantry of aimed small arms fire in the front line

Unclassified

~~SECRET~~  
SECURITY INFORMATION  
#17724

Unclassified

tactical fire fight, but does not consider expressly the importance, the techniques or the effects of unaimed "covering fire" delivered by small arms. The reason for directing the study effort toward aimed fire is that the common arm of the infantry, the rifle, is designed primarily for the aimed fire role; that is, the weapon is designed expressly to afford a capability of directing missiles at observed man-targets with high inherent precision, in both offensive and defensive action. Delivery by such a weapon of covering fire to neutralize or pin down the enemy and permit friendly maneuver is tactically useful, but nonetheless amounts to a secondary role for which design has provided only incidentally. The important question at hand, therefore, is not so much connected with the varying actual use of the present firearm as with the need of the infantry to engage the close enemy effectively by the use of aimed rifle fire, and with the feasibility of incorporating in the rifle of general issue the capability of answering this real requirement.

Recent ORO investigations in Korea have shed some light on this subject by indicating quantitatively the comparative importance of aimed and unaimed fire as related to offensive and defensive operations. Generally, aimed fire plays a more important part in defense than unaimed or volume fire, whereas in the offensive, the reverse is true. Almost irrespective of the part played by the supporting weapons before or during the final phase of close combat, the decision in each small tactical battle rests ultimately in large measure with the infantryman and his ability to use his hand weapon effectively. If hand-to-hand fighting develops at all, decision thus rests almost entirely with the infantry in this last time-phase of the tactical situation. To attach importance to this aspect of battle is therefore logical, and the attempt to maximize the capability of infantry in this role cannot be misdirected effort.

The study has yielded suggestions for increasing infantry effectiveness by improving the effects of aimed rifle fire. It appears almost certain that future large-scale ground operations will involve a numerically superior enemy and necessitate, at first, a defensive strategy on our part. Moreover, frequent attempts to overrun infantry positions, with attendant close combat, are to be anticipated. Thus, to increase each infantryman's capability with respect to defensive rifle fire becomes highly desirable.

In the light of such considerations as these, it appears correct to assume that: 1) it is desirable to increase in both number and

Unclassified

# **EXHIBIT 4**

**M27 Infantry Automatic Rifle**  
5.56 mm x 45



The M27 Infantry Automatic Rifle is a variant of the HK416. The HK416 was originally developed by Heckler & Koch for U.S. special operations forces as a major product improvement of M4/M16-type carbines and rifles. Using the HK-proprietary gas piston system found on the company's G36 rifle, the HK416 prevents propellant gases and carbon from fouling the weapon's interior, making it the most reliable of any M4/M16 type weapon.

During the last decade, the HK416 has been combat-proven in Southwest Asia and has also gained the attention of military, law enforcement, and security users outside of the U.S. In April 2007, the HK416 was selected as the new Norwegian Army rifle.

The HK operating system, as well as other improvements made to various components and parts ensure reliability and performance in all scenarios, with all types of ammunition, with all barrel lengths, and with and without sound suppressors attached. An innovative free-floating four-quadrant rail system/handguard designed by HK allows all current accessories, sights, lights, and aimers used on M4/M16-type weapons to be fitted to the HK416. This HK rail system handguard can be installed and removed without tools.

The HK416 uses barrels produced by Heckler & Koch's famous cold hammer forging process. The highest quality steel is used in this unique manufacturing process producing a barrel that provides superior performance with minimal degradation of accuracy and muzzle velocity even after thousands of rounds are fired.

Many HK416 variants also have "OTB" (over-the-beach) features and can be safely fired after being submerged in water and not completely drained. In addition to the improvements in the baseline weapon, HK has produced corrosion resistant steel and polymer magazines and a proprietary buffer to further enhance functional reliability.

**M27 EQUIPPED OR INTEGRATED AT SERVICE LEVEL WITH:**

- KNIGHT'S ARMAMENT CO. 600 METER MICRO/BACKUP IRON SIGHTS
- BLUE FORCE GEAR SLING RAIL MOUNT & VCAS SLING
- AIM MANTA RAIL COVERS
- HARRIS LARUE TACTICAL BIPOD WITH QUICK DETACH OR GRIPOD
- U.S.-STYLE BLANK FIRING ADAPTOR (BFA)
- OPERATOR'S MANUAL
- OTIS CLEANING KIT
- U.S. GOVERNMENT 30-ROUND MAGAZINES (HK MAGAZINES OPTIONAL)
- TRIJICON SQUAD AUTOMATIC WEAPON DAY OPTIC (S.D.O.)
- USMC BAYONET

**TECHNICAL DATA**

NSN	1005-01-579-5325
Manufacturer	Heckler & Koch / HK416 variant
Caliber	5.56 NATO (.223 Caliber)
Length	33.5–37.5 inches
Weight	8.16 pounds (weapon only) Approximately 12.67 pounds (weapon, 30-round loaded magazine, accessories including: iron sights, SDO-optic, PEQ-16, VCAS sling, QD 9-13" bipod, vertical foregrip, and rail cover set)
Barrel	16.5 inches, cold hammer forged with bayonet lug
Rifling	1 in 7 inches, right-hand twist, 6 grooves
Sights	As assigned by USMC — Knights Armament Company 600 meter backup iron sights (BUIS)
Optic	As assigned by USMC — Trijicon S.D.O., 3.5 x 30 mm, 100 - 1,000 meter reticle with quick ranging feature and close range Ruggedized Miniature Reflex (RMR)
Rail system	1-piece quad (M1913 Picatinny) Free Floating Rail System / 11" length
Buttstock	6-position adjustable with storage space
Operation	Air-cooled, gas operated, short stroke piston driven operating rod, firing from a closed bolt
Selector	Safe, Semi, Automatic / Ambidextrous
Magazine	30-round U.S. government magazines (HK magazines optional)
Muzzle velocity	Approximately 2,900 FPS (with M855 ammunition)
Rates of Fire	Cyclic: Approximately 700-900 RPM Sustained: Approximately 36+ RPM Semi: Approximately 45 RPM Automatic: Approximately 90+ RPM (3-5 round burst)
Accuracy	Test guns with 15,000 rounds have fired 2 MOA with M855 ammunition
Single fire	Single fire: Less than 4 MOA (averages 2.5 MOA with M855 ammunition)
Automatic fire	Less than 8 MOA with 5-round burst (averages 5.5 MOA with M855 ammunition)
Graduated Range	Iron sight graduated effective range: 600 meters Optic graduated effective range: 1000 meters
Maximum range	Approximately 3,545 meters
Barrel life	15,000 rounds minimum
Parts life	10,000 rounds minimum
Other	Equipped with "Over the beach (O.T.B.)" features and other enhancements



# **EXHIBIT 2**

## **EXPERT WITNESS REBUTTAL REPORT OF JEFFREY EBY**

### **BACKGROUND/QUALIFICATIONS**

I, Jeffrey Eby, served in the United States Marine Corps from June of 1982 through November of 2010. I spent 17 years as an enlisted infantry Marine before receiving a Commission to Chief Warrant Officer-2 in February 1999. I retired as a Chief Warrant Officer-5, as the senior infantry weapons officer in the Marine Corps, serving under the Deputy Commandant for Plans Policies and Operations inside the Pentagon in November 2010. As an Infantry Weapons Officer, I served as an expert advisor at the Infantry Battalion level (900 Marines), Infantry Regimental Combat Team (10,000 Marines), as well as the advisor to the Deputy Commandant of Plans, Policies & Operations as the Infantry Advocate for all manning, training, and equipping efforts in support of the Marine Corps (175,000 Marines). During this time, I served in 4 combat deployments to Iraq for a total of 27 months. I was one of 44 infantry weapons officers among 175,000 Marines when I was commissioned in 1999, retiring as one of the 101 infantry weapons officers among 175,000 marines in November 2010. The growth of the infantry weapons officer program escalated in 2003 from 44 to 101 as operations Iraqi freedom and Enduring Freedom in Iraq and Afghanistan continued.

Marine Corps Infantry Weapons Officers, titled Marine Gunners, are considered the USMC's experts on small arms within ground combat. The job of the Marine Gunner is to train Marines on the care, cleaning, and employment of all individual and crew served weapons (2 rifles<sup>1</sup>, 3 sniper rifles, 2 grenade launchers, 4 different machine guns, 2 mortar systems, 4 rocket systems, 2 anti-tank missile systems, a 25mm bushmaster cannon, tank main gun capabilities, artillery capabilities, all associated day and night aiming systems, laser pointers and illuminators, as well as all breaching techniques using ballistic, mechanical or explosive methods) within the ground combat forces. Marine Gunners are tasked to develop training programs for weapons, both individually and in combination of systems, and then to advise commanders on the best selection and employment of various weapons systems that will cause the most effective opposition for our enemies.

### **ASSIGNMENT**

I have been asked by the Plaintiffs to respond to the reports from the State's expert witnesses, Phil Andrew and James Yurgealitis, to the extent they opine on the reasons that the U.S. Military selected the M-16 for use in military service and the purpose of semiautomatic rifle fire in combat. I base my opinions on my experience and background serving in the military described above and the documents cited herein that my military experience allows me to properly evaluate and interpret.

---

<sup>1</sup> The US Army Weapon Systems Handbook 2020-2021 [Weapon Systems Handbook 2020-2021 \(army.mil\)](#) does not use terms such as "service, assault, nor battle" when defining the basic issued rifle in the hands of combat units. The simple term 'rifle' is sufficient, as indicated within this reference on pages 142, 144, 180, 208, 209, 320, 354, 372, 376, 382, 388, 390.

## OPINIONS AND ANALYSIS

In paragraph 26 of his report, the State's expert witness, Mr. Phil Andrew, states that "the Army was so impressed with the killing potential of the AR-15 that it shipped 1,000 rifles to Vietnam for the South Vietnamese troops and their American special-force trainers in 1961 to test during live combat in the Vietnam War." Mr. Andrew bases his statement on a report from the Office of the Secretary of Defense. It is true that said report states that the Army shipped 1,000 AR-15 rifles to Vietnam; to be clear, the "AR-15" being discussed in that report is select-fire (not semiautomatic only), what would later be called an "M-16." Mr. Andrew, however, misstates the rationale for sending the AR-15 (M-16) to Vietnam initially.

It was not because the U.S. Army was so impressed with its supposed "killing potential." To the contrary, the Army resisted adoption of the AR-15 (M-16). From 1957 to 1959, the U.S. Air Force sought to replace their aging M1 Garands and M2 Carbines with the (select fire) AR-15, while the U.S. Army preferred the M14. The bickering between the two services led the Defense Department's Advanced Research Projects Agency (ARPA) to ask permission to test the (select fire) AR-15's effectiveness in the Republic of Vietnam. Over the U.S. Army's objections, Secretary of Defense McNamara granted ARPA approval to ship 1,000 (select fire) AR15s to Saigon for six months of field tests in the hands of Vietnamese soldiers.<sup>2</sup>

There is no evidence that the decision to do so was based on the (select fire) AR15's "killing potential." Rather, as the very report Mr. Andrew relies on in paragraph 26 explains, the AR-15 (M-16) was selected over other options, at least in part, because:

- a. The problem of selecting the most suitable basic weapon for the Vietnamese soldier is complicated by his small stature and light weight. The average soldier stands five feet tall and weighs ninety pounds.<sup>3</sup>
- b. It is easier to train the Vietnamese troops to use the AR-15 than the M1 Rifle, BAR, M1 Carbine, or the Sub-Machine Gun.<sup>4</sup>
- c. The AR-15's physical characteristics are well suited to the small stature of the Vietnamese soldier.<sup>5</sup>
- d. In automatic fire, the accuracy of the AR-15 is considered comparable to the Browning Automatic Rifle and Superior to the Sub-Machine Gun.<sup>6</sup>

---

<sup>2</sup> See **Exhibit 1**, MARKSMANSHIP, MCNAMARA AND THE M16 RIFLE: ORGANIZATIONS, ANALYSIS AND WEAPONS ACQUISITION. Thomas L. McNaugher, March 1979, The Rand Corporation, Santa Monica, CA 90406, page 30

<sup>3</sup> Field Test Report, AR-15 Armalite Rifle dtd 20 Aug 1962 (Entered as Exhibit B by State Witness Mr. Phil Andrew), page 2, paragraph 4.a

<sup>4</sup> Ibid, page 4, para b. 2.a.

<sup>5</sup> Ibid, page 4, para b.2.b.

<sup>6</sup> Ibid, page 4, para b.2.h.

In sum, the evidence shows that the U.S. Army resisted adoption of the AR-15 (M-16) and that it was sent to Vietnam for testing because it was considered optimal for the average small-statured South Vietnamese soldier, being a low-impulse, lightweight rifle that was relatively accurate, and to resolve a dispute between military branches over the rifle's utility in combat.

Mr. Andrew's statement in paragraph 27 about the Army ultimately adopting the AR-15 (M-16) based on accounts of its performance in the field accurately describes the Office of the Secretary of Defense's report that he relies on, as do the accounts of wounds recorded in the field related in paragraphs 28-31 of his report. However, the Office of the Secretary of Defense's 1962 report itself is what is unreliable.

Note that the report is the result of "a comprehensive field evaluation under combat conditions in Vietnam." In other words, it was based on anecdotal statements from soldiers' experience in real combat, not a controlled experimental environment. Accurate measurement of wound ballistics in this manner is virtually impossible. I personally spent 27 months in war zones of Iraq (1991 in Northern Iraq and 2003-2005 from Kuwait to Baghdad initial assault, then 15 months in the western parts of Iraq, including the November 2004 assault through the urban fight of Fallujah). Yet, I have no medical training, nor forensic training that would allow me to look at a battlefield casualty and determine the type of bullet, explosive munition, or other projectile that caused a wound on human bodies. Nor would the typical infantryman like the ones whose observations appear in the 1962 report. Given the many different types of munitions in use on any given engagement (5.56mm, 7.62mm, 300 Winchester Magnum, .338 caliber, 40mm explosive grenades, .50 caliber variants of munitions, 30mm high explosive rounds, 60 and 81mm mortar high explosives, tank main gun rounds, etc.), one would be hard pressed to clearly determine the cause of wounds in any human body, even if one were afforded the time and safety to conduct a forensic analysis, which is generally not the case in combat. It is important to understand that the infantryman rarely sees the individual enemy combatant that he is firing at in combat; fire is usually made from a distant covered position. This means what causes a wound cannot generally be confirmed nor controlled for in a combat situation. I can say from personal experience in combat, that I have seen multiple corpses believed to have been made by U.S. infantrymen fire that did not have noticeably large wounds, let alone missing limbs or heads. So while I do not question the integrity of the individuals who reported what they saw in the field, I do question whether what they believe they saw reflects reality.

Tellingly, despite the U.S. military's decades of combat experience since issuance of the Office of the Secretary of Defense's 1962 report, in which tens of thousands of enemy combatants have been shot by M-16/M-4 fire, its findings concerning wounds resulting from the AR-15 (M-16) that Mr. Andrew recounts in paragraphs 28-31 of his report have not been replicated by any study that I am aware of. If anything, they have been undermined by years of later studies. U.S. military services have used the M855 "green tip" 62 grain bullet in their M-16s from ~1982 through 2005, based on that bullet's perceived capabilities described in multiple doctrinal publications generated up to that point. Yet, despite those publications' endorsement, the military never fully tested that bullet for terminal effects. That changed shortly after the first significant ground fighting began in Iraq in 2003.



A draft document from the Marine Corps Systems Command, Program Manager for Ammunition, from January 2004, reveals infantry concerns with the perceived ineffectiveness of the M16 series family of rifles, or at least the bullets they fire, for incapacitating the enemy.<sup>7</sup> In response to constant complaints by infantrymen from 2003-2005 that the 5.56 mm ammunition that the M-16 uses was inadequate in terms of penetration, lethality, and terminal performance, the US Army commenced studies to consider replacing the M855 “green tip” 62 grain projectile. The findings of those studies conducted between 2005-2010 were that the M855 bullet underperformed in incapacitating enemy combatants and should be replaced. And, it was in fact replaced, as the US Army explained in a report.<sup>8</sup> Its replacement, the M855A1 Enhanced Performance Round, is a larger, more powerful round.<sup>9</sup> In other words, the military concluded, after studying the issue, that 5.56 x 45 cartridges with M855 projectiles fired from an AR-15 (M-16) were insufficient for modern military combat and needed to be replaced with rifles firing higher powered cartridges with larger bullets.

In paragraph 34 of his report, Mr. Andrew claims that “it was the semi-automatic capabilities, not the automatic capabilities, that made [the M-16] such a valuable weapon for deadly combat.” The only supposed support he provides for his claim is a quote from a US Army publication, FM 3-22.9, dated August of 2008, that semi-automatic fire is the “most important firing technique during fast-moving, modern combat,” and that “[i]t is surprising how devastatingly accurate rapid semi-automatic fire can be.” One of Illinois’s other experts, James Yurgealitis, relies on the same quotes from the same report for essentially the same premise, i.e., that “the most effective use of the M4 and M16 at ranges beyond 25 yards is rapid semi-automatic fire, not full-automatic fire.” (Yurgealitis at ¶ 51). Their reliance on that publication is misplaced.

First, that 2008 publication was updated in May of 2016, TC 3-22.9<sup>10</sup>. Significantly, this updated version does not include the referenced quotations that Messrs. Andrew and Yurgealitis rely on.

Additionally, Messrs. Andrew and Yurgealitis improperly rely on the 2008 FM 3-22.9 publication to draw conclusions about combat operations. That publication concerns marksmanship skills, not combat skills. Marksmanship publications in the military are intended to capture the best practices for developing initial skills with single weapon systems and focus on accuracy of each shot fired and accounting for all shots fired during the development of individual skills with a rifle or pistol. Marksmanship publications are *not* designed nor intended to teach tactical combat applications. They do not consider stress and exhaustion of the friendly fighters, obscurity of enemy positions (in combat, we seldom clearly see the opponents we are

---

<sup>7</sup> See **Exhibit 2**, 5.56mm AMMUNITION COMPARISON TEST REPORT, PHASE I, Draft January 2004, Marine Corps Systems Command, Program Manager for Ammunition

<sup>8</sup> See **Exhibit 3**, M855A1 Enhanced Performance Round (EPR) by LTC Jeffrey K. Woods, Product Manager, Small Caliber Ammunition

<sup>9</sup> Product Manager Small Caliber Ammunition, M855A1 Enhanced Performance Round (EPR) ATTN: SFAE-AMO-MAS-SETI, Picatinny, NJ 07806-5000

<sup>10</sup> See **Exhibit 4**, TC 3-22.9 Rifle and Carbine dtd May 2016. This publication supersedes FM 3-22.9 dtd 12 Aug 2008. Headquarters, Department of the Army.

trying to defeat), or the overall complexity of many different weapons platforms firing simultaneously with an opponent returning fire. The military does not teach automatic fire skills in marksmanship facilities. Automatic, or burst, firing skills are taught during tactical scenarios in field training environments using different publications than the marksmanship ones to guide these best practices. By relying on the 2008 FM 3-22.9 publication, Messrs. Andrew and Yurgealitis thus conflate marksmanship practice guides with combat practice guides, which should be ignored.

Finally, it is my belief that the author of the 2008 FM 3-22.9 publication included those statements based on his opinion, rather than on training or studies. I base my assessment on the training that I personally received in the USMC, which emphasized automatic fire as the most important combat function of a rifle. That training was based on decades of experiments and studies concluding the exact opposite of the FM 3-22.9 of August 2008 author's claim, i.e., that automatic rifle fire is the most critical element to gain fire superiority and to suppress enemy combatants into non-firing submission. Specifically, those studies have indicated the physical and psychological importance of automatic fires as they relate to suppression of enemy positions during high intensity combat. The following are quotes from several examples of these historical studies:

*The automatic rifle has significantly greater psychological effect than the semi-automatic rifle. This conclusion is supported by results from both the comparative judgments method and the absolute judgments method and is consistent with results of prior studies.<sup>11</sup>*

*The degree of psychological effectiveness of both weapons is a function of the volume of fire, the nearness of the fire, and the combat experience of the infantrymen.<sup>12</sup>*

*Maximum psychological effect can be achieved at a minimal ammunition expense by firing repeated short bursts. Thus, weapons should be capable of firing such bursts and training doctrine should emphasize it.<sup>13</sup>*

*A random pattern of fire produces as much psychological effect as a systematic pattern and kills more targets. Firers should be trained not to maintain a systematic pattern of fire but to place fire on target areas in a random manner. By firing in this manner, the enemy cannot diagnose a systematic pattern of fire and use it to his advantage.<sup>14</sup>*

---

<sup>11</sup> Research Study Report III, page 5, para D. 1. Referred to as the Whittenburg study, dated June 1957. Attached as **Exhibit 5**.

<sup>12</sup> Ibid, page 5, para D.2.

<sup>13</sup> Research Study Report VI, Psychological Effect of Patterns of Small Arms Fire dtd July 1957, page 14, para G.1. Attached as **Exhibit 6**.

<sup>14</sup> Ibid. Page 14, para G.2.

*Rifle squads equipped only with Colt automatic rifles appear superior to all other squads evaluated in overall effectiveness.<sup>15</sup>*

*For aimed fire on visible point targets during daylight, semiautomatic fire is superior to automatic fire. This is true for all rifles, both low and high muzzle impulse. This does not imply, however, that automatic fire may not be superior in suppression effects and hits on adjacent concealed targets.<sup>16</sup>*

*Dispersion of rounds from salvos or burst controlled so as to form a pattern such that aiming errors up to 300 yd will be partly compensated, and hit effectiveness thereby increased for these ranges.<sup>17</sup>*

No study that I have ever read or am aware of indicates that “semi-automatic fire is the ‘most important firing technique during fast-moving, modern combat.’” Tellingly, neither the author of the 2008 FM 3-22.9 publication nor Messrs. Andrew or Yurgealitis cite any report or other source, military or otherwise, to support that quote. This is further reason for my belief that the author of the obsolete 2008 FM 3-22.9 publication included that quoted statement based on his own unsubstantiated opinion and not any study; at least not one provided by the military.

### COMPENSATION

Jeffrey Eby is being compensated at the rate of \$180.00 per hour.

Dated: June 10, 2024

*s/Jeffrey Eby*  
\_\_\_\_\_  
Jeffrey Eby

---

<sup>15</sup> Small Arms Weapons Systems Study, Part one, dated Sep 12 1966 by US Army Combat Developments Command, Experimentation Command. Page 9-1, para 4. Attached as **Exhibit 7**.

<sup>16</sup> Ibid, Page 9-1, para 19.

<sup>17</sup> Operational Requirements for an Infantry Hand Weapon by Norman Hitchman, 1952 Operations Research Office, The Johns Hopkins University operating under contract with the Department of the Army. Attached as **Exhibit 8**.

# **EXHIBIT 1**

MARKSMANSHIP, MCNAMARA AND THE M16 RIFLE:  
ORGANIZATIONS, ANALYSIS AND WEAPONS ACQUISITION

Thomas L. McNaugher

March 1979

P-6306

#### The Rand Paper Series

Papers are issued by The Rand Corporation as a service to its professional staff. Their purpose is to facilitate the exchange of ideas among those who share the author's research interests; Papers are not reports prepared in fulfillment of Rand's contracts or grants. Views expressed in a Paper are the author's own, and are not necessarily shared by Rand or its research sponsors.

The Rand Corporation  
Santa Monica, California 90406

MARKSMANSHIP, MCNAMARA AND THE M16 RIFLE: \*  
ORGANIZATIONS, ANALYSIS AND WEAPONS ACQUISITION

Thomas L. McNaugher  
The Rand Corporation

I. INTRODUCTION

Those charged with managing the weapons acquisition process are often frustrated by the barriers to change posed by the military services, which generally prefer buying weapons that perform traditional missions in traditional ways. Newer generations of weaponry thus tend to look like previous generations, but for improvements in a few key areas of performance: fighter aircraft and bombers get faster, tanks grow heavier and more powerfully gunned, and so forth. Attempts to introduce what seem to be marginal changes away from established patterns of developing new weapons--buying a light fighter aircraft rather than a heavy one, for instance, or a smoothbore rather than a rifled main tank gun--often meet with little enthusiasm from the services. And the implementation of more significant changes--buying cruise missiles instead of manned bombers, for example--may demand political action at the highest level.

Organizations do change, however. Concluding a survey of organizational theory, Allison noted that the "parameters of organizational behavior mostly persist":

In response to nonstandard problems, organizations search and routines evolve, assimilating new situations. Such learning and change follow in large part from existing procedures, but marked changes in organizations do sometimes occur.<sup>1</sup>

---

\*This paper was prepared for delivery before the 20th annual convention of the International Studies Association, held in Toronto, Canada, March 21-24, 1979. It represents a condensation of the author's dissertation, *Marksmanship, McNamara and the M16 Rifle: Organizations, Analysis and Weapons Acquisition* (Harvard University, 1977). Omitted is one chapter which covers in detail the M16's technical development, and which relates the behavior patterns of the weapon's developers with the technical problems that for a short period plagued the weapon when it was being used in the Republic of Vietnam.

Such marked changes, Allison concludes, normally are precipitated by budgetary feasts or fasts, or dramatic performance failures. In the case of military organizations, the latter generally occur during combat, which accounts for the propensity of such organizations to change markedly only during periods of warfare.

None of this yields much comfort to those who would like to introduce innovative weaponry under less traumatic circumstances. These individuals would like to know when and under what set of circumstances an organizations is likely to change. Where can they look to get some measure of an organization's propensity to change? How can that propensity be tapped? Are there circumstances short of warfare that brighten the prospects for successful innovation in the weapons acquisition process? These are broad questions of major significance to defense managers and organizational theorists alike.

This essay will try to shed some light on tentative answers to these questions by examining a case study of successful organizational adaptation: the U.S. Army's shift in the 1960s from the M14 to the M16 rifle. The M16 was known as the ARL5 in 1962, when Defense Secretary Robert McNamara sought to interest the service in the piece. Having just completed the development of its own M14, the Army showed little enthusiasm for McNamara's idea. Indeed, the phrases "sought to interest" and "showed little enthusiasm for" do not capture the flavor of what was in fact a major power struggle over who would control the Army's rifle procurement process.<sup>2</sup> At the time, the battle ended in a compromise, with the service agreeing to buy only limited numbers of the ARL5, which it then renamed the M16. Nor is there evidence that in the years immediately following the controversy the Army Staff ever seriously considered buying more M16s. Yet in 1967, partly in response to the M16's popularity in Vietnam and partly in response to newly generated analyses that touted the rifle's merits, the Army fully adopted the weapon, dropping in the process the rifle it had so ardently defended only four years before.

The switch represented no small change. Although less important to combat success now than it was fifty years ago, the rifle remains



a potent symbol of military ground forces. It has been especially potent in the United States, where the Army and the rifle more or less grew up together, and where for a variety of reasons the rifle's importance as both weapon and symbol has been keenly felt. Armies do not alter their rifles easily, leastwise the U.S. Army; the weapon commands too many deepseated attachments to be changed capriciously.

In this particular case, the impediments to change were compounded by the fact that the two rifles at the center of this controversy embodied very different *concepts* of rifle fire. A powerful, accurate semiautomatic<sup>\*</sup> rifle, the M14 had been developed on the premise that aimed fire, the fire of trained marksmen, was of utmost importance in combat. To the U.S. Army this was more than a premise; it was a belief that had evolved over nearly a century since the service adopted its first rifle in 1855. Smaller and less powerful than the M14, but capable of spray-like (and very unmarksman-like) automatic fire, the M16 was the product of newer trends in rifle design based on the premise that marksmanship had at best a limited role to play on the battlefield. Behind this premise lay a solid case amassed mainly by civilian analysts in the years after World War II. The Army's shift from M14 to M16 was thus a change in concept and also a break with longstanding tradition.

It is the general theme of this essay that an explanation of why the Army first defended the M14 and then dropped it for the M16 must deal with organizational *subunits* and the state of consensus among them concerning a particular weapon concept. That the M14 looked like a marksman's rifle in this case obscured the presence of an intra-organizational debate about marksmanship's merits that

<sup>\*</sup>It is unfortunately the case that studies of the weapons acquisition process must often deal with technical issues unfamiliar to laymen. In this case, a few technical terms had best be clarified at the outset. A *semiautomatic* rifle is one that fires each time the trigger is pulled. An *automatic* rifle will fire as long as the trigger is depressed (assuming it neither overheats nor runs out of ammunition). This essay will subsequently refer to a weapon's *caliber*, which is the diameter, in inches, of its bore or the bullet it fires. A caliber .30 rifle thus fires a bullet 0.3 inches in diameter. As will become clear in a later section, the M14 and M16 differed significantly in caliber as well as capability.

preceded by some decades the AR15 controversy. Indeed, the AR15 was not originally McNamara's creation, but the product of Army officers unhappy with the traditional direction of the service's rifle acquisition process. By forcing the new rifle into the bowels of the organization, McNamara tapped the wellsprings of this debate. And with the added push provided by the Army's combat experience in Vietnam, the eroded organizational consensus around marksmanship finally collapsed, taking with it the Army's resistance to the M16.

To understand what happened here thus requires a rather close look at the Army's approach to small-arms as it evolved in the decades before the AR15 became the object of political debate. The next two sections look first at how marksmanship became an established service tradition that continued to dominate the rifle acquisition process even as soldiers began to favor other kinds of rifles made available by advancing technology. Section IV looks at how the AR15 came into existence, while section V examines McNamara's initial effort to interest the Army in the piece. The final substantive section relates the circumstances under which the service finally adopted the new weapon, and a concluding section then draws from the case suggestions for better understanding how large military organizations change.

## II. MARKSMANSHIP IN THE NINETEENTH CENTURY: BIRTH OF A TRADITION

J.F.C. Fuller has called the second half of the nineteenth century the "era of the bullet,"<sup>3</sup> and for good reason. On the one hand, by about 1860 effective rifles began replacing the smoothbore muskets popular through the century's first half, and this made the soldier's firearm a most accurate and deadly weapon. On the other hand, more modern weapons like recoil artillery and tanks, weapons that surpassed the rifle in deadliness and largely superseded it in combat, had not yet appeared. For the U.S. Army, however, this period was not simply the era of the bullet, but the era of the *aimed* bullet, the bullet fired by an expert marksman. For it was in these years that the Army elaborated a rifle doctrine stressing aimed fire at long range, a doctrine that became a genuine tradition of marksmanship. That tradition dominated the service's tactics, its training, and its approach to advancing small-arms technologies. It left a mark on the service still visible in 1960.

For decades before the American Civil War, inventors and soldiers alike knew that "rifling" the barrel of a musket—engraving spiralled grooves into it so as to impart spin to the projectile as it was fired—dramatically increased the weapon's range and accuracy. But the technical problems associated with making rifles were not effectively solved until about 1850.<sup>4</sup> And not until the Civil War, when muzzle- and breech-loading rifles found their way into combat in large numbers, did tacticians become fully aware of the rifle's usefulness. Its range, accuracy, and, in the case of the breech-loader, its relatively high rate of fire completely disrupted the old tactics based on massed troops, short-range volleys, and bayonet charges.<sup>5</sup> Indeed, the charge became near-suicidal in the face of rifle fire; Pickett's famous charge at Gettysburg cost him 75 percent of his men killed or wounded.<sup>6</sup> By the end of the Civil War the well-entrenched defensive position held by soldiers armed with rifles had become all but insurmountable, and a cruel trench warfare had set in. Similar lessons emerged from the European wars of the period.<sup>7</sup> The rifle revolutionized tactics.

While their European contemporaries experimented with forms of essentially unaimed volley fire, tacticians in the United States turned in the wake of the Civil War to tactics based on marksmanship. Emory Upton's *Infantry Tactics*, published in 1867, the year in which the Army began producing its first breech-loading rifle, was the first of a series of tactics manuals that emphasized the importance of the individual soldier's ability to acquire targets at great range. By 1880, these texts had created a highly refined tactical system in which the small unit leader spotted targets and carefully controlled the aimed fire of his men. Fire superiority depended on "the number of hits, not upon the number of shots fired,"<sup>8</sup> and such hits were expected to occur at ranges out to 1000 yards or more.<sup>9</sup> Significantly, the Infantry's School of Musketry, created in 1907, was called the "School of Precision."<sup>10</sup>

Upton's text also introduced target practice out to about 800 yards, and the tactics books that superseded it over the years increased the emphasis on this kind of training.<sup>11</sup> A soldier, as one general noted, "should be at home with his rifle at 800, 1000, or even 1200 yards."<sup>12</sup> Target practice became a virtual "religion."<sup>13</sup> And the U.S. Army became what one of its top generals proudly called "an army of marksmen...."<sup>14</sup>

The nation's frontier experience no doubt had much to do with this turn to marksmanship; Indians had always had a rather accurate weapon in the bow and arrow, hence accuracy had been more important in the U.S. than in Europe. And fighting Indians, a kind of warfare that took small patrols away from their supply base for weeks on end, made it essential that "every shot count." The frontier provided its own mythology, too. Americans were said to be born "with rifles in their hands," and officers could appeal to the heritage of Daniel Boone, or, later, Annie Oakley. The nation's heritage also created in the society at large strong reinforcement for the service's choice of tactics. In the 1870s a group of militia officers anxious to improve the marksmanship of the American soldier created the National Rifle Association. Soon they had organized annual shooting matches in which the Army's best shots met their civilian counterparts. By the end of the nineteenth century, the "National Matches" had acquired

enormous importance to the Army, and winning a place on the Army's Team had become a matter of some pride to its infantrymen.<sup>15</sup> In this way the Army and American society communicated to each other their mutual esteem for fine marksmanship.

A doctrine based on marksmanship also satisfied the very specific needs of various subcomponents of the service. The Army's Ordnance Department, the agency that developed and produced the service's rifles and ammunition, preferred a tactics that stressed slow and deliberate fire because it meant less waste of ammunition and hence less strain on the Department's supply lines and production facilities.<sup>16</sup> Meanwhile, those involved in training liked marksmanship because it was popular with the troops and yielded measurable results, both matters of some importance to a peacetime or home-front army.

Marksmanship thus had a different but special appeal to nearly everyone in the service, and this may account for its pervasive influence over the service's approach to developing new rifles. Between 1867 and 1900 the Army faced evolutionary advances in both small-arms ammunition and small-arms themselves. Normally it approached major advances by convening a "board"—a committee of Ordnance Department technical experts and "user" branch officers, in this case infantrymen. If the board found a particular advance or invention to its liking, the device usually would be sent in quantity to line units for field testing. The history of the board's consideration of the device plus the experience of line units then would be sent up through the Army Staff for recommendation and thence to the Commanding General (more recently the Chief of Staff) for final decision. Although a slow and laborious process, this one had the advantage of generating a fair amount of consensus around a new weapon before the device was "standardized" (named a standard inventory item), prepared for production and, finally, distributed to using elements.

No one in the U.S. Army found much to complain about in the major advances in small-arms ammunition that marked the period. New and more efficient gunpowder permitted rifles to fire further

and with greater accuracy, as did more aerodynamically sound projectiles. The Ordnance Department's ammunition experts continuously worked to perfect such advances and apply them to the Army's existing cartridges.<sup>17</sup>

Because the period's major advance in small-arms design permitted increased rates of fire, however, the service tended to see it as unnecessary or even dangerous to the soldier's marksmanship skills. Indeed, the Army employed upgraded versions of its original 1867 single-shot breechloader through 1892, even though magazine rifles—which could be loaded with the flick of a bolt or lever—had been available since the Civil War. The troops themselves, as well as the Ordnance Department, preferred the single-shot piece.<sup>18</sup> Only when pressured by the Congress as well as by the knowledge that most European armies had adopted magazine rifles did the service finally relent in 1892 and purchase the Krag-Jorgensen caliber .30 magazine rifle. Significantly, when it did so it taught its soldiers to fire the weapon as a single-shot piece, reserving the rounds in the weapon's magazine for emergency use only.<sup>19</sup>

Army regulars carried the Krag into Cuba in 1898 only to discover that it was grossly outranged and outpowered by the Mauser rifles Spanish troops carried. Thus, early in the next decade the Ordnance Department built its own Mauser, the 1903 Springfield, a bolt-action magazine gun that to this day is considered one of the most accurate military rifles ever developed. The rifle's reputation drew largely from the cartridge developed for it in 1906, a caliber .30 round of relatively high power that came to be called the .30'06 (thirty-ought six) after its caliber and the year of its introduction. As it had with the Krag, the Army trained its regulars to fire the '03 Springfield as a single-shot piece, aiming each shot.<sup>20</sup>

The 1903 Springfield was developed at a time when the popularity of marksmanship doctrine was probably at its highest. In the kind of warfare that occupied the service between 1865 and 1917, marksmanship had real value. That troops enjoyed marksmanship training made the doctrine equally valuable during peacetime. Meanwhile,

the Army's logisticians and production experts had their own reasons for liking the doctrine. Finally, marksmanship continued to give the service a tie with the society around it through the ever popular National Matches.

Less noticeable at the time but increasingly important in the years thereafter were two indirect sources of the doctrine's popularity that tended to sustain its hold on the development of new small-arms. One of these was the logistician's preference for ammunition commonality.<sup>21</sup> Field commanders and Ordnance Department technical experts alike always liked to minimize the types of cartridges shipped to field units. Doing so solved distribution and supply problems in the field, and kept to a minimum the number of ammunition production lines the Ordnance Department had to keep open. As machineguns became more prevalent toward the end of the century, the notion thus developed that the Army's rifle and its smaller machineguns should use a common cartridge. This tied the development of new rifles to the high-powered cartridge necessary for the long-range machinegun barrages envisioned by military tacticians. Since a marksman's weapon normally fired such a round in any case, commonality at the time it emerged was quite compatible with the ongoing direction of U.S. rifle developments.

The other source of marksmanship's staying power was the Army's perpetual lack of money. Penury had always reinforced the service's natural military conservatism, it being cheaper to keep producing the same item—or to produce no item at all—than to invest in the development of and the production tooling for a new one. Because rifles fired many times their own value in ammunition, this financially induced conservatism applied to the cartridge more than to the rifle itself. Once the Ordnance Department had developed a new cartridge like the .30'06—a task that was becoming increasingly time-consuming and expensive as technology advanced—it was less than anxious to begin the process over again. And once the Army's growing war reserve stocks of ammunition had been filled out with the new round, financial considerations made it even more traumatic to contemplate developing a new round.

The power of these logistics and financial considerations largely went unnoticed at the turn of the century. Commonality demanded that the rifle fire a high-powered cartridge, but a marksman wanted his rifle to fire such a round in any case. Indeed, the .30'06 round that gave the '03 Springfield its remarkable range and accuracy made a splendid machinegun cartridge as well. And though financial conservatism made it difficult to develop a new cartridge, at the time no one wanted a new cartridge; the .30'06 seemed destined to fulfill the Army's needs for some time to come. Tactical, logistical, and financial considerations thus mutually reinforced one another.

The problem was that neither commonality nor the Army's penury had much to do with tactics. Thus, while in the years ahead the Army's tactical needs grew more complicated, financial and logistics considerations continued to impede the development of a new cartridge. And because the capabilities of a cartridge largely control the capabilities of the rifle that fires it, these essentially nontactical considerations also exerted a good deal of control over rifle developments. These considerations thus loomed much more important in the twentieth century, when marksmanship's positive appeal began to fade.



III. MARKSMANSHIP IN THE TWENTIETH CENTURY: DECLINE OF A TRADITION

Whatever tactical utility marksmanship may have possessed for a frontier army disappeared steadily after the turn of the century. Many U.S. soldiers noted its passing, and their experience in each World War moved them to question marksmanship's precepts and to favor alternative kinds of small-arms decidedly different from those called for in the service's traditional doctrine. Yet the marksmanship tradition continued to exert a strong influence over the service's approach to the rifle development and the rifle's use in combat. The tradition was simply too important to the service in too many ways to be easily cast aside when it no longer made tactical sense.

The "era of the bullet" began its decline at about the turn of the century, when new weapons came along to take over the rifle's starring role in combat. Both machineguns and modern, recoil artillery<sup>22</sup> had been developed toward the end of the previous century, but were not fully appreciated until the time of the First World War. Both sprayed the battlefield with bullets and, more importantly, shrapnel in a way the rifle never could. The trenches of World War I bore witness to the power these new weapons gave to the defense, while statistics show how they undermined the rifle's dominance of combat: whereas in the Civil War and the European wars that followed soon after it about 70 percent of all casualties were caused by rifle fire, samples taken during World War I showed bullets (machinegun as well as rifle) accounting for 40 percent to 50 percent of all casualties, shrapnel causing the remainder.<sup>23</sup>

Marksmanship's utility declined as well. The presence of so much shrapnel and machinegun fire on World War I battlefields made it dangerous indeed for the marksman to raise his head to coolly aim and fire. Besides, enemy soldiers rarely presented themselves as targets quite so willingly as Indians on horseback had in the previous century. Indeed, American soldiers fighting in Europe in 1917 were often quite shocked when they fought two or three battles before they saw an enemy soldier.<sup>24</sup> And the targets they saw were often

only a hundred yards away, the usual distance between the trenches of opposing sides. Such ranges hardly tested the enormous power of the .30'06 cartridge or the skills of the nation's marksmen. Submachine-guns and machine pistols often replaced the marksman's rifle in this war in which, as one American observer put it, "every conceivable type of fast-firing gun" was employed to "shower lead on the enemy."<sup>25</sup>

Although some of these trends were visible even before the United States entered the war, General John J. Pershing nonetheless stressed target practice for the troops of his American Expeditionary Force.<sup>26</sup> And on occasion that training proved useful. At Belleau Wood, for example, U.S. marksmen, free of the trenches and engaged in relatively open fighting, often took German soldiers under fire at over 1000 yards range. The deadliness of their fire apparently tempted the Germans to conclude that they were being machinegunned.<sup>27</sup>

Despite these demonstrations of marksmanship's usefulness, American soldiers spent enough time in the trenches of World War I to see a need for other kinds of rifles and tactics. In particular, many soldiers wanted a weapon that would provide a high volume of fire. In response to these needs, the Ordnance Department developed the "Pedersen Device," which fit inside the breech of the soldier's rifle and converted it to a machinegun firing relatively low-powered pistol bullets. Though for a variety of reasons the Pedersen Device was never produced, its development in response to demands from the field suggests how strongly many American soldiers felt about the need for small-arms capable of volume, as opposed to precision, fire.<sup>28</sup>

Perhaps because the U.S. experience in the war produced ambiguous evidence as to marksmanship's utility, the war also produced a debate about rifle fire that went largely unresolved. This debate is perhaps best defined by the definition opposing sides of the debate gave to the term "fire superiority." The traditionalists argued that fire superiority still lay "with the side...able to deliver the greater volume of accurate fire—in other words...the greater number of hits per minute."<sup>29</sup> Those unimpressed with marksmanship's usefulness in combat, on the other hand, preferred the notion of "area fire,"

defining fire superiority as that "fire which holds the enemy down so that moving troops can advance toward him."<sup>30</sup>

Although this debate raged as the war itself raged, in the years after the war it abated, and official policy reverted to its traditional stress on marksmanship. To be sure, the need for more rapidly firing weapons could not be ignored. But the Army's rifle manual of 1920 made it clear that accuracy should not be sacrificed for rapidity; soldiers should be capable of firing "10 to 15 accurate shots per minute."<sup>31</sup> Marksmanship training thus remained the mainstay of the U.S. infantryman's training diet. Most important, the tradition continued to dominate the development of new rifles. Britain, France, and, later, Germany ignored rifles almost entirely after the war and set about developing better automatic weapons. By contrast, the U.S. Army sought in 1919 to begin development of a semiautomatic rifle, one which fired each time the trigger was pulled and thus promised to allow more rapid fire without undermining the soldier's accuracy.<sup>32</sup> The Ordnance Department hired one John Garand, a civilian inventor of considerable talent, to develop the new piece.

The task of building such a rifle was not a technically easy one. If the service had trouble reconciling the demand for weapons capable of rapid fire with its marksman's tactics, it also had difficulty achieving high rates of fire in a rifle that fired the marksman's favorite bullet, the .30'06. Built to retain its accuracy and lethality at ranges of well over 1000 yards, the .30'06 generated much heat and recoil each time it was fired. A rifle firing that round needed a certain amount of weight simply to absorb the heat and keep the recoil from battering the firer senseless. Yet the service wanted the new rifle to be slightly lighter than the weapon it replaced. The 1903 Springfield had "kicked" badly enough; asking for a weapon both lighter and somewhat faster firing than that old rifle pushed the Army's rifle requirement very close to the limits of what was practically possible. Not surprisingly, Garand's work produced no immediate result.

With no semiautomatic rifle to show for five years' work, the service in 1924 called on still another talented civilian small-arms

expert, John Pedersen. Pedersen made the very obvious suggestion that the best way to get a semiautomatic rifle was to give up the .30'06 cartridge. He recommended instead a smaller and less powerful caliber .276 cartridge of his own design. Such a round had several other advantages besides allowing the development of a semiautomatic rifle. It was smaller and lighter than the .30'06, and hence was easier to pack and ship in bulk. In the long run it would also be cheaper to produce. And because a rifle chambered for it would "kick" much less than the old Springfield, it promised to make training easier by lessening the fear new recruits usually had for the Springfield.<sup>33</sup>

Despite the round's advantages, the service did not take to Pedersen's idea enthusiastically. Instead, it convened a special "Caliber Board" simply to consider the issue. Although members of the Board favored Pedersen's idea, others in the service, especially at its highest levels, did not. The complaint was raised that a change of cartridge violated commonality and the need for "interchangeability of standard ammunition and war reserves...." The Chief of Ordnance noted that the decision would render useless the Department's tooling for the manufacture of caliber .30 cartridges. And a great many infantrymen expressed concern about the possibility of giving up the range and accuracy of the .30'06 round. The marksmanship tradition retained a good deal of popularity despite the Army's experience in World War I.

This debate continued into the 1930s, when pressure from the Congress for *some* decision finally forced the service to action. In 1933 the Caliber Board decided to standardize both the Pedersen round and a semiautomatic rifle Garand had designed to fire it. Chief of Staff Douglas MacArthur, however, overruled the Board, arguing that it would be too expensive to fully develop and produce the new round, and that its introduction into the Army's supply system would be too confusing.<sup>34</sup> MacArthur thus sided with his logisticians.

It was fortunate for the service that Garand had sensed the Army's resistance to a change of caliber and finally, in the late

1920s had prototyped a semiautomatic rifle that fired the .30'06 round and *almost* met the original weight requirement. With MacArthur's decision Garand returned to this weapon, perfected it, and in 1936 saw it standardized as the M-1. In a very real sense, Garand thus saved the Army from having to face the tough choices forced upon it by its effort to combine new capabilities in rifle fire with traditional ones.

As it happened, MacArthur's decision and the M-1's subsequent development proved most fortuitous. For the M-1 gave the Army outstanding service during the Second World War. Field commanders praised the rifle's accuracy, power, and reliability, while Patton called it "the greatest battle implement ever devised."<sup>35</sup> The Army's logisticians liked the M-1, too. Partly because it was a semiautomatic weapon and partly because the nation had in existence a sizable production capability for producing the .30'06 cartridge, the M-1 did not, apparently, place undue strain on the nation's production and supply capability. W.H.B. Smith, for example, considered MacArthur's decision to keep the caliber .30 round most prescient, given the enormous wartime demands placed on the nation's "huge industrial capability for manufacturing cartridges of this caliber and design."<sup>36</sup>

The M-1's popularity virtually guaranteed the dominance of its capabilities over the Army's future small-arms developments. "Battle experience," a Department of the Army bulletin asserted some years after the war, "has proved beyond question the effectiveness of the present rifle [M-1] and ammunition...."<sup>37</sup> And, given that the M-1 was a marksman's rifle—had been deliberately designed to allow soldiers to fire the "maximum number of aimed shots,"—its popularity insured that marksmanship doctrine, too, would remain important in the Army's rifle tactics.

Notwithstanding the *rifle's* popularity, the *doctrine* did not fare well during the Second World War. A variety of new weapons—tanks, bazookas, mortars, and so forth—combined during the war to limit the rifle's impact on combat operations still more than it had been limited in World War I. Only 25 percent of battlefield casualties

sampled in Europe, and 33 percent of those sampled in the Pacific Theater, were caused by rifle fire.<sup>38</sup> Shrapnel accounted for the remainder, and by its presence made it more dangerous than ever for riflemen to carefully aim and fire their shots. Meanwhile, targets were no more plentiful than they had been during World War I. Indeed, on this score the Army's marksmanship training proved dysfunctional; trained to fire only at targets, soldiers who saw no targets fired no shots! As historian S.L.A. Marshall put it, "the doctrine of fire discipline has accented for so long the need for controlled fire that it has almost obscured the fact that the fundamental problem is how to build up fire volume...."<sup>39</sup>

Thus, during the war the doctrine, and to a lesser extent the rifle itself, often had to be replaced by field expedients. Patton's troops were taught "marching fire" tactics, wherein they systematically returned fire in the direction from which it came, whether or not targets were visible.<sup>40</sup> In the Pacific Theater, where jungle foliage placed limits on the usefulness of the M-1's range and accuracy, soldiers often carried submachineguns or carbines that fired automatically. The same was true for soldiers engaged in some of the tough house-to-house fighting common in the Italian campaign.<sup>41</sup>

Hence, World War II produced a debate about rifles and rifle tactics similar to that which had followed the First World War. Most of the service's infantrymen agreed, for example, that during the war a "need frequently existed for the delivery of a large volume of fire for a short period of time."<sup>42</sup> Most thus sensed the need for a rifle capable of a higher rate of fire than the M-1. Yet the infantrymen who gathered at Fort Benning in 1946 to discuss the war's impact on rifle tactics nonetheless concluded that "aimed fire is still the deciding factor in combat."<sup>43</sup> Official doctrine in the years after the war thus continued to espouse the precepts of marksmanship, and marksmanship training continued to be widely employed. Still, there existed after World War II a sizable group of U.S. infantrymen who preferred an "assault rifle"—a lighter weapon of less power than the M-1 but capable of volume fire.

As it had after the First World War, the Army sought in 1946 to integrate the demands of soldiers for more rapid firing weapons into what remained essentially a marksman's rifle. Specifically, the board of officers that convened in 1946 to write the Army's postwar rifle requirement argued that the M-1 should be replaced by

a new lightweight caliber .30 rifle of the following general military characteristics: 7-pound maximum weight; capable of selective semiautomatic and automatic fire; and ballistic performance approximately equivalent to that of the present standard rifle.<sup>44</sup>

The pattern here was no different than it had been in 1921 or 1892; with one foot planted firmly in the marksmanship tradition, the service was trying to reach out to accommodate new needs in rifle capabilities.

This pattern had barely produced success in 1933; now it failed. The board's requirement may have satisfied major protagonists in the postwar debate over rifle tactics, but it was technically almost impossible to meet. Even a semiautomatic rifle weighing seven pounds could not be made to fire a cartridge as powerful as the .30'06 without kicking fiercely. And on automatic fire such a weapon promised to both rise out of control and overheat quickly when fired.<sup>45</sup>

The Ordnance Department's development during the war of a new caliber .30 cartridge to use in the new rifle did not really promise to get the service out of this dilemma. By using a smaller amount of more efficient powder than had been used in the original .30'06, the Department's small-arms experts were able to cut about half an inch in length from the .30'06 without diminishing the round's power. The new round, called the T65, thus answered the Army's need for a cartridge of "ballistic performance equivalent to that of the present standard rifle." And because it was shorter than the .30'06, it promised to allow the design of a rifle with a shorter breech that would thus be somewhat lighter than the M-1. From the Department's point of view, of course, the T65 had other advantages. It preserved

the usefulness of much of the tooling then used to produce the .30'06. And because it was a good machinegun round, it preserved commonality as well. Finally, its smaller size made for somewhat more efficient packing.<sup>46</sup> But because the T65 had all the power of the .30'06, it promised to cause the same problems that older round would have caused in a lightweight automatic rifle.

Although the technical problems embodied in the Army's rifle requirement could have been predicted in 1946, they did not become painfully obvious until the end of the decade. In 1949 the Ordnance Department finished its first prototype of a rifle it hoped would meet the requirement. The rifle fired the T65 cartridge and weighed just over 7 pounds. But it had to meet with the approval of members of the Infantry Board, a group of infantrymen who by this time were formally ensconced at Fort Benning, and whose duty it was to represent the "user"—the infantryman—in the Army's weapons development process by testing, suggesting improvements in, and finally approving new infantry weapons. At Fort Benning the rifle's limitations became immediately apparent. In tests it kicked ferociously when fired even semiautomatically. And unless supported by a bipod, it was quite uncontrollable when fired in the automatic mode.<sup>47</sup> Members of the Infantry Board suddenly realized that as long as the T65 cartridge remained the centerpiece of the Army's rifle development program the service's postwar rifle requirement would not be met.

At this point the British stepped in to play the role John Pedersen had played after World War I. Within the new NATO alliance, the U.K., in particular, had gone in a very different direction from the U.S. with its postwar rifle development. After interviewing combat veterans, Britain's small-arms experts concluded that few soldiers fired over about 300 yards in combat, and that fewer still bothered to aim their shots. Hence, these experts chose to develop an "assault rifle," a small, light weapon called the EM-2 that fired a relatively low-powered caliber .276 cartridge. When, after 1948, the alliance tried to standardize a common rifle cartridge, the U.S. T65 and the British round became the two main candidates.<sup>48</sup>



The British caused quite a stir when they brought the EM-2 to the U.S. for tests, for in firing it members of the Infantry Board suddenly realized that the only practical way to meet the Army's need for a lighter rifle capable of automatic fire was to dispense with the T65 cartridge.

Like the Caliber Board before it, the Infantry Board initially opted to standardize the smaller cartridge. But it was soon overruled by higher levels in the Army Staff. At those levels a good deal of support still existed for a rifle like the M-1, whose wartime fame had hardly abated. Army Staff members also felt that it would have been politically difficult to justify a change of caliber—and the change in rifle concept that went with it—to Congress and the public, aware as these groups were of the M-1's popularity. And the Ordnance Department had no desire to throw away the T65 or the tooling on hand to make it. As there had during the 1920s, there existed in 1950 more flexibility on the caliber issue at the bottom of the organization than at the top.

Significantly, in the wake of overruling the Infantry Board, the service altered its original postwar rifle requirement to reflect a more realistic approach to a rifle development based on the T65 cartridge. The 7-pound weight requirement was dropped well down the Army's list of priorities, as was the need for an automatic fire capability. "Stopping and wounding power" and "accuracy in semiautomatic fire" were given top priority. The goal for the Army's postwar rifle development project now took on a very traditional air; to produce a rifle "capable of delivering the maximum number of aimed shots when fired by a soldier trained in marksmanship."<sup>49</sup>

Although the British continued to favor their EM-2, the dominant economic and military position of the United States within the NATO alliance made it difficult for them to resist U.S. pressure to accept the T65 round as standard. When Winston Churchill became Prime Minister in 1953, he finally cancelled further work on the EM-2, a decision which caused much criticism in Parliament, but which remained in force nonetheless. Later that year the T65 became the

"7.62 millimeter [caliber .30] NATO standard" cartridge. The U.S. Army's ballistics preferences, tied as they were to the marksmanship tradition, thus were chiselled into the stone of an international agreement.

It would be some years before the Army got its new rifle; the M14 was not standardized until 1957, and did not go into production until 1959. Nonetheless, with the "NATO caliber controversy" resolved in a fashion remarkably similar to the way in which MacArthur had put an end to the earlier caliber controversy, the M14's characteristics were foreordained. It would be, and indeed was, a marksman's rifle, essentially capable of the M-1's range and accuracy.<sup>50</sup>

But if the M14 had a very traditional look to it, its development did not indicate the continued health and vitality of that marksmanship tradition. The Army's postwar rifle board, after all, had asked for more than just a marksman's rifle. And the Caliber Board had been willing nearly two decades earlier to drop the traditional caliber .30 cartridge. Both caliber controversies bore witness to the increasing amount of organizational fragmentation that surrounded the rifle issue. The M14 took a traditional form because insufficient fragmentation existed to pull rifle developments from their traditional path.

IV. THE INFANTRY BOARD AND THE FIRST RIFLE CONTROVERSY

To understand the M16's origins it is useful to see the Army's twentieth century rifle programs in *organizational* terms. Both world wars sparked heated intra-organizational debates concerning the rifle capabilities most appropriate to modern warfare. Both postwar rifle requirements sought to contain in one weapon the demands of major organizational factions involved in these debates. This helps explain why the two rifle requirements grew successively less practical in a technical sense; they were not designed with technical criteria foremost in mind, but rather were articulated in an effort to still a possibly rancorous organizational debate. By overcoming the technical problems inherent in the Army's semiautomatic rifle requirement, Garand thus performed the organizational function of satisfying all major parties to the Army's rifle debate. But not even a Garand could have performed the same feat in 1946. A choice had to be made, and in 1950 the Army Staff made the choice on traditional grounds. In so doing, however, it left unhappy that portion of the Army's infantrymen who wanted new and nontraditional rifle capabilities. It was men such as these who struck out on their own in 1957 to have developed a new and innovative rifle that they felt would better meet the demands of combat than the M14. The rifle they saw developed later became the M16.

The men in question were members of the Infantry Board, the infantryman's representative in the rifle development process. Tucked away at Fort Benning, the "Home of the Infantry," this group of 30-40 individuals<sup>51</sup> expressed in its activities during the 1950s the infantry's indecision about what kind of rifle it wanted. Between 1950 and 1957 the Board tested a variety of rifles besides the one that would become the M14. Some of these other rifles were American made, while some were of foreign design. Some fired the caliber .30 T65 round, while others were chambered for smaller caliber cartridges.<sup>52</sup> Perhaps because its membership changed frequently, the Board expressed no consistent preference in testing these weapons; in a very real sense

its members were searching, and not finding, a weapon that provided everything the service had asked for in its postwar rifle requirement.

Not until 1957 did the Infantry Board finally overcome this indecision, break ranks and seek an alternative to the M14. In part this break can be attributed to personalities; in 1956 the Board came under leadership that was quite unimpressed with the M14.<sup>53</sup> More important, however, the Board's decision was sparked by its access to an accumulation of innovative work on the design and use of military rifles conducted between 1950 and 1956 by two research organizations. The Operations Research Office (ORO), a largely civilian "think tank" created in 1948, applied operations research techniques to the problem of rifle fire in combat. At the same time, the Army's own Ballistics Research Laboratory (BRL) experimented with ballistics concepts involving small-caliber rounds. The work of both organizations tended to undermine the intellectual rationale for the M14. It thus provided impetus and intellectual direction for the Infantry Board's break with the Army's official rifle development project.

ORO turned its attention to the rifle's role in combat during the Korean War.<sup>54</sup> Some 150 ORO analysts went to Korea during the war, and in the course of their research documented a potent case against the major tenets of the marksmanship tradition. Marksmen were supposed to fire their weapons to great range; ORO found that the average range to which infantrymen fired their rifles in Korea was about 200 yards. Marksmen were supposed to aim their shots; a sampling of infantry in Korea showed that they rarely saw targets, and aimed about one shot of every eight. Indeed, most soldiers assumed that "the job of the rifleman [was] primarily to pour out as much lead as possible to keep the enemy's head down."<sup>55</sup> The principles of "area fire" had apparently become the rule despite the Army's marksmanship training.

Tests the ORO conducted after the war showed that the stress of combat and the speed with which enemy targets normally appeared and disappeared made it unlikely that *in warfare* the Army's *best* marksman would do any better than its *worst* at hitting enemy targets.<sup>56</sup> Thus,

the ORO gave up hope for recapturing the benefits of marksmanship through better training, as had been the service's traditional response to the experience of the two world wars. Instead, ORO began work on "multiple" rounds, single cartridges that fired two or three small bullets at once in a pattern. Like a shotgun, a rifle firing such rounds in some sense sprayed the target area, and this, not better aiming, promised to increase the probability of hitting the enemy.<sup>57</sup>

While ORO examined the potential of multiple rounds, analysts of the Army's Ballistics Research Laboratory took a closer look at the sources of a bullet's lethality. The Caliber Board's tests in 1928 and 1930 had suggested that a bullet's mass had less to do with its lethality than had previously been assumed. With this premise as their point of departure, analysts at BRL showed that the bullet's velocity was in fact more important than its size in determining lethality. BRL found that relatively small bullets—caliber .22 or .25, for example—if sent on their way fast enough, could be just as deadly as the Army's traditional caliber .30 slug. Comparing the performance of the M14's T65 bullet with two of the experimental rounds demonstrated during the early 1950s, Table I gives some idea of the differences in bullet size and velocity BRL considered during this period.<sup>58</sup>

TABLE I: COMPARISON OF EXPERIMENTAL CARTRIDGES

Cartridge Caliber	Bullet Weight (grains)	Muzzle Velocity (fps)
Caliber .30 (T65)	155	2700
Caliber .22	40	3100
Caliber .22	68	3500

Significantly, the second of the two caliber .22 slugs outperformed the .30'06 at ranges of 2000 yards.<sup>59</sup>

Unlike ORO, which posited no combat usefulness in marksmanship, BRL saw small-caliber, high-velocity rounds as genuinely beneficial to the soldier's marksmanship skills.<sup>60</sup> Such cartridges "kicked" considerably less than the old .30'06. Firing them thus incurred less of the deflection or aiming error normally associated with recoil. Small-caliber, high-velocity rounds also had all the other advantages Pedersen had noted in 1924; lighter weight, cheaper production cost, and so forth. Thus BRL became a staunch advocate of the Army's rifle tradition. But because it advocated smaller caliber cartridges than the T65, its work was subversive to the ongoing M14 development project.

Neither BRL's nor ORO's work saw wide exposure in the service as a whole. But it did come to the attention of members of the Infantry Board. In large part this was due to the fact that both organizations cooperated in conducting major tests of their ideas on rifle ranges at Fort Benning in 1956.<sup>61</sup> The results of these tests supported the notion that multiple rounds could significantly improve hit probabilities in combat. But the test results were less important than the fact that members of the Infantry Board witnessed the tests and were thus treated to a full range of arguments and information on the nature of rifle fire and available technical alternatives in rifle design. Armed with the information emerging from the tests, the Board put together the requirement for the kind of rifle it thought would be a good replacement for the M-1. From ORO it took the idea that the Army's rifle did not need to fire as far as the M-1 or the M14. From BRL it took the idea that small-caliber, high-velocity rounds would give a rifle all the lethality and accuracy it needed without much heat or recoil. This would then make possible the rifle the Army had originally asked for in 1946: a 7-pound weapon capable of automatic as well as semi-automatic fire.

The Board was convinced that the Ordnance Department would never give it the rifle it had in mind. Indeed, the Ordnance Department had not paid much attention to the Infantry Board since 1950. Thus, these officers turned to Eugene M. Stoner, a civilian designer whose

innovative caliber .30 AR10 had been demonstrated to the Board in 1956. Bringing Stoner to Fort Benning in 1957, the Board gave him access to the rifle test results and discussed with him their requirement for a new rifle. With the blessing of their parent organization, the Continental Army Command (CONARC), the Board's members used CONARC (not Ordnance Department) funds to finance Stoner's work on ten prototypes of the rifle they had in mind.

Stoner brought his first AR15 prototypes to Fort Benning in the spring of 1958. It was a strange looking little rifle, lighter and much smaller than the M14 and shaped of black plastic; a weapon soldiers to this day believe was invented at the Mattel Toy Company.<sup>62</sup> Stoner had chosen a caliber .223 (5.56 mm) round, not much bigger around than the bullet young boys used for target practice. But behind that bullet Stoner had packed enough powder to send it flying at some 3150 feet per second. To ranges of 500 yards the AR15 was a very deadly weapon indeed.<sup>63</sup>

Over the summer the Infantry Board ran Stoner's rifle through the standard series of tests it conducted for rifles, using the M14 as the control weapon. These tests showed that the M14 outperformed the AR15 only at ranges over 500 yards—ranges no longer the province of rifle fire by ORO's standards. Otherwise, the Board found the AR15 superior, especially by virtue of its light weight and the ease with which it could be fired automatically without climbing out of control. In September the Board formally recommended that the AR15, not the M14, replace the M-1 in the Army's inventory.<sup>64</sup>

This created a real problem for the Army Staff. By 1958 the service had firmly wedded itself to the M14. That rifle had been declared standard in 1957. The Congress had been briefed on its excellence and was now preparing to grant funds for its production. That the M14 used the NATO-standard cartridge—a cartridge more or less forced upon members of the alliance in the first place by the United States—made its adoption all the more important. Since 1950 the service had boxed itself into a corner in which stood only one rifle—the M14.

The Army Staff's problem had an organizational dimension as well. The provocative work done by analysts at ORO and BRL had been rather closely held during the 1950s, not least because it so thoroughly undermined the rationale for the M14's development. While ORO had been busy showing why marksmanship had no role in combat, marksmanship training had actually enjoyed a renaissance in the service at large.<sup>65</sup> At the same time, there remained many in the Army's higher echelons who retained fond memories of the M-1 their troops had carried in World War II.<sup>66</sup> Notwithstanding the Infantry Board's preferences, the organization as a whole was probably not ready to accept a rifle so radically different in appearance and capability as the AR15.

Finally, the Army Staff had to face the fact that the Ordnance Department absolutely disdained the new weapon.<sup>67</sup> To some unmeasurable extent this disdain reflected the pride the Department's small-arms experts took in their own M14. It also reflected the preference many of them retained for rifles capable of great range and accuracy; the marksmanship tradition did not lack for popularity in this organization. But the Department's disdain had a technical dimension as well. These experts were aware of how difficult it could be to make a prototype like Stoner's AR15 into a rifle capable of being mass-produced. With some legitimacy, they felt that the Infantry Board was technically naive in recommending the AR15 as fully developed and ready for production like the M14.

Given the enormous momentum behind the M14 at the Army Staff level, the outcome of this first rifle controversy was probably foreordained. Still, the Infantry Board's actions raised the issue of organizational change in a way that could not be ignored. When was the service as a whole going to take account of all the innovative thinking about rifles and rifle fire that had taken place earlier in the decade? Until the Infantry Board financed the AR15's development, the Ordnance Department and the Army Staff had implicitly assumed that these new ideas would apply to the Army's *next* rifle, an assumption that provided the time to deal with the political and organizational problems that in the 1950s made real change so difficult. This convenient assumption could no longer remain implicit.



As a counter to the ARL5, the Ordnance Department now came up with plans for a truly innovative rifle that came to be known as the "Special Purpose Individual Weapon," or the "SPIW."<sup>68</sup> Once developed, the SPIW would fire tiny flechettes—nail-like, fin-stabilized projectiles—at extremely high velocities. And it would fire three such projectiles at once, in the kind of pattern ORO suggested would maximize the probability of a hit.

Although at the time the Infantry Board saw the SPIW proposal as nothing more than a clever bureaucratic foil to deflect attention from the ARL5, it also represented the service's official admission that marksmanship principles were no longer valid. The SPIW's range was to be no more than 400 yards, much less than the range of a marksman's rifle. And it would fire three projectiles, not that one well-aimed bullet the marksman was trained to fire. Bureaucratic foil it may have been in part. It was also the Ordnance Department's and the Army Staff's way of dealing with the need for change at a pace more comfortable to the organization as a whole.<sup>69</sup>

In the months after the Infantry Board sent its recommendation up through the Army Staff, there transpired a nasty controversy over the ARL5's technical merits. The debate pitted the Ordnance Department against CONARC and more specifically the Infantry Board; this controversy never rocked the service as a whole. Nonetheless, selecting the ARL5 over the M14 promised to have serious repercussions. Partly for this reason, and partly because he thought the M14 a perfectly acceptable weapon,<sup>70</sup> Army Chief of Staff Maxwell Taylor took the SPIW option. In February 1959 he announced that the ARL5 did not represent enough of a forward advance in rifle design to merit its selection over the M14. Hence, the Army would buy the M14, as it had intended, and begin work on a real "leap forward" in small-arms design, the SPIW. Almost as quickly as it had arisen, the first rifle controversy disappeared, as both the Infantry Board and the Ordnance Department took Taylor's marching orders and fell into line.<sup>71</sup>

Taylor's decision put a rapid end to this first ARL5 controversy, but, of course, could not put an end to the organizational

fragmentation that gave birth to the ARL5 in the first place. Still, Taylor's decision tended to be a very binding one. On the one hand, it inaugurated production and distribution of the M14, thus increasing the momentum behind that weapon. On the other hand, it focused the Army's small-arms experts and their research money on the development of the radically innovative SPIW, to the exclusion of less exotic weapons like the ARL5. Taylor himself may have enjoyed very little flexibility in facing the first ARL5 controversy. His solution to that controversy created a still more inflexible situation for the years to come.

V. ROBERT MCNAMARA AND THE SECOND RIFLE CONTROVERSY

The origins of the second rifle controversy lay in the first. At the Infantry Board's request, Eugene Stoner designed and built the AR15. The service thereupon denied that rifle a market. In their efforts to find another market, the rifle's commercial proponents brought the AR15 to the attention of Defense Secretary Robert McNamara. And McNamara tried in his own way to do what the Infantry Board had tried to do before him.

Stoner had been working for Armalite, a subdivision of Fairchild Aircraft and Engine Company, when he built the first AR15 prototypes. Although Armalite had no production facilities, by the time Maxwell Taylor diverted the Army's interest away from the AR15, a "finders" firm called Cooper-Macdonald, Inc., had interested Colt's Firearms in producing both the AR15 and its antecedent, the caliber .30 AR10. Between 1958 and 1960, Colt's and Fairchild worked out a production agreement.<sup>72</sup> Both rifles thus found a producer at about the same time that they lost their potential U.S. Army market.

Having found a producer for the weapons, Cooper-Macdonald set about finding another market as well. In the spring of 1959 representatives from that firm took both the AR10 and the AR15 on a sweeping promotional tour to some ten Southeast Asian nations, many of them allied in some way with the U.S.<sup>73</sup> The trip taught them two lessons. First, the United States' "smaller-statured Asian allies" were wildly enthusiastic about the AR15. Normally, these allies received either M-1s or M-2 carbines as part of the U.S. military assistance effort. The AR15 was easier for them to handle than the M-1, and much more effective than the M-2. In the Philippines, however, Cooper-Macdonald's representatives learned that for logistics reasons the U.S. generally did not permit nations with which it had a military assistance agreement to buy weapons that were not standard items from the U.S. military inventory. These businessmen thus returned from their promotional tour convinced that the AR15 was the rifle to sell, that Asia was the place to sell it, but that they needed to sell the piece to a U.S. military service before the Asian market could be tapped.

The U.S. Army may not have been interested in the rifle, but the Air Force was. Armalite's president was a personal friend of General Curtis LeMay, the Air Force Deputy Chief of Staff. He knew that LeMay took a strong personal interest in small-arms and was in fact a big-game hunter and gun buff of some reknown. He also knew that the Air Force's rather small rifle inventory of M-2 carbines—used to arm base security guards, for the most part—was getting old. The Army, which remained the Defense Department's sole procurement agent for rifles, wanted to replace these aging carbines with the new M14. Anxious to give his troops a rifle capable of automatic fire, however, LeMay wanted no part of the M14. After a demonstration of the AR15's capabilities given him at a 4th of July picnic in 1960, LeMay decided that the little plastic rifle was exactly what he wanted.<sup>74</sup>

This put LeMay at odds with the Army. For the Air Force had to get the *Army* to buy the new rifle for it. From the Army's perspective, however, doing so meant adding another kind of rifle ammunition to an inventory the service consistently had sought to focus on one caliber .30 round. Besides, it also tacitly endorsed a rifle the Army had turned away not two years before. Although the service retested the AR15 at LeMay's request, it opposed his buying the rifle just as ardently as LeMay himself pushed the idea.<sup>75</sup> Indeed, this argument went all the way to the President; in October 1961 John Kennedy personally told LeMay, who was by now the Air Force Chief of Staff, to stop badgering the Army about the AR15.<sup>76</sup>

Though unsuccessful, LeMay's attempt to buy the AR15 gave the rifle high visibility in the government. And the fact was that the kind of arguments LeMay and Cooper-Macdonald were making on the rifle's behalf were finding sympathetic listeners in the Kennedy Administration because of Kennedy's avowed interest in counterinsurgency warfare. Thus, at the same time that Kennedy himself told LeMay to drop the idea of buying AR15s, the Defense Department's Advanced Research Projects Agency (ARPA) asked permission to test the rifle's effectiveness in the Republic of Vietnam.<sup>77</sup> Over the Army's objections, Secretary of Defense McNamara granted ARPA its wish. In January 1962 ARPA shipped 1000 AR15s to Saigon for six months of field tests in the hands of Vietnamese soldiers and their U.S. advisors.

The ARPA tests proved to be the decisive turning point in the AR15's fortunes. Even before ARPA published its highly laudatory final report in July 1962, rumors of the rifle's apparently amazing capabilities began filtering back from Vietnam. In particular, the AR15's lethality left test participants astounded. Its relatively small bullet tended to turn end-over-end—"tumble"—when it hit a target. It thus created grisly and highly lethal wounds.<sup>78</sup> Beyond this, the rifle had all the advantages normally associated with light-weight assault rifles. The ARPA test report found it decidedly superior to the other rifles then in use in Vietnam.

Interest in the AR15 now mushroomed. In May 1962 General LeMay asked once again for his initial shipment of AR15s, and this time received approval for his request.<sup>79</sup> Also in May, the Navy announced its decision to equip its Sea-Air Land (SEAL) teams with the rifle.<sup>80</sup> And over the summer General Harkins, commanding the nation's effort in the Republic of Vietnam, put in his order for some 20,000 AR15s to equip Vietnamese units and their advisors.<sup>81</sup>

Most important, in July a small group of systems analysts in the Office of the Secretary of Defense (OSD) began work on an elaborate rifle study that found the AR15 "decidedly superior" in most important respects to the M14 and M-1. In no respect did it find the M14 superior; indeed, these analysts found the M14 inferior even to the Soviet Union's AK-47. Significantly, although ARPA's interest in the AR15 had derived ostensibly from the rifle's usefulness to the nation's smaller-statured allies, this analysis made no such qualifications, calling the AR15 "the superior weapon" in the broadest terms. The report went to Charles Hitch, McNamara's Controller, and thence to McNamara himself. It became known thereafter as the Hitch Report.<sup>82</sup>

At the time, the NATO standardization agreement created the same problems for McNamara and his staff that it had created for Maxwell Taylor. Simply dropping the M14 and its 7.62mm NATO cartridge meant violating an international agreement. Thus, in discussing the Hitch Report with members of the Army Staff, Alain Enthoven, McNamara's chief systems analyst, phrased his arguments

in terms of the new rifle's suitability for counterinsurgency warfare. Enthoven hoped to see the Army buy limited quantities of the AR15, thereby getting it into the service's inventory and out to soldiers who could test its capabilities on a scale wider than that of the ARPA tests. He assumed that at some future point the rifle's suitability as the service's *only* rifle could be considered in earnest.<sup>83</sup>

Limited though OSD's goals were, the Army Staff opposed the idea. It saw no utility in splitting the Army's rifle inventory between two weapons—the AR15 and the M14—of different caliber and capability. The soldier's rifle, it argued, should "be adaptable to the American soldier anywhere in the world."<sup>84</sup> It continued to see the M14 as the better weapon, partly because that rifle fired the NATO cartridge but also because it outperformed the AR15 "at ranges in excess of 400 meters"<sup>85</sup>—ranges the Army Staff apparently considered important. Most of all, no one in the Army Staff or the Ordnance Department thought the AR15 could be fully readied for production much before 1964. Thus they preferred retaining the M14 and waiting on the SPIW's development, which, they announced, would be completed by 1965.

McNamara himself now brought the widening debate touched off by General LeMay in 1960 to its climax. In a curt memo to the service dated October 12, 1962, McNamara noted the existence of "certain evidence [the Hitch Report]" which indicated that "we are equipping our forces with a weapon [the M14] decidedly inferior...to the [Soviet] assault rifle." McNamara further suggested that the AR15 was "markedly superior [to the M14]...in every respect of importance to military operations...." He asked for the Army's views and recommendations on the subject.<sup>86</sup> A few weeks later, the President himself was briefed on the issue, after which Kennedy queried McNamara much as the Defense Secretary had questioned the service. In response, McNamara asked the service for a reply to his query by the end of January 1963.<sup>87</sup> The rifle issue was thus posed in the broadest terms possible, before a wide and politically important audience, and with a deadline that forced the service into action.

This left Army Chief of Staff Earl Wheeler with little room for maneuver. All evidence suggests that Wheeler himself was quite flexible on this issue.<sup>88</sup> But his organization was not. The M14 had entered production in 1960 and by 1962 was being distributed to infantrymen. As was normally the case with a new weapon, its distribution was accompanied by repeated claims that it was the best rifle in the world. The three months between October 1962 and January 1963 left little time to slow or reverse the momentum behind that rifle. At the same time, the Army Staff and the Ordnance Department, both of which had been fighting a rearguard action against the AR15 since 1960, could hardly be expected to reverse themselves at McNamara's behest. Finally, Wheeler had to consider the precedent of the thing; McNamara was trying to tamper with Army rifle procurement, and no Chief of Staff could feel completely comfortable giving way on an issue that the Army liked to think was strictly its own concern.

Wheeler decided to run both the AR15 and the M14 through a massive series of "world-wide" tests at posts located in the U.S., Europe, the Carriibbean, and Alaska. In view of the fact that the two rifles had been tested and compared before in a variety of environments, the tests seem to have been technically unnecessary. They did solve Wheeler's organizational problem, however, by promising to give the AR15 a degree of visibility in the service at large that the rifle sorely lacked. In some part, the tests represented Wheeler's effort to create an organizational constituency for the AR15.

Unfortunately, the tests proved disastrous. Wheeler simply lacked the time to set up firing ranges for comparative firings, or to get the AR15s distributed to each post. Most of all, under the circumstances neither he nor his chief subordinates could fully control so massive an undertaking. Under way by the end of October 1962, the tests bogged down in a furious controversy by December, when Colt's and Cooper-Macdonald as well as members of McNamara's staff accused the Army of bias and outright cheating in its efforts to defend the M14. Secretary of the Army Cyrus Vance immediately ordered an investigation of the charges, which produced virtually

nothing,<sup>89</sup> but which at the time cast a pall over the test results. That these results generally favored the M14 was thus of no consequence; by the time those results were in, they were too thoroughly discredited to provide an acceptable rationale for Wheeler's decision.

Wheeler and Vance thus reached a compromise. On January 14, 1963 Wheeler announced the Army's intention to buy from 50 to 100 thousand AR15s for its Air Assault, Airborne and Special Forces units, to reduce M14 procurement accordingly, and to continue work on the SPIW. This satisfied McNamara's desire to get the weapon into the service's inventory, while it quieted a controversy that, if pushed further, might have raised thorny constitutional issues. And it saved face for the Army by implicitly endorsing the M14. Indeed, while the service reassured its soldiers that the M14 remained "the standard rifle for infantry, mechanized and armor division," it also made clear that buying the AR15 was strictly a one-time thing.<sup>90</sup> Finally, because the units due to receive the new rifle were stationed outside Europe, the compromise left intact the NATO standardization agreement. The decision may have lacked intellectual elegance in terms of the arguments OSD and the Army had made for and against the new weapon, but it had both political and organizational merit.

Wheeler's decision put an end to the hue and cry that had surrounded this second AR15 controversy. But it failed to put an end to the controversy itself. For Wheeler's decision had to be implemented, and before Colt's Firearms could be given a production contract, the rifle's final development had to be completed. McNamara created a special task force, the Technical Coordinating Committee (TCC) to manage this process.<sup>91</sup> But only one group of technical experts was available to handle the actual technical work—the Army's small-arms experts, whom McNamara had just alienated by forcing Wheeler's decision. In the months after Wheeler announced that decision, McNamara learned that forcing a decision was easier than forcing its implementation. The rifle controversy continued, albeit more diplomatically, as McNamara and the service argued about the weapon's technical development.



The debate revolved around over 130 proposed changes in the rifle's design and construction that confronted the TCC soon after it convened. Some of these changes were minor, including several that suggested using different metals or metal processing techniques for various of the rifle's parts in order to make them last longer. Others, however, involved significant changes in the rifle's basic design, including an Army proposal to add a "bolt closure device" to the rifle's breech that would allow soldiers to close the bolt manually in an emergency. Because none of the other services buying the rifle saw a need for the device, this proposal threatened to make the Army's rifle unique, something McNamara wanted to avoid.

Although proposals like these threatened to delay or possibly prevent the rifle's actual purchase, McNamara and his staff lacked the expertise and the resources to force these technical issues as they had the political and analytical issues that arose earlier in the controversy. To be sure, they could and did intervene to settle unresolved technical debates, but this led to almost absurd extremes. When the Army and the Marine Corps seemed unable to agree on a specific trigger-pull pressure for the rifle, for example, OSD stepped in to force agreement.<sup>92</sup> And an assistant secretary of defense finally made the decision as to how tightly the grooves in the rifle's barrel would be twisted.<sup>93</sup> In making such decisions, OSD often operated beyond the limits of its expertise as well as its charter. For the most part, these analysts simply had to wait while the TCC labored over the merits of each proposed change.

The technical portion of the second ARL5 controversy reached its climax in the fall of 1963. In September the Army Staff suggested for one last time that the ARL5's technical problems made it "an unsatisfactory weapon for Army procurement and use."<sup>94</sup> Countering, McNamara not only ignored the suggestion but announced his intention to terminate M14 production at the end of the year, a move that would leave the Army with just enough M14s to arm its active units but not so many in stock as to weight the choice of a future rifle heavily in its favor.<sup>95</sup> Meanwhile, Secretary of the Army Vance began negotiating a series of compromises on the remaining technical

issues, the last and most important of which was the bolt-closure device issue.<sup>96</sup> With McNamara's acceptance of the Army's position on this issue, the way was finally cleared for production, and in November 1963 the Army finally ordered 85,000 copies of the new rifle, to be called the M16A1 (the "A1" signifying the addition of the bolt-closure device; other services ordered the M16, without the device).

The second rifle controversy thus dragged on for nearly a year after General Wheeler announced his decision to buy the AR15. Nonetheless, with the production contract finally let, McNamara could take some satisfaction in having forced open the service's rifle procurement options for perhaps the first time in the postwar era. M16s would ultimately go to units where their performance and popularity could be judged more accurately and objectively than had been the case during the world-wide tests. Meanwhile, M14 production would halt at the end of the year, leaving that rifle available but not abundantly so. Finally, work on the SPIW continued, holding out promise of a weapon far superior to either of the rifles that had just been the subject of hot debate.<sup>97</sup>

VI. THE WAR, THE ORGANIZATION, AND THE M16

McNamara's sense that he had opened the Army's rifle procurement options was not shared by members of the Army Staff, who remained wedded to the position they had held all along. That late in 1966 the M16 nonetheless became the Army's standard rifle bore witness to the workings of forces not entirely under the control of either McNamara or the Army Staff. On the one hand, politics within the Defense Department worked to force a decision on the rifle issue sooner than had been expected. On the other hand, the organization's response to combat in Vietnam gently pushed that decision in the M16's direction. McNamara had laid the basis for this major change in the Army's rifle inventory when he forced the M16's purchase in 1962. Thereafter, the issue was resolved in a way that neither he nor his chief antagonists on the Army Staff completely controlled.

Nothing members of the Army Staff said or did after 1963 suggested that they saw their rifle procurement options quite the way McNamara saw them. The Deputy Chief of Staff for Logistics put the matter bluntly in 1964:

For the past several years we have *fought off* any solution [to the rifle problem] which would commit the Army to another interim weapon which could hinder the development of a greatly improved individual weapon [the SPIW] in the 1965-70 time frame.<sup>98</sup>

Thus the Staff made no plans to buy more M16s or replace those M16s of the initial buy as they wore out. Indeed, in official Army parlance the M16A1 continued to be referred to as the "XM16E1" to denote its experimental, impermanent status. The M14 remained the service's standard rifle, the SPIW its only legitimate successor.

This position might have been more viable had the SPIW been more amenable to development. It was not. Prototypes of the SPIW that appeared in 1963 and 1964 suffered from a variety of serious

technical problems.<sup>99</sup> In addition, the weapon's developers could not find a cheap and efficient way to mass-produce the SPIW's flechette ammunition.<sup>100</sup> Expected completion for the SPIW's development thus drifted off into the future. In 1959 the Ordnance Department had promised the Infantry an SPIW of some sort by 1962. Yet in 1963 the completion date for the weapon's development had been set back to 1965. And in 1964 the date was reset for 1967. Whether members of the Army Staff sincerely wanted to see the weapon developed or simply used it to keep McNamara and the M16 at bay,<sup>101</sup> the rifle's technical problems were making their position a tenuous one.

What these staff members needed was time to see the SPIW's development completed, yet time was precisely what they were denied. For in 1964 the U.S. Marine Corps reopened the rifle debate in a way that was destined to force a decision on the issue *before* the SPIW could be developed. For the Marine Corps, and especially its Commandant, General Wallace Greene, McNamara's interest in rifles opened intriguing possibilities. Like the Air Force, the Corps purchased its rifles through the Army, and thus normally took what the Army gave it. Yet Greene liked neither the M14 nor the M16. Instead, he was attracted to the "Stoner-63" system, yet another caliber .223 rifle developed by the inventive Eugene Stoner. Stoner had constructed this weapon for Cadillac-Gage, Inc., a firm to which he had migrated in 1960, when the fortunes of both Armalite and the AR15 had reached a low ebb.<sup>102</sup> The Stoner-63, or "Stoner-Family" as it was sometimes called, was actually a set of interchangeable components that could be used to construct a family of weapons, from a carbine to a belt-fed machinegun. This gave it logistics advantages of special appeal to the Marine Corps, which liked to minimize its dependence on the logistics support of other services. With McNamara forcing open the Army's rifle procurement options, General Greene saw a chance of opening the Corps' options as well. Thus, in the summer of 1964 Greene began briefing key members of McNamara's staff and the Army itself on the Stoner-63's merits.<sup>103</sup>

Although the Army Staff hardly wanted yet another rifle brought to its attention, Greene's activities forced it to action. In

September 1964 Marine Corps briefers told the Deputy Secretary of Defense that "the Army has a closed mind on the Stoner system and has been dragging its feet."<sup>104</sup> This brought pressure to bear on General Harold Johnson, who had replaced General Wheeler as Army Chief of Staff earlier that year. To head off a confrontation and in hopes of finally settling the rifle issue, Johnson proposed a major evaluation of Army small-arms. Called the "Small-Arms Weapons System (SAWS) Study," the evaluation encompassed a review of Army rifle doctrine, technical and field tests of a variety of available small-arms, and a computerized combat simulation designed to test a wide range of potential rifle capabilities. Tested weapons included the M16, Stoner-63, M14, AF47, and other commercially-produced caliber .30 and caliber .223 systems, as well as the SPIW. Beginning late in 1964, the SAWS Study was scheduled for completion by mid-1966.<sup>105</sup>

Although it represented an ambitious and praiseworthy undertaking, the SAWS Study could not have been more badly timed from the Army Staff's perspective. For the SPIW could not be made available for technical or field testing. Only the computerized combat simulation could take account of the SPIW by using the weapon's projected characteristics in its program. Whether or not the SPIW ever would have been ready for field testing remains a debatable issue to this day.<sup>106</sup> But in 1965 it clearly was *not* ready, and the major portion of the SAWS Study focused instead on rifles available as actual hardware.

Nonetheless, the Army Staff found in the SAWS Study confirmation of its long-standing position on the rifle issue. Basing its findings largely on the computer simulation, the Staff argued that the SPIW "consistently ranked higher than any other rifle in the study."<sup>107</sup> In the fall of 1966 the Staff passed its recommendation to the Chief of Staff: M16 procurement should be continued in limited quantities sufficient to maintain stocks; an M14 production capability should be kept in existence in case a mid- to high-intensity war were to break out; and major emphasis should be placed on completing the SPIW's development.<sup>108</sup>

But the Army Staff was not the only agency charged with reviewing the SAWS data. By the summer of 1966 a new group of systems

analysts, the "Force Planning and Analysis Office," had taken a place at the Army Staff level. Created largely at the behest of McNamara and his staff, this part military, part civilian agency had been created to give the Army itself a systems analysis capability like that found on McNamara's staff.<sup>109</sup> Although not formally a part of the Army Staff, it reported to both the Chief of Staff and the Secretary of the Army. Aware that the rifle issue remained a volatile one, General Johnson and Secretary of the Army Stanley Resor agreed to allow this agency, as well as the Army Staff, to do an analysis of the SAWS data.

The Force Planning and Analysis Office took precisely the opposite approach to the study as that taken by the Army Staff. Where the Staff had rested its analysis chiefly on the computer simulation, analysts in the Force Planning and Analysis Office condemned that portion of the study as incapable of sufficient discrimination to detect subtle differences between various kinds of rifles. Where the staff had lauded the SPIW, the analysts contended that the SPIW might never work, and would probably be too expensive in any case. They based their own conclusions primarily on field tests of the rifle squad maneuvers conducted under simulated combat conditions. These tests showed that, as a class, caliber .223 rifles like the M16 were much more effective than the larger caliber .30 weapons. And because it was lighter than the Stoner-63 rifle, the M16 proved the better squad weapon. Thus, the Force Planning and Analysis Office recommended that the Army place the SPIW in a low-key, long-term research program, drop the M14 entirely, and focus all rifle procurement on the M16.<sup>110</sup>

The conflicting analyses presented them by the Army Staff and the Force Planning and Analysis Office placed Resor and Johnson in a situation much like the one facing General Wheeler in 1962. The Army Staff's position on the rifle issue had not changed since then; indeed, it had not changed since 1959, when the first AR15 controversy had ended. And in 1966, as in 1962, arguments in the M16's favor came from essentially "foreign" groups of analysts outside the service mainstream. In both cases the Chief of Staff would

have had to disavow his staff, as well as most of the Army's technical community to decide in the M16's favor.

But if in this sense the two situations were similar, they nonetheless differed in one key way. In 1962 the AR15 had been a new and strange-looking invention lacking visibility, not to mention popularity, in the service as a whole. By 1966, on the other hand, the M16s purchased in 1963 had helped create a considerable following for the weapon among the U.S. infantrymen who had begun entering combat in Vietnam after March 1965. The Army Staff's position had not changed, but it had become less than relevant to the combat needs sensed by soldiers fighting in Vietnam.

The fact was that the M16 provided capabilities eminently suited to jungle fighting that were not provided by other available weapons. Marksmanship, and hence the M14, had little role to play in the jungle. Rather, this kind of terrain favored automatic weapons like the Soviet AK-47, which the Viet Cong began receiving from the Soviet Union in 1964.<sup>111</sup> U.S. advisors and, after March 1965, U.S. Marine and Army units, thus found themselves outgunned by their adversary, at least in the small-arms realm. Among the first U.S. Army units to enter Vietnam in 1965, however, were those "special" units that had received the M16s that comprised General Wheeler's original purchase. Members of these units found the weapon perfectly suited to their needs; lighter and more lethal than the AK-47 or the M14. Indeed, in these first months of its exposure in Vietnam, the M16 earned a widespread reputation as a miracle weapon.<sup>112</sup>

General William C. Westmoreland, commander of the U.S. effort in Vietnam, realized that the AK-47 gave the Viet Cong an advantage in small-arms firepower over his own forces armed with the M14. He also realized that the M16 might solve this problem, though he hesitated to ask for major additional purchases of the rifle until it had been truly tested in combat. By October 1965, however, the rifle's undisputed effectiveness in major engagements had convinced him of the need to arm all troops, U.S., Vietnamese, and Korean alike, with the M16.<sup>113</sup> In December 1965 Westmoreland fired off an urgent cable to the Chief of Staff requesting purchase of some 170,000 additional M16s for U.S. forces in Vietnam.<sup>114</sup>

Westmoreland's cable took the Defense Department by surprise. In the months before it arrived a few high ranking Army officers had suggested that additional purchases of the M16 might be in order. The Army Staff as a whole, however, failed to take these suggestions seriously, partly out of fear that such purchases might amount to a "prejudgment" of the ongoing SAWS Study.<sup>115</sup> In addition, McNamara himself shied away from the financial and logistics burden associated with a full commitment to the M16's use in Vietnam.<sup>116</sup> No one in the Defense Department took steps to prepare Colt's Firearms for an increase in M16 production.

The day after the cable arrived a telephone order to Colt's Firearms stepped up production there to meet the new demand. Whether because at the time few foresaw the scope and duration of the Vietnam conflict or because no one wanted to prejudge the SAWS Study, this telephone order possessed little of the urgency with which Westmoreland had dispatched his cable. No action was taken, for example, to find a second producer for the rifle, nor did the production increase fully tax Colt's facilities.<sup>117</sup>

To the extent that this lack of urgency was meant to forestall a "prejudgment" of the SAWS tests, it had some effect. Total M16 purchases of less than 300,000 fell far short of the total number of M14s then in stock. And it came nowhere near the several million rifles normally associated with a full-scale commitment to one rifle. In terms of the investment sunk into both rifles, there was no particular reason to go with either one.

Still, events in Vietnam did influence Resor and Johnson as they sought to reach a decision concerning the Army's future rifle inventory. For Resor, in fact, the M16's popularity in Vietnam combined with the growing logistics momentum behind that weapon were decisive; Resor saw a good deal of logic in "volume of fire" approaches to the rifle issue, and felt that the Army's Vietnam experience merely validated that point of view.<sup>118</sup> For Johnson, on the other hand, the rifle's popularity eased the organizational problem that General Wheeler had faced four years earlier. And this left Johnson free to make any decision he cared to make.<sup>119</sup>



As it happened, Johnson favored the analysis provided by the Force Planning and Analysis Office. The Chief of Staff considered the SPIW a Rube Goldberg device of questionable value and reliability, and he was quick to spot the flaws inherent in the computerized portion of the SAWS Study, the only portion that had favored the SPIW. Finally, Johnson was impressed with the results of field testing in simulated combat situations, and on these tests the M16 had proved itself most capable.<sup>120</sup> Johnson thus settled on the M16.

In December 1966 Resor and Johnson officially announced their conclusion that:

- a. The XM16E1 [M16] rifle is generally superior for Army combat use.
- b. The current SPIW program is unlikely to result in a satisfactory competitive weapon as early as previously forecast.<sup>121</sup>

They therefore recommended to the Secretary of Defense that Army rifle procurement "in the foreseeable future should be limited to the XM16E1," that in the long run all M14s should be replaced, and that the SPIW should be placed in a long-term research program. It was in every way a radical departure, a complete reorientation of the Army's small-arms inventory around a new cartridge as well as a new rifle.

Ironically, it was now McNamara's turn to feel pressured for a decision on the rifle issue. Though it seems clear that the Defense Secretary favored the M16, at the time the nation's growing involvement in Vietnam was absorbing increasing amounts of his defense budget, and he was less than anxious to take on the sizable financial commitment entailed by full standardization of the M16. Nor was he comfortable with the fact that the decision violated the NATO standardization agreement, not due to expire until 1968. Rather than approve the decision, McNamara returned it to Resor and Johnson with a request for more study and analysis.

At the same time, the M16's popularity in Vietnam suddenly plummeted as soldiers began to experience serious malfunctioning with

their new M16s. Within weeks after Johnson and Resor announced their decision to standardize the rifle, reports of its tendency to jam had become the subject of critical television and news reporting in the United States, and the cause of a major loss of confidence in the rifle among U.S. soldiers in Vietnam. Ultimately, the rifle's technical problems produced a *third* rifle controversy, one that remains the most notorious of the three that surrounded the M16. Indeed, moved in large part by the public outcry, the House Armed Services Committee began an extended investigation into the rifle's development and purchase.<sup>122</sup> To this day, many remember the M16 as the rifle that jammed in Vietnam. Yet the sources of the rifle's problems had been eliminated even before the Congress began its investigation, and by 1968 the rifle's reliability returned to the high level it had evinced during early tests.<sup>123</sup>

Neither reports of the rifle's technical problems nor McNamara's reluctance to approve the rifle's standardization altered Resor and Johnson's original decision, however. Convinced that the rifle's problems were temporary and on the way to being solved, both individuals stood by the basic outlines of their decision. They agreed, however, to delay standardizing the rifle for U.S. soldiers stationed in Europe until after the NATO cartridge standardization agreement had expired in 1968. Thus, the M16's standardization took place in two phases, one in 1967 involving all but U.S. forces in Europe, and one a year later that completed the process. By the end of 1968, the M16 had truly become the standard small-arm of all U.S. forces.<sup>124</sup>

The M16's ultimate disposition only bore out the analytical case McNamara had touted so loudly during the second AR15 controversy. Yet it should be clear that events McNamara could not control also alleviated the one aspect of the problem he could never handle. It was the organizational dimension of the rifle issue that constrained McNamara's efforts to see the rifle purchased in 1962. There was no way to get around it; indeed, in pushing the issue as hard as he did, McNamara only boxed Chief of Staff Earl Wheeler more tightly into a corner, leaving him with little room or time to maneuver

inside his own organization. Thereafter, events in Vietnam slowly reoriented these organizational forces in a way that left the next Chief of Staff free to decide the issue in a way Wheeler could never have chosen. McNamara himself may have set the stage for all of this. Events not entirely under his control carried the logic of his position through to completion.

VII. ORGANIZATIONAL COMPLEXITIES

By all rights the M16's standardization represented a notably successful case of weapons innovation. A traditional weapon possessing capabilities that for years had been growing less relevant to evolving combat conditions was replaced by one better able to serve the infantry soldier's needs. The M16 to this day remains the shoulder weapon for virtually all active U.S. forces and reserve components. Army stocks of the weapon total more than 1.4 million copies of the piece. The Defense Secretary may not have exercised complete control over the M16's adoption, but the rifle nonetheless achieved a disposition in the U.S. Army's inventory fully commensurate with the analytical case on which he had based his decision to have it procured.

Moreover, if on the one hand McNamara cannot be said to have controlled the process of innovation, neither did success come via the sort of "dramatic performance failure" that so often ushers innovative weaponry into the inventories of otherwise resistant military services. To be sure, the Vietnam War provided a well-timed if purely fortuitous push to the rifle's fortunes. But in 1966 that war was neither so massive an undertaking in organizational terms (the Army still had its eyes primarily on European warfare) nor the rifle's role in it so crucial as to have caused "dramatic" failure. Rather, the early stages of that war might more rightly be said to have demonstrated the M16's dramatically superior performance compared to other available small-arms. By so doing, the war helped loosen the grip of tradition on the service sufficiently to allow Chief of Staff Harold Johnson the freedom to decide the issue any way he chose.

Something less than dramatic failure could loosen the grip of tradition in this case because that grip was not as tight as was indicated by the M14's traditional capabilities, or the Army Staff's hostility to the M16. The persistently traditional characteristics of U.S. Army rifles developed in the twentieth century,

and the equally persistent official pronouncements of marksmanship's utility that accompanied their introduction, masked an increasing amount of organizational fragmentation around the rifle issue. In twentieth century warfare U.S. infantrymen sensed the need for new rifle capabilities and the inadequacy of traditional doctrine. The nearly unanimous coalition of organizational interests that supported marksmanship doctrine in the latter half of the nineteenth century began to break down. Organization policy did not fully reflect organizational consensus.

The effect of this fragmentation can be seen in the adaptive processes that led to the M-1 rifle, one that combined traditional and newer capabilities. It is even more visible in the technically impractical but organizationally responsive rifle requirement written in the wake of World War II. Above all, to this fragmentation can be traced the origins of the M16 itself, as well as the forces that augered for its adoption. Reference to the marksmanship tradition may explain the capabilities of the M-1 and the M14. Only reference to the declining organizational consensus around that tradition can explain the rest of the M16 story.

The story thus suggests that large organizations may be more complex and heterogeneous than the common notion of a monolithic, ponderous beast implies. Organizational policy may be less the result of a coherent effort to pursue traditional goals as the product of bargaining, tacit or explicit, among organizational sub-components with competing, or at least less than complementary, goals.<sup>125</sup> Just as the M14's development masked the existence of growing interest within the service in more tactically useful kinds of rifle capabilities, organizations may be closer to reality than their policies indicate. And to the extent that this is true, organizations may be capable of more flexibility and adaptability than observers—or defense managers—expect.

Policymakers face the twin problems of discovering the degree of organizational fragmentation on any given issue and of trying to tap the flexibility implied by its existence. The M16 case suggests that a strong analytical case will not alone help solve

either problem. The Hitch Report represented a comprehensive and provocative study of the rifle problem. But it was the M16's actual performance that won it the popularity that helped usher in its adoption. McNamara may have needed the Hitch Report to convince him that action was justified; he helped usher in the M16's adoption by forcing the rifle into the service itself, where the weapon's demonstrated capabilities gradually won it a constituency. Innovative hardware in the right place at the right time—and few can predict these places and times in advance—seems better able than the written word to enlist the overt support of organizational sub-units that favor the capabilities it offers.

That the Vietnam War helped push the organization toward the M16 suggests that the organization's environment "speaks" to it more loudly than analysis. Indeed, the tendency of combat to provoke internal debate over the rifle issue throughout the twentieth century bears witness to the fact that events that touch the organization at all levels influence it more dramatically than arguments voiced at the pinnacle of the organizational hierarchy. This suggests that the desire to tap the organization's flexibility may be well served by manipulating its environment. The Secretary of Defense may never be able to do this in a way that touches the organization quite as intimately as does warfare itself. Nonetheless, he is part of the organization's environment, controlling as he does its budgets—to some extent—and its assigned roles and missions—within limits. And he is himself a powerful ally to organizational sub-units whose ideas mesh with his own. The M16 case supports the notion that bargaining and competition within the Defense Department may be used as effective managerial tools.<sup>126</sup>

Still, the case does not suggest that the prospects for innovation can be entirely freed from organizational processes beyond the control of the most astute defense manager. Thus, while it suggests a certain amount of flexibility in large organizations, the case also posts an overriding cautionary note. Analysis must come to terms with the organizational dimension of the weapons acquisition process, and that might well involve a complex interaction

between the organization and its environment whose outcome can neither be fully predicted nor completely controlled.

NOTES

1. See Graham Allison, *Essence of Decision* (Boston: Little, Brown and Company, 1971), p. 85.
2. Although the M16 controversy made the newspapers, it was overshadowed by reports on the contemporaneous TFX (F-111) controversy, which accounts, perhaps, for its relative lack of visibility.
3. J. F. C. Fuller, *The Conduct of War, 1789-1961* (London: Eyre Mathuen, 1972), pp. 104-105.
4. To be sure, rifles were around for some decades before 1850; the Kentucky Rifle became famous even before the American Revolution. But these early muzzle-loading rifles fired a lead ball that had to be forced down the rifle's barrel, often with the aid of a mallet, to ensure that the ball fit tightly into the grooves. These rifles were used only by experts, until about the middle of the century, by which time French ballisticians had perfected the expanding bullet, which fit loosely into the barrel but then expanded once the powder was detonated. The U.S. Army standardized a "rifle-musket" firing an expanding bullet in 1855.

Breechloading rifles eliminated these loading problems; the ball was loaded into the breech end of the rifle, where the detonating powder would force it into the grooves. Although there were several kinds of breechloaders available in the first half of the nineteenth century, because these used loose powder or paper cartridges they generally leaked fire and gas when fired. Metallic cartridges solved this problem by expanding to seal the breech when the powder in them detonated. The first metallic cartridge appeared in 1851 (in the United States), but the U.S. Army did not adopt a breechloader using such a round until after the Civil War. See Charles W. Sawyer, *Firearms in American History, Volume III* (Boston: The Cornhill Company, 1920), *supra*.
5. See Major Gerald Gilbert, *The Evolution of Tactics* (London: Hugh Rees, Ltd., 1907), pp. 149-150 and Fuller, *The Conduct of War*, pp. 88-90.
6. Jac Weller, *Weapons and Tactics* (London: Nicholas Vane, 1966), p. 77.
7. I refer here to the Austro-Prussian (1866) and Franco-Prussian (1870) wars, during which combatants armed with breechloaders often took their adversaries under fire at ranges in excess of 1000 meters. See Fuller, *The Conduct of War*, pp. 88-90. See also W. H. B. Smith, *Small Arms of the World* (Harrisburg: The Stackpole Company, 1962), p. 63, for an account of how the Turks defending Plevna in 1877 took their Russian attackers under effective fire at ranges of 2200 yards.



8. Cpt. R. O. Horn, "Fire Discipline, Control and Direction", *Infantry Journal*, January - February 1913, pp. 486-487.
9. *Ibid.*
10. See Cpt. J. S. Switzer, "The Department of Experiment, Infantry School", *Infantry Journal*, March 1921, pp. 219-224, for a brief history of the Army's School of Musketry.
11. The two most important of these texts were Col. T. T. S. Laidley's *Course of Instruction in Rifle Firing*, (Philadelphia: J. B. Lippincott and Company, 1879), and Cpt. Stanhope E. Blunt's *Firing Regulations for Small Arms for the US Army* (New York: Charles Scribner's Sons, 1889). Laidley specified target practice to ranges of 1200 yards.
12. Cpt. William M. Wright, "Rifle Firing and the National Rifle Competition," *Journal of the US Infantry Association*, October 1904, p. 76.
13. Cpt. H. C. Hale, "New Firing Regulations for Small Arms," *Journal of the US Infantry Association*, July 1904, p. 14.
14. These words are contained in General S. V. Benet's introduction to Blunt's *Firing Regulations*, p. v.
15. "The pages of *Infantry Journal* and *Journal of the US Infantry Association* published during the early years of this century abound with articles referring to the National Matches and the service's painstaking preparation for them. Selecting the Army team, for example, took about half of the training years, and those soldiers who finally made the team were accorded considerable prestige. For an exemplary article, see Wright, "Rifle Firing and the National Rifle Competition."
16. Ammunition waste was for years the chief argument lodged against weapons that fired more rapidly than those already in service. For an extreme example of an argument favoring muzzle- over breech-loading weapons on these grounds, see Francis J. Lippitt's *A Treatise on the Tactical Use of the Three Arms* (New York: D. Van Nostrand, 1865), especially p. 45. This remained a perennial theme in the US Army's rifle procurement process, especially when pressure arose during World Wars I and II to arm soldiers with automatic weapons.
17. For comments on the development and properties of smokeless gunpowder, see Smith, *Small Arms*, pp. 73-74. Changes in the projectile's aerodynamic shape were most noticeable in the .30'06 round, which was the first to use the so-called "spitzer" projectile. See Ormand M. Lissak, *Ordnance and Gunnery* (New York: John Wiley and Sons, 1915), p. 559.
18. Many critics attribute the Army's reluctance to adopt a magazine to the Ordnance Department's hidebound attachment to the Army's rifle tradition and its own Springfield breechloader. They fail to note the "user's" role in the process. Troops who line-tested various magazine guns in 1882 uniformly refected them in favor of their 1873 single

shot breechloaders. See Claude E. Fuller, *The Breech-Loader in the Service, 1818-1917* (New Milford: N. Flayderman and Company, 1965) p. 343. It is worth pointing out that much of the criticism directed at the Ordnance Department fails to take account of the Army user's own conservatism when it came to advances in small-arms technology. As this essay points out, the Ordnance Department's conservatism, which derived from logistics and financial concerns, was often matched by the Infantry's conservatism, a product of its attachment to the marksmanship tradition. Even as that tradition began to erode, enough infantrymen remained wedded to it to give the Ordnance Department allies elsewhere in the service.

19. For the board report urging the Krag's adoption and its use in this way, see James E. Hicks, *US Firearms, 1776-1956: Notes on US Ordnance*, Volume I (La Granada, CA: James E. Hicks and Son, 1957), p. 107.

20. For the '03 Springfield's history, see Cpt. Edward C. Crossman, *The Book of the Springfield* (Marines, NC: Small-Arms Technical Publishing Company, 1932). True to Army doctrine, the Ordnance Department modified the original Mauser action by adding a bolt-cutoff to allow for the Springfield's use as a single-shot piece. See Smith, *Small Arms*, p. 59.

21. There is no good published source on commonality as a goal of the US Army's small-arms development process, although many of the board reports of the late nineteenth century mention the need for using one round in as many weapons as possible. Indeed, even before machineguns came into use the Army sought to design its carbine and rifle around a single round in order to achieve the logistics advantages associated with producing and shipping only one cartridge. That commonality continued to influence the US Army's approach to small-arms development is noted in Dr. Frederick A. Cartens, *The M16 Rifle: A Case History* (unpublished, undated report written for the Blue Ribbon Defense Panel), p. 3.

22. Like the rifle, artillery had been in use for many years before technical improvements radically increased its combat effectiveness. Before glycerine recoil mechanisms were developed late in the nineteenth century, artillery pieces bounced backwards, and thus had to be repositioned and reaimed, each time they were fired. Recoil artillery was both more accurate and capable of more rapid fire than its predecessors. With its introduction the role artillery played in combat increased sizably. See Fuller, *Conduct of War*, pp. 135ff.

23. LtC. L. Van Loan Naisawald, "The High Cost of a Casualty," *Army*, September 9, 1968, pp. 61-63.

24. Julian S. Hatcher, *Hatcher's Notebook* (Harrisburg, PA: Military Services Publishing Company, 1948), p. 139.

25. Col. Frank D. Ely, "The Harnessed Power of the Trajectory," *Infantry Journal*, March 1918, p. 664.

26. Pershing stressed target practice at ranges up to 600 yards. See Russell F. Weigley, *History of the United States Army* (New York: MacMillan Company, 1967), pp. 380ff for a good account of Pershing's very traditional approach to tactics.
27. *Ibid.*, p. 390, and Col. R. Ernest Dupuy, *The Compact History of the United States Army* (New York: Hawthorn Books, Inc., 1961) p. 197.
28. See James E. Hicks, *What the Citizen Should Know About Our Arms and Weapons* (New York: W. W. Norton and Company, 1941), p. 91, and Daniel D. Musgrave and Thomas B. Nelson, *The World's Assault Rifles* (Washington, DC: The Goetz Company, 1967), p. 3.
29. Col. Aubrey Lippincott, "Firepower", *Cavalry Journal*, July 1928, p. 331.
30. Brigadier General H. S. Hawkins, "False Lessons in Combat Musketry Exercises", *Cavalry Journal*, March-April 1939, p. 154. See also Col. Altrichter, "Problems of Infantry Attack Tactics," *Infantry Journal*, May-June 1940, pp. 223-228.
31. U.S. War Department Document #1021, *Rifle Marksmanship* (Washington, DC: Government Printing Office, 1920), p. 40.
32. For developments in Europe, See Musgrave and Nelson, *Assault Rifles*, pp. 195, 213. For developments in the United States, see General Julian S. Hatcher's classic study, *The Book of the Garand* (Washington: Infantry Journal Press, 1948).
33. Hatcher, *Book of the Garand*, pp. 1, 56-59.
34. For a copy of MacArthur's directive, see *ibid.*, pp. 110-111.
35. *Ibid.*, p. 153.
36. Smith, *Small Arms*, p. 83.
37. Quoted in "The New Light Rifle," *Army Ordnance*, March-April, 1952, p. 750.
38. Van Loan Naisawald, "High Cost of a Casualty," p. 61.
39. See S. L. A. Marshall, "Return of the Infantry," *Infantry Journal*, July 1947, pp. 53-57. This is one of ten provocative articles Marshall published in successive issues of *Infantry Journal* between May 1947 and February 1948. The essays were collectively entitled "Battle Command in Future War."
40. See LtC. John E. Kelly's appropriately-titled article, "Shoot, Soldier, Shoot," *Infantry Journal*, January 1946, p. 47. See also LtC. Roy E. Moore, "Shoot, Soldier," *Infantry Journal*, April 1945, pp. 21-22, in which Moore states that "soldiers in Europe aren't shooting enough because they can't see anything."

41. U. S. Army, "The Infantry Conference: Report of Committee 'A' on Tactics and Technique," Fort Benning, Georgia, June 1946 (National Archives Record Group NNM, Box 130, Document #487), p. T-1/7. National Archives Record Group hereafter referred to as NARG.
42. *Ibid.*
43. *Ibid.*
44. U. S. War Department, War Department Equipment Board Report, 22 May 1946 (NARG #319, Box 334 "W"), p. 12. Headed by General Joseph Stilwell, this board has since been known as the Stilwell Board.
45. In fact, at the Infantry's request the Ordnance Department tried during the war to convert the M-1 to an automatic weapon. Although these converted M-1s weighed over 10 pounds, they suffered from heating and control problems. See Musgrave and Nelson, *Assault Rifles*, p. 373.
46. A concise history of the T-65 round was given to me during interviews with former Ordnance Department personnel. For a brief published account, see E. H. Harrison, "New Service Rifle," *American Rifleman*, June 1957, pp. 15-21.
47. See U. S. Army Ground Forces Board #3, "Report on Project #2184," (NARG #337, Box 51523, #2184), p. 3.
48. The best unclassified study of these events is Edward C. Ezell's "Cracks in the Post-war Anglo-American Alliance: The Great Rifle Controversy, 1947-1957", *Military Affairs*, December 1974, pp. 138-141.
49. For the Infantry Board's initial acceptance of the British round, see U. S. Army Field Forces, "Report of the Army Field Forces Board #3, Project #2231: Report of Joint Tests of United States and United Kingdom Light Weight Rifles and Ammunition Therefor," 27 October 1950 (NARG #337, Box 51524, #2231), pp. 78-79. For its revised position, see "Report of Army Field Forces Board #3, Project 2227A: Military Characteristics for a Light Weight Rifle," 14 December 1950 (NARG #337, Box 51524, #2227A), pp. 1-2 and Appendix 2.
50. Many critics of the M14 feel that although the rifle fired a bullet similar to the .30'06, it was less accurate than the M-1, largely because the Ordnance Department's attempts to make it lighter than the M-1 made it less stable. This does not invalidate the argument that it was a marksman's rifle, though it suggests that it was not a very good one!
51. Not all members of the Infantry Board were Army officers, since the Board also had a staff of more-or-less permanent civilians. Generally Army personnel rotated in and out of an assignment with the Board every three or four years, in accordance with standard rotation patterns for Army careers.

52. Among rifles tested by the Board during the first half of the decade were several M14 prototypes, a caliber .30 weapon named the T48 and manufactured by Fabrique Nationale, two experimental high velocity caliber .22 rifles, and the Armalite caliber .30 AR10.

53. Col. Henry Neilson deserves mention here. As head of the Board from 1956 to 1958 Neilson seems to have been instrumental in giving it forceful direction when it broke with the M14 development program in 1956-57. Neilson had at one time been a trained marksman of considerable skill, but had found his training singularly useless during combat in World War II. He thus favored the assault rifle concept out of personal experience, though he was also impressed by the work done by ORO and BRL.

54. For a useful history of the ORO and its work in Korea, see W. L. Whitson, "The Growth of the Operations Research Office in the United States Army," *Operations Research*, November-December 1960, pp. 809-824, and especially p. 812.

55. Norman Hitchman, *Operational Requirements for an Infantry Hand Weapon, ORO-T-160* (Chevy Chase, MD: Operations Research Office, Johns Hopkins University, 19 June 1952), p. 9. The basic ORO work on small-arms in Korea was S. L. A. Marshall's *Commentary on Infantry Operations and Weapons Usage in Korea, Winter of 1950-51* (Chevy Chase, MD: Operations Research Office, Johns Hopkins University, 27 October 1951), especially pp. 7-8.

56. Jacob A. Stockfish, "Field Experimentation and Small Arms Evaluation," *Military Review*, August 1969, p. 80n, where the author notes that "...large aiming errors on the part of soldiers rendered nugatory the worth of designing small-arms to achieve high accuracy."

57. See Hitchman, *Operational Requirements*, pp. 3-4. By 1955 ORO analysts had focused on two versions of the T65 (7.62 NATO) round, one firing two small projectiles, the other firing three. Later the ORO turned to flechettes, and in this sense their work directly influenced the concept for the Army's Special Purpose Individual Weapon, about which much will be said later in this essay. For a general look at the ORO's evolving attitude on this issue, see Leon Feldman and William C. Pettijohn, *Rifle Accuracies and Hit Probabilities in Combat, ORO-SP-158* (Chevy Chase, MD: Operations Research Office, Johns Hopkins University, November 1960).

58. The two caliber .22 cartridges listed here were the work of Mr. Gerald A. Gustafson of the Army's Development and Proof Services, an organization co-located with BRL at the Army's Aberdeen Proving Grounds. Although funded by the Ordnance Department as a very low-key, experimental effort, Gustafson's cartridges and the rifles that fired them were demonstrated before members of the Infantry Board in 1953. This demonstration and ORO's rifle tests of 1956 both spurred the Board's interest in small-caliber high velocity projectiles.

59. U. S. Army Development and Proof Services, "25th Report of Project TS1-2," 29 September 1953, Available through the BRL Technical Library, Aberdeen Proving Grounds, MD.

60. See especially Donald L. Hall, *An Effectiveness Study of the Infantry Rifle*, BRL Memorandum Report 593 (Aberdeen, MD: BRL Technical Library, March 1952), p. 11.

61. Called the SALVO tests, these were originally ORO's idea and were designed to test multiple projectiles against a combat-like target set. BRL later gained permission to have its own ideas tested as well. The importance of the SALVO tests should not be overlooked. Historically, the Army decided on the kind of rifle it wanted, then tested prototypes for their technical perfection. ORO worried not about the weapons so much as the target array; every effort was taken to insure that targets appeared and disappeared quickly, were obscured by brush, and so forth, just as they were in combat. ORO then tested a variety of conceptually *different* rifles against this target set to see which one performed most effectively. This was a very new and untraditional method, one the Army itself employed for the Small Arms Weapons System Study in 1966.

62. For this point the author draws on his own experience in the Army from 1968-1970. In one instance (1974) rifle instruction began with a short history of the M16 during which the instructor noted -- in all seriousness -- that the idea for the M16 came from Mattel Toy Co.

63. The Infantry Board had established 500 yards as the maximum effective range required of a rifle. Both the AR15 and M14 projectiles penetrated a helmet at that range.

64. U. S. Continental Army Command Board #3, "Report of Board #3, Subject: Evaluation of Small Caliber High Velocity Rifles -- Armalite AR15," September 1958 (copy provided by former Ordnance Department personnel). See also Musgrave and Nelson, *Assault Rifles*, pp. 440ff.

65. While ORO analysts were busy discovering that few soldiers aimed their shots or fired to the ranges normally associated with marksmanship training, officers in Korea were just as busy lauding the usefulness of marksmanship in combat and crying for better marksmanship training. For examples of this trend, see Lt. Arthur R. Underwood, Jr. "Command the Trigger," *Infantry school Quarterly*, April 1954, p. 11, and Col. John T. Corley, "New Courses for Old Traditions," *Combat Forces Journal*, June 1953, p. 14. See also the editorial comments in *Army Ordnance*, March-April 1955, p. 743, a stirring appeal for the revival of marksmanship training. These articles had more effect on service thinking -- at least in the short run -- than ORO's carefully documented but closely held work; after 1951 marksmanship training and the National Rifle Matches enjoyed resurgent popularity.

66. Including the Chief of Staff, General Maxwell Taylor, Interview with General Taylor, USA (Ret.), September 20, 1976 in Washington, DC.

67. During this first controversy the Ordnance Department vented its hostility to the new weapon during technical tests of the piece conducted just after the Infantry Board favorably tested it at Fort Benning. In these it was discovered that, because its bore was narrower than the M14's, the AR15's barrel tended to retain water via capillary action after immersion during the standard water tests. An AR15 fired with water in its bore generally suffered a ruptured barrel, and Ordnance Department officers duly paraded an AR15 in this condition through the halls of the Defense Department. They neglected to mention that the M14 suffered much the same problem under the right conditions, that simply tilting the rifle's muzzle downwards and pulling the bolt back slightly let the water spill out, and that, because of its smaller bore, the AR15 was less likely to become filled with water in the first place. Incidents like this tended to create deep-seated animosity between members of the Infantry Board and the Ordnance Department.

68. Carten, "Case History," p. 12.

69. *Ibid.*

70. Taylor interview. Remembering the M-1's popularity and usefulness during the Second World War, Taylor concluded that even though the M14 represented nothing more than a product improvement over the M-1, it must still be a fine weapon.

71. Although part of the reason for the relatively rapid dissipation of the first rifle controversy owed to the tendency of military men to accept their commander's decision as final, another factor might have been the retirement in 1958 of Colonel Henry Neilson, the head of the Infantry Board, as well as General Willard G. Wyman, commanding general of the Continental Army Command, who was also enthusiastic about the AR15 and had in fact funded its development.

72. See House Committee on Armed Services, Special Subcommittee on the M-16 Rifle Program, *Hearings*, 90th Cong., 1st Sess., pp. 4741, 4780. Referred to hereafter as *Hearings, M16 Rifle Program*.

73. *Ibid.*, pp. 4795-4796.

74. Armalite's president, Mr. Richard Boutelle, met General LeMay when both were in the Air Force. For details of how the two came together with the AR15, see *ibid.*, p. 4800. For the U.S. Air Force's rifle problems, see *ibid.*, p. 4863.

75. Memorandum, Office of the Chief of Ordnance, Subject: Replacement of .30 caliber Carbine for USAF, 17 April 1961 (found in Washington National Records Center, Suitland, MD, Accession #64A2273, Box 31, "Rifles". Referred to hereafter as WNRC, Acc#, etc. My thanks to Mr. Taborn of the Army Adjutant General's Office, Washington, DC, for helping me gain access to these files.)

76. Memorandum for the President, Subject: Armalite (AR-15) Rifle, 28 December 1961, From Chairman of the Joint Chiefs of Staff Lyman Lemnitzer (WNRC, Acc #64A2164, Box 20, CS474, file 61).

77. Certain of ARPA's members had begun to question the nation's ability to support its allies in limited war situations even before Kennedy took office, but received little encouragement from the Eisenhower administration. In spring of 1961 ARPA finally received permission to begin project AGILE, the object of which was "research and engineering support for the military and paramilitary forces engaged in or threatened by conflict in remote areas of the world." The AR-15 tests were part of this project. See ARPA's director's comments on this project in House Committee on Appropriations, Subcommittee on Department of Defense, *DOD Appropriations for FY1963, Hearings*, 88th Cong., 1st Sess., Part 6, pp. 221-223.
78. The photographs that accompanied the ARPA test report were and remain classified, although their reputation was widespread. The test itself, US Department of Defense, Advanced Research Projects Agency, *Report of Task 134, Test of Armalite Rifle, AR-15, 31 July 1962*, may be found in WNRC, Acc# 65A3246, Box 29/49, CS474, 1962.
79. US Army Materiel Command, "A Concise History of the M16 Weapon System," (undated, unpublished manuscript), p. 4. Referred to hereafter as "Concise History".
80. *Ibid.*
81. House Committee on Appropriations, Subcommittee on DOD, *DOD Appropriations for FY1963, Hearings*, 88th Cong., 1st Sess., Part 6, p. 224.
82. US Department of Defense, Office of the Assistant Secretary of Defense, Comptroller, "A Comparison of AR-15 and M-14 Rifles," 27 September 1962, p. i. (Personal copy supplied by the Office of the Assistant Secretary of Defense for Public Affairs).
83. Interview with Dr. Alain C. Enthoven, in Atherton, CA on July 11, 1976.
84. Office of the Chief of Staff, US Army, Memorandum for the Secretary of the Army, Subject: Rifle Procurement Program, 29 September 1962 (WNRC, Acc# 65A3246, Box 29/49, CS474, 1962), p. 1.
85. *Ibid.*, p. 2.
86. Office of the Secretary of Defense, Memorandum for the Secretary of the Army, 12 October 1962.
87. Science advisor Jerome Weisner presented Kennedy with a 9 page summary of the Hitch Report on 31 October 1962. This document and a note concerning Kennedy's reaction to it may be found in WNRC, Acc#65A3246, Box 29/49, CS474, 1962).
88. This conclusion comes from a variety of officers and civilians working with Wheeler at the time. There exists as well a memorandum for record written by the Army's Deputy Chief of Staff for Research and



Development, Subject: Rifles, dated 5 March 1963, which records a conversation with the Chief of Staff in which Wheeler reportedly expressed his skepticism about the SPIW and voiced the idea that "perhaps the AR-15 would be the Infantry weapon of the future," (WNRC, Acc# 65A3246, Box 29/49, CS474, 1962).

89. This investigation produced four huge volumes of testimony, but only one official reprimand -- to an infantry captain on the Infantry Board whose enthusiasm for marksmanship led him to test the AR15 to ranges of 800 yards, well beyond those called for in his instructions.

90. See "Defense Highlights: Big Job for Small Rifle", and "New Developments: New Infantry Weapon," *Ordnance*, May-June 1963, pp. 642 and 714, respectively.

91. Headed by U.S. Army Colonel Harold W. Yount, the TCC was comprised of members from each service with an interest in buying the AR-15. Its instructions were to develop one version of the weapon for all buying services in the shortest possible time. For Yount's description of the TCC, see *Hearings, M16 Rifle Program*, pp. 4656-4658.

92. Letter from Col. Yount to the Army's Deputy Chief of Staff for Logistics, Subject: Progress Report RCS DD-SD(M) 554, AR15 Rifle, 30 September 1963, p. 5. (Author's personal copy provided by members of the Ordnance Department -- most of Col. Yount's correspondence is unavailable.)

93. Carten, "Concise History," pp. 19-20.

94. Office of the Assistant Chief of Staff for Force Development, "Discussion of Alternatives Open to the Army in Regard to the AR-15 Rifle," Inclosure 5, 24 September 1963 (WNRC, Acc# 67A4910, Box 50, CS474). What gave the Army's suggestion special significance was the fact that Colt's was about to finish producing the AR15s General LeMay had ordered in 1962, and without the Army's new order the production line there would go "cold", thereby compounding McNamara's problems.

95. McNamara publically announced termination of M14 production in January 1964, though he informed the Army Chief of Staff of the decision in December 1963. See Memorandum, Subject: M14 Rifle, 4 December 1963 (WNRC, Acc# 68A3306, Box 57, CS474, Case 4-8).

96. *Hearings, M16 Rifle Program*, pp. 5004ff. It is worth noting that in order to get the rifle into production, OSD finally accepted the Army's major suggestions for the weapons development. Such was the limited power of OSD to push the service into action in the technical area.

97. There is evidence that McNamara himself was entranced with the SPIW. On a visit to Fort Benning in July 1963 the Defense Secretary saw SPIW prototypes demonstrated, and expressed the hope that 1000 copies of the weapon could be sent to the Republic of Vietnam for testing.

His Army escorts soon talked him out of the idea on grounds that to purchase 1000 copies of any single prototype would amount to prejudging the SPIW's competitive development. Nonetheless, McNamara's comment suggests a genuine interest in the SPIW -- and a desire to see it tested in the field just as ARPA had tested the AR15. See US Army Infantry Board, "Notes From Visit of Secretary of Defense McNamara and Secretary of the Army Vance on 25 July 1963," (WNRC, Acc#67A4857, Box 41, CS474, Case 1-4), Inc. 1, p. 1.

98. Letter, 6 August 1964, quoted in Office, Secretary of the Army, *Report of the M16 Rifle Review Panel*, Appendix 5, 1 June 1968 (WNRC, Acc# 71A3072, Box 21/62), p. 5-24. Emphasis added.

99. Most of these problems stemmed from the need to push the weapon's tiny flechette projectiles to extremely high velocities (over 4000 fps) to achieve sufficient lethality. Doing so took so much powder that the SPIW prototypes suffered from severe heating problems at one end of the barrel, excessive muzzle flash at the other. See Edward C. Ezell, "SPIW: Origin and Development of the Army's Undelivered Super Rifle," *The Rifle Magazine*, March-April 1969, pp. 12ff.

100. *Ibid.* This point was also made in interviews with former Ordnance Department personnel.

101. Jacob Stockfish puts this view most succinctly in his *Plowshares Into Swords* (New York: Mason and Lipscomb, 1973), p. 173:

The SPIW program, unfortunately, was not a weapon; it was a political tactic...[i]n the sense that Army thinkers quickly conceived the program as a way of heading off a possible major purchase of M16s.

It should be noted that Stockfish was the civilian director of the Force Planning and Analysis Office, and in this capacity had some influence over the Chief of Staff's decision in 1966 to place the weapon in a long term, low-key research program. Work on the SPIW was finally cancelled in 1974.

102. Interview with Mr. Eugene M. Stoneron January 7, 1977 in Port Clinton, Ohio. In 1960 the AR15 had no major buyers, and ArmaLite itself was doing badly financially. Thus Stoner went to work for Cadillac-Gage, where he designed the Stoner-63.

103. Department of the Army, Memorandum for the Secretary of the Army, Subject: Army Small Arms Weapons program, 11 November 1964 (WNRC, Acc# 67A4857, Box 41, CS474, #2), p. 1.

104. *Ibid.*

105. The SAWS Study ran to over 30 volumes of material, many of which can be obtained through the Defense Documentation Center, Cameron Station,

Alexandria, VA. For a good published account of the most important of the study's findings, see Jacob A. Stockfish, *Models, Data and War: A Critique of the Study of Conventional Forces, R-1526-PH* (The Rand Corporation, March 1975), pp. 95-104.

106. Given that funding for the SPIW's development was reduced after 1967, some of the weapon's advocates still feel that continued attention to the weapon's development would have produced a fine infantry weapon. See for example Irwin R. Barr's "SPIW: A New Look", *The Rifle Magazine*, July-August 1969, pp. 30ff.

107. "Army Staff Discussion, Conclusions, and Recommendations, Small Arms Weapons Systems (SAWS) Study", (document found in WNRC, Acc#69A2595, Box 64/89, CS474), p. 2.

108. *Ibid.*

109. Jacob Stockfish, the Force Planning and Analysis Office's first civilian director, and Stanley Resor, the Secretary of the Army who helped create the agency, disagree on its origins. Stockfish maintains that the agency represented Resor's and Chief of Staff Harold Johnson's effort to keep OSD out of the service's affairs by confronting it with systems analysis conducted by the Army itself. Resor, on the other hand, contends that the idea for the agency was given to him by McNamara's chief systems analyst, Dr. Alain C. Enthoven, over lunch soon after Resor had become Secretary of the Army. Enthoven genuinely wanted to see the service develop its own systems analysis capability. The two views are not mutually exclusive; the organization may have been created with both purposes in mind, or its function may have changed over time. Interviews with Dr. Jacob A. Stockfish on October 12, 1976 and Mr. Stanley R. Resor on May 2, 1977, both in Washington, DC.

110. Office Memorandum, Office of the Chief of Staff, Subject: Small Arms Weapons Systems (SAWS) Study, undated, from Dr. Stockfish. (WNRC, Acc# 69A2595, Box 64/89, CS474), p. 4.

111. Telephone interview with General William C. Westmoreland, US Army (Ret.), on March 22, 1977. See also General Westmoreland's book, *A Soldier Reports* (Garden City, New York: Doubleday and Company, Inc., 1976), p. 158.

112. This was the Army's own claim concerning the cause of the problem, and some in the service asserted that Colt's Firearms distributed in Vietnam promotional literature claiming that the rifle simply could not jam under any conditions. Colt's officials denied these accusations, and in fact this author could find no evidence of promotional literature. Interviews with Army officers whose units received M16s in Vietnam in 1966 suggested, however, that the rifle indeed had the reputation of "miracle weapon."

113. Westmoreland actually ordered a total of about 300,000 rifles for all allied forces in Vietnam. There was some resistance within the

Defense Department to rushing ahead in this fashion, however, and after a brief period of negotiation Westmoreland settled for an initial order of 179,000 copies of the rifle. See US Army Materiel Command, "Concise History", p. 12.

114. *Ibid.*

115. Office of the Assistant Chief of Staff for Force Development, Subject: Army Requirements for the M16 Rifle, 21 April 1965 (WNRC, Acc# 68A3306, Box 57, CS474, Case 9), p. 1.

116. Interviews with members of OSD suggest that McNamara's reluctance may have stemmed from his belief, apparently held through 1966, that the nation's commitment to the war effort remained reversible, that in fact the U. S. might soon begin decreasing its force levels in Vietnam. He thus saw no sense in initiating a major increase in the weapon's production.

117. In fact, Colt's felt able to fill an order given it in the summer of 1966 by Singapore for 20,000 M16s. Colt's requested and was granted an export license for the sale by the Department of State. News of the sale produced no small furor in Korea, where it was felt that Korean soldiers fighting in Vietnam should have received any excess Colt's was capable of producing. See "US Okays Purchase of 23,000 New-Type Rifles to Singapore," *The Korean Herald*, Seoul, March 8, 1967, p. 1.

118. Resor interview.

119. Interview with General Harold K. Johnson on April 12, 1977 in Washington, DC.

120. *Ibid.*

121. Quoted in Carten, "Case History," p. 23.

122. Also called the "Ichord Hearings" after Congressman Richard H. Ichord, chairman of the Special Subcommittee on the M16 Rifle Program. These hearings comprise the *Hearings, M16 Rifle Program*. See also House Committee on Armed Services, *Report by the Special Subcommittee on the M-16 Rifle Program*, 90th Cong., 2d Sess., September 26, 1968.

123. It would be impossible to deal with the jamming controversy in any detail in this essay, nor would doing so contribute to the essay's central theme. Unfortunately, there is no published account of the controversy. I treat this in depth in my dissertation, chapter V, and it is dealt with at length if disjointedly in the *Hearings, M16 Rifle Program*, *supra*.

124. Westmoreland interview.

125. Cyert and March focus on the key internal variable discussed here when they argue that "except at the level of non-operational objectives,

there is no internal [organizational] consensus." See Richard M. Cyert and James G. March, *A Behavioral Theory of the Firm* (Englewood Cliffs, NJ: Prentice-Hall, Inc., 1963), p. 117.



RAND/P-6306

MARKSMANSHIP, MCNAMARA, AND THE M16 RIFLE:  
ORGANIZATIONS, ANALYSIS, AND WEAPONS ACQUISITION

McNaughter

# **EXHIBIT 2**



**5.56mm AMMUNITION COMPARISON  
TEST REPORT  
Phase I**



*DRAFT*

*January 2004*

**Marine Corps Systems Command  
Program Manager For Ammunition  
(MARCORSYSCOM(AM))  
QUANTICO, VA**

**5.56mm AMMUNITION COMPARISON  
TEST REPORT  
Phase I**

**CONCURRENCE:**

---

Mr. Scott Allred (Signature) (Date)  
Staff Engineer  
MARCORSYSCOM(AM)

---

Capt. Jeffrey Young (Signature) (Date)  
HD IWAT  
MARCORSYSCOM (AM)

**APPROVAL:**

---

Col Michael Brogan (Signature) (Date)  
Program Director, Infantry Weapons Systems  
MARCORSYSCOM(IWS)

---

Mr. Jerry Mazza (Signature) (Date)  
Program Manager for Ammunition  
MARCORSYSCOM(AM)

## **EXECUTIVE SUMMARY**

### **I. PURPOSE STATEMENT**

This test report compares and evaluates three types of 5.56mm cartridges the Marine Corps will use with the M16/M4 series of combat rifles. A great deal of anecdotal evidence has been generated discussing the various shortcomings of the A053 (M855) 5.56 mm cartridge. This discussion has been in regards to both the accuracy and the terminal effects of the ammunition. Both the Army and Navy, documenting the results of testing that were performed to verify, or refute, the claims regarding the terminal effects, have published reports. In both instances, while demonstrating that the claims might be true, a realistic evaluation could not be made because of shortcomings in the testing or reporting of the information. The test performed by the Naval Surface Warfare Center, Crane, Indiana was limited in the number of rounds of ammunition tested, only one round of each type and the Army report did not document any of the procedures used to generate the data.

### **II. RESULTS**

The 77-grain Black Hills Nosler w/cannelure (BLH2) demonstrated superior overall performance with respect to both accuracy and terminal effects. The increased performance was observed in both the M4A1 and the M16A2 throughout all scenarios of engagement range and temperature extremes.

### **III. RECOMENDATION**

Recommend that an assessment to determine what level, if any, the BLH2 cartridge should be integrated into the Marine Corps small arms inventory. This assessment should include cost differential between each cartridge compared to the increase in cartridge performance.

# 5.56mm AMMUNITION COMPARISON TEST REPORT Phase I

## TABLE OF CONTENTS

<b>1.0 INTRODUCTION</b> .....	6
1.1 SCOPE .....	6
1.2 PURPOSE .....	6
1.3 TEST OBJECTIVES.....	7
<b>2.0 DESCRIPTION OF TEST ASSESTS</b> .....	7
2.1 TEST WEAPONS .....	7
2.1.1 Test Barrel 20.0” .....	7
2.1.2 Test Barrel 14.5” .....	7
2.1.3 M4A1 .....	7
2.1.4 M16A2 .....	7
2.2 AMMUNITION VARIANTS TESTED .....	7
2.2.1 M855, A059 .....	7
2.2.2 M855, AA48.....	7
2.2.3 Sierra Match King, AA53 .....	7
2.2.4 Nosler (Black Hills) .....	7
2.2.5 Nosler (Black Hills) .....	7
<b>3.0 TEST PROCEDURES</b> .....	7
3.1 ACCURACY TEST PROCEDURE .....	7
3.2 TERMINAL BALLISTICS TEST PROCEDURE (GENERAL).....	8
<b>4.0 DATA ANALYSIS</b> .....	10
4.1 ACCURACY TESTS .....	10
4.2 TERMINAL EFFECTS TEST .....	11
<b>5.0 TEST RESULTS</b> .....	12
5.1 ACCURACY TEST RESULTS.....	12
5.2 TERMINAL EFECTS TEST RESULTS.....	13
5.2.1 RELATIVE TEMPORARY CAVITY VOLUME .....	13
5.2.2 DEPTH TO FIRST YAW .....	15
<b>6.0 CONCLUSIONS &amp; RECOMMENDATIONS</b> .....	15
<b>7.0 FIGURES</b>	
1. Gelatin Block Calculation Guide .....	11
2. Ballistic Comparison Relative Cavity .....	13
3. Ballistic Comparison Total Score .....	14
4. Ballistic Comparison Relative Volume.....	14
5. Depth to Initial Yaw .....	15
6. Complied Results .....	15

## APPENDIX

### TABLES

I.	Accuracy Comparison	
	a. M4A1: A059, AA48, BLH2.....	16
	b. M16A2: A059, AA48, BLH2.....	17
II.	Accuracy Summary Test .....	18
III.	Wound Cavity Data.....	19
IV.	Terminal Effects.....	20

### SELECTED BALLISTIC PHOTOGRAPHS

1. M4A1 (14.5” barrel; 1:7 twist)
  - a. Cartridge (A059), Range (10m)
  - b. Cartridge (AA48), Range (10m)
  - c. Cartridge (BLH2), Range (10m)
  - d. Cartridge (A059), Range (50m)
  - e. Cartridge (AA48), Range (50m)
  - f. Cartridge (BLH2), Range (50m)
  - g. Cartridge (A059), Range (100m)
  - h. Cartridge (AA48), Range (100m)
  - i. Cartridge (BLH2), Range (100m)
  - j. Cartridge (A059), Range (300m)
  - k. Cartridge (AA48), Range (300m)
  - l. Cartridge (BLH2), Range (300m)
2. M16A2 (20.0” barrel; 1:7 twist)
  - a. Cartridge (A059), Range (10m)
  - b. Cartridge (AA48), Range (10m)
  - c. Cartridge (BLH2), Range (10m)
  - d. Cartridge (A059), Range (50m)
  - e. Cartridge (AA48), Range (50m)
  - f. Cartridge (BLH2), Range (50m)
  - g. Cartridge (A059), Range (100m)
  - h. Cartridge (AA48), Range (100m)
  - i. Cartridge (BLH2), Range (100m)
  - j. Cartridge (A059), Range (300m)
  - k. Cartridge (AA48), Range (300m)
  - l. Cartridge (BLH2), Range (300m)

NOTE: Photos selected represent similar visual characteristics of each shot group.

## 1.0 INTRODUCTION

### 1.1 SCOPE

The Marine Corps Systems Command initiated the terminal ballistic assessment to address highlighted concerns from deployed units, support previous 5.56mm evaluations, and determine if a more terminally effective 5.56mm cartridge is currently available. Recent combat operations highlighted terminal performance problems. These problems were generally perceived as failures to: 1) Rapidly incapacitate opponents at ranges beyond 150-200 meters, as well as close ranges up to 50 meters, and 2) occurring when Standard M855 Ball and M855 62gr “Green Tip” Full Metal Jacket (FMJ) cartridges are fired from 5.56mm rifles and carbines.

Both the Navy (Naval Surface Warfare Center (NSWC) – Crane Division) and the Army (U.S. Army Armament Research, Development, and Engineering Center (ARDEC)) published reports documenting 5.56mm cartridge test results to verify or refute the claims regarding the terminal effectiveness on several types of 5.56mm cartridges. Both test results validated the claims but a realistic evaluation could not be made due to variations in test methods, statistical sample firings, target composition, data produced, and test conclusions. The tests performed by NSWC, Crane were limited to testing only one round of each type. The ARDEC report did not document any of the procedures used to generate the data. Due to these discrepancies, the Program Managers for both Ammunition and Infantry Weapons Systems performed, managed, and tested the 5.56mm cartridges. This additional independent evaluation is critical to supporting future Marine Corps 5.56mm acquisition strategy.

### 1.2 PURPOSE

The purpose of this evaluation is assess selected and available 5.56mm cartridges. This will determine which four 5.56mm rounds of ammunition is optimal for use by the Marine Corps in the M16/M4 families of combat rifles. This evaluation will yield the optimum combinations of ammunition type and combat rifle at specific engagement ranges. The engagement ranges were selected to evaluate the tactical scenarios of Close Quarters Battle (CQB), Military Operations in Urban Terrain (MOUT), Closed Terrain, and Open Terrain. In addition, if possible, it will provide the single best normalized combinations of ammunition and combat rifle.

Each cartridge was evaluated to document performance, accuracy and terminal effectiveness. However, of the five cartridges evaluated, only the results from the A059, AA48 and BLH2 are presented in this report. The results of the remaining two cartridges, AA53 and BLH1, were only evaluated for informational purposes. It was determined that these cartridges are unsuitable for general combat use due to lack of cannelure and moly coating, respectively. A description of each type of cartridge evaluated is provided in section 2.2.

### 1.3 TEST OBJECTIVES

The objective of this test is to validate and compare the inherent accuracy of the subject ammunition when fired from the M4A1 carbine and M16A2 rifle. In addition, the test will evaluate & compare the terminal effects of the ammunition fired from both weapons when fired into 10% ballistic gelatin blocks. The blocks are composed of 250A ballistic gelatin, mixed with approximately 10% water. In addition, the weight of the blocks are approximately 40lbs. with dimensions of 18”(length), 9”(width), and 8”(height).

## 2.0 DESCRIPTION OF TEST ASSETS

### 2.1 TEST WEAPONS

- 2.1.1 Test barrel (20.0” barrel; 1:7 twist); 1 each– Mounted on FBI Model 700 Receiver
- 2.1.2 Test barrel (14.5” barrel; 1:7 twist); 1 each– Mounted on FBI Model 700 Receiver
- 2.1.3 M4A1 (14.5” barrel; 1:7 twist); 3 each (new weapons)
- 2.1.4 M16A2 (20.0” barrel; 1:7 twist); 3 each (new weapons)

### 2.2 AMMUNITION VARIANTS TESTED

- 2.2.1 M855, A059: 62gr Ball (Baseline)
- 2.2.2 M855, AA48: 62gr Ball Environmentally Safe
- 2.2.3 Sierra Match King, AA53: 77gr. (Black Hills, SOPMOD SPR) –Pending Type Classification (non-Cannelure)
- 2.2.4 Nosler (Black Hills) 77gr w/Cannelure; Non-Moly Coated
- 2.2.5 Nosler (Black Hills) 77gr w/Cannelure; Moly Coated

## 3.0 TEST PROCEDURES

### 3.1 Accuracy Test Procedure

Accuracy tests were performed by the Weapons Training Battalion, The Basic School (TBS), Marine Corps Base, Quantico, VA using the following procedure:

*NOTES: 1. No testing was performed in head winds exceeding 10 mph or crosswinds in excess of 5 mph  
2. Test Weapons: 3 each (new) M4A1 and M16A2.  
3. To avoid barrel creep due to the change in temperature of the barrel, the test weapon is fired to raise the barrel temperature.*

1. Secure test weapon in a suitable firing fixture. Record, if available, weapon type, serial number and rounds count.
2. Measure and record muzzle velocity using velocity screens.

3. Place and secure accuracy target at 300m. Mark target with weapon type, ammunition type, date and time.
4. Sight weapon on target so that a center mass impact shall occur. Use an optical (scope) or laser sighting device to ensure accuracy and repeatability of aim point.
5. Load specified ammunition into weapon. (Temperature of ammunition shall be at Range Ambient. Record temperature.)
6. Fire ten (10) single shots into the accuracy target without disturbing the lay of the weapon. Verify aim point between each shot to assure that lay of the weapon has not changed. In the event the aim point has shifted, test shall be scored as a “No-Test” and repeated. At the end of the ten shot-firing group, projectile impacts shall be marked to identify group and target shall be replaced.
7. Repeat above process until three (3) 10 round shot groups have been obtained.
8. Repeat process for each type of ammunition.
9. Repeat process for each weapon type.
10. Repeat process with ammunition temperature condition at -25°F.
11. Repeat process with ammunition temperature condition at 120°F.
12. Required Data:
  - a. Weapon type/serial number
  - b. Cartridge type
  - c. Average muzzle velocity of 10 shot group
  - d. Accuracy information:
    - ii. Each 10 round target: X, Y, X-Average, Y-Average, X Standard Deviation (SD), Y SD, X-Y range
    - iii. Three: 10 Round Target Pooled Data: Average X SD, Average Y SD
  - e. Noted malfunctions, anomalies and/or remarks
  - f. Range Ambient Temperature of each shot

### 3.2 Terminal Ballistics Test Procedure (General)

Terminal ballistics testing was performed by the FBI Academy. Testing was performed according to the following procedure:

- NOTE:*
1. All Tests Performed at Range Ambient Temperature.
  2. Nosler 77gr w/Cannelure BLH1; Moly Coated shall not be fired for terminal ballistic evaluation.
  3. Test Weapons; M4A1 (14.5” barrel; 1:7 twist), M16A2 (20.0” barrel; 1:7 twist)

1. Secure test weapon in a suitable firing fixture. Record, if available, weapon serial number and rounds count.



2. Measure and record muzzle velocity using velocity screens.
3. Set up the Paper/Cardboard target at the specified range (as required). Erect velocity screens to obtain impact velocity data.
4. Sight weapon on a paper/cardboard target (as required).
5. Fire weapon on the paper/cardboard target until a three-round shot group lies within the useable area of the target (as required).
6. Remove the paper/cardboard target and replace with the 10% ballistic gelatin target once the weapon is sighted and impact velocity instrumentation operational. Range personnel shall ensure that the gelatin target is properly aligned with the previously established impact point.
7. Verify prior to firing the ballistic gelatin block calibrations.
8. Clear range to fire one round into the ballistic target.
9. Ballistic Gelatin Recalibration: If the FBI Ballistic Research Facility participants question the state of the ballistic gelatin, the calibration shot will be repeated after shot impact.
10. If shot is scored as a valid impact the following ballistic target data will be evaluated:
  - a. Depth to the initial indication of projectile yaw
  - b. Volumetric evaluation of temporary cavity (height, width, depth)
    - i. Multiple measurements shall be made to adequately characterize produced cavity.
  - c. Photographs of ballistic gelatin block
    - i. Gelatin block shall be rotated and photographed from an angle that best depicts both the permanent and temporary cavities generated (multiple photographs). Each photograph shall contain a ruler placed on the gelatin block for scale.
11. If the shot is scored as an invalid impact, evaluate the ballistic target for useful information. If no useable information can be gained, no further evaluation shall take place. An invalid impact shot will be scored as a “No-Test” and the target shall be discarded. Any data recorded shall be for informational purposes only and not used in the final evaluation. Additional cartridges shall be fired until a valid impact is obtained. A “No-Test” is defined as a target that offers no measurable value (for example, inaccurate round placement on target).
12. Repeat test series until five valid test shots are obtained for each test cartridge.

13. Repeat test iteration for each cartridge type at each range in each type of test weapon.

14. Data Collected:

- a. Test weapon type and serial number
- b. Cartridge type
- c. Muzzle velocity
- d. Impact velocity
- e. Initial projectile yaw depth
- f. Gelatin cavity measurements (height, width, and depth (viscosity of gelatin)); multiple measurements
- g. Photographs as noted in test procedure. Photographs shall be marked with test weapon type, ammunition type, date, and time
- h. Pre and post firing ballistic gelatin block calibration verification (as required)
- i. Noted malfunctions, anomalies, and remarks

## 4.0 DATA ANALYSIS

### 4.1 Accuracy Tests

Three M4A1 carbines and three M16A2 rifles were used. For each individual weapon, three ten-shot groups of each type of ammunition were fired at three different temperatures (3 groups x 10 rounds x 3 temperatures), providing 90 data points, per individual weapon, per ammunition type. Although five different rounds were fired during the accuracy portion of this test, only three were analyzed. Two of the cartridges were determined to be ineffective for field use. Therefore, analyses of AA53 and BLH1 cartridges are not included in this report.

For each of the targets (see Figure 1):

- a) A reference grid was drawn and the position of each hit point measured (to within +/- 0.05 inch).
- b) The ten hit points for each group were averaged to find the mean hit point.
- c) Distance from each hit point to the mean, and the associated standard deviation, were calculated.

Once this was completed for all of the targets, the data was tabulated. The resulting data points were compared by superimposing the targets and using the mean hit point as a reference. The data for each weapon & type of ammunition was then compiled and analyzed according to:

- a) The individual group (1 target).
- b) All groups at a common temperature (3 targets).
- c) All groups from the individual weapon (9 targets).
- d) All groups at the same temperature, from the same weapon type (9 targets).
- e) All groups from the same weapon type (27 targets).

Accuracy data is provided in Appendix (Ia, Ib and II).

#### 4.2 Terminal Effects Test

Terminal effectiveness data was collected by firing five shots each, of the three different ammunition types, from both weapons fixed a stationary platform, at ranges of 10, 50, 100, and 300 meters. All rounds were fired into gelatin blocks, per the Test Plan. Although the effects of a given bullet on the gelatin block cannot be directly compared to that of human tissue, due to the many variations found in the body (bones, cartilage, etc), the gelatin approximates the density of soft human tissue and provides a homogeneous medium for comparison. Measurement taken by the test personnel included:

- a) Muzzle velocity
- b) Impact velocity
- c) Depth to first yaw
- d) Length of temporary cavity
- e) Maximum temporary cavity height
- f) Maximum temporary cavity width
- g) Depth to maximum temporary cavity dimension (see e and f, above)

The temporary cavity is defined as the portion of the gelatin block having visual damage caused by the bullet and the associated pressure/shock wave. Depth to first yaw is defined as the point where the temporary cavity begins. A target block is shown in Figure 1.

#### Gelatin Block Calculation Guide

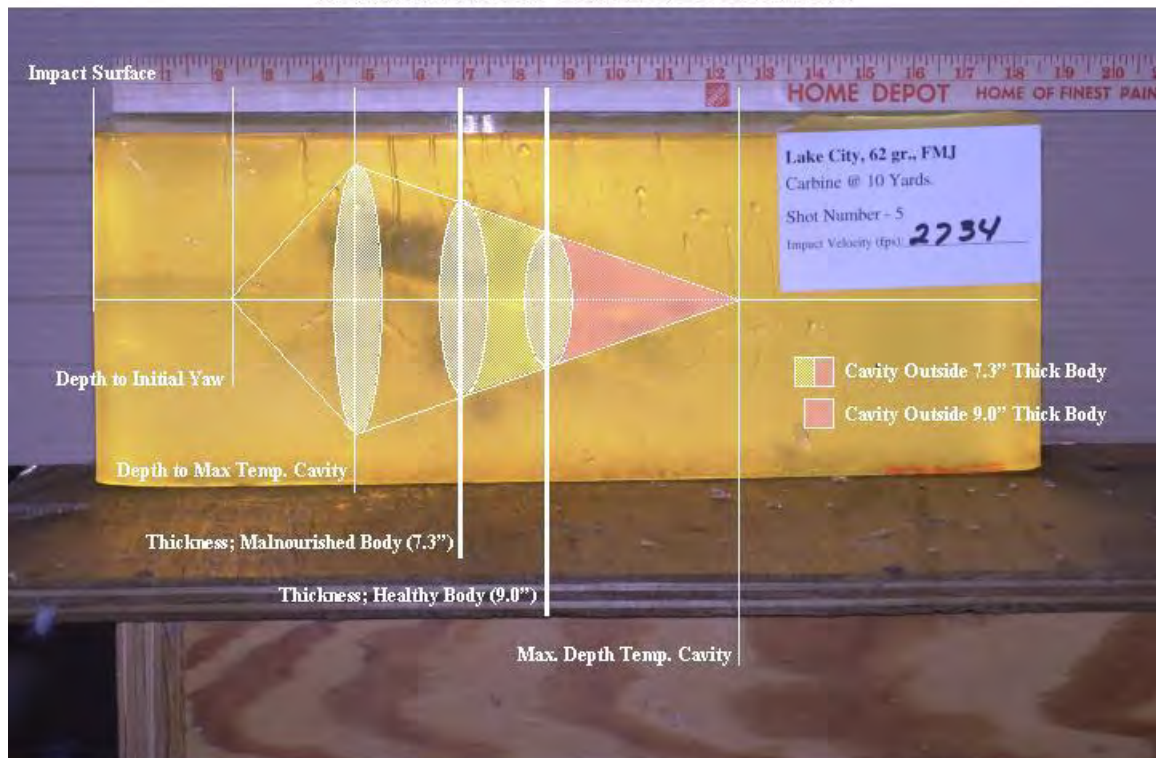

Figure 1

The most important two factors in determining terminal effects are depth to first yaw and volume of the temporary cavity. The total temporary cavity volume is an indicator of the effect the bullet would have on human tissue. A given projectile might consistently leave a very large temporary cavity, but if it occurs deep in the block, corresponding to a large depth to first yaw, most of the volume could have occurred after the bullet had exited out the back of a target. The amount of the temporary cavity that would occur inside an individual target is referred to as the relative cavity. Therefore, in order to compare temporary cavities, the depth of the target must be defined. For this test, two depths of the target were defined: 7.3 inches to correspond to a malnourished individual, and 9.0 inches to correspond to the healthy individual. This corresponds to the evaluated body thicknesses specified in the U.S. Army (ARDEC) evaluation. Wound cavity data is shown in Appendix III.

Determining the exact cavity volume would have required slicing the block and recording multiple measurements. This was determined to be outside the scope of this test. Based upon a review of several gel block targets, it was determined the volume can be approximated by back-to-back elliptical cones (see Figure 1).

When evaluated, the point of maximum height and width are elliptical, in most cases, and the general shape of the temporary cavity, from that point to either end, approximates a cone.

To determine the approximate effect on each of the two potential targets, for each temporary cavity that was calculated, the portion of the cavity volume that occurred past the depth of the defined targets was subtracted from the total volume. This was done for both target depths. The calculations used to determine the volume of the relative cavity are shown in section 5.2.1.

## 5.0 TEST RESULTS

### 5.1 Accuracy Test Results

Data was compiled to provide the 3-sigma ( $\sigma$ , SD) radius for each cartridge, fired from each weapon, for the three temperatures. Data indicator:

- a) Mean radius summed with three standard deviations ( $MR + 3\sigma$ ) for the following:
  - i) Each individual weapon and cartridge for each temperature
  - ii) Each individual weapon and cartridge for all temperatures
  - iii) Each weapon type and cartridge for each temperature
  - iv) Each weapon type and cartridge for all temperatures
- b) Average maximum range for situation iv, above  
(Defined as the distance between the two most distant hits on each target)
- c) Greatest maximum range for situation iv, above
- d) Smallest maximum range for situation iv, above

5.2 Terminal Effects Test Result

Data was compiled to demonstrate the depth to first yaw for each weapon firing each type of ammunition. Rankings were tabulated in two ways: the first based upon the size of the relative temporary cavity, and the second based upon depth to first yaw. A Terminal Ballistic Comparison chart is shown in Appendix IV.

5.2.1 Relative Temporary Cavity Volume

To rank each ammunition type, three different methods of scoring were used. Two methods used the standard deviation from the mean relative volume. Standard deviation was used solely as a means of determining ranges for scoring.

a) The first method simply ranked the four cartridges from largest to smallest relative cavity. After ranking each cartridge for each range, the rankings were totaled and the cartridges were ranked, again, based upon these totals, the cartridge with the smallest total being ranked best.

Simple ranking, from 1 to 4 (lowest is best)

<b>Ballistic Comparison Relative Cavity</b>												
WPN	DODIC	Th=7.3					Tot	Th=9.0				
		10	50	100	300	Tot		10	50	100	300	Tot
Carbine	A059	3	3	3	4	13	2	3	3	4	12	
	AA48	4	4	4	3	15	4	4	4	3	15	
	BLH-2	1	1	2	1	5	1	1	2	2	6	
Rifle	A059	3	3	3	3	12	4	1	3	3	11	
	AA48	4	4	4	4	16	3	2	4	4	13	
	BLH-2	2	1	2	1	6	2	3	2	1	8	

Fig. 2

b) Due to limited deviations in the relative volumes (Vr), the possibility exists that the data may be different if the cartridges were scored based upon volume, then totaled and ranked by the total score. The first method was based upon a 4-point scale:

- i)  $V_r < (\text{Average} - 1 \text{ standard deviation (SD)}) = 4$
- ii)  $(\text{Average} - 1 \text{ SD}) < V_r < \text{Average} = 3$
- iii)  $\text{Average} < V_r < (\text{Average} + 1 \text{ SD}) = 2$
- iv)  $(\text{Average} + \text{SD}) < V_r = 1$

After scoring, results for all four ranges were added together, and the cartridge ranked based upon total score, the smallest being ranked as best.

Relative ranking on a 4-point scale, (lowest is best)

- Below (Average - SD) = 4
- (Average - SD) to Average = 3
- Average to (Average + SD) = 2
- Above (Average + SD) = 1

<b>Ballistic Comparison Total Score</b>												
WPN	DODIC	Th=7.3					Tot	Th=9.0				
		10	50	100	300	10		50	100	300	Tot	
Carbine	A059	2	3	3	3	11	2	2	3	3	10	
	AA48	4	4	3	3	14	4	4	4	3	15	
	BLH-2	2	2	2	1	7	2	2	2	2	8	
Rifle	A059	3	3	3	3	12	3	1	3	3	10	
	AA48	4	4	3	3	14	3	2	3	3	11	
	BLH-2	2	2	2	1	7	3	3	2	2	10	

Fig. 3

c) The second method further separates the data by having the relative volumes (Vr) score on a six-point scale, then adding an extra range based upon 1/2 standard deviation from the mean.

- i)  $V_r < (\text{Average} - 1 \text{ standard deviation (SD)}) = 6$
- ii)  $(\text{Average} - 1 \text{ SD}) < V_r < (\text{Average} - .5 \text{ SD}) = 5$
- ii)  $(\text{Average} - .5 \text{ SD}) < V_r < \text{Average} = 4$
- iii)  $\text{Average} < V_r < (\text{Average} + .5 \text{ SD}) = 3$
- vi)  $(\text{Average} + .5 \text{ SD}) < V_r < (\text{Average} + 1 \text{ SD}) = 2$
- iv)  $(\text{Average} + 1 \text{ SD}) < V_r = 1$

Scores were added similarly, as shown in (b) above, then the cartridges ranked. Results of the evaluation are provided below. Relative ranking on a 6-point scale, (lowest is best)

- Below (Average - SD) = 6
- (Average - SD) to (Average - .5 SD) = 5
- (Average - .5 SD) to Average = 4
- Average to (Average + .5 SD) = 3
- (Average + .5 SD) to (Average + SD) = 2
- Above (Average + SD) = 1

<b>Ballistic Comparison Relative Volume</b>												
WPN	DODIC	Th = 7.3					Tot	Th = 9.0				
		10	50	100	300	10		50	100	300	Tot	
Carbine	A059	3	4	5	5	17	2	3	4	5	14	
	AA48	6	6	5	5	22	6	6	6	5	23	
	BLH-2	2	2	2	1	7	2	2	3	3	10	
Rifle	A059	5	4	5	5	19	5	1	5	5	16	
	AA48	6	6	5	5	22	4	3	5	5	17	
	BLH-2	2	2	2	1	7	4	4	2	2	12	

Fig. 4

5.2.2 Depth to First Yaw

To validate the scoring based on relative volume, the cartridges were ranked based upon depth to first yaw. The average values for all shots of a particular cartridge were calculated and ranked from 1 to 4, the least average depth to first yaw ranked best.

<b>Rank based upon Depth to Initial Yaw (lowest is best)</b>						
<b>WPN</b>	<b>DODIC</b>	10	50	100	300	<b>Tot</b>
Carbine	A059	3	3	3	3	<b>12</b>
	AA48	4	4	4	4	<b>16</b>
	BLH-2	1	1	2	1	<b>5</b>
Rifle	A059	3	3	3	3	<b>12</b>
	AA48	4	3	4	4	<b>15</b>
	BLH-2	1	1	1	1	<b>4</b>

Fig. 5

Photos representative of yaw are enclosed in Appendix (1a thru L).

6.0 CONCLUSIONS & RECOMMENDATIONS

The 77-grain Black Hills Nosler w/cannelure (BLH2) demonstrated superior overall performance with respect to both accuracy and terminal effects. The increased performance was observed in both the M4A1 and the M16A2 throughout all scenarios of engagement range and temperature extremes.

The BLH2 cartridge showed increased performance over the M855. However, the accuracy and terminal ballistic data obtained during this evaluation for both the A059 and AA48 demonstrated that these cartridges performed as expected.

Recommend that an assessment to determine what level, if any, the BLH2 cartridge should be integrated into the Marine Corps small arms inventory. This assessment should include cost differential between each cartridge compared to the increase in cartridge performance. This assessment should also take into account a more diverse spectrum of targets, such as ballistic protective vests, where the M855 and BLH2 performance may be closely matched.

<b>Compiled Results</b>								
<b>WPN</b>	<b>DODIC</b>	Target = 7.3			Target = 9.0			IV
		Scoring Rank	I	II	III	I	II	
Carbine	A059	3	3	3	3	3	3	3
	AA48	4	4	4	4	4	4	4
	BLH-2	<b>1</b>	<b>1</b>	<b>1</b>	<b>1</b>	2	2	<b>1</b>
Rifle	A059	3	3	3	3	2	3	3
	AA48	4	4	4	4	4	4	4
	BLH-2	<b>1</b>	<b>1</b>	<b>1</b>	<b>1</b>	2	2	<b>1</b>

Fig. 6

APPENDIX A

I.a. ACCURACY COMPARISON for M4A1 & M16A2

**M4A1/A059**

Weapon S/N	MR Average				3 Sigma				1 Sigma			
	Ambient	-25	120	All Temps	Ambient	-25	120	All Temps	Ambient	-25	120	All Temps
W325745	3.76	3.77	3.58	3.69	5.23	5.35	6.69	5.76	1.74	1.78	2.23	1.92
W325935	3.51	3.51	3.83	3.83	5.75	5.24	5.77	5.54	1.92	1.75	1.92	1.85
W326152	2.87	3.58	2.95	3.13	4.14	5.24	4.10	4.57	1.38	1.75	1.37	1.52
All Wpns	3.38	3.62	3.45	3.55	5.04	5.23	5.68	5.33	1.68	1.74	1.89	1.78

**M4A1/AA48**

Weapon S/N	MR Average				3 Sigma				1 Sigma			
	Ambient	-25	120	All Temps	Ambient	-25	120	All Temps	Ambient	-25	120	All Temps
W325745	3.00	3.52	3.34	3.28	5.62	4.60	5.62	5.09	1.87	1.53	1.87	1.70
W325935	4.20	2.69	3.48	3.48	7.10	5.58	5.04	6.19	2.37	1.86	1.68	2.06
W326152	3.26	2.67	3.56	3.11	5.19	4.30	6.68	5.35	1.73	1.43	2.23	1.78
All Wpns	3.48	2.96	3.46	3.29	6.22	4.95	5.63	5.63	2.07	1.65	1.88	1.88

**M4A1-BLH2**

Weapon S/N	MR Average				3 Sigma				1 Sigma			
	Ambient	-25	120	All Temps	Ambient	-25	120	All Temps	Ambient	-25	120	All Temps
W325745	2.12	2.03	2.51	2.24	3.11	3.05	3.31	3.26	1.04	1.02	1.10	1.09
W325935	1.96	2.48	2.21	2.21	2.74	3.50	3.86	3.42	0.91	1.17	1.29	1.14
W326152	2.30	1.80	2.36	2.15	4.15	3.70	4.00	3.98	1.38	1.23	1.33	1.33
All Wpns	2.13	2.11	2.36	2.20	3.37	3.89	3.75	3.71	1.12	1.30	1.25	1.24



I.b. ACCURACY COMPARISON for M4A1 & M16A2 (con't)

**M16A2/A059**

Weapon S/N	Average MR				3 Sigma				1 Sigma			
	Ambient	-25	120	All Temps	Ambient	-25	120	All Temps	Ambient	-25	120	All Temps
7305875	3.15	3.14	4.26	3.52	5.23	4.91	6.43	5.57	1.74	1.64	2.14	1.86
7306186	3.37	3.45	4.41	3.75	6.01	4.71	6.41	5.86	2.00	1.57	2.14	1.95
7152905	3.34	3.96	3.59	3.63	4.45	6.37	7.13	6.14	1.48	2.12	2.38	2.05
All Wpns	3.29	3.52	4.09	3.63	5.04	5.42	6.76	5.84	1.68	1.81	2.25	1.95

**M16A2/AA48**

Weapon S/N	Average MR				3 Sigma				1 Sigma			
	Ambient	-25	120	All Temps	Ambient	-25	120	All Temps	Ambient	-25	120	All Temps
7305875	3.51	3.48	3.40	3.47	5.34	5.56	5.82	5.39	1.78	1.85	1.94	1.80
7306186	4.31	4.36	4.03	4.23	8.18	5.72	5.85	6.63	2.73	1.91	1.95	2.21
7152905	3.04	3.36	3.66	3.36	6.07	5.85	4.50	5.48	2.02	1.95	1.50	1.83
All Wpns	3.62	3.73	3.70	3.69	6.77	5.81	5.42	5.99	2.26	1.94	1.81	2.00

**M16A2/BLH2**

Weapon S/N	Average MR				3 Sigma				1 Sigma			
	Ambient	-25	120	All Temps	Ambient	-25	120	All Temps	Ambient	-25	120	All Temps
7305875	2.16	2.83	2.84	2.61	2.69	4.73	5.29	4.49	0.90	1.58	1.76	1.50
7306186	3.24	2.35	3.12	2.90	3.08	3.47	4.86	4.02	1.03	1.16	1.62	1.34
7152905	2.44	2.37	3.58	2.79	3.55	3.86	5.14	4.50	1.18	1.29	1.71	1.50
All Wpns	2.62	2.51	3.18	2.77	3.37	4.15	5.16	4.35	1.12	1.38	1.72	1.45

**II. Accuracy Test Summary**

<b>5.56MM ACCURACY EVALUATION*</b>					
<b>M4A1</b>					
Ctg Type	Mean Radius (MR)	Standard Deviation (SD)	MR + 3SD	Mean Maximum Spread (MMS)	Maximum Spread (MS)
A059	3.55	1.78	8.89	13.78	14.46
AA48	3.29	1.88	8.93	15.96	16.53
BLH2	2.20	1.24	5.91	9.46	10.03
<b>M16A2</b>					
Ctg Type	Mean Radius (MR)	Standard Deviation (SD)	MR + 3SD	Mean Maximum Spread (MMS)	Maximum Spread (MS)
A059	3.63	1.95	9.48	17.92	19.17
AA48	3.69	2.00	9.69	15.00	16.81
BLH2	2.77	1.45	7.12	12.72	14.11

\*All Values in Inches

### III. Wound Cavity Data

Cartridge	Weapon	Range	Muzzle Velocity	Impact Velocity	Depth to Yaw	Temp Cavity Length	Max Cavity Height	Max Cavity Width	Depth to Max Height	Total Cavity Volume	Relative Volume Th = 7.3	Relative Volume Th = 9.0
A059	Carbine	10M	2878	2865	2.75	10.25	5.65	4.00	5.35	60.6	<b>41.9</b>	54.2
AA48		10M	2960	2947	3.40	12.85	5.20	4.05	7.25	70.8	<b>22.0</b>	44.9
BLH-2		10M	2711	2698	1.45	9.05	4.95	4.85	5.45	56.9	<b>48.8</b>	56.0
A059	Rifle	10M	3108	3092	3.05	9.80	5.65	4.40	6.35	63.8	<b>37.4</b>	55.0
AA48		10M	3125	3109	3.30	10.45	5.20	5.25	7.25	74.6	<b>29.3</b>	56.5
BLH-2		10M	2848	2833	0.95	8.30	5.15	5.10	4.80	57.0	<b>54.5</b>	57.0
A059	Carbine	50M	2893	2761	2.55	8.70	4.00	4.50	7.50	41.0	<b>22.4</b>	37.2
AA48		50M	2920	2783	4.15	13.05	4.70	3.60	8.95	57.8	<b>6.0</b>	21.9
BLH-2		50M	2668	2545	1.50	7.70	4.50	4.50	5.90	40.8	<b>37.5</b>	40.8
A059	Rifle	50M	3155	3016	3.10	8.30	5.60	4.85	7.35	59.0	<b>29.9</b>	53.0
AA48		50M	3171	3020	3.10	10.77	5.80	4.70	8.15	76.9	<b>20.7</b>	51.6
BLH-2		50M	2828	2710	1.15	7.85	4.90	4.95	5.40	49.8	<b>47.4</b>	49.8
A059	Carbine	100M	2869	2569	4.10	10.45	4.20	3.90	8.85	44.8	<b>6.2</b>	22.2
AA48		100M	2853	2556	4.45	13.05	3.90	3.60	9.30	47.9	<b>3.6</b>	14.7
BLH-2		100M	2638	2377	1.95	7.95	4.05	3.40	5.15	28.6	<b>25.8</b>	28.5
A059	Rifle	100M	3093	2799	5.05	8.90	4.60	4.95	9.70	53.0	<b>3.1</b>	17.0
AA48		100M	3072	2764	5.50	12.45	4.75	3.10	8.90	48.0	<b>1.9</b>	14.2
BLH-2		100M	2833	2544	1.55	7.70	4.05	4.15	5.35	33.9	<b>31.7</b>	33.9
A059	Carbine	300M	2856	1949	3.90	11.45	2.80	2.30	10.80	19.3	<b>1.4</b>	4.7
AA48		300M	2855	1927	4.65	11.80	3.30	2.55	9.90	26.0	<b>1.5</b>	6.6
BLH-2		300M	2650	1859	2.65	6.60	3.05	3.00	5.50	15.8	<b>14.5</b>	15.8
A059	Rifle	300M	3078	2155	5.45	11.00	3.15	2.40	9.85	21.8	<b>0.6</b>	4.6
AA48		300M	3085	2139	5.70	11.45	3.10	2.10	11.85	19.5	<b>0.2</b>	1.6
BLH-2		300M	2831	2039	1.50	8.60	3.55	3.00	5.25	24.0	<b>21.4</b>	23.8

IV. Terminal Effects

**5.56MM TERMINAL BALLISTIC COMPARISON**

<b>10M</b>					<b>100M</b>				
	M4A1		M16A2			M4A2		M16A2	
	in.	%*	in.	%*		in.	%*	in.	%*
<i>Depth to Yaw</i>					<i>Depth to Yaw</i>				
A059	2.75	0.0	3.05	0.0	A059	4.10	0.0	5.05	0.0
AA48	3.40	23.6	3.30	8.2	AA48	4.45	8.5	5.50	8.9
BLH2	<b>1.45</b>	<b>-47.3</b>	<b>0.95</b>	<b>-68.9</b>	BLH2	<b>1.95</b>	<b>-52.4</b>	<b>1.55</b>	<b>-69.3</b>
<i>Relative Volume (7.3)</i>	Cu. In.	%*	Cu. In.	%*	<i>Relative Volume (7.3)</i>	Cu. In.	%*	Cu. In.	%*
A059	41.9	0.0	37.4	0.0	A059	6.2	0.0	3.1	0.0
AA48	22.0	-47.5	29.3	-30.1	AA48	3.6	-41.9	1.9	-38.7
BLH2	<b>48.8</b>	<b>16.5</b>	<b>54.5</b>	<b>30.1</b>	BLH2	<b>25.8</b>	<b>316.1</b>	<b>31.7</b>	<b>922.6</b>
<i>Relative Volume (9.0)</i>	Cu. In.	%*	Cu. In.	%*	<i>Relative Volume (9.0)</i>	Cu. In.	%*	Cu. In.	%*
A059	54.2	0.0	55.0	0.0	A059	22.2	0.0	17.0	0.0
AA48	44.9	-17.2	56.5	2.7	AA48	14.7	-33.8	14.2	-16.5
BLH2	<b>56.0</b>	<b>3.3</b>	<b>57.0</b>	<b>3.6</b>	BLH2	<b>28.5</b>	<b>28.4</b>	<b>33.9</b>	<b>99.4</b>

<b>50M</b>					<b>300M</b>				
	M4A1		M16A2			M4A1		M16A2	
	in.	%*	in.	%*		in.	%*	in.	%*
<i>Depth to Yaw</i>					<i>Depth to Yaw</i>				
A059	2.55	0.0	3.10	0.0	A059	3.90	0.0	5.45	0.0
AA48	4.15	62.7	3.10	0.0	AA48	4.65	19.2	5.70	4.6
BLH2	<b>1.50</b>	<b>-41.2</b>	<b>1.15</b>	<b>-62.9</b>	BLH2	<b>2.65</b>	<b>-32.1</b>	<b>1.15</b>	<b>-78.9</b>
<i>Relative Volume (7.3)</i>	Cu. In.	%*	Cu. In.	%*	<i>Relative Volume (7.3)</i>	Cu. In.	%*	Cu. In.	%*
A059	22.4	0.0	29.9	0.0	A059	1.4	0.0	0.6	0.0
AA48	6.0	-73.2	20.7	-30.8	AA48	1.5	7.1	0.2	-66.7
BLH2	<b>37.5</b>	<b>67.4</b>	<b>47.4</b>	<b>58.5</b>	BLH2	<b>14.5</b>	<b>935.7</b>	<b>21.4</b>	<b>3466.7</b>
<i>Relative Volume (9.0)</i>	Cu. In.	%*	Cu. In.	%*	<i>Relative Volume (9.0)</i>	Cu. In.	%*	Cu. In.	%*
A059	37.2	0.0	<b>53.0</b>	<b>0.0</b>	A059	4.7	0.0	4.6	0.0
AA48	21.9	-41.1	51.6	-2.6	AA48	6.6	40.4	1.6	-65.2
BLH2	<b>40.8</b>	<b>9.7</b>	49.8	-6.0	BLH2	<b>15.8</b>	<b>236.2</b>	<b>23.4</b>	<b>408.7</b>

\*Percentages normalized to A059 values  
**BOLD** numbers indicate best value for series

# **EXHIBIT 3**

# Product Manager

## Small Caliber Ammunition

### M855A1 Enhanced Performance Round (EPR)



Distribution Statement A:  
Approved for Public Release; Distribution is unlimited. Other requests shall be referred to the Office of the Project Manager for Maneuver Ammunition Systems, ATTN: SFAE-AMO-MAS-SETI, Picatinny, NJ 07806-5000

LTC Jeffrey K. Woods  
Product Manager  
Small Caliber Ammunition





# M855A1 EPR Benefits

## Performance Benefits

- Dramatically improves hard target performance
- Provides improved, consistent effects against soft targets and CQB performance
- Significantly increases range of consistent effects against soft targets
- —Matb” like accuracy – VERY ACCURATE
- No weight increase, improved propellant, reduced flash
- Trajectory Match—no Soldier training transfer difference
- Significant performance improvements in a 5.56mm
  - Surpassed 7.62mm ball against soft targets
  - Hard target performance (steel) far better than 7.62mm ball
- Extremely effective against ALL target sets ( a true, general purpose round)
- Lead free projectile





# Army Requirements for General Purpose Ammunition



## Performance Measures

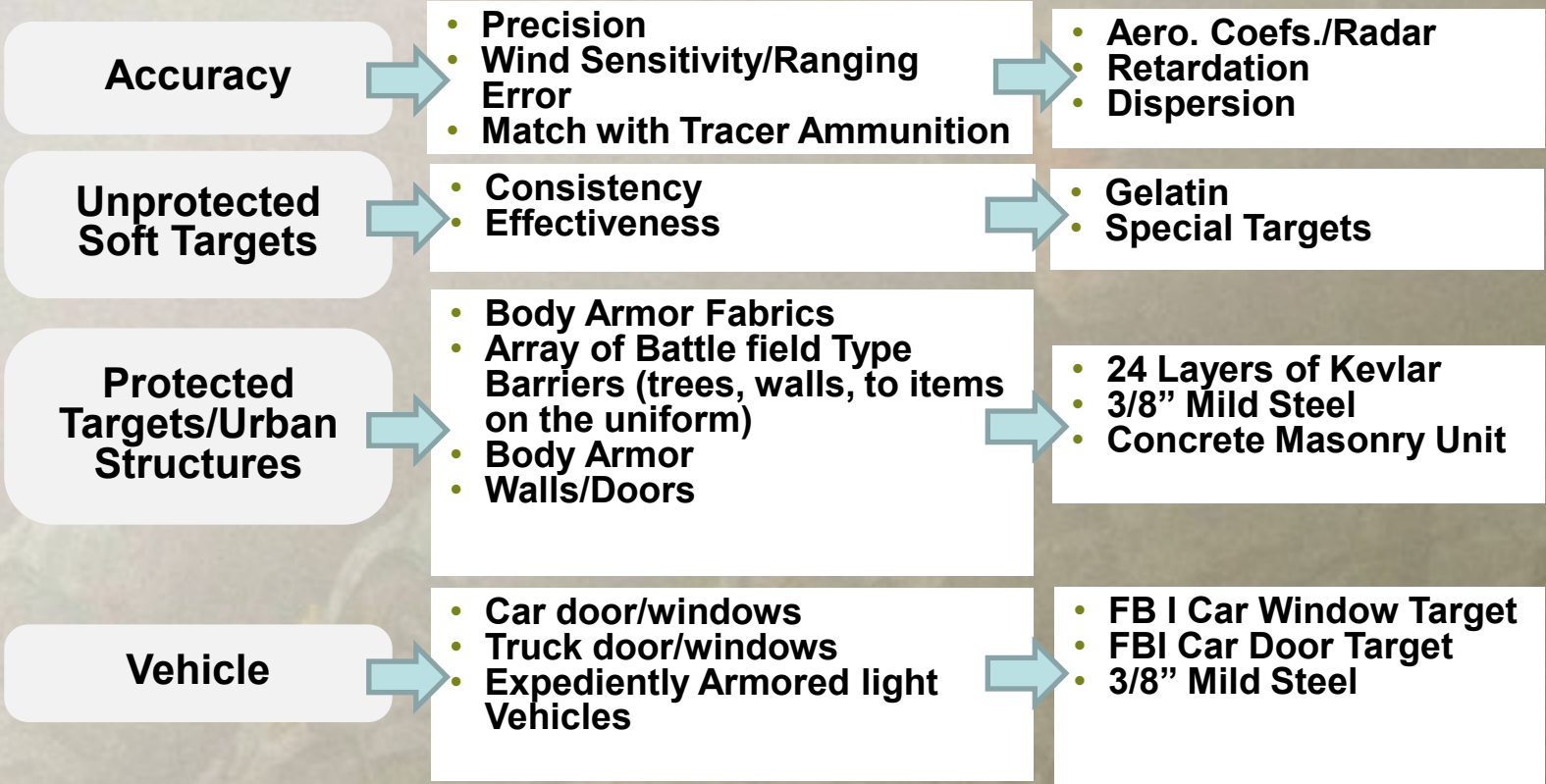

**Must be able to engage a wide array of targets**





# Comparison of Changes

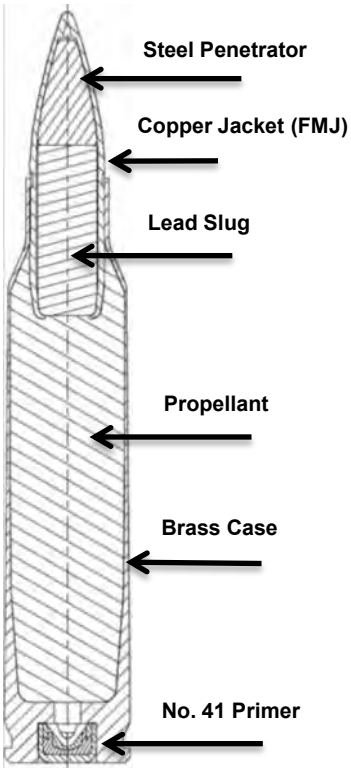

Characteristic	M855	EPR
Cartridge Length	2.248 in	No Change
Bullet Weight	62gr	No Change
Tip ID	Green	Bronze from Corrosion Protection
Slug	Lead	Copper
Cup/Jacket	Copper	No Change
Penetrator	Steel	Steel Arrow Head
Corrosion Resistance	None	Yes
Propellant	WC-844	SMP-842
Flash Suppressant	No	Yes
De-Coppering Agent	No	Yes
Velocity	3113 ft/s	Increased
Chamber Pressure	M855 Spec	Increased
Penetration	3/8" Mild Steel @ 160m	3/8" Mild Steel @ 350m
Soft Target	Not Specified	Improved Consistency and Range

M855A1

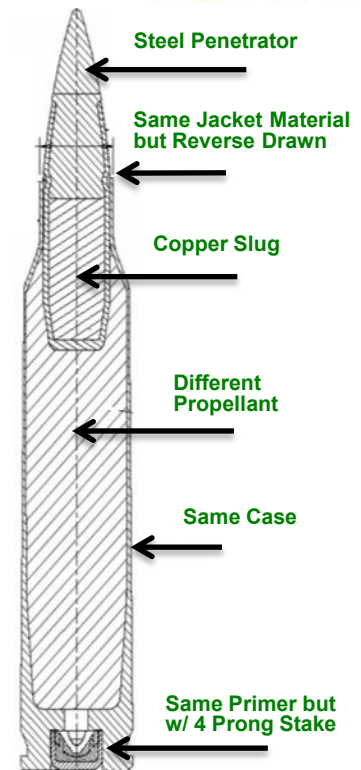
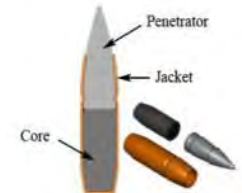



# Improved Consistent Effects

**The M855A1 does NOT rely on yaw for its effects**

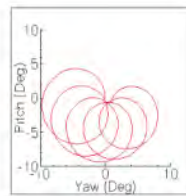
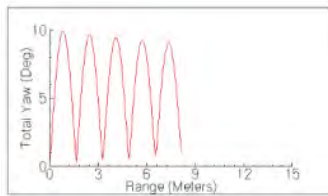
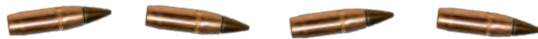

**Yaw and pitch change with range, often providing inconsistent effects for previous ammunition**

- The M855A1 is NOT yaw dependant
- Regardless of angle of yaw or pitch, the M855A1 provides the same consistent performance against soft targets
- This performance remains consistent for the Soldier, whether firing in close quarters or long range engagements
- The M855A1 greatly increases the maximum range at which a Soldier armed with the M4 or M16 can generate these consistent effects
- Army Research Lab live fire test results against soft targets showed that on average, the EPR surpassed the 7.62mm ball round

**M855A1 Provides Consistent Performance, Every Time!**



# Comparison of M855A1 and M855

		M855A1	M855
Soft Target	Consistent Effects	G	R
Barriers	Car Window	G	G
	Car Door	G	G
	3/8" Steel	G	Y
	Concrete Masonry Unit	Y	R
	Soft Body Armor (24 layer Kevlar)	G	G
Accuracy	Wind Drift	G	G
	Ranging Error	G	G
	MOA	G	Y
	Dispersion	G	G
	Trajectory Match with M856 (Trace)	G	G
Propellant	Velocity	G	Y
	Temperature Coefficient	Y	Y
	Flash Suppression	G	R

M855 remains a VERY capable, all purpose round!



M855A1 Enhanced Performance Round

*Chart colors are for comparison only, both rounds meet their respective requirements.*



# M855 and M855A1 Trajectories

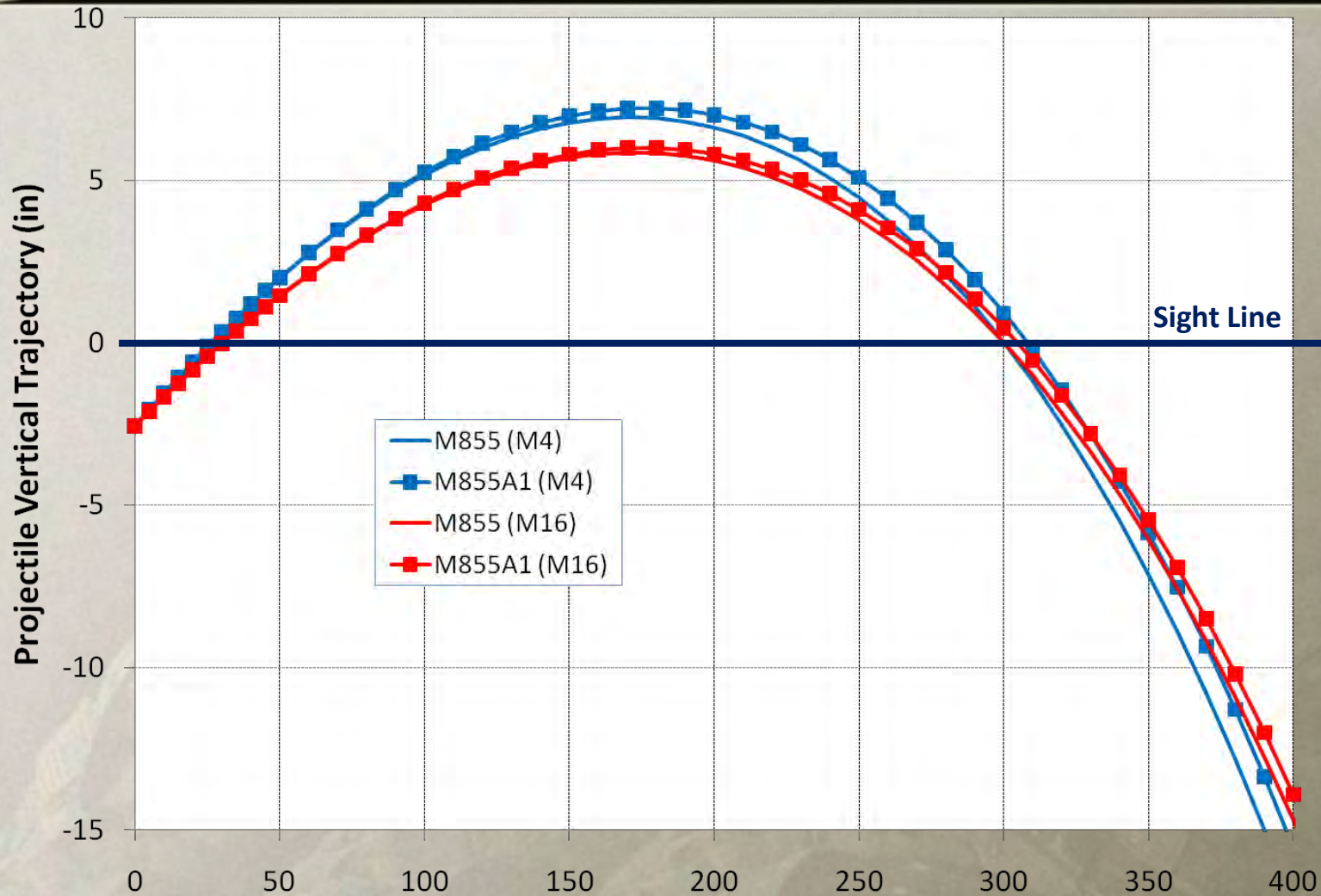

**Trajectory Match to the M855**



# M855A1 Intermediate Barrier Performance

## Car Door



**Provides Desired Effects Against Targets Behind Intermediate Barriers**

## Windshield

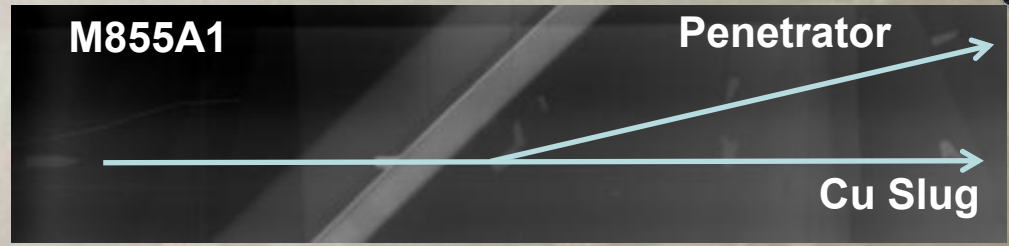

**M855A1 Hits the Target Behind Windshields with the Steel Penetrator and/or Copper Slug, Increasing Probability of a Hit**



# M855A1 Penetration

3/8" Mild Steel

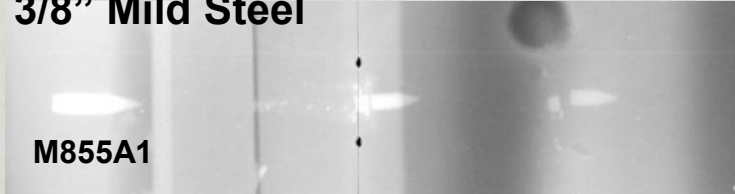

M855A1



350m

Shot with the M4



**M80, 7.62mm can't penetrate at these ranges**



Kevlar Fabric



M855A1

M855A1 was tested out to 1000m and was never stopped.

**M855A1 WILL Penetrate Some Types of Body Armor Designed to Stop 7.62mm Ball**



# M855A1 Hard Target Performance

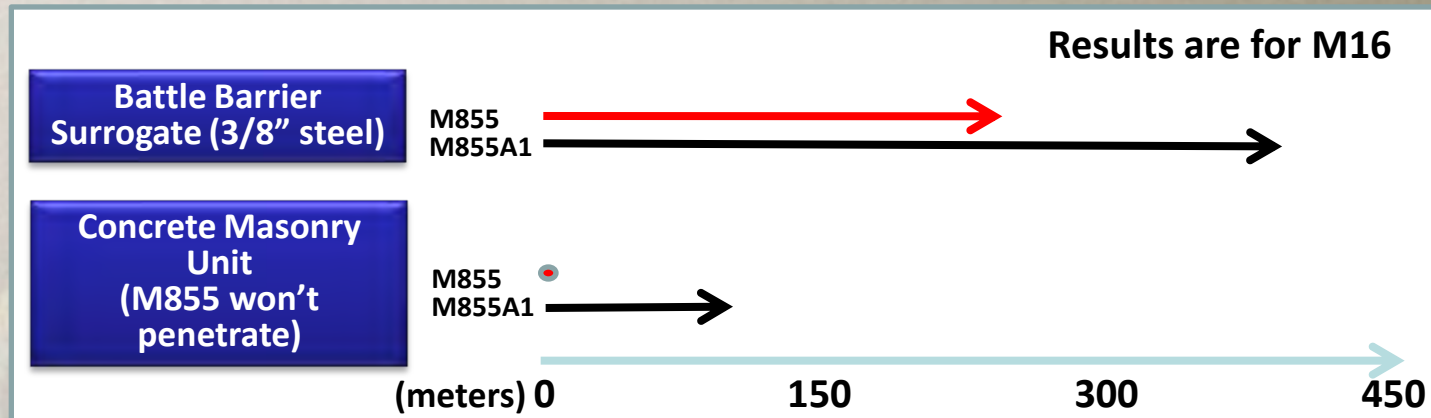
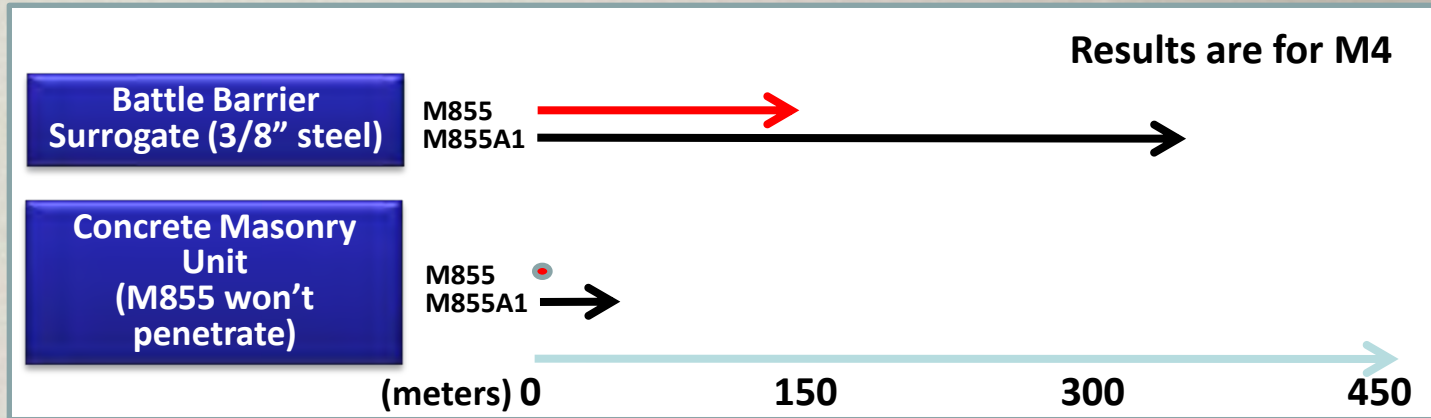

**M855A1 has Significantly Improved Hard Target Performance**

# EPR Accuracy



- Accuracy testing\* shows that on average, 95% of rounds will hit within a eight by eight inch target at a range of 600 yards
- While ammunition accuracy is important, nothing replaces good marksmanship training.

600 Yards →

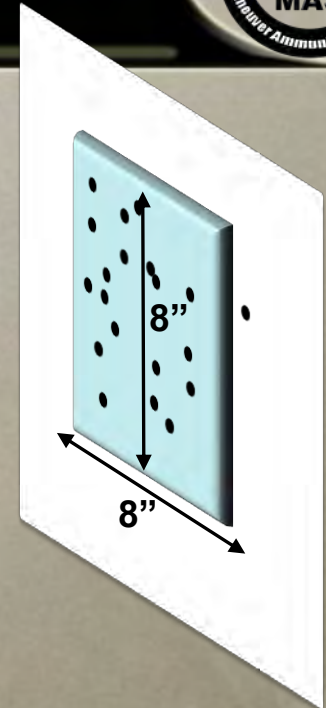

**Shot Placement is still the most important factor!**





# M855A1 Enhanced Performance Round

## ■ What all Soldiers need to know when using this round

- Dramatically improves hard target performance
- Provides dependable, consistent effects against soft targets and CQB performance
- Significantly improves performance at extended ranges
- **–Match” like accuracy – VERY ACCURATE**
- No weight increase, flash reduced, increased velocity
- Extremely effective against a wide variety of targets (a true all purpose small caliber round)
- Not yet approved for use with the GREM or the M249
- A noticeable gap below the penetrator or **–spinning” tips** are normal and do not impede performance in any way

Bronze Colored Tip

Noticeable Gap Beneath Penetrator



–M855A1 EPR





# Take-a-ways

- **M855A1 Enhanced Performance Round (EPR)**
  - Represents a significant performance improvement in a 5.56mm bullet
    - Hard target performance (steel) far better than 7.62mm ball
    - Surpassed 7.62mm ball against soft targets
  - A true general purpose round optimized to a wide array of targets
  - Significantly improved hard target performance at longer distances
  - Provides consistent performance against soft targets (Yaw sensitivity)
  - Significantly increases range of consistent effects against soft targets
  - Lead free projectile
  - Planned to replace M855 for the Army
  - Fielding in summer 2010

**Continuing to Provide Improved Capabilities for our Warfighters!**

# **EXHIBIT 4**

TC 3-22.9

---

---

# Rifle and Carbine

---

---

**MAY 2016**

★ **Distribution Restriction: Approved for public release;  
distribution is unlimited.**

\*This publication supersedes FM 3-22.9, 12 August 2008.

---

---

**Headquarters, Department of the Army**

---

---

This publication is available at the Army Publishing Directorate site  
(<http://www.apd.army.mil>), and the Central Army Registry site  
(<https://atiam.train.army.mil/catalog/dashboard>).

**TC 3-22.9, C3**

Change 3

Headquarters  
Department of the Army  
Washington, DC, 20 November 2019

## Rifle and Carbine

1. Change TC 3-22.9, 13 May 2016, as follows:

**Remove old pages:**

iii through x  
1-1 through 1-9  
F-1 through F-22  
References-1 through References-2  
Index-1

**Insert new pages:**

iii through ix  
1-1 through 1-13  
F-1 through F-10  
References-1 through References-2  
Index-1

2. A triangle (  ) marks new or changed material.
3. File this transmittal sheet in front of the publication.

**DISTRIBUTION RESTRICTION:** Approved for public release; distribution is unlimited.

**TC 3-22.9**  
**20 November 2019**

By Order of the Secretary of the Army:

**JAMES C. MCCONVILLE**  
*General, United States Army*  
*Chief of Staff*

Official:

  
**KATHLEEN S. MILLER**  
*Administrative Assistant*  
*to the Secretary of the Army*  
1931911

**DISTRIBUTION:**

*Active Army, Army National Guard, and United States Army Reserve: To be distributed in accordance with the initial distribution number (IDN) 110187, requirements for TC 3-22.9.*

**PIN: 106419-003**

**TC 3-22.9, C2**

Change 2

Headquarters  
Department of the Army  
Washington, DC, 31 August 2017

## Rifle and Carbine

1. Change TC 3-22.9, 13 May 2016, as follows:

**Remove old pages:**

cover  
i through x  
3-7 through 3-8  
3-15 through 3-16  
8-11 through 8-12  
E-5 through E-6  
F-11 through F-12

Glossary-3  
References-1 to References-2

**Insert new pages:**

cover  
i through x  
3-7 through 3-8  
3-15 through 3-16  
8-11 through 8-12  
E-5 through E-6  
F-11 through F-12  
G-1 through G-10  
Glossary-3  
H-References-1 to References-2

2. A star (  ) marks new or changed material.
3. File this transmittal sheet in front of the publication.



**DISTRIBUTION RESTRICTION:** Approved for public release, distribution is unlimited.



**TC 3-22.9, C2**  
31 August 2017

By Order of the Secretary of the Army:

**MARK A. MILLEY**  
*General, United States Army*  
*Chief of Staff*

Official:

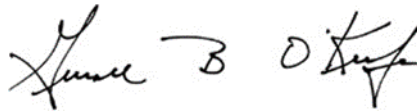

**GERALD B. O'KEEFE**  
*Administrative Assistant to the*  
*Secretary of the Army*  
1723501

**DISTRIBUTION:**

*Active Army, Army National Guard, and U.S. Army Reserve.* To be distributed in accordance with the initial distribution number (IDN) 110187, requirements for TC 3-22.9.

**PIN: 106419-002**



This page intentionally left blank.



**TC 3-22.9, C1**

Change 1

Headquarters  
Department of the Army  
Washington, DC, 10 January 2017

## Rifle and Carbine

1. Change TC 3-22.9, 13 May 2016, as follows:

**Remove old pages:**

iii through viii  
3-13 through 3-14  
3-15 through 3-16  
7-7 through 7-20  
8-1 through 8-2  
A-9 through A-10

References-2 to References-3  
Index-1 to Index-2

**Insert new pages:**

iii through viii  
3-13 through 3-14  
3-15 through 3-16  
7-7 through 7-20  
8-1 through 8-2  
A-9 through A-10  
F-1 through F-22  
References-2 to References-3  
Index-1 to Index-2

2. A bar (|) marks new or changed material.
3. File this transmittal sheet in front of the publication.

**DISTRIBUTION RESTRICTION A:** Approved for public release; distribution is unlimited.

**DESTRUCTION NOTICE:** Destroy by any method that will prevent disclosure of contents or reconstruction of the document.

**TC 3-22.9, C1**  
10 January 2017

By Order of the Secretary of the Army:

**MARK A. MILLEY**  
*General, United States Army*  
*Chief of Staff*

Official:



**GERALD B. O'KEEFE**  
*Administrative Assistant to the*  
*Secretary of the Army*  
1612002

**DISTRIBUTION:**

*Active Army, Army National Guard, and U.S. Army Reserve. To be distributed in accordance with the initial distribution number (IDN) 110187, requirements for TC 3-22.9.*

**106419-001**

This page intentionally left blank.

## TC 3-22.9 (FM 3-22.9)

\*Training Circular  
No. 3-22.9

Headquarters  
Department of the Army  
Washington, DC, 13 May 2016

# Rifle and Carbine

## Contents

	Page
<b>PREFACE</b> .....	viii
<b>INTRODUCTION</b> .....	ix
<b>Chapter 1 OVERVIEW</b> .....	<b>1-1</b>
Safe Weapons Handling .....	1-2
Rules of Firearms Safety.....	1-2
Weapon Safety Status .....	1-4
Weapons Control Status .....	1-10
Overmatch .....	1-10
<b>Chapter 2 RIFLE AND CARBINE PRINCIPLES OF OPERATION</b> .....	<b>2-1</b>
Army Standard Service Rifle .....	2-1
Upper Receiver .....	2-2
Lower Receiver .....	2-3
Cycle of Function .....	2-4
Cooling.....	2-13
<b>Chapter 3 AIMING DEVICES</b> .....	<b>3-1</b>
Units of Angular Measurement.....	3-2
Optics.....	3-8
Thermal Sights.....	3-15
Pointers / Illuminators / Lasers .....	3-19
<b>Chapter 4 MOUNTABLE EQUIPMENT</b> .....	<b>4-1</b>
Adaptive Rail System .....	4-1
Mountable Weapons .....	4-2
Mountable Aiming Devices.....	4-4
Mountable Accessories .....	4-5

**Distribution Restriction: Approved for public release, distribution is unlimited.**

**\*This publication supersedes FM 3-22.9, 12 August 2008.**

**Contents**

---

<b>Chapter 5</b>	<b>EMPLOYMENT</b> .....	<b>5-1</b>
	Shot Process.....	5-2
	Functional Elements of the Shot Process .....	5-3
	Target Acquisition .....	5-4
<b>Chapter 6</b>	<b>STABILITY</b> .....	<b>6-1</b>
	Support .....	6-1
	Muscle Relaxation.....	6-4
	Natural Point of Aim .....	6-4
	Recoil Management .....	6-5
	Shooter–Gun Angle .....	6-5
	Field of View .....	6-5
	Carry Positions.....	6-6
	Stabilized Firing .....	6-13
	Firing Positions .....	6-15
<b>Chapter 7</b>	<b>AIM</b> .....	<b>7-1</b>
	Common Engagements .....	7-1
	Common Aiming Errors.....	7-5
	Complex Engagements.....	7-6
	Target Conditions.....	7-10
	Environmental Conditions .....	7-16
<b>Chapter 8</b>	<b>CONTROL</b> .....	<b>8-1</b>
	Trigger Control .....	8-2
	Breathing Control.....	8-4
	Workspace Management .....	8-4
	Calling the Shot.....	8-5
	Rate of fire .....	8-6
	Follow-Through .....	8-7
	Malfunctions.....	8-8
	Transition to Secondary Weapon.....	8-14
<b>Chapter 9</b>	<b>MOVEMENT</b> .....	<b>9-1</b>
	Movement Techniques.....	9-1
	Forward Movement .....	9-2
	Retrograde Movement .....	9-2
	Lateral Movement .....	9-3
	Turning Movement .....	9-4
<b>Appendix A</b>	<b>AMMUNITION</b> .....	<b>A-1</b>
<b>Appendix B</b>	<b>BALLISTICS</b> .....	<b>B-1</b>
<b>Appendix C</b>	<b>COMPLEX ENGAGEMENTS</b> .....	<b>C-1</b>
<b>Appendix D</b>	<b>DRILLS</b> .....	<b>D-1</b>
<b>Appendix E</b>	<b>ZEROING</b> .....	<b>E-1</b>

**Contents**

---

 **Appendix F 10-METER BORESIGHT OFFSETS AND 25-METER ZERO**



**Glossary ..... Glossary-1**

**References ..... References-1**

**Index ..... Index-1**

## **Figures**

Figure 1-1. Employment skills ..... 1-1

Figure 1-2. Small unit range overmatch ..... 1-12

Figure 2-1. Upper receiver..... 2-2

Figure 2-2. Lower receiver..... 2-3

Figure 2-3. Feeding example..... 2-5

Figure 2-4. Chambering example ..... 2-6

Figure 2-5. Locking example ..... 2-7

Figure 2-6. Firing example..... 2-8

Figure 2-7. Unlocking example..... 2-9

Figure 2-8. Extraction example ..... 2-10

Figure 2-9. Ejection example..... 2-11

Figure 2-10. Cocking example ..... 2-12

Figure 3-1. Minute of angle example ..... 3-2

Figure 3-2. Mil example ..... 3-3

Figure 3-3. Close combat optic / Rifle combat optic reticle /  
Thermal reticle examples ..... 3-4

Figure 3-4. Stadia reticle example..... 3-5

Figure 3-5. Electromagnetic spectrum ..... 3-7

Figure 3-6. Carrying handle with iron sight example ..... 3-9

Figure 3-7. Back up iron sight ..... 3-10

Figure 3-8. CCO Reticle, Comp M2 examples ..... 3-12

Figure 3-9. RCO reticle example ..... 3-14

Figure 3-10. Thermal weapon sight example ..... 3-15

Figure 3-11. Weapon thermal sights by version..... 3-17

Figure 3-12. Thermal weapons sight, narrow field of view reticle  
example..... 3-18

Figure 3-13. Thermal weapons sight, wide field of view reticle  
example..... 3-18



**Contents**

---

Figure 3-14. AN/PEQ-2 ..... 3-21

Figure 3-15. AN/PEQ-15, ATPIAL ..... 3-23

Figure 3-16. AN/PEQ-15A, DBAL-A2 ..... 3-25

Figure 3-17. AN/PSQ-23, STORM ..... 3-27

Figure 4-1. M320 attached to M4 series carbine example ..... 4-2

Figure 4-2. M203 grenade launcher example ..... 4-2

Figure 4-3. M26 shotgun example ..... 4-3

Figure 4-4. Bipod example ..... 4-5

Figure 4-5. Vertical foregrip example ..... 4-6

Figure 6-1. Stock weld ..... 6-4

Figure 6-2. Hang carry example ..... 6-7

Figure 6-3. Safe hang example ..... 6-8

Figure 6-4. Collapsed low ready example ..... 6-9

Figure 6-5. Low ready position ..... 6-10

Figure 6-6. High ready position ..... 6-11

Figure 6-7. Ready position or up position ..... 6-12

Figure 6-8. Firing position stability example ..... 6-14

Figure 6-9. Standing, unsupported example ..... 6-16

Figure 6-10. Standing, supported example ..... 6-17

Figure 6-11. Squatting position ..... 6-18

Figure 6-12. Kneeling, unsupported example ..... 6-19

Figure 6-13. Kneeling, supported example ..... 6-20

Figure 6-14. Sitting position—crossed ankle ..... 6-21

Figure 6-15. Sitting position—crossed-leg ..... 6-22

Figure 6-16. Sitting position—open leg ..... 6-23

Figure 6-17. Prone, unsupported example ..... 6-24

Figure 6-18. Prone, supported example ..... 6-25

Figure 6-19. Prone, roll-over example ..... 6-26

Figure 6-20. Reverse roll-over prone firing position ..... 6-27

Figure 7-1. Horizontal weapon orientation example ..... 7-2

Figure 7-2. Vertical weapons orientation example ..... 7-3

Figure 7-3. Front sight post/reticle aim focus ..... 7-4

Figure 7-4. Immediate hold locations for windage and lead  
example ..... 7-8

Figure 7-5. Immediate hold locations for elevation (range) example ..... 7-9

**Contents**

Figure 7-6. Front sight post method example..... 7-11  
Figure 7-7. Immediate holds for range to target..... 7-13  
Figure 7-8. Immediate holds for moving targets example ..... 7-14  
Figure 7-9. Oblique target example ..... 7-15  
Figure 7-10. Wind value ..... 7-17  
Figure 7-11. Wind effects ..... 7-18  
Figure 7-12. Wind hold example ..... 7-19  
Figure 8-1. Arc of movement example ..... 8-2  
Figure 8-2. Natural trigger finger placement..... 8-3  
Figure 8-3. Workspace example ..... 8-5  
Figure 8-4. Malfunction corrective action flow chart ..... 8-12  
Figure A-1. Small arms ammunition cartridges ..... A-1  
Figure A-2. Cartridge case ..... A-2  
Figure A-3. Propellant..... A-3  
Figure A-4. 5.56mm primer detail ..... A-4  
Figure A-5. Bullet example, Armor-piercing cartridge ..... A-5  
Figure A-6. Ball cartridge..... A-6  
Figure A-7. Ball with tracer cartridge ..... A-6  
Figure A-8. Armor-piercing cartridge ..... A-7  
Figure A-9. Short range training ammunition cartridge ..... A-7  
Figure A-10. Blank cartridge..... A-8  
Figure A-11. Close combat mission capability kit cartridge..... A-8  
Figure A-12. Dummy cartridge ..... A-9  
Figure B-1. Internal ballistic terms..... B-2  
Figure B-2. External ballistic terms..... B-3  
Figure B-3. Trajectory..... B-4  
Figure B-4. Lethal zone example ..... B-11  
Figure C-1. Mil Relation Formula example..... C-2  
Figure C-2. Standard dismount threat dimensions example ..... C-3  
Figure C-3. RCO range determination using the bullet drop compensator reticle..... C-4  
Figure C-4. Reticle relationship using a stadiametric reticle example..... C-5  
Figure C-5. Deliberate lead formula example..... C-7

**Contents**

---

	Figure C-6. Deliberate trapping method example .....	C-8
	Figure C-7. Oblique target example .....	C-9
	Figure C-8. Wind value .....	C-11
	Figure C-9. Wind effects .....	C-12
	Figure C-10. Wind formula and ballistics chart example .....	C-14
	Figure C-11. Hold-off example .....	C-15
	Figure C-12. Quick high angle formula example.....	C-17
	Figure C-13. Compound wind and lead determination example.....	C-18
	Figure E-1. Wind effects on zero at 300 meters .....	E-3
	Figure E-2. M16A2 / M16A4 weapons 25m zero target.....	E-5
	Figure E-3. M4-/M16-series weapons 25m zero short range and pistol marksmanship target.....	E-6
	Figure E-4. Grouping.....	E-7
	Figure E-5. Marking shot groups.....	E-8
	Figure E-6a. Horizontal diagnostic shots .....	E-12
	Figure E-6b. Vertical diagnostic shots .....	E-13
△	Figure F-1. 10-meter target offset symbols.....	F-2
△	Figure F-2. Blank 10-meter target offset.....	F-3
△	Figure F-3. M16A2 10-meter boresighting target.....	F-4
△	Figure F-4. 300-meter zero of the advanced combat optical gunsight .....	F-9
△	Figure F-5. Advanced combat optical gunsight points of aim (100 to 300 meters).....	F-10

**Tables**

Table 1-1. General safe condition of the weapon for each weapon safety status.....	1-4
Table 1-2. Weapons Control Status.....	1-10
Table 2-1. Model Version Firing Methods Comparison .....	2-4
Table 3-1. Laser Aiming Devices for the M4 and M16.....	3-19
Table 4-1. Attachment Related Technical Manuals and Mounting .....	4-4
Table 5-1. Shot Process example .....	5-2
Table A-1. Small Arms Color Coding and Packaging Markings .....	A-10
Table A-2. 5-56mm, M855, Ball .....	A-11

**Contents**

---

Table A-3. 5.56mm, M855A1, Enhanced Performance Round (EPR), Ball .....	A-12
Table A-4. 5.56mm, M856A1, Tracer .....	A-13
Table A-5. 5.56mm, Mk301, MOD 0, DIM Tracer.....	A-14
Table A-6. 5.56mm, M995, Armor Piercing .....	A-15
Table A-7. 5.56mm, M862, Short Range Training Ammunition .....	A-16
Table A-8. 5.56mm, M1037, Short Range Training Ammunition .....	A-17
Table A-9. 5.56mm, M1042 Close Combat Mission Capability Kit .....	A-18
Table A-10. 5.56mm, M200, Blank .....	A-19
△ Table C-1. Standard holds beyond zero distance example .....	C-16
Table F-1. Offset mounting .....	F-5

## Preface

Training Circular (TC) 3-22.9 provides Soldiers with the critical information for their rifle or carbine and how it functions, its capabilities, the capabilities of the optics and ammunition, and the application of the functional elements of the shot process.

TC 3-22.9 uses joint terms where applicable. Selected joint and Army terms and definitions appear in both the glossary and the text. Terms for which TC 3-22.9 is the proponent publication (the authority) are italicized in the text and are marked with an asterisk (\*) in the glossary. Terms and definitions for which TC 3-22.9 is the proponent publication are boldfaced in the text. For other definitions shown in the text, the term is italicized and the number of the proponent publication follows the definition.

The principal audience for TC 3-22.9 is all members of the profession of arms. Commanders and staffs of Army headquarters serving as joint task force or multinational headquarters should also refer to applicable joint or multinational doctrine concerning the range of military operations and joint or multinational forces. Trainers and educators throughout the Army will also use this publication.



Commanders, staffs, and subordinates ensure that their decisions and actions comply with applicable United States, international, and in some cases host-nation laws and regulations. Commanders at all levels ensure that their Soldiers operate in accordance with the law of war and the rules of engagement. (See FM 6-27/MCTP 11-10C.)

This publication applies to the active Army, the Army National Guard (ARNG)/Army National Guard of the United States (ARNGUS), and the United States Army Reserve (USAR). Unless otherwise stated in this publication, masculine nouns and pronouns do not refer exclusively to men.

Uniforms depicted in this manual were drawn without camouflage for clarity of the illustration.

The proponent of this publication is United States (U.S.) Army Maneuver Center of Excellence (MCoE). The preparing agency is the MCoE, Fort Benning, Georgia. You may submit comments and recommended changes in any of several ways—U.S. mail, e-mail, fax, or telephone—as long as you use or follow the format of DA Form 2028, (*Recommended Changes to Publications and Blank Forms*). Contact information is as follows:

E-mail: usarmy.benning.mcoe.mbx.doctrine@mail.mil  
Phone: COM 706-545-7114 or DSN 835-7114  
Fax: COM 706-545-8511 or DSN 835-8511  
U.S. mail: Commander, MCoE  
Directorate of Training and Doctrine (DOTD)  
Doctrine and Collective Training Division  
ATTN: ATZB-TDD  
Fort Benning, GA 31905-5410

## **Introduction**

This manual is comprised of nine chapters and five appendices, and is specifically tailored to the individual Soldier's use of the M4- or M16-series weapon. This TC provides specific information about the weapon, aiming devices, attachments, followed by sequential chapters on the tactical employment of the weapon system.

The training circular itself is purposely organized in a progressive manner, each chapter or appendix building on the information from the previous section. This organization provides a logical sequence of information which directly supports the Army's training strategy for the weapon at the individual level.

Chapters 1 through 4 describe the weapon, aiming devices, mountable weapons, and accessories associated with the rifle and carbine. General information is provided in the chapters of the manual, with more advanced information placed in appendix A, Ammunition, and appendix B, Ballistics.

Chapters 5 through 9 provide the employment, stability, aiming, control and movement information. This portion focuses on the Soldier skills needed to produce well aimed shots. Advanced engagement concepts are provided in appendix C of this publication. Appendix D of this publication provides common tactical drills that are used in training and combat that directly support tactical engagements. Finally, appendix E of this publication, is provided at a common location in this and future weapons publications to provide a common location for reference.

This manual does not cover the specific rifle or carbine training strategy, ammunition requirements for the training strategy, or range operations. These areas will be covered in separate training circulars.

## **Conclusion**

TC 3-22.9 applies to all Soldiers, regardless of experience or position. This publication is designed specifically for the Soldier's use on the range during training, and as a reference while deployed.

This page intentionally left blank.

## Chapter 1 Overview

This TC is designed to provide Soldiers the critical information on their rifle or carbine to properly and effectively engage and destroy threats in a direct fire engagement. It relies on the Soldier's understanding of the weapon, how it functions, its capabilities, the capabilities of the optics and ammunition, and how to properly employ those capabilities to achieve mastery through the application of the functional elements of the shot process.

This chapter describes the principles of proper weapons handling, tactical applications and control measures for handling the weapons, and an overview of the concepts of overmatch as it pertains to a Soldier's individual weapon.

1-1. Each Soldier is responsible for placing accurate and effective fires on threat targets with their individual weapon. This manual defines the functional elements of the shot process, the principles of operation of the weapon, the characteristics and description of ballistics and ammunition, and the various engagement techniques that are essential to build Soldier proficiency with their weapon. It includes standard drills and techniques that assist the Soldier to build, improve, and sustain their skills to achieve accurate and precise shots consistently during combat operations (see figure 1-1).

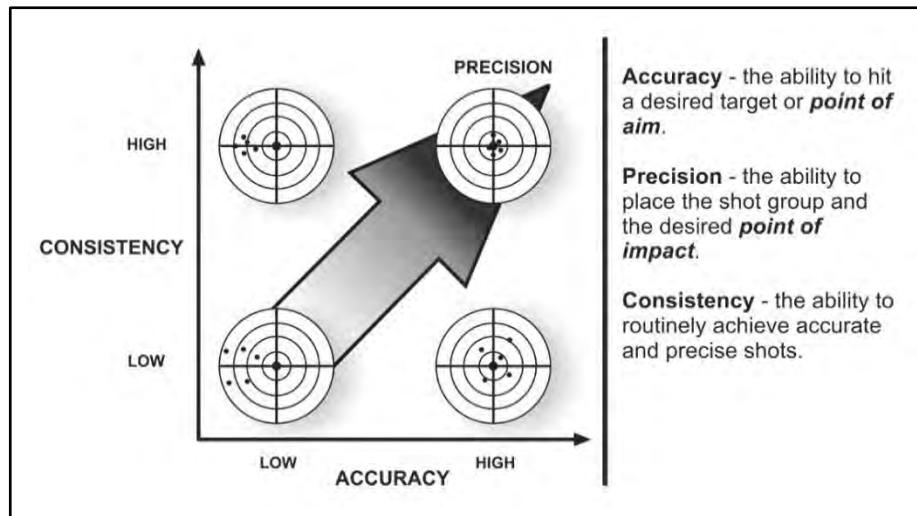

Figure 1-1. Employment skills



Chapter 1

---

## SAFE WEAPONS HANDLING

1-2. Safe weapons handling procedures are a consistent and standardized way for Soldiers to handle, operate, and employ the weapon safely and effectively. Weapons handling is built on three components; the Soldier, the weapon, and the environment:

- The **Soldier** must maintain situational understanding of friendly forces, the status of the weapon, and the ability to evaluate the environment to properly handle any weapon. The smart, adaptive, and disciplined Soldier is the primary safety mechanism for all weapons under his control.
- The **weapon** is the primary tool of the Soldier to defeat threats in combat. The Soldier must know of and how to operate the mechanical safeties built into the weapons they employ, as well as the principles of operation for those weapons.
- The **environment** is the Soldier's surroundings. The Soldier must be aware of muzzle discipline, the nature of the target, and what is behind it.

1-3. To safely and effectively handle weapons, Soldiers must be cognitively aware of three distinct weapons handling measures:

- **The rules of firearms safety.**
- **Weapons safety status.**
- **Weapons control status.**

1-4. These measures directly support the components of safe weapons handling. They are designed to provide redundant safety measures when handling any weapon or weapon system, not just rifles and carbines.

1-5. This redundancy allows for multiple fail-safe measures to provide the maximum level of safety in both training and operational environments. A Soldier would have to violate two of the rules of firearms safety or violate a weapon safety status in order to have a negligent discharge.

---

*Note.* Unit standard operating procedures (SOPs), range SOPs, or the operational environment may dictate additional safety protocols; however, the rules of firearms safety are always applied. If a unit requires Soldiers to violate these safety rules for any reason, such as for the use of blank rounds or other similar training munitions during training, the unit commander must take appropriate risk mitigation actions.

---

## RULES OF FIREARMS SAFETY

1-6. The Rules of Firearms Safety are standardized for any weapon a Soldier may employ. Soldiers must adhere to these precepts during training and combat operations, regardless of the type of ammunition employed, except as noted above.

**Rule 1: Treat Every Weapon as if it is Loaded**

1-7. Any weapon handled by a Soldier must be treated as if it is loaded and prepared to fire. Whether or not a weapon is loaded should not affect how a Soldier handles the weapon in any instance.

1-8. Soldiers must take the appropriate actions to ensure the proper weapon status is applied during operations, whether in combat or training.

**Rule 2: Never Point the Weapon at Anything You Do Not Intend to Destroy**

1-9. Soldiers must be aware of the orientation of their weapon's muzzle and what is in the path of the projectile if the weapon fires. Soldiers must ensure the path between the muzzle and target is clear of friendly forces, noncombatants, or anything the Soldier does not want to strike.

1-10. When this is unavoidable, the Soldier must minimize the amount of time the muzzle is oriented toward people or objects they do not intend to shoot, while simultaneously applying the other three rules of fire arms safety.

**Rule 3: Keep Finger Straight and Off the Trigger Until Ready to Fire**

1-11. Soldiers must not place their finger on the trigger unless they intend to fire the weapon. The Soldier is the most important safety feature on any weapon. Mechanical safety devices are not available on all types of weapons. When mechanical safeties are present, Soldiers must not solely rely upon them for safe operation knowing that mechanical measures may fail.

1-12. Whenever possible, Soldiers should move the weapon to mechanical safe when a target is not present. If the weapon does not have a traditional mechanical safe, the trigger finger acts as the primary safety.

**Rule 4: Ensure Positive Identification of the Target and its Surroundings**

1-13. The disciplined Soldier can positively identify the target and knows what is in front of and what is beyond it. The Soldier is responsible for all bullets fired from their weapon, including the projectile's final destination.

1-14. Application of this rule minimizes the possibility of fratricide, collateral damage, or damage to infrastructure or equipment. It also prepares the Soldier for any follow-on shots that may be required.

**Chapter 1**

**WEAPON SAFETY STATUS**

1-15. The readiness of a Soldier’s weapon is termed as its *weapon safety status (WSS)*.  
 △ It is a standard code that uses common colors (green, amber, red, and black) to represent the level of readiness for a given weapon.

1-16. Each color represents a specific series of actions that are applied to a weapon. They are used in training and combat to place or maintain a level of safety relevant to the current task or action of a Soldier, small unit, or group.



△ 1-17. The WSS ratings are evaluated by the level of safety measures applied to the weapon itself. Table 1-1 describes the general safe condition of the weapon for each WSS, based on the standard color scheme found in ADP 1-02.

---

*Note.* If the component, assembly, or part described is unclear, refer to the weapon’s technical manual (TM) or chapter 2 of this publication.

---

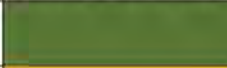
△ **Table 1-1. General safe condition of the weapon for each weapon safety status**

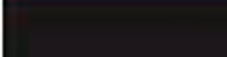
Weapon Safety Status	General Description	Color Amplifier
GREEN	Fully Safe	
AMBER	Substantially Safe	
RED	Marginally Safe	
BLACK	Not Safe	

△ 1-18. All firers and leaders must be fluent in the general meaning of each WSS, how it pertains to the weapon being employed, and the responsibilities of the firer to own each shot or burst. The following are the basic definitions for each WSS:

- Green, “Fully Safe” – the weapon is clear, no ammunition is present the chamber is empty, and the fire selector switch is set to SAFE.
- △ ● Amber, “Substantially Safe” – a leader must clear and verify that the weapon’s bolt is forward, the chamber is empty, and ammunition is introduced to the weapon. This is an administrative or preparatory WSS. Leaders use amber primarily for mounted operations and during combat operations when directed to maintain a substantially safe weapon with the ability to rapidly transition and escalate to red or black, based on the situation.

△ *Note.* WSS amber is not used in the live-fire events described in this publication.

---

**Overview**

---

- △ ● Red, “Marginally Safe” – the fire selector switch is set to SAFE, the magazine is locked in the magazine well, a round is in the chamber, and the bolt is locked in the forward position.
- △ ● Black, “Not Safe” – Indicates when the weapon is fully prepared to fire, the firer has positively identified the target, the fire selector switch is set to FIRE, and the firer’s finger is on the trigger, and the fire is in the process of engaging the target.

△ 

---

*Note.* WSS black is used to describe the actions of the firer when in a red status and entering an engagement sequence. WSS black describes the distinct difference between red and actively and deliberately engaging a threat.

---

△ 1-19. Figures 1-2 through 1-5 on pages 1-6 through 1-9 describe the standard color code for the M4-series/M16-series rifle and carbine. The Soldier performs actions described in figures 1-2 through 1-5 to move from one color code to the next.

Chapter 1

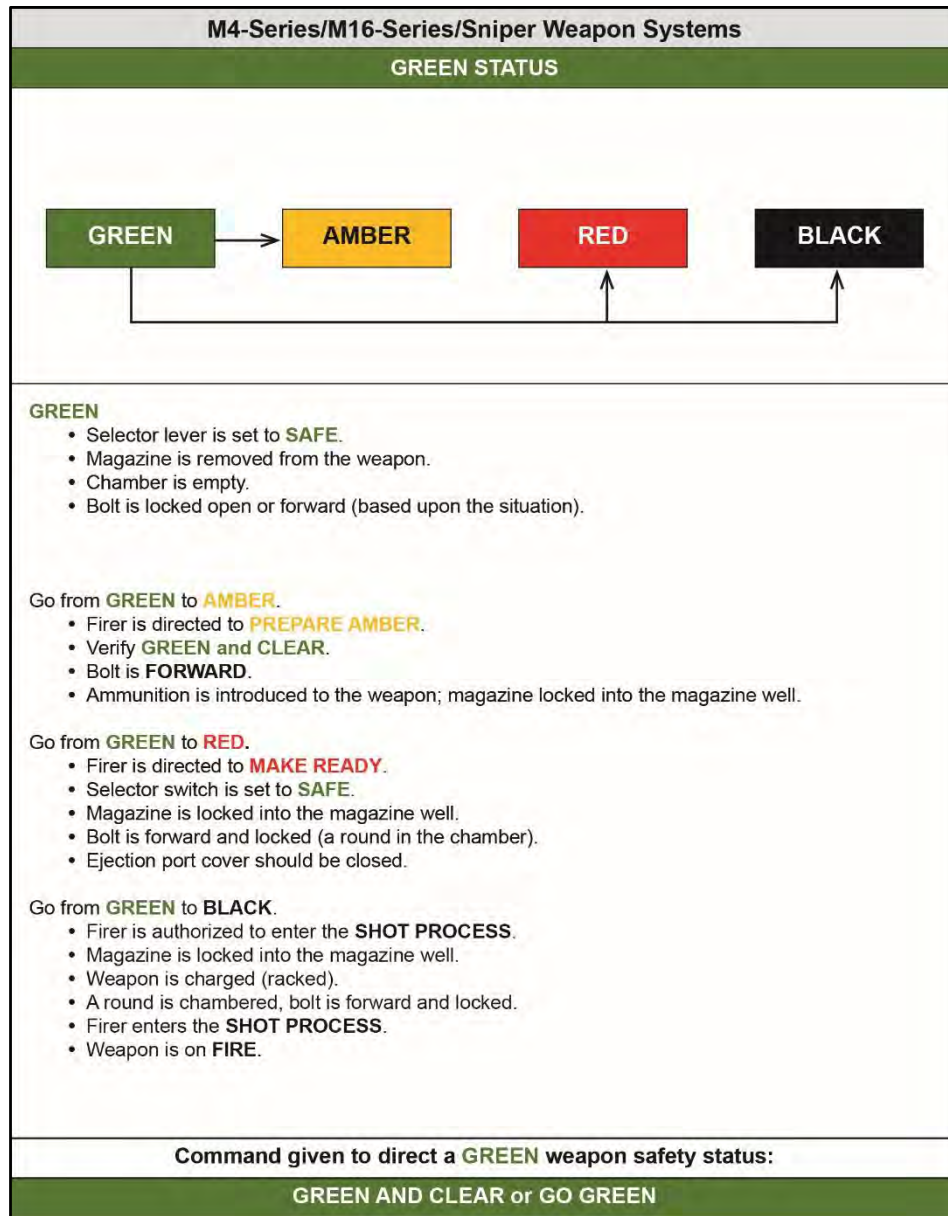

Figure 1-2. M4-/M16-series weapons, green weapon safety status

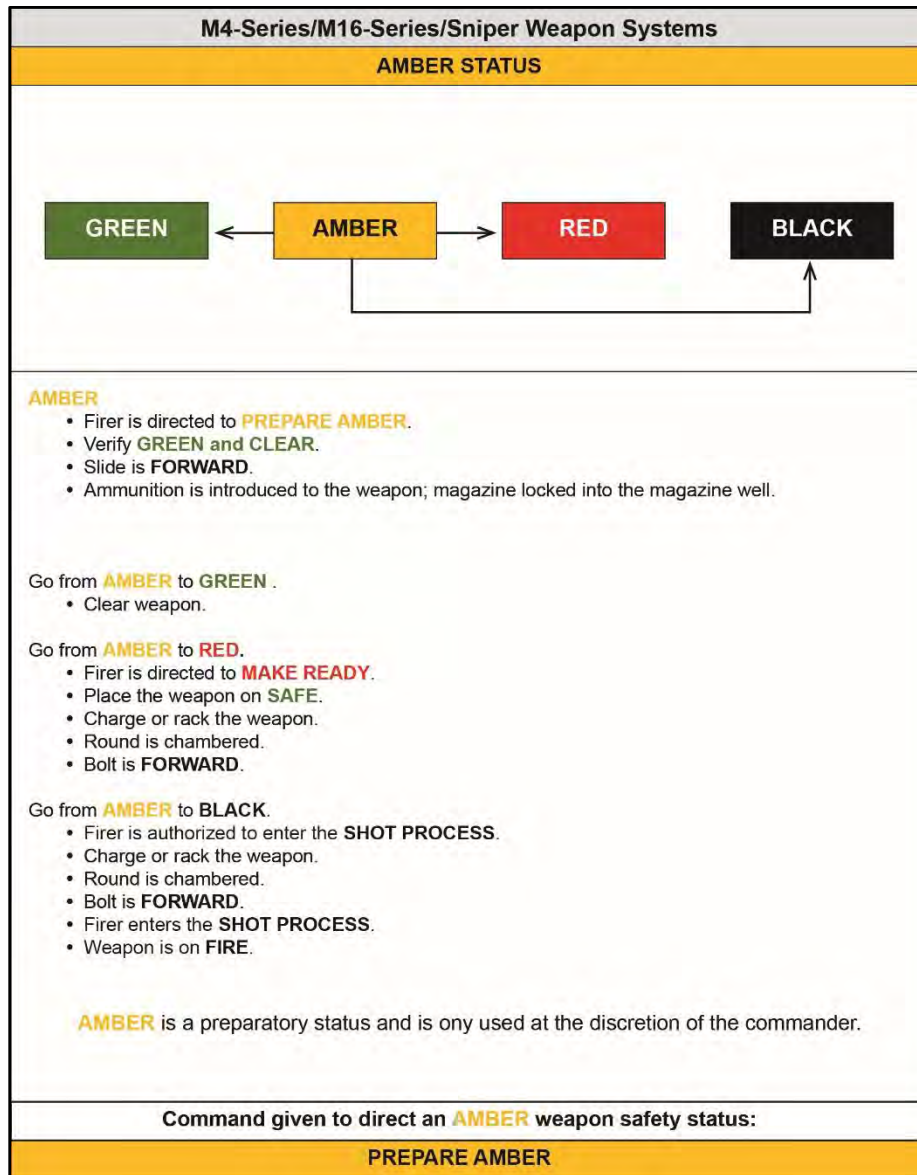

Figure 1-3. M4-/M16-series weapons, amber weapon safety status

Chapter 1

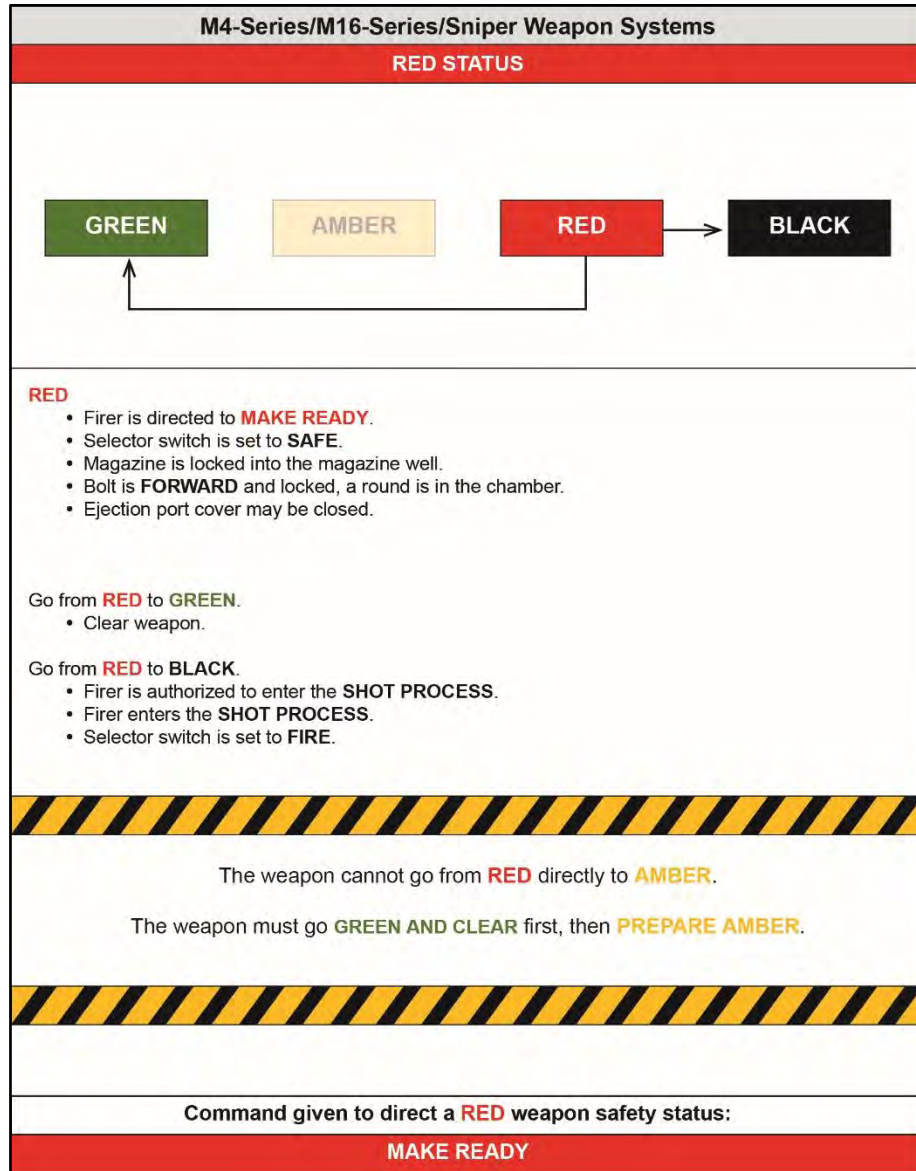

Figure 1-4. M4-/M16-series weapons, red weapon safety status

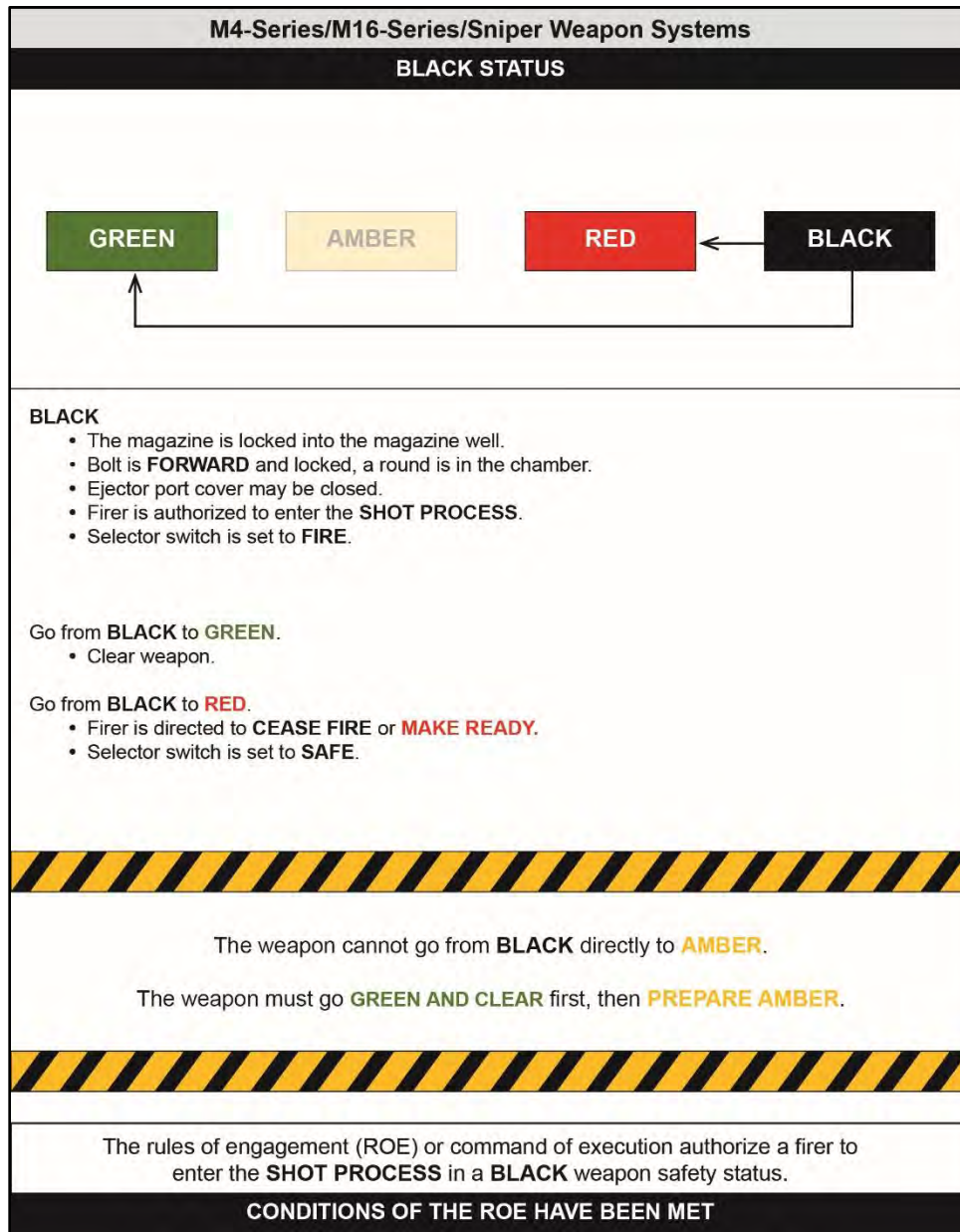

Figure 1-5. M4-/M16-series weapons, black weapons safety status





## WEAPONS CONTROL STATUS

1-20. A *weapons control status (WCS)* is a tactical method of fire control given by a leader that incorporates the tactical situation, rules of engagement for the area of operations, and expected or anticipated enemy contact. The WCS outlines the target identification conditions under which friendly elements may engage a perceived threat with direct fire.

1-21. Table 1-2 provides a description of the standard WCS used during tactical operations, both in training and combat. They describe when the firer is authorized to engage a threat target once the threat conditions have been met.

**Table 1-2. Weapons Control Status**

WEAPONS CONTROL STATUS	DESCRIPTION
WEAPONS HOLD	Engage only if engaged or ordered to engage.
WEAPONS TIGHT	Engage only if target <i>is positively identified as enemy</i> .
WEAPONS FREE	Engage targets <i>not positively identified as friendly</i> .

1-22. A weapon control status and a weapons safety status are both implemented and available to leaders to prevent fratricide and limit collateral damage. These postures or statuses are typically suited to the area of operation or type of mission and should always be clearly outlined to all Soldiers, typically in the operations order (OPORD), warning order (WARNORD), or fragmentary order (FRAGORD).

## OVERMATCH

1-23. Overmatch is the Soldier applying their learned skills, employing their equipment, leveraging technology, and applying the proper force to create an unfair fight in favor of the Soldier. To achieve and maintain overmatch against any threat, this publication focuses on providing information that develops the Soldier’s direct fire engagement skills using the following attributes:

- **Smart** – the ability to routinely generate understanding through changing conditions.
- **Fast** – the ability to physically and cognitively outmaneuver adversaries.
- **Lethal** – deadly in the application of force.
- **Precise** – consistently accurate in the application of power to ensure deliver of the right effects in time, space, and purpose.

1-24. This requires the Soldier to understand the key elements that build the unfair advantage and exploit them at every opportunity during tactical operations. The components of overmatch are:

Overview



- **Target detection, acquisition, and identification** – the ability of the Soldier to detect and positively identify any suspected target as hostile at greater distances than their adversary. This relies upon Soldier training and their ability to leverage the capabilities of their optics, thermals, and sensors.
- **Engagement range** – provide the Soldier with weapons, aiming devices, and ammunition capable of striking and defeating a threat at a greater range than the adversary can detect or engage the friendly force with effective fires.
- **Limited visibility** – provide the Soldier to make operations during limited visibility an advantage through technology and techniques, and compound their adversary’s disadvantages during those conditions.
- **Precision** – provide a weapon and ammunition package that enhances the Soldier’s consistent application of shots with a level of precision greater than the adversary’s.
- **Speed** – the weapon, aiming devices, and accessories a Soldier employs must seamlessly work in unison, be intuitive to use, and leverage natural motion and manipulations to facilitate rapid initial and subsequent shots during an engagement at close quarters, mid-, and extended ranges.
- **Terminal performance** – ensures that precise shots delivered at extended ranges provide the highest probability to defeat the threat through exceptional ballistic performance.

1-25. Although not a component of overmatch, exceptional training is critical to create smart, fast, lethal, and precise Soldiers. Training builds proficiency in a progressive, logical, and structured manner and provides Soldiers the skills necessary to achieve overmatch against any adversary. This requires the training program to provide experience to the Soldier in all the components of overmatch to their fullest extent possible in the shortest amount of time.

### TARGET DETECTION, ACQUISITION, AND IDENTIFICATION

1-26. The first component of overmatch at the Soldier level is the ability to detect targets as far away as possible during limited and low visibility conditions. This manual describes the aiming devices for the service rifle that enhance the Soldier’s target detection and acquisition skills. The Soldier must be able to detect, acquire, and identify targets *at ranges beyond* the maximum effective range of their weapon and ammunition.

1-27. This publication also provides key recognition information to build the Soldier’s skills in correctly identifying potential targets as friend, foe, or noncombatant (neutral) once detected.

### ENGAGEMENT RANGE

1-28. To ensure small unit success, the Soldier requires weapon systems that can effectively engage threats at ranges greater than those of their adversaries. This creates a standoff distance advantage that allows friendly forces to destroy the target outside the threat’s maximum effective range.

**Chapter 1**

1-29. Range overmatch provides a tactical engagement buffer that accommodates the Soldier's time to engage with precision fires. For example, a Soldier that has the capability to effectively engage personnel targets at a range of 500 meters will have range overmatch of 10 to 20 percent over a threat rifleman. That 10 to 20 percent range difference is equivalent to a distance of 40 to 80 meters, which is approximately the distance a maneuvering threat can traverse in 15 to 40 seconds.

△ 1-30. Figure 1-6 portrays the battlefield from the Soldier's perspective. With mobile, maneuvering threats, the target acquisition capabilities must compliment the engagement of those threats at the maximum effective range of the weapon, optic, and ammunition.

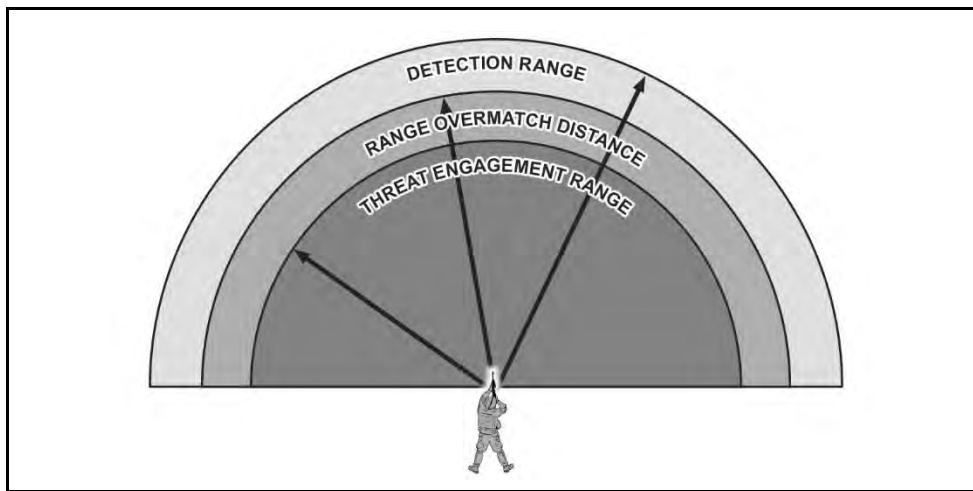

△ **Figure 1-6. Small unit range overmatch**

**LIMITED VISIBILITY**

1-31. Soldiers must be able to detect, acquire, identify, and engage threats in all light conditions, regardless of the tactical situation. To provide that capability, aiming devices are provided that minimize the effects of limited visibility, but not completely.

1-32. Image intensifiers and thermal optics provide a significant overmatch capability, but they also have limitations and disadvantages. A general discussion of their capabilities, particularly what those systems can view within the spectrum of light is provided. Soldiers must understand what can be "seen" or viewed and what cannot when using their assigned equipment. Understanding the advantages and limitations of their equipment has a direct impact on force protection, fratricide and collateral damage prevention, and maintaining overmatch during tactical operations.

**PRECISION**

1-33. The Army standard service rifle is designed with a specific level of accuracy out to its maximum effective range. This level of accuracy is more consistent and reliable

**Overview**

---

through the use of magnified aiming devices and superior ammunition. The Soldier must build the skills to use them effectively to deliver precision fires during tactical engagements.

**SPEED**

1-34. The close fight requires rapid manipulations, a balance of speed and accuracy, and very little environmental concerns. Soldiers must move quickly and efficiently through their manipulations of the fire control to maintain the maximum amount of muzzle orientation on the threat through the shot process. This second-nature efficiency of movement only comes from regular practice, drills, and repetition.

1-35. The foundation of speed of action is built through understanding the weapon, ammunition, ballistics, and principles of operation of the associated aiming devices. It is reinforced during drills (appendix D), and the training program of the unit.

1-36. The goal of training to overmatch is to increase the speed at which the Soldier detects a threat, identifies it as hostile, and executes the shot process with the desired target effect. This manual is constructed to provide the requisite information in a progressive manner to build and reinforce Soldier understanding, confidence, and ability to execute tactical operations with speed and smooth fluidity of motion.

**TERMINAL BALLISTIC PERFORMANCE**

1-37. Terminal ballistic performance is the actions of a projectile from the time it strikes an object downrange until it comes to rest. The ammunition used with the service rifle performs exceptionally well out to its maximum effective range and beyond. This manual provides information on the various munition types available for training and combat, their capabilities and purpose, and the service (combat) round's terminal ballistic performance (see appendix A, Ammunition, and appendix B, Ballistics).

1-38. Soldiers must understand the capabilities of their ammunition, whether designed for training or combat use. That understanding creates a respect for the weapon and ammunition, reinforces the precepts of safe weapons handling, and an understanding of the appropriate skills necessary to deliver lethal fires.

1-39. Soldiers that understand the "how" and "why" of their weapon system, aiming devices, ammunition, and procedures work or function develops a more comprehensive understanding. That level of understanding, coupled with a rigorous training program that builds and strengthens their skills create more proficient Soldiers. The proficiencies and skills displayed during training translate into smart, fast, lethal and precise Soldiers for the small unit during decisive action combat operations.

This page intentionally left blank.

## Chapter 2

# Rifle and Carbine Principles of Operation

This chapter provides the general characteristics, description, available components, and principles of operation for the M4- and M16-series weapons. It provides a general overview of the mechanics and theory of how weapons operate, key terms and definitions related to their functioning, and the physical relationship between the Soldier, the weapon, and the optics/equipment attached to the weapon.

## ARMY STANDARD SERVICE RIFLE

2-1. The Army standard service rifle is either the M16-series rifle or M4-series carbine. These weapons are described as a lightweight, 5.56-mm, magazine-fed, gas-operated, air-cooled, shoulder-fired rifle or carbine. They fire in semiautomatic (single-shot), three-round burst, or in automatic mode using a selector lever, depending on the variant. The weapon system has a standardized mounting surface for various optics, pointers, illuminators, and equipment, to secure those items with common mounting and adjustment hardware.

2-2. Each service rifle weapon system consists of components, assemblies, subassemblies, and individual parts. Soldiers must be familiar with these items and how they interact during operation.

- **Components** are uniquely identifiable group of fitted parts, pieces, assemblies or subassemblies that are required and necessary to perform a distinctive function in the operation of the weapon. Components are usually removable in one piece and are considered indivisible for a particular purpose or use.
- **Assemblies** are a group of subassemblies and parts that are fitted to perform specific set of functions during operation, and cannot be used independently for any other purpose.
- **Subassemblies** are a group of parts that are fitted to perform a specific set of functions during operation. Subassemblies are compartmentalized to complete a single specific task. They may be grouped with other assemblies, subassemblies and parts to create a component.
- **Parts** are the individual items that perform a function when attached to a subassembly, assembly, or component that serves a specific purpose.

2-3. Each weapon consists of two major components: the upper receiver and the lower receiver. These components are described below including their associated assemblies, subassemblies, and parts.

## Chapter 2

### UPPER RECEIVER

2-4. An aluminum receiver helps reduce the overall weight of the rifle/carbine and allows for mounting of equipment and accessories. The upper receiver consists of the following (see figure 2-1):

- Barrel assembly.
  - **Barrel.** The bore and chamber of the barrel are chrome-plated to reduce wear and fouling over the life of the weapon.
  - **Flash hider or compensator.** Located at the end of the barrel, is provided to reduce the signature of the weapon during firing and reduce barrel movement off target during firing.
  - **Sling swivel.** The attachment hardware for the sling system used to properly carry the weapon.
  - **Front sight assembly.** Includes an adjustable front sight post that facilitates zeroing the weapon, serves as the forward portion of the iron sight or back up iron sight, and assists with range determination.
  - **Adapter rail system (ARS).** Provided in varying lengths, depending on the variant applied. Used to attach common aiming devices or accessories.
  - **Slip ring.** Provides a spring loaded locking mechanism for the weapon's hand guards.
  - **Ejection port.** Provides an opening in the upper receiver to allow ammunition or spent casing ejection from the weapon.
  - **Ejection port cover.** Provides a dust cover for the ejection port, protecting the upper receiver and bolt assembly from foreign objects.
  - **Forward assist assembly.** Provides a Soldier applied mechanical assist to the bolt assembly during operations.

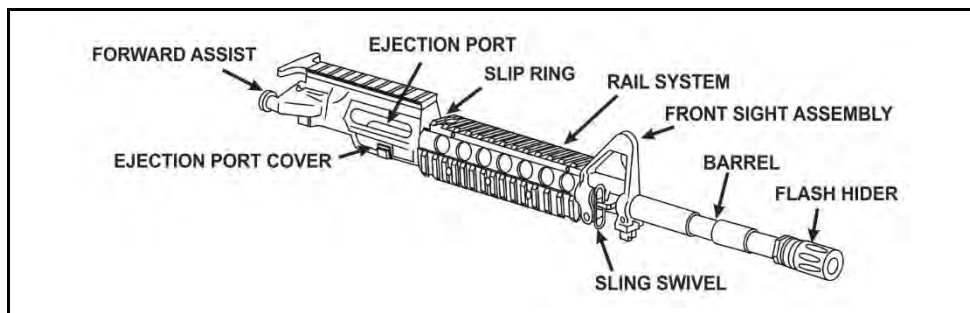

Figure 2-1. Upper receiver

**Rifle and Carbine Principles of Operation**

**LOWER RECEIVER**

2-5. The lower receiver shown in figure 2-2, on page 2-3, consists of the following components, assemblies, and parts:

- **Trigger assembly.** Provides the trigger, pins, springs, and other mechanical components necessary to fire the weapon.
- **Bolt catch.** A mechanical lever that can be applied to lock the bolt to the rear by the Soldier, or automatically during the cycle of function when the magazine is empty (see page 2-4).
- **Rifle grip.** An ambidextrous pistol-type handle that assists in recoil absorption during firing.
- **Magazine catch assembly.** Provides a simple, spring-loaded locking mechanism to secure the magazine within the magazine well. Provides the operator an easy to manipulate, push-to-release textured button to release the magazine from the magazine well during operation.
- **Buttstock assembly.** Contains the components necessary for proper shoulder placement of the weapon during all firing positions, returning the bolt assembly to battery, and managing the forces of recoil during operation.
  - The M4-/M4A1-series carbine has a four position collapsible buttstock assembly: Closed, 1/2 open, 3/4 open, and fully-open.
  - M16-series rifles have a fixed buttstock with cleaning kit compartment or an applied modified work order (MWO) collapsible buttstock.
- **Action spring.** Provides the stored energy to return the bolt carrier assembly back into battery during operation.
- **Lower receiver extension.** Provides space for the action spring and buffer assembly during operation.

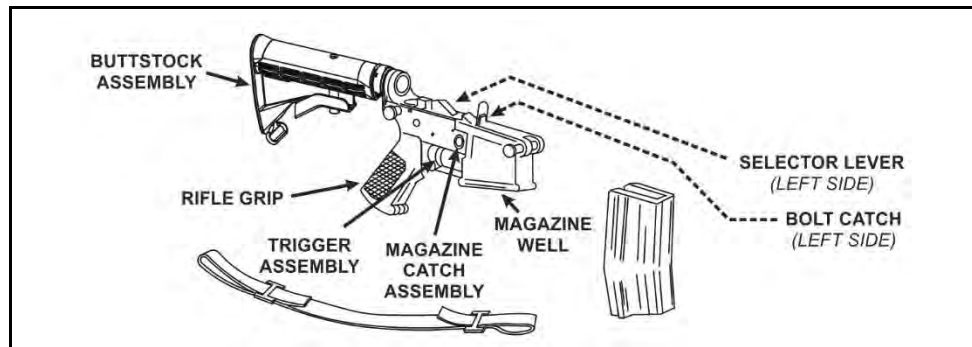

**Figure 2-2. Lower receiver**

2-6. Additional information on the characteristics and components of the M4-/M4A1-/M16-series weapons can be found in technical manual (TM) 9-1005-319-10. Soldiers will use the technical manual for preventative maintenance checks and services (PMCS),



**Chapter 2**

and operation under normal conditions, as well as more detailed information on the principles of operation.

2-7. Each variant of the rifle and carbine have subtle capabilities differences. The primary differences are shown in table 2-1, and are specific to the weapon’s selector switch, buttstock, and barrel length.

**Table 2-1. Model Version Firing Methods Comparison**

<i>Weapon</i>	<i>Selector Switch Position</i>			<i>Buttstock</i>	<i>Barrel Length</i>
M16A2	SAFE	SEMI	BURST	Full	20 inches
M16A3	SAFE	SEMI	AUTO	Full	20 inches
M16A4	SAFE	SEMI	BURST	Full	20 inches
M4	SAFE	SEMI	BURST	Collapsible	14.5 inches
M4A1	SAFE	SEMI	AUTO	Collapsible	14.5 inches
<b>Legend:</b> SEMI: semi-automatic firing selection AUTO: fully automatic firing selection BURST: three-round burst firing selection					

**CYCLE OF FUNCTION**

2-8. The *cycle of function* is the mechanical process a weapon follows during operation. The information provided below is specific to the cycle of function as it pertains specifically to the M4- and M16-series weapons.

2-9. The cycle starts when the rifle is ready with the bolt locked to the rear, the chamber is clear, and a magazine inserted into the magazine well with at least one cartridge. From this state, the cycle executes the sequential phases of the cycle of functioning to fire a round and prepare the weapon for the next round. The phases of the cycle of function in order are—

- Feeding.
- Chambering.
- Locking.
- Firing.
- Unlocking.
- Extracting.
- Ejecting.
- Cocking.

2-10. For the weapon to operate correctly, semiautomatic and automatic weapons require a *system of operation* to complete the cycle of functioning. The M4- and M16-series weapons use a direct impingement gas operating system. This system uses a portion of the high pressure gas from the cartridge being fired to physically move the assemblies and subassemblies in order to complete the cycle of function.

**Rifle and Carbine Principles of Operation**

**FEEDING**

2-11. Feeding is the process of mechanically providing a cartridge of ammunition to the entrance of the chamber (see figure 2-3).

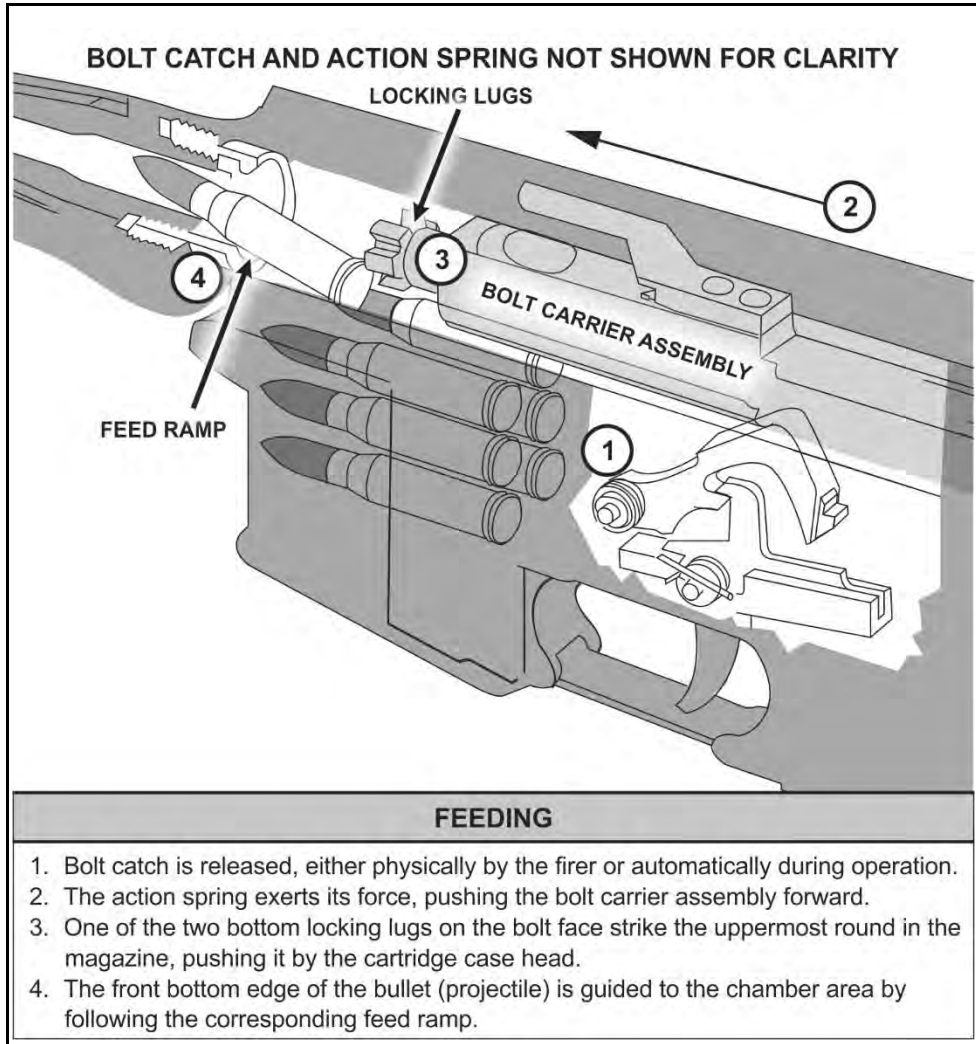
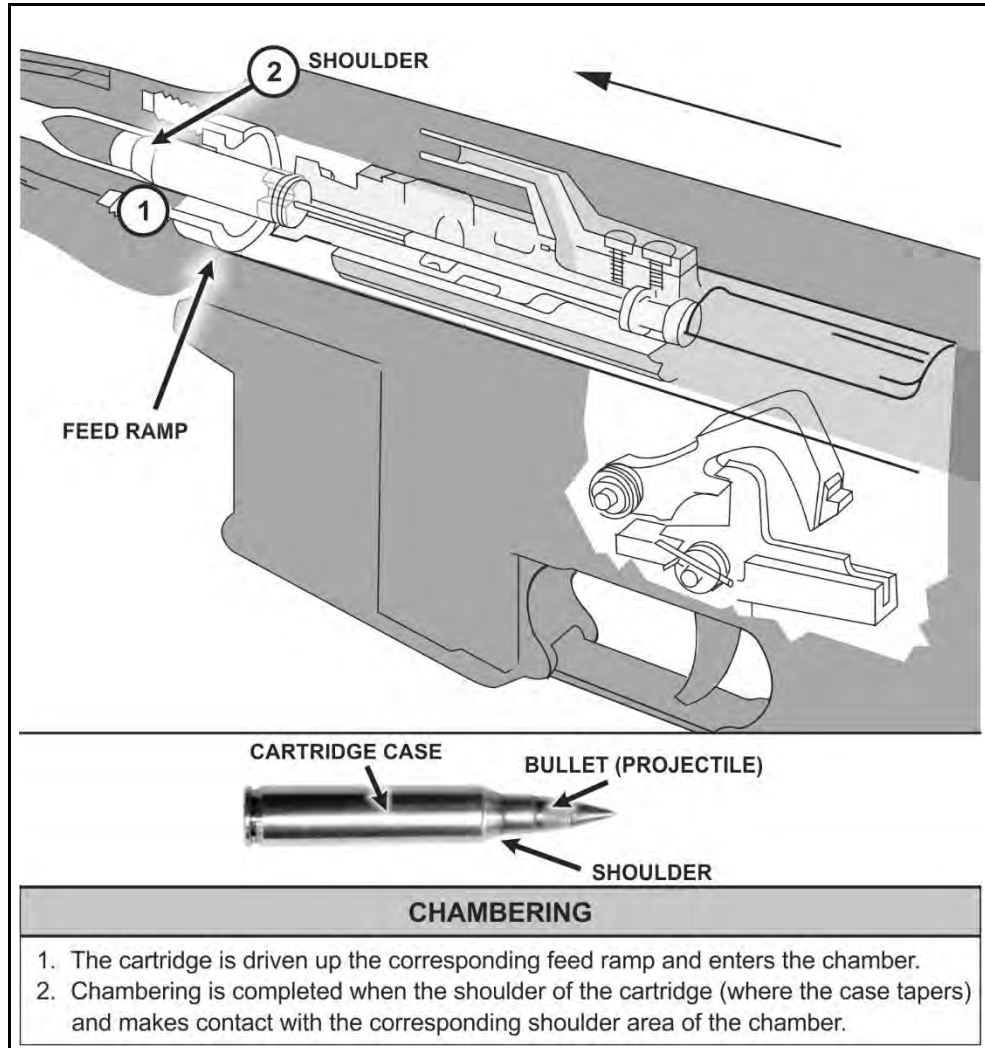

**Figure 2-3. Feeding example**

**Chapter 2**

**CHAMBERING**

2-12. Chambering is the continuing action of the feeding round into the chamber of the weapon (see figure 2-4).



**Figure 2-4. Chambering example**

Rifle and Carbine Principles of Operation

**LOCKING**

2-13. Locking is the process of creating a mechanical grip between the bolt assembly and chamber with the appropriate amount of headspace (clearance) for safe firing (see figure 2-5). With the M4- and M16-series weapons, locking takes place simultaneously with the final actions of chambering.

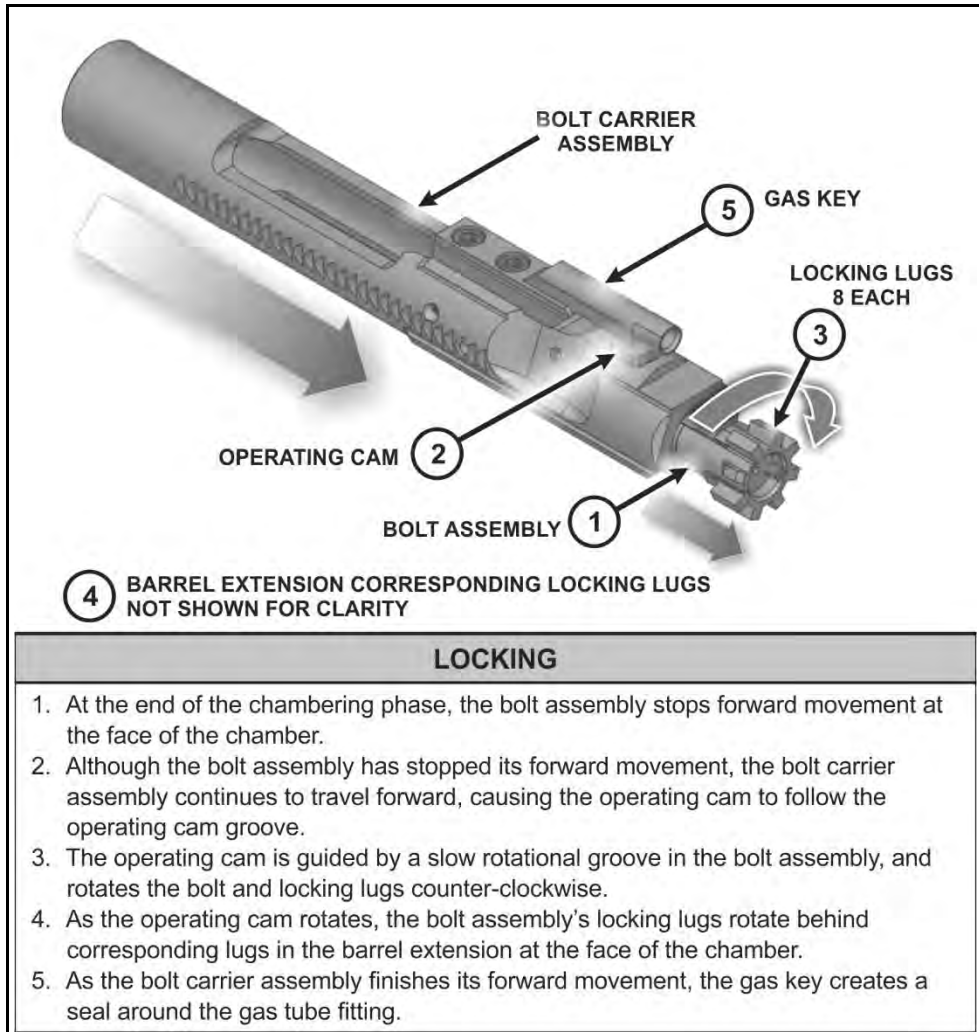

Figure 2-5. Locking example

## Chapter 2

### FIRING

2-14. Firing is the finite process of initiating the primer detonation of the cartridge and continues through shot-exit of the projectile from the muzzle (see figure 2-6).

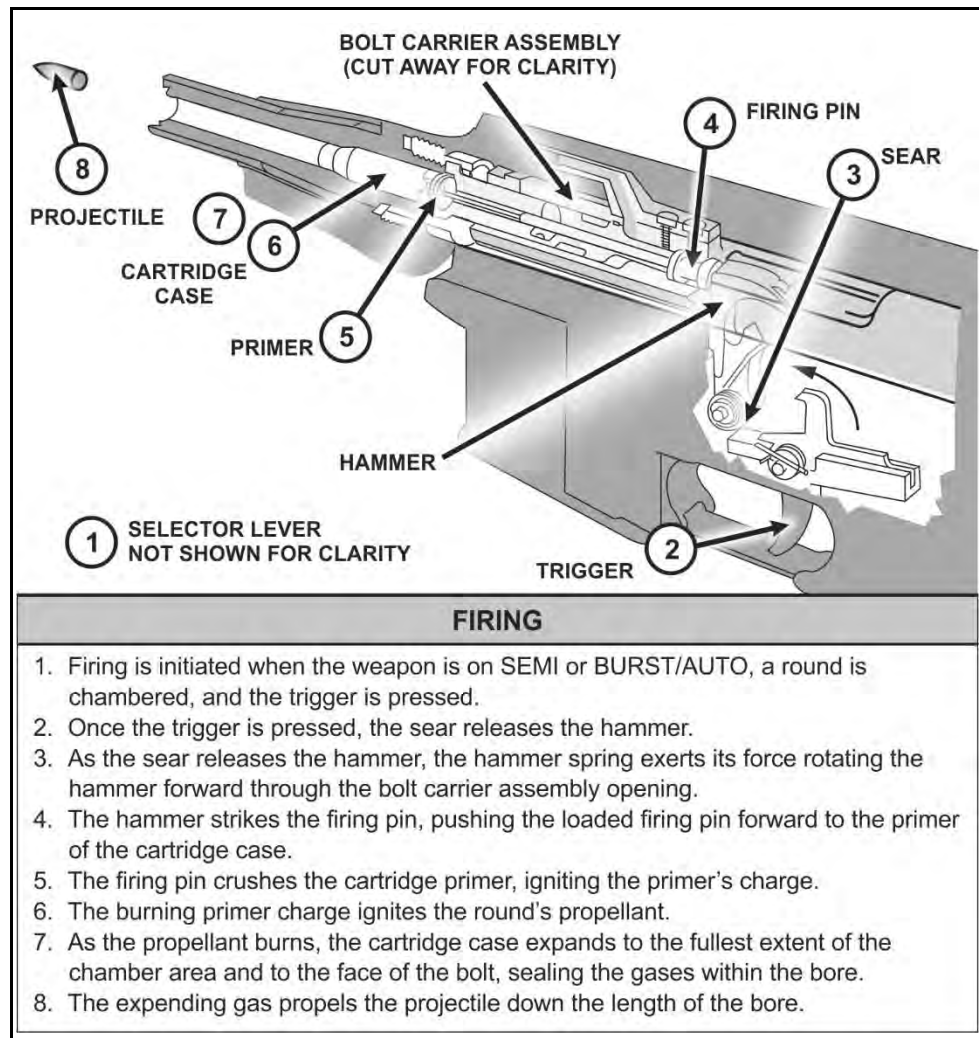
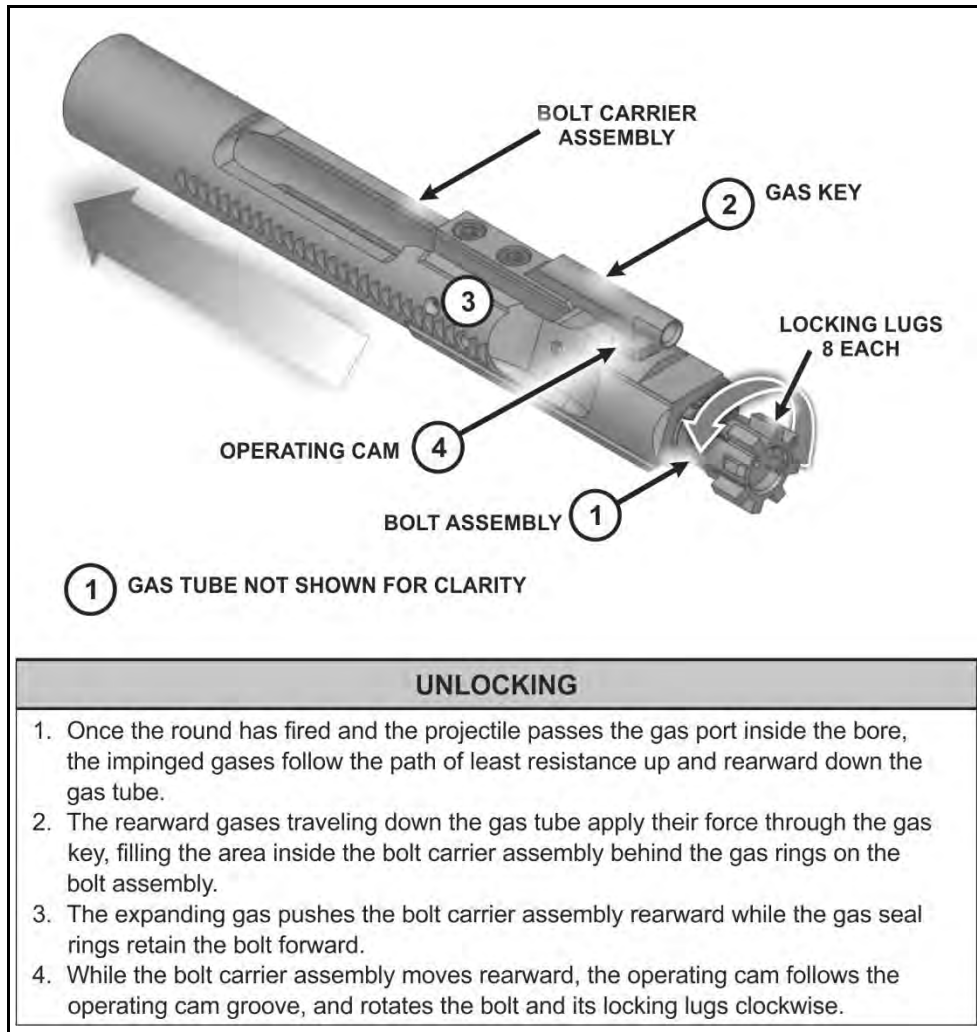

Figure 2-6. Firing example

**Rifle and Carbine Principles of Operation**

**UNLOCKING**

2-15. Unlocking is the process of releasing the locking lugs on the bolt face from the corresponding recesses on the barrel extension surrounding the chamber area (see figure 2-7).

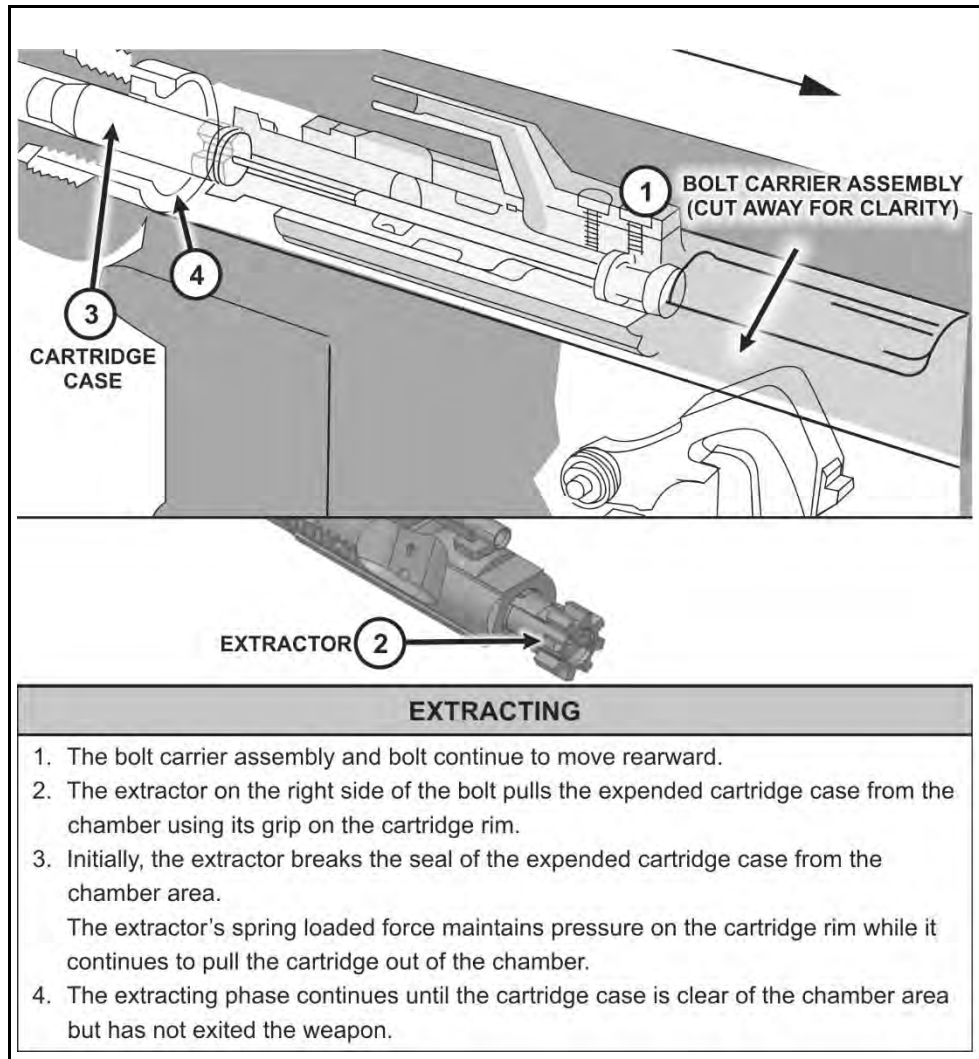

**Figure 2-7. Unlocking example**

**Chapter 2**

**EXTRACTING**

2-16. Extracting is the removal of the expended cartridge case from the chamber by means of the extractor (see figure 2-8).

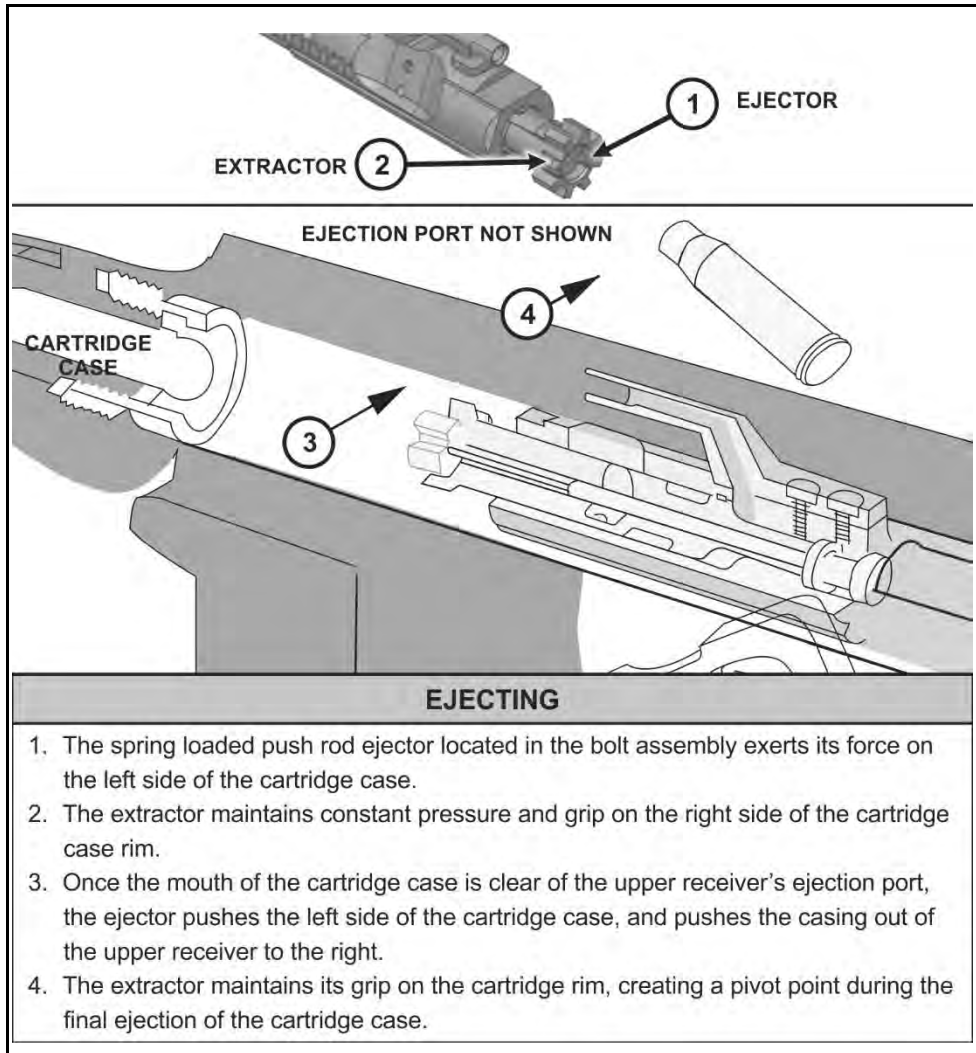

**Figure 2-8. Extraction example**

**Rifle and Carbine Principles of Operation**

**EJECTING**

2-17. Ejecting is the removal of the spent cartridge case from the weapon itself (see figure 2-9.)



**Figure 2-9. Ejection example**



**Chapter 2**

**COCKING**

2-18. Cocking is the process of mechanically positioning the trigger assembly's parts for firing (see figure 2-10). The cocking phase completes the full cycle of functioning.

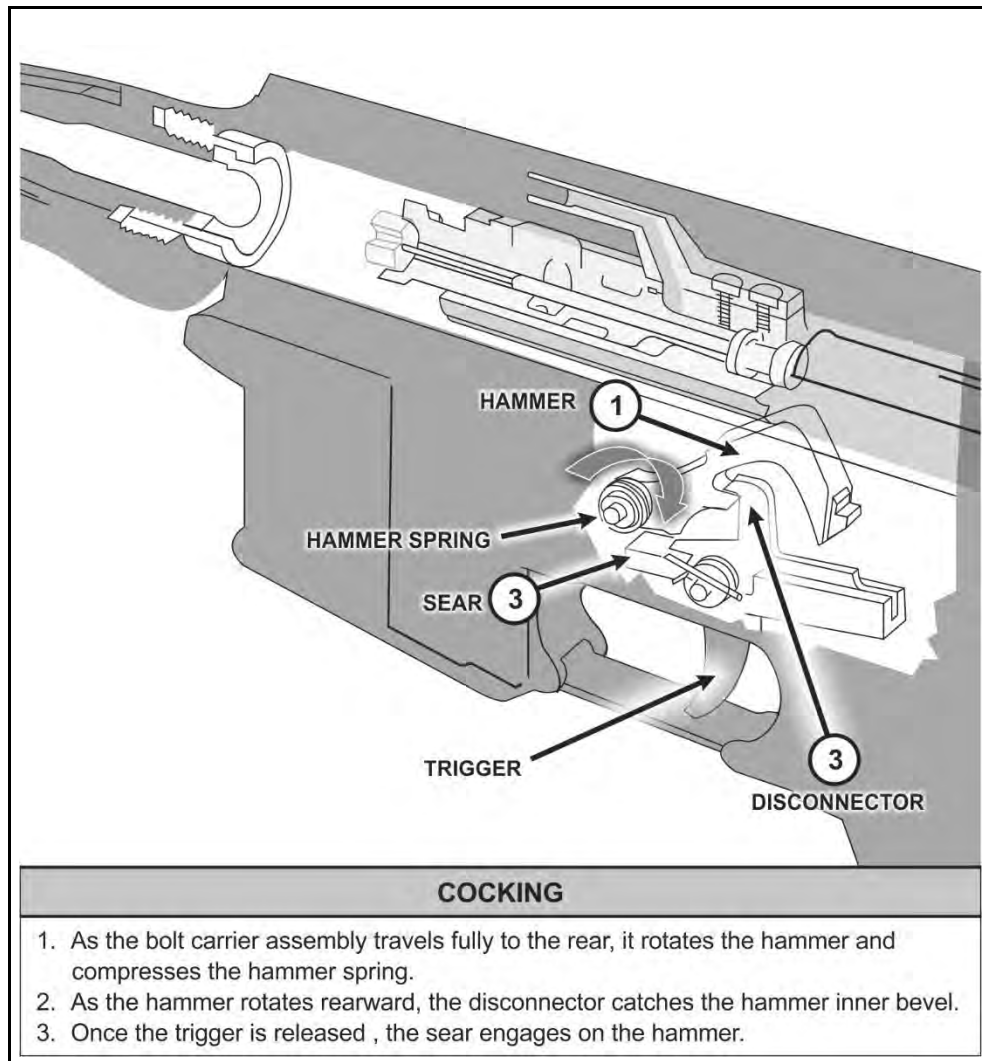

**Figure 2-10. Cocking example**

---

**Rifle and Carbine Principles of Operation**

---

## **COOLING**

2-19. Cooling is the process of dissipating heat from the weapon during firing. Although not part of the cycle of functioning, cooling the weapon during firing is critical to ensure the weapon continues to operate efficiently. Firing a round generates heat and pressure within the chamber and bore, which radiates outward through the metal of the barrel.

2-20. The temperature generated by the burning of propellant powders is over one thousand degrees Fahrenheit. Some of the heat produced during firing is retained in the chamber, bore, and barrel during firing and poses a significant hazard to the firer.

2-21. How this heat is absorbed by the weapon and dissipated or removed, is a function of engineering and design. Lightweight weapons like the M4 and M16 do not have sufficient mass to withstand thermal stress efficiently. The weapon system must have a means to radiate the heat outward, away from the barrel to allow continuous firing.

2-22. There are three methods to reduce the thermal stress on a weapon. The M4- and M16-series of weapons use all three of these methods to varying degrees to cool the chamber, bore, and barrel to facilitate continuous operation. These methods of cooling are—

- **Radiational cooling** – allows for the dissipation of heat into the surrounding cooler air. This is the least efficient means of cooling, but is common to most small arms weapons, including the rifle and carbine.
- **Conduction cooling** – occurs when a heated object is in direct physical contact with a cooler object. Conduction cooling on a weapon usually results from high chamber operating temperatures being transferred into surrounding surfaces such as the barrel and receiver of the weapon. The transfer from the chamber to the cooler metals has the net effect of cooling the chamber. Thermal energy is then carried away by other means, such as radiant cooling, from these newly heated surfaces.
- **Convection cooling** – requires the presence of a moving air current. The moving air has greater potential to carry away heat. The hand guards and ARS of the rifle and carbine are designed to facilitate air movement. The heat shield reflects heat energy away from the hand guard and back towards the barrel. The net effect is an updraft that brings the cooler air in from the bottom. This process establishes a convection cycle as heated air is continually replaced by cooler air.

2-23. Soldiers should be aware of the principles of the weapon's cooling methods' direct effects on their line of sight when viewing a target through an aiming device. Dissipating heat along the length of the barrel can create a mirage effect within the line of sight which can cause a significant error to the true point of aim when using magnified optics.

This page intentionally left blank.

## Chapter 3

# Aiming Devices

Every weapon has a method of aiming, that is either fixed or attached to operate the weapon effectively. Soldiers must be familiar with the various aiming devices, how they operate, and how to employ them correctly to maximize their effectiveness. This chapter provides the principles of operation of the most widely available aiming devices, and provides general information concerning their capabilities, function and use.

3-1. An aiming device is used to align the Soldier, the weapon, and the target to make an accurate and precise shot. Each aiming device functions in a different manner. To employ the weapon system to its fullest capability, the Soldier must understand how their aiming devices function.

3-2. The following aiming devices are described within this chapter:

- **Iron.** Iron represent the various types of mechanical sighting systems available on the weapon. They are available in two distinct types:
  - Iron sights (rear aperture and front sight post).
  - Back up iron sights (BUIS).
- **Optics.** These are optics predominantly for day firing, with limited night capability. The optics found within this manual come in two types:
  - Close Combat Optic (CCO).
  - Rifle Combat Optic (RCO, previously referred to as the Advanced Combat Optic Gunsight or ACOG).
- **Thermal.** These are electronic sighting systems that provide a view of the field of view (FOV) based on temperature variations. There are numerous variants of thermal optics, but are grouped into one type:
  - Thermal Weapon Sight (TWS).
- **Pointer/Illuminator/Laser.** These aiming devices use either a laser beam, flood light, or other light to aim the weapon at the target. There are three types of pointers, illuminators, and lasers used by the service rifle:
  - Advanced Target Pointer Illuminator Aiming Light (ATPIAL).
  - Dual Beam Aiming Laser–Advanced (DBAL-A2).
  - Illuminator, Integrated, Small Arms (STORM).

**Chapter 3**

**UNITS OF ANGULAR MEASUREMENT**

3-3. There are two major units of angular measurement the Army uses: mils and minutes of angle (MOA). These two different units are commonly used terms to describe a measurement of accuracy when firing a weapon, system, or munition. They typically include the accuracy of a specific weapon, the performance of ammunition, and the ability of a shooter as it relates to firing the weapon.

**MINUTE OF ANGLE**

3-4. A minute of angle (MOA) is an angular unit of measurement equal to 1/60<sup>th</sup> of a degree (see figure 3-1). The most common use of MOA is when describing the distance of change required when zeroing a weapon.

3-5. One MOA equals 1.047 inches per 100 yards. For most applications, a Soldier can round this to 1 inch at 100 yards or 1.1 inches at 100 meters to simplify their arithmetic.

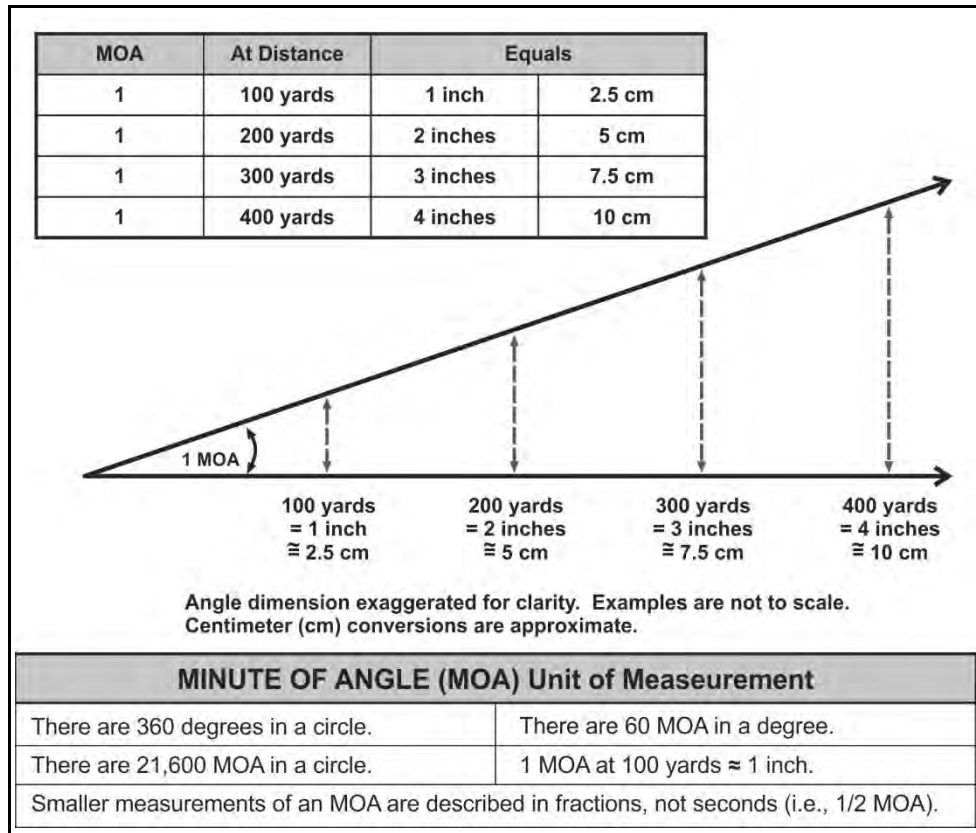
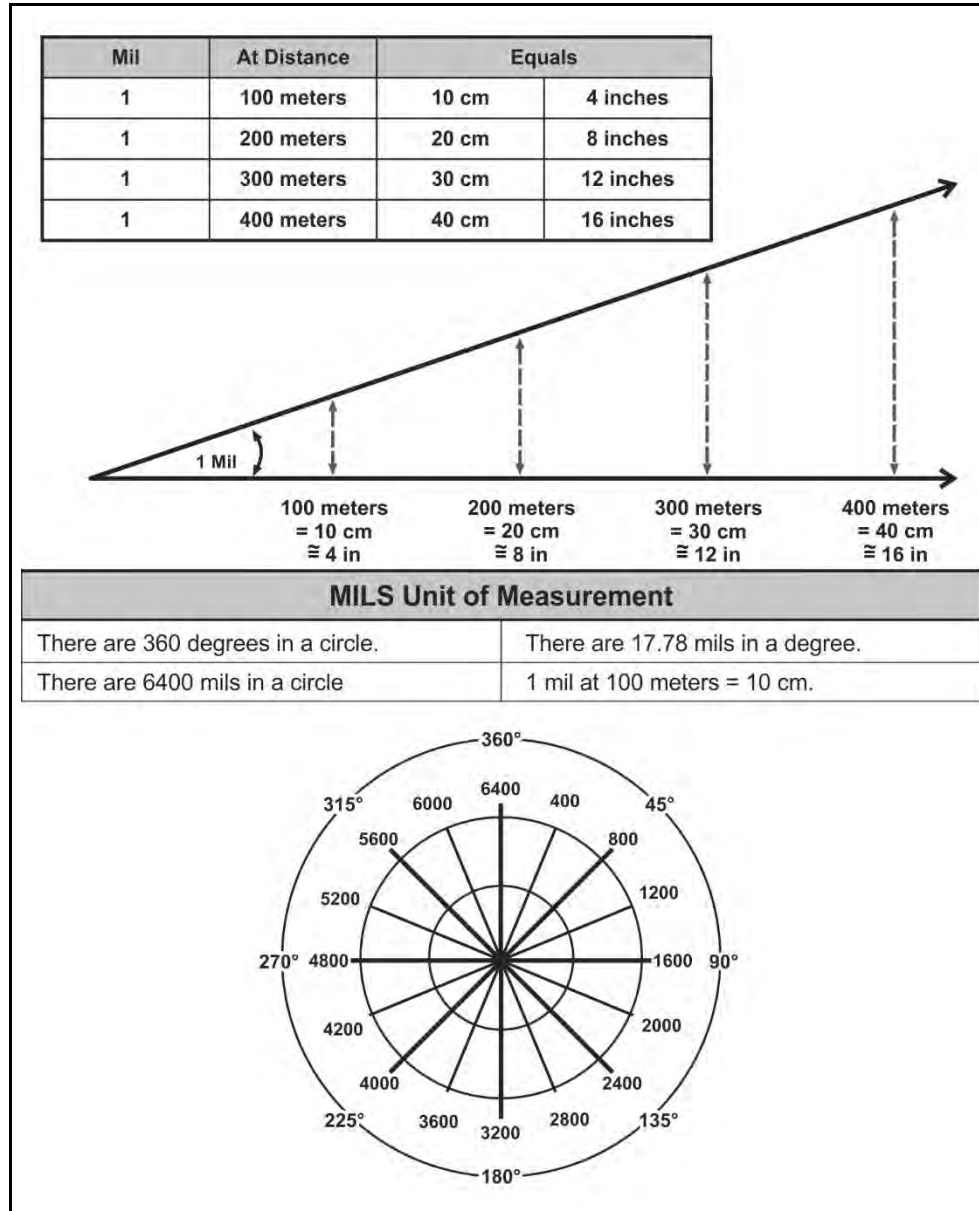

**Figure 3-1. Minute of angle example**

**Aiming Devices**

**MILS**

3-6. The mil is a common unit of angular measurement that is used in direct fire and indirect fire applications. (see figure 3-2)



**Figure 3-2. Mil example**

**Chapter 3**

---

3-7. This mil to degree relationship is used when describing military reticles, ballistic relationships, aiming devices, and on a larger scale, map reading and for indirect fire.

**RETICLE**

3-8. A reticle is a series of fine lines in the eyepiece of an optic, such as a CCO, TWS, or RCO (see figure 3-3) used as a measuring scale with included aiming or alignment points. Reticles use either mils or minute of angle for their unit of measurement.

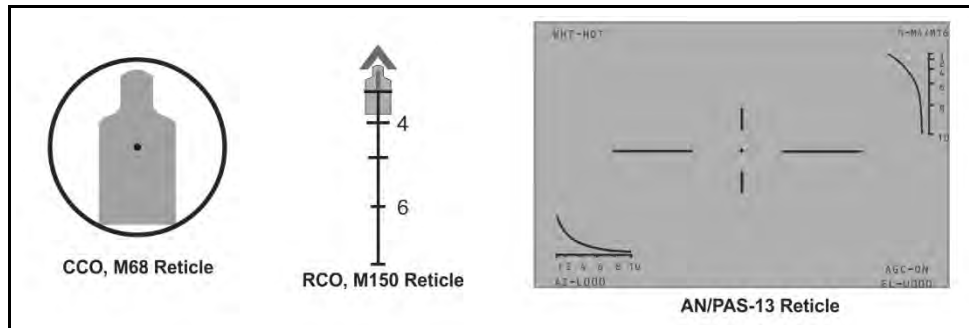
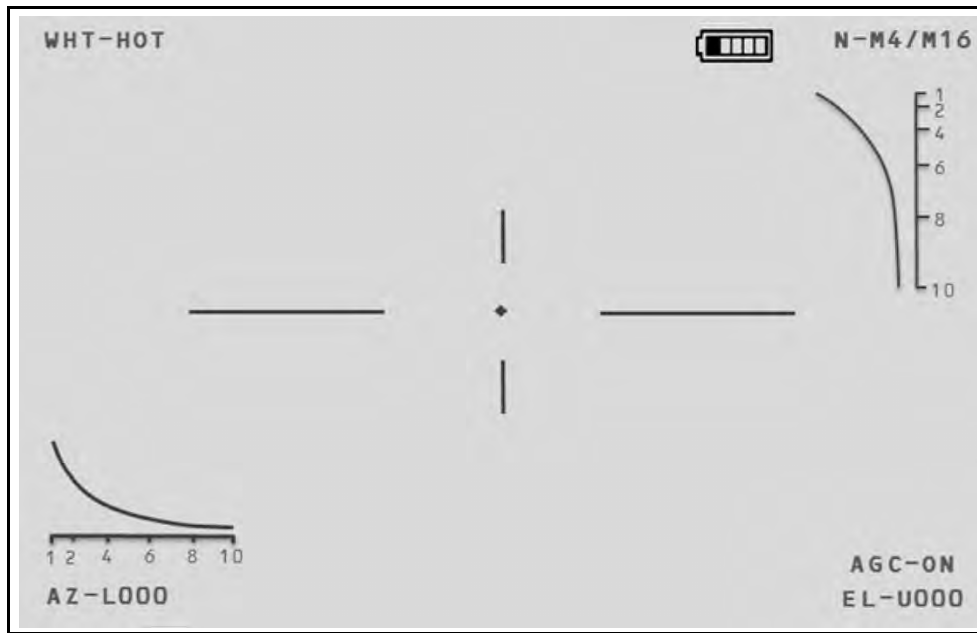

**Figure 3-3. Close combat optic / Rifle combat optic reticle / Thermal reticle examples**

**Aiming Devices**

**STADIA RETICLE (STADIAMETRIC RETICLE)**

3-9. Commonly used in the thermal weapon sight, a stadia reticle provides a means of rapidly determining the approximate range to target of a viewed threat, based on its standard dimensions. The stadia reticle (sometimes referred to as “stadia metric” or “choke sight”) can provide approximate range to target information using width or height of a viewed dismounted target using standard threat dimensions (see figure 3-4).



**Figure 3-4. Stadia reticle example**

3-10. There are two stadia reticles found on the rifle / carbine reticle within the thermal weapons sight; vertical and horizontal.

- **Vertical stadia.** At the lower left of the sight picture, Soldiers can evaluate the range to target of a standing dismounted threat.
- **Horizontal stadia.** In the upper right portion of the sight picture, Soldiers can evaluate the range to target of an exposed dismounted threat based on the width of the target.



## Chapter 3

---

### ELECTROMAGNETIC SPECTRUM

3-11. A major concern for the planning and use of thermal and other optics to aid in the detection process is understanding *how they function*, but more appropriately, what they can “see”. Each device develops a digital representation of the scene or view it is observing based on what frequencies or wavelengths it can detect within the electromagnetic spectrum. (Note: Thermal devices see differences in heat.)

- **Thermal optics.** This equipment operates in the mid- and far-wavelength of the infrared band, which is the farthest of the infrared wavelengths from visible light. Thermal optics cannot translate (“see”) visible light. Thermal optics cannot “see” infrared equipment such as infrared (IR) strobe lights, IR chemical lights, illuminators, or laser pointers. They can only identify emitted radiation in the form of heat (see figure 3-5 on page 3-7).
- **Image intensifiers (I2).** This equipment, such as night vision devices, use the near area of the infrared spectrum closest to the frequencies of visible light, as well as visible light to create a digital picture of the scene. These systems cannot “see” or detect heat or heat sources.

3-12. These sights generally operate on the principles of convection, conduction, and radiation (mentioned in chapter 2 of this publication). The sight “picks up” or translates the IR wavelength (or light) that is emitted from a target scene through one of those three methods.

3-13. Things to be aware of (planning considerations) with these optics are that they have difficulty imaging through the following:

- **Rain** – absorbs the IR emitted by the target, makes it difficult to see.
- **Water** – acts as a mirror and generally reflects IR, providing a false thermal scene.
- **Glass** – acts similar to water, interfering with the sensor’s ability to accurately detect emitted radiation behind the glass.

3-14. Situations where IR can see better are the following:

- **Smoke** – will not obscure a target unless the chemical obscurant is extremely hot and dense, or if the target is sitting on top of the smoke source.
- **Dust** – may interfere with the accurate detection of the emitted thermal signature due to dust and debris density between the sensor and the target scene. Dust typically does not obscure the IR signature unless its temperature is similar to the target’s.

3-15. Figure 3-5 depicts the areas of the electromagnetic spectrum. It details the various wavelengths within the spectrum where the aiming devices, night vision devices, and equipment operate. It illustrates where these items can and cannot “see” the others, respectively, within their operating range.

Aiming Devices

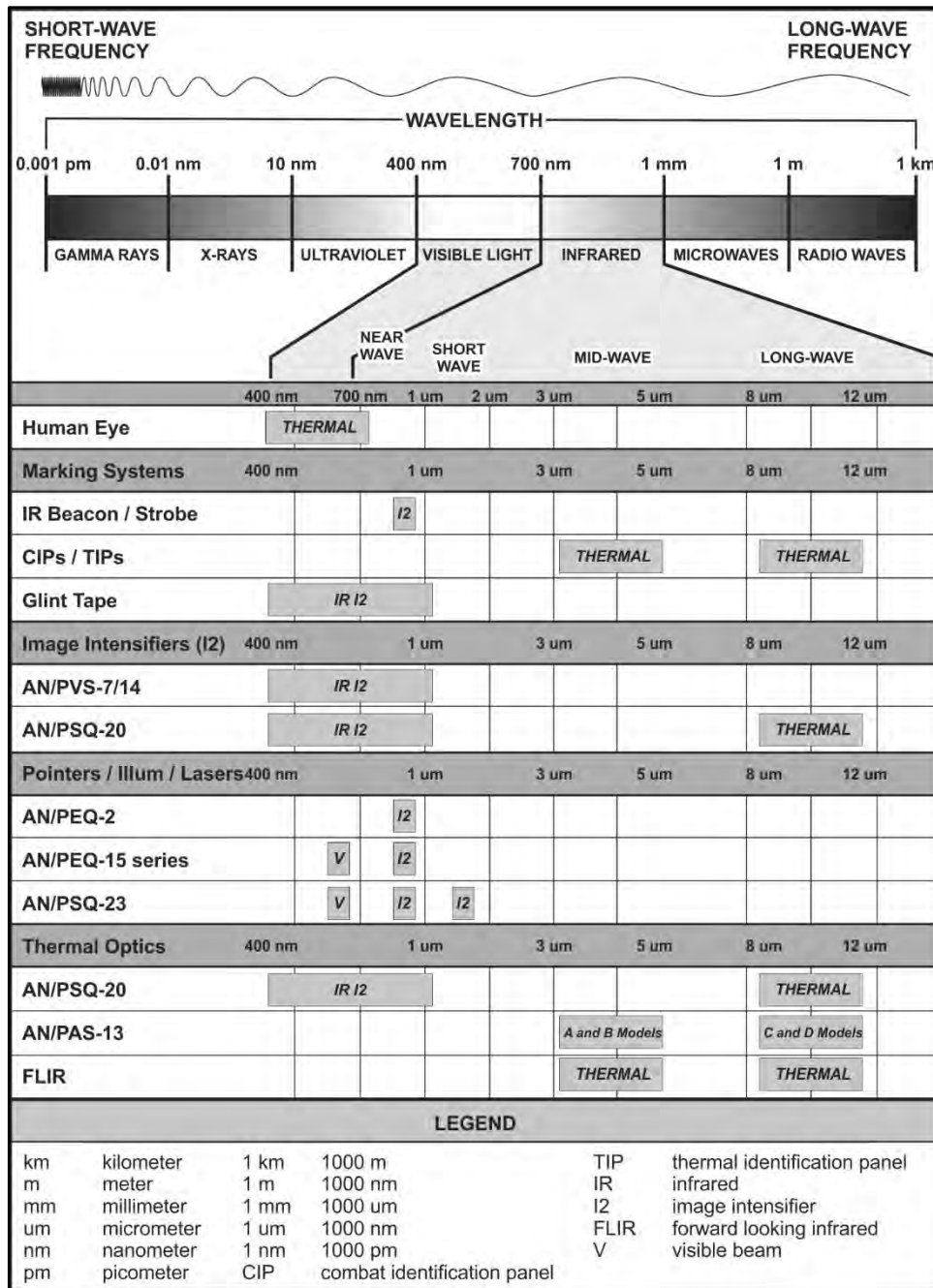

Figure 3-5. Electromagnetic spectrum

## Chapter 3

---

### OPTICS

3-16. Optics are sighting aids for rifles and carbines that provide enhanced aim point reticles, and may include magnified fields of view. Optics are specific to day operations, although may be used during limited visibility or night operations. They do not have any method of enhancing low light conditions.

3-17. Optics enhance the Soldier's ability to engage targets accurately and at extended ranges (see figure 3-6 on page 3-9). The available optics for mounting on the M4- and M16-series modular weapon system are:

- Iron Sight.
- Back Up Iron Sight (BUIS).
- CCO, M68.
- RCO, M150.

### IRON SIGHT

3-18. Some versions of the M4 and M16 come with a carrying handle with an integrated rear aperture. The carrying handle may or may not be removable, depending on the version of the service rifle.

3-19. The integrated rear aperture includes adjustments for both azimuth (wind) and elevation. Specific instructions for zeroing these aiming devices are found in the respective weapon's technical manual.

3-20. The carrying handle has two selectable apertures for the engagement situation:

- Small aperture. Used for zeroing procedures and for mid- and extended-range engagements.
- Large aperture. Used during limited visibility, close quarters, and for moving targets at close or mid-range.

3-21. The iron sight uses the fixed front sight post to create the proper aim. Soldiers use the front sight post centered in the rear aperture. The following information is extracted from the weapon's technical manual.

**Aiming Devices**

	<b>CARRYING HANDLE</b>				
	<b>DIMENSIONS</b>				
	<b>LENGTH</b>	7.3 in      18.5 cm			
	<b>WIDTH</b>	3.5 in      9.0 cm			
	<b>HEIGHT</b>	1.9 in      4.8 cm			
<b>WEIGHT</b>	20.8 oz      590 g				
<b>FUNCTION</b>	<b>RIFLE</b>	<b>ADJUSTMENTS</b>			
ZERO WINDAGE	M16A2	Center rear sight aperture for mechanical zero windage			
	M16A4				
	M4				
	M4A1				
ZERO ELEVATION	M16A2	300 meter mark +1 click up for 25 m zeroing  Once zeroing is complete, rotate elevation knob -1 click down to apply 300 m zero			
	M16A4				
	M4				
	M4A1				
WINDAGE	M16A2	1/2 MOA			
	M16A4	1/2 MOA			
	M4	1 MOA			
	M4A1	1 MOA			
ELEVATION (RANGE) FRONT SIGHT POST	M16A2	1 1/2 MOA			
	M16A4	1 1/2 MOA			
	M4	1 7/8 MOA			
	M4A1	1 7/8 MOA			
<b>LEGEND</b>					
BDC	bullet drop compensator	g	grams	MOA	minute of angle
cm	centimeters	in	inches	oz	ounces

**Figure 3-6. Carrying handle with iron sight example**

**Chapter 3**

**BACK UP IRON SIGHT**

3-22. The BUIS is a semi-permanent flip-up sight equipped with a rail-grabbing base. The BUIS provides a backup capability effective out to 600 meters and can be installed on M16A4 rifles and M4-series carbines. (See figure 3-7.)

3-23. The BUIS on the first notch of the integrated rail, nearest to the charging handle. The BUIS remains on the modular weapon system (MWS) unless the carrying handle/sight is installed. The following information is extracted from the weapon's technical manual.

	BACK UP IRON SIGHT (BUIS)	
	DIMENSIONS	
	LENGTH	2.1 in 5.3 cm
	WIDTH	1.3 in 3.3 cm
	HEIGHT	1.5 in 3.8 cm
WEIGHT	4.3 oz 122 g	
FUNCTION	SINGLE CLICK	
ZERO WINDAGE	M16A4	White Line
	M4	White Line
	M4A1	White Line
ZERO ELEVATION	M16A4	White Line
	M4	300 meter setting
	M4A1	300 meter setting
WINDAGE	M16A4	1/2 MOA
	M4	3/4 MOA
	M4A1	3/4 MOA
ELEVATION (RANGE) FRONT SIGHT POST	M16A4	1 1/2 MOA
	M4	2 MOA
	M4A1	2 MOA
LEGEND		
cm	centimeters	in inches
g	grams	oz ounces
	MOA	minute of angle

**Figure 3-7. Back up iron sight**

---

**Aiming Devices**

---

**CLOSE COMBAT OPTIC, M68**

3-24. The close combat optic (CCO), M68 is a non-telescopic (unmagnified) reflex sight that is designed for the “eyes-open” method of sighting (see figure 3-8). It provides Soldiers the ability to fire with one or two eyes open, as needed for the engagement sequence in the shot process.

3-25. The CCO provides a red-dot aiming point using a 2 or 4 MOA diameter reticle, depending on the variant. The red dot aiming point follows the horizontal and vertical movement of the firer’s eye, allowing the firer to remain fixed on the target. No centering or focusing on the front sight post is required. There are three versions of the CCO available in the force.

---

*Note.* Re-tighten the torque-limiting knob after firing the first three to five rounds to fully seat the M68.

---

3-26. The CCO is zeroed to the weapon. It must remain matched with the same weapon, attached at the same slot in the attached rail system or be re-zeroed. If the CCO must be removed for storage, Soldiers must record the serial number and the rail slot to retain zero.

---

*Note.* The weapon must be re-zeroed if the CCO is not returned to the same rail slot on the adaptive rail system.

---

**Advantages**

3-27. The CCO offers a distinct speed advantage over iron sights in most if not all engagements. The adjustments on brightness allow the Soldier to have the desired brightness from full daylight to blackout conditions.

3-28. The CCO is the preferred optic for close quarter’s engagements.

**Disadvantages**

3-29. The CCO lacks a bullet drop compensator or other means to determine accurate range to target beyond 200m.

3-30. The following information is an extract from the equipment’s technical manual for Soldier reference.

**Chapter 3**

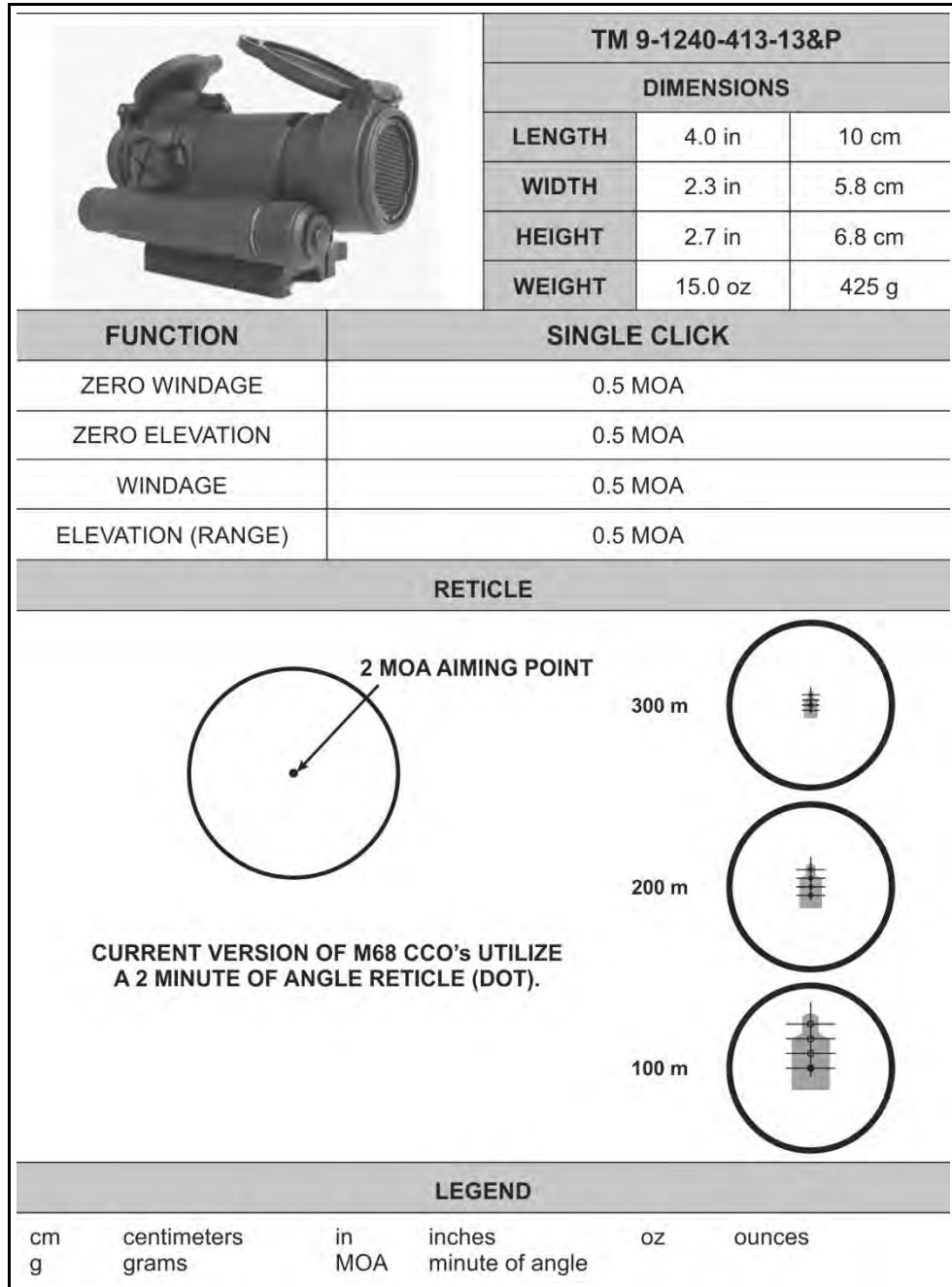

**Figure 3-8. CCO Reticle, Comp M2 examples**

## RIFLE COMBAT OPTIC

3-31. The RCO (see figure 3-9) is designed to provide enhanced target identification and hit probability for the M4-/M4A1- or M16-series weapon.

3-32. There are several versions of the RCO available for use across the force. Soldiers must be familiar with their specific version of their assigned RCO, and be knowledgeable on the specific procedures for alignment and operation (see figure 3-9 for RCO azimuth and elevation adjustments).

3-33. The reticle pattern provides quick target acquisition at close combat ranges to 800 meters using the bullet drop compensator (BDC) (see figure 3-10 on page 3-15). It is designed with dual illuminated technology, using fiber optics for daytime employment and tritium for nighttime and low-light use.

3-34. The RCO is a lightweight, rugged, fast, and accurate 4x power optic scope specifically designed to allow the Soldier to keep both eyes open while engaging targets and maintain maximum situational awareness.

### Advantages

3-35. The bullet drop compensator (BDC) is accurate for extended range engagements using either M855 or M855A1 ball ammunition. The ballistic difference between the two rounds is negligible under 400 meters and requires no hold determinations.

3-36. This is a widely fielded optic that is rugged, durable, and operates in limited light conditions. The self-illuminating reticle allows for continuous operations through end evening nautical twilight (EENT).

### Disadvantages

3-37. This optic's ocular view is limited when engaging targets in close quarters engagements. This requires additional training to master the close quarter's skills while employing the RCO to achieve overmatch against the threat.

3-38. The RCO reticle does not include stadia lines. Windage must be applied by the shooter from a determined estimate. The RCO has a specific eye relief of 70-mm (millimeter) or 1.5 inches. If the eye relief is not correct, the image size will be reduced.

3-39. The fiber optic illuminator element can provide excessive light to the reticle during certain conditions that produce a glare. The RCO does not have a mechanical or built in method to reduce the effects of the glare created. The increased lighting may interfere with the shooter's point of aim and hold determinations. Soldiers may use alternate methods to reduce the glare by reducing the amount of fiber optic exposed to direct sunlight during operating conditions.

3-40. The following information is an extract from the equipment's technical manual for Soldier reference.



Chapter 3

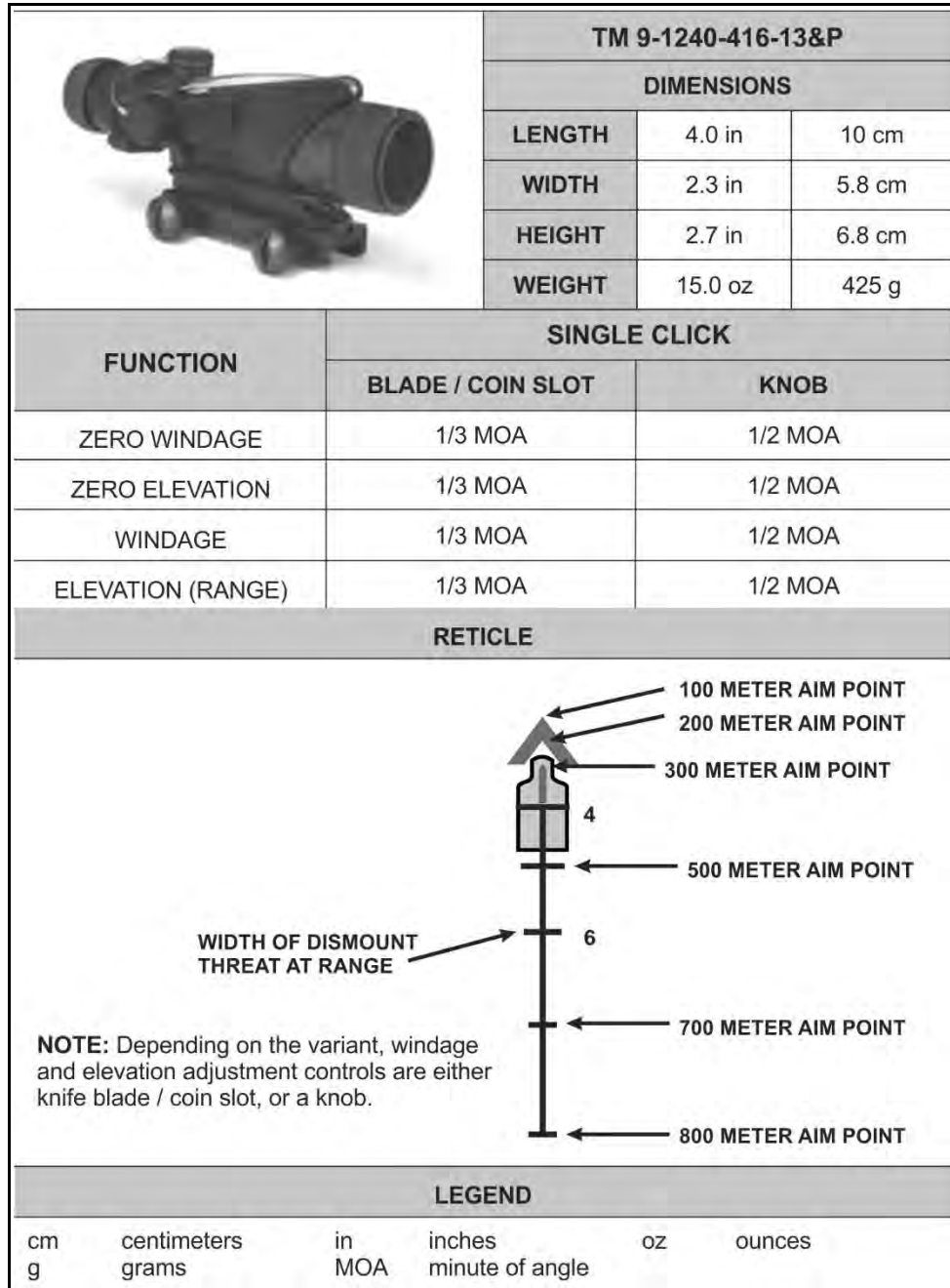

Figure 3-9. RCO reticle example

## THERMAL SIGHTS

3-41. Thermal sights are target acquisition and aiming sensors that digitally replicate the field of view based on an estimation of the temperature. They use advanced forward-looking infrared technology that identify the infrared emitted radiation (heat) of a field of view, and translate those temperatures into a gray- or color-scaled image. The TWS is capable of target acquisition under conditions of limited visibility, such as darkness, smoke, fog, dust, and haze, and operates effectively during the day and night.

3-42. The TWS is composed of five functional groups: (See figure 3-10.)

- **Objective lens** – receives IR light emitting from an object and its surroundings. The objective lens magnifies and projects the IR light.
- **Detector assembly** – senses the IR light and converts it to a video signal.
- **Sensor assembly** – the sensor electronics processes the video for display on the liquid crystal display (LCD) array in the field of view.
- **LCD array/eyepiece** – the LCD array provides the IR image along with the reticle selected. The light from the LCD array is at the eyepiece.
- **User controls** – the control electronics allows the user to interface with the device to adjust contrast, thermal gain, sensitivity, reticle display, and magnification.

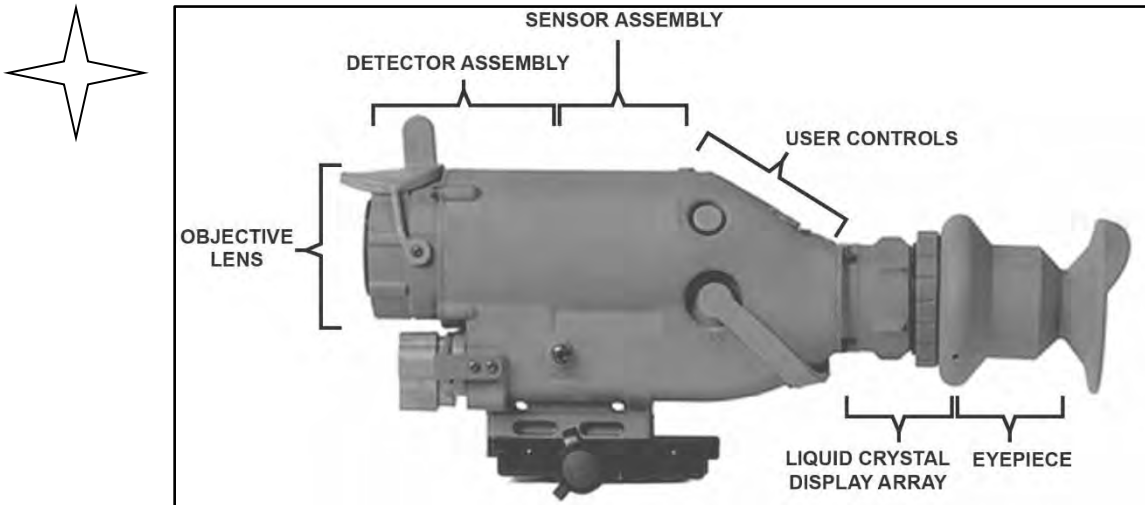

**Figure 3-10. Thermal weapon sight example**

3-43. A small detector used in thermal sensors or optics to identify IR radiation with wavelengths between 3 and 30  $\mu\text{m}$  (micrometer). The thermal optic calculates and processes the thermal scene into a correlating video image signal based on the temperature identified. These optics can differentiate thermal variations of 1 degree Celsius of the viewable scene. These variations generate a corresponding contrasting gradient that develops a thermal representation on the LCD screen in the eyepiece.

## Chapter 3

---

### AN/PAS-13 SERIES OF WEAPON THERMAL SIGHTS

3-44. There are several versions of weapons thermal sights (WTS) available for use across the force. Soldiers must be familiar with their specific model and version of their assigned weapon thermal sight, and be knowledgeable on the specific procedures for alignment and operation. The various models and versions are identified in their official model nomenclature:

- **Version 1 (v1)** – Light Weapons Thermal Sight (LWTS).
- **Version 2 (v2)** – Medium Weapons Thermal Sight (MWTS).
- **Version 3 (v3)** – Heavy Weapons Thermal Sight (HWTS).

3-45. Weapons thermal sights are silent, lightweight, and compact, and have durable battery-powered IR imaging sensors that operate with low battery consumption. (See figure 3-11.)

#### Advantages

3-46. Military grade weapon thermal weapon sights are designed with the following advantages:

- Small and lightweight.
- Real-time imagery. Devices provide real-time video of the thermal scene immediately after power on.
- Long-lasting battery life. Low power consumption over time.
- Reliable. Long mean time between failures (MTBF).
- Quiet. The lack of a cooling element allows for a very low operating noise level.
- One optic fits on multiple weapons. The use of the ARS rail mounting bracket allows for the same optic to be used on other weapons.
- The F- and G-models attach in front of other aiming devices to improve their capabilities and eliminate the zeroing procedures for the device.

#### Disadvantages

3-47. These devices have limitations that Soldiers should take into consideration, particularly during combat operations. The primary disadvantages are:

- Cannot interpret (“see”) multispectral infrared. These systems view a specific wavelength for emitted radiation (heat variations), and do not allow viewing of all aiming and marking devices at night.
- Reliance on rechargeable batteries and charging stations. Although the batteries are common and have a relatively long battery life, additional equipment is required to charge them. If common nonrechargeable (alkaline) batteries are used, a separate battery adapter is typically required.
- Cannot interpret thermal signatures behind glass or water effectively.
- Thermal systems cannot always detect friendly marking systems worn by dismounts.

**Aiming Devices**

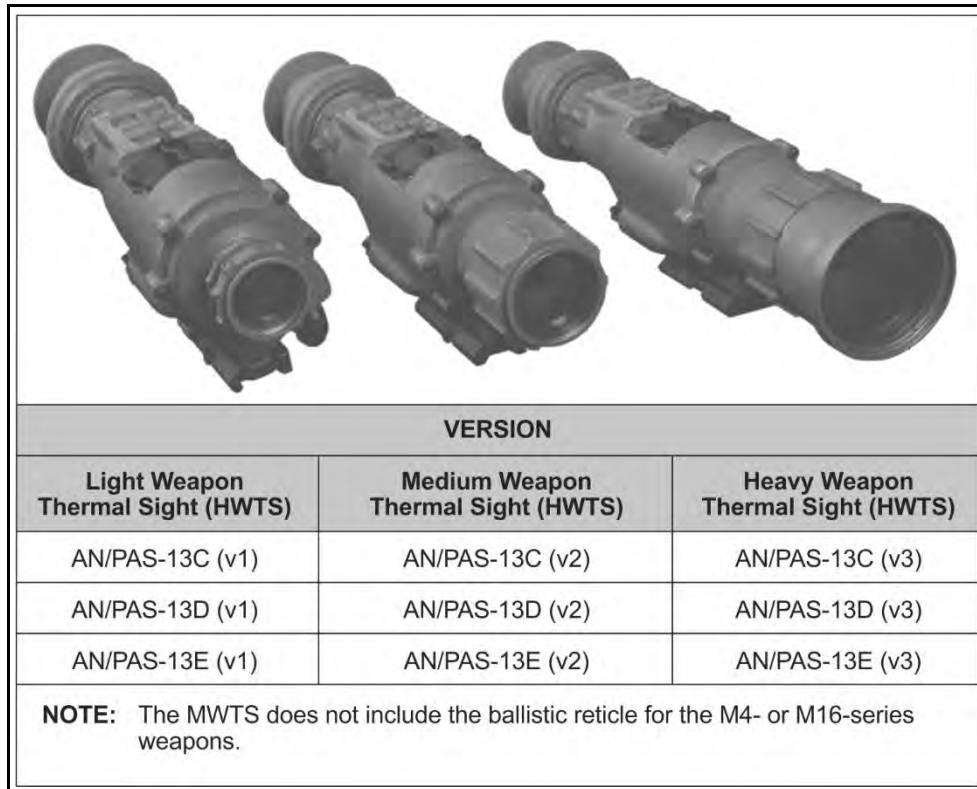

**Figure 3-11. Weapon thermal sights by version**

3-48. Thermal sight has a wide field of view and a narrow field of view (see figures 3-12 and 3-13).

Chapter 3

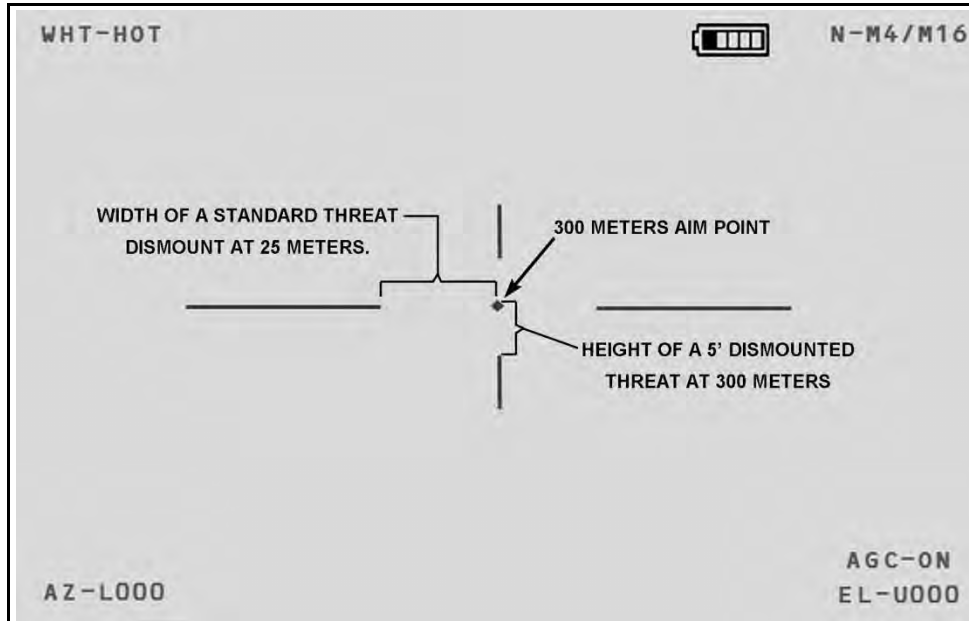

Figure 3-12. Thermal weapons sight, narrow field of view reticle example

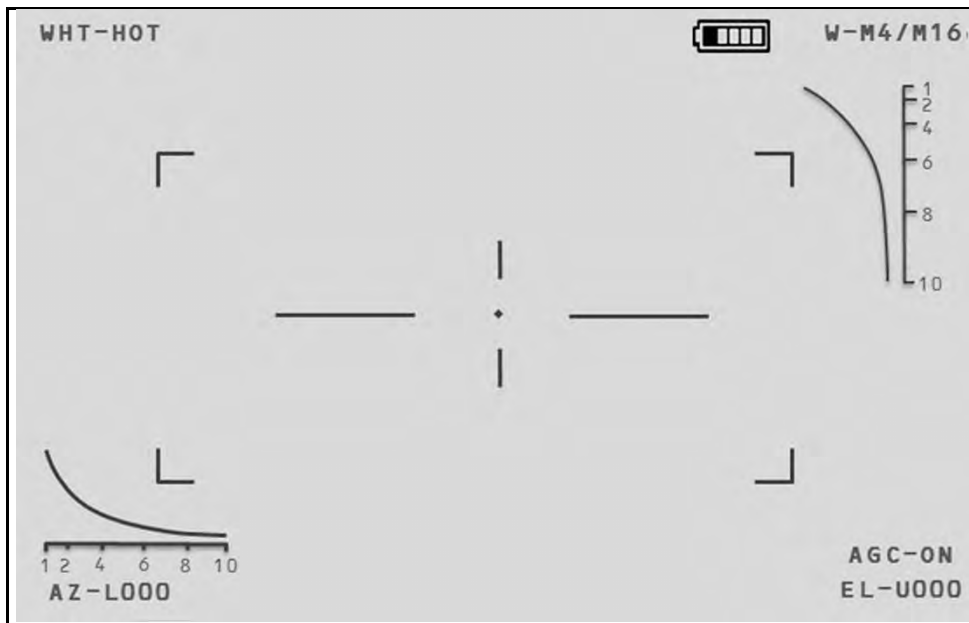

Figure 3-13. Thermal weapons sight, wide field of view reticle example

**POINTERS / ILLUMINATORS / LASERS**

3-49. Pointers, illuminators, and laser devices for small arms weapons emit a collimated beam of IR light for precise aiming and a separate IR beam for illumination. These devices operate in one single mode at a time, as selected by the user. The laser is activated by a selector switch on the device or by a remote mechanism installed on the weapon. The basic two modes or functions are:

- **Pointer.** When used as a pointer or aiming device, a small, pin-point beam is emitted from the device. The IR beam provides an infrared visible point when it strikes an object or target. The IR beam operates in the 400 to 800 nanometer wavelength and can only be seen by I2 optics, such as the AN-PVS-7 or -14 night vision devices.
- **Illuminator.** Typically used to illuminate a close quarters area as an infrared flood light. The illuminator provides a flood-light effect for the Soldier when used in conjunction with I2 night vision devices.

---

*Note.* Laser is an acronym for light amplified stimulated emitted radiation, but is predominantly used as a proper noun.

---

3-50. The following devices (see table 3-1) are the most common laser pointing devices available for use on the M4- and M16-weapons.

**Table 3-1. Laser Aiming Devices for the M4 and M16**

Laser Aiming Device	Device Name	Reference
AN/PEQ-2	Target Pointer/Illuminator/Aiming Light (TPIAL)	TM 9-5855-1915-13&P
AN/PEQ-15	Advanced Target Pointer/Illuminator/Aiming Light (ATPIAL)	TM 9-5855-1914-13&P
AN/PEQ-15A	Dual Beam Aiming Laser – Advanced2 (DBAL-A2)	TM 9-5855-1912-13&P
AN/PSQ-23	Illuminator, Integrated, Small Arms (STORM)	TM 9-5855-1913-13&P

---

*Note.* The ATPIAL, DBAL-A2, and STORM have collocated IR and visible aiming lasers. A single set of adjusters move both aiming beams. Although the aiming lasers are collocated, Soldiers should zero the laser they intend to use as their primary pointer to ensure accuracy and consistency during operation.

---

**Chapter 3**

---

**AN/PEQ-2 TARGET POINTER/ILLUMINATOR AIMING LIGHT (TPIAL)**

3-51. AN/PEQ-2 aiming devices are Class IIIb laser devices that emit a collimated beam of IR light for precise aiming and a separate IR beam for illumination of the target or target area (see figure 3-14 on page 3-21). Both beams can be independently zeroed to the weapon and to each other. The beams can be operated individually or in combination in both high and low power settings.

---

*Note.* The IR illuminator is equipped with an adjustable bezel to vary the size of the illumination beam based on the size and distance of the target.

---

3-52. The aiming devices are used with night observation devices (NODs) and can be used as handheld illuminators/pointers or mounted on the weapon with the included brackets and accessory mounts. In the weapon-mounted mode, the aiming devices can be used to direct fire and to illuminate and designate targets.

3-53. The aiming light is activated by pressing on either the ON/OFF switch lever, or the button on the optional cable switch. Either switch connects power from two AA batteries to an internal electronic circuit which produces the infrared laser. Internal lenses focus the infrared light into a narrow beam. The direction of the beam is controlled by rotating the mechanical Adjusters with click detents. These adjusters are used to zero the aiming light to the weapon.

3-54. Once zeroed to the weapon, the aiming light projects the beam along the line of fire of the weapon. The optical baffle prevents off-axis viewing of the aiming light beam by the enemy.

**CAUTION**

A safety block is provided for training purposes to limit the operator from selecting high power modes of operation.

3-55. The following information is an extract from the equipment's technical manual for Soldier reference.

**Aiming Devices**

				<b>TM 9-5855-1915-13&amp;P</b>			
				<b>DIMENSIONS</b>			
				<b>LENGTH</b>	6.4 in	16.3 cm	
				<b>WIDTH</b>	2.8 in	7.1 cm	
				<b>HEIGHT</b>	1.2 in	3 cm	
				<b>WEIGHT</b>	9.5 oz	269 g	
<b>POWER</b>							
<b>BATTERY LIFE</b>				100 hours >32°			
				36 hours <32°			
<b>POWER SOURCE</b>				2 each AA batteries			
<b>MODE OF OPERATION</b>							
<b>MODE</b>	<b>MARKINGS</b>		<b>TGT LASER</b>		<b>ILLUM LASER</b>		
0	OFF		OFF		OFF		
1	AIM LO		LOW POWER		OFF		
2	DUAL LO		LOW POWER		LOW POWER		
3	AIM HI		HIGH POWER		OFF		
4	DUAL LO/HI		HIGH POWER		LOW POWER		
5	DUAL HI		HIGH POWER		HIGH POWER		
<b>LASER</b>		<b>DIVERGENCE</b>			<b>WAVELENGTH</b>		
IR BEAM		0.3 mRad			820-850 nm		
IR ILLUMINATOR		3.0 mRad			820-850 nm		
<b>LEGEND</b>							
cm	centimeters	IR	infrared	oz	ounces		
g	grams	mRad	milliradians				
in	inches	nm	nanometers				

**Figure 3-14. AN/PEQ-2**



### Chapter 3

---

#### AN/PEQ-15 ADVANCED TARGET POINTER/ILLUMINATOR/AIMING LIGHT

3-56. The AN/PEQ-15 ATPIAL is a multifunctional laser that emits both a visible and IR light for precise weapon aiming and target/area illumination. This ruggedized system can be used as a handheld illuminator/pointer or can be mounted to weapons equipped with an M4- or M5-ARS (Military Standard [MIL STD] 1913).

- **Visible light** – can be used to boresight the device to a weapon without the need of night vision goggles. A visible red-dot aiming laser can also be selected to provide precise aiming of a weapon during daylight or night operations.
- **Infrared laser** – emit a highly collimated beam of IR light for precise weapon aiming. A separate IR-illuminating laser can be adjusted from a flood light mode to a single point spot-divergence mode.

3-57. The lasers can be used as handheld illuminator pointers, or can be weapon-mounted with included hardware. The co-aligned visible and IR aiming lasers emit through laser ports in the front of the housing. These highly capable aiming lasers allow for accurate nighttime aiming and system boresighting.

3-58. The AN/PEQ-15 has an integrated rail grabber molded into the body to reduce weight and additional mounting hardware. (Refer to TM 9-5855-1914-13&P for more information.)

#### CAUTION

The AN/PEQ-15 can be used during force-on-force training in the low power modes only. High power modes can be used on live-fire ranges exceeding 220 meters only.

3-59. The AN/PEQ-15, ATPIAL's (see figure 3-15 on page 3-23) visible aiming laser provides for active target acquisition in low light conditions and close-quarters combat situations, and allows users to zero using the borelight without using NOD. When used in conjunction with NODs, its IR aiming and illumination lasers provide for active, covert target acquisition in low light or complete darkness.

3-60. The ATPIAL visible and IR aiming lasers are co-aligned. A single set of adjusters moves both aiming beams, and the user can boresight/zero using either aiming laser. The following information is an extract from the equipment's technical manual for Soldier reference.

**Aiming Devices**

			<b>TM 9-5855-1914-13&amp;P</b>		
			<b>DIMENSIONS</b>		
			<b>LENGTH</b>	4.6 in	11.7 cm
			<b>WIDTH</b>	2.8 in	7.1 cm
			<b>HEIGHT</b>	1.9 in	4.1 cm
<b>WEIGHT</b>	7.5 oz	213 g			
<b>POWER</b>					
<b>BATTERY LIFE</b>			>6 hours in DUAL HIGH (DH) mode		
<b>POWER SOURCE</b>			1 each DL-123A, 3 volt		
<b>MODE OF OPERATION</b>					
<b>POSITION</b>	<b>MODE</b>	<b>REMARKS</b>			
VIS AL	Vis Aiming Laser	Visible Aim Laser ON			
O	OFF	Prevents inadvertent laser burst			
P	Program	Sets the desired IR pulse rate			
AL	AIM LOW	Low power of Aiming Laser			
DL	DUAL LOW	Aiming Laser and Illuminator on LOW			
AH	AIM HIGH	Aiming Laser set to HIGH			
IH	ILLUM HIGH	IR Illuminator set to HIGH			
DH	DUAL HIGH	IR Aim and Illuminator set to HIGH			
<b>LASER</b>		<b>DIVERGENCE</b>		<b>WAVELENGTH</b>	
IR BEAM		0.5 mRad		820-850 nm	
IR ILLUMINATOR		1.0 to 105 mRad		820-850 nm	
VISIBLE AIMING		0.5 mRad		605-665 nm	
<b>LEGEND</b>					
cm	centimeters	IR	infrared	oz	ounces
g	grams	mRad	milliradians		
in	inches	nm	nanometers		

**Figure 3-15. AN/PEQ-15, ATPIAL**

### Chapter 3

---

#### AN/PEQ-15A, DUAL BEAM AIMING LASER – ADVANCED2

3-61. The AN/PEQ-15A DBAL-A2 is a multifunctional laser device that emits IR pointing and illumination light, as well as a visible laser for precise weapon aiming and target/area illumination. The visible and IR aiming lasers are co-aligned enabling the visible laser to be used to boresight both aiming lasers to a weapon without the need for night vision devices. This ruggedized system can be used as a handheld illuminator/pointer or can be mounted to weapons equipped with an M4 or M5 adapter rail system (MIL-STD-1913).

- **Visible light** – can be used to boresight the device to a weapon without the need of night vision goggles. A visible red-dot aiming laser can also be selected to provide precise aiming of a weapon during daylight or night operations.
- **Infrared laser** – emits a tightly focused beam of IR light for precise aiming of the weapon. A separate IR illumination provides supplemental IR illumination of the target or target area. The IR illuminator is equipped with an adjustable bezel to vary the size of the illumination beam on the size and distance to the target (flood to point divergence).

3-62. The lasers can be used as hand-held illuminator pointers, or can be weapon-mounted with included hardware. These highly capable aiming lasers allow for accurate nighttime aiming and system boresighting.

3-63. The AN/PEQ-15A, DBAL-A2 (see figure 3-16 on page 3-25) visible aiming laser provides for active target acquisition in low light conditions and close quarters combat situations, and allows users to zero using the borelight without using NODs. When used in conjunction with NODs, its IR aiming and illumination lasers provide for active, covert target acquisition in low light or complete darkness.

3-64. The DBAL-A2 visible and IR aiming lasers are co-aligned. A single set of adjusters moves both aiming beams, and the user can boresight/zero using either aiming laser. The following information is an extract from the equipment's technical manual for Soldier reference.

**Aiming Devices**

			<b>TM 9-5855-1912-13&amp;P</b>		
			<b>DIMENSIONS</b>		
			<b>LENGTH</b>	3.5 in	8.7 cm
			<b>WIDTH</b>	2.9 in	7.4 cm
			<b>HEIGHT</b>	1.9 in	4.8 cm
			<b>WEIGHT</b>	8 oz	224 g
<b>POWER</b>					
<b>BATTERY LIFE</b>			>5.5 hours in IR DUAL HIGH mode		
<b>POWER SOURCE</b>			1 each DL-123A, 3 volt		
<b>MODE OF OPERATION</b>					
<b>POSITION</b>	<b>MODE</b>	<b>REMARKS</b>			
AL	LOW POWER	Low power for aim laser			
AH	HIGH POWER	High power for aim laser			
VIS A	VIS AIM RED	Aiming or marking laser for daylight			
VIS A	VIS AIM GREEN	Aiming or marking laser for daylight			
<b>LASER</b>		<b>DIVERGENCE</b>		<b>WAVELENGTH</b>	
IR BEAM		0.3 mRad		840 nm	
IR ILLUMINATOR		0.5 to 75 mRad		840 nm	
VISIBLE AIM, RED		0.3 mRad		635 nm	
VISIBLE AIM, GREEN		0.5 mRad		532 nm	
<b>LEGEND</b>					
cm	centimeters	IR	infrared	oz	ounces
g	grams	mRad	milliradians		
in	inches	nm	nanometers		

**Figure 3-16. AN/PEQ-15A, DBAL-A2**

### Chapter 3

---

#### AN/PSQ-23, ILLUMINATOR, INTEGRATED, SMALL ARMS

3-65. The AN/PSQ-23 is a battery operated laser range finder (LRF) and digital magnetic compass (DMC) with integrated multifunctional lasers. The illuminator, integrated, small arms device is commonly referred to as the STORM laser. The visible and IR aiming lasers are co-aligned enabling the visible laser to be used to boresight both aiming lasers to a weapon without the need for night vision devices. This ruggedized system can be used as a handheld illuminator/pointer or can be mounted to weapons equipped with an M4 or M5 adapter rail system (MIL-STD-1913).

- **Laser range finder** – provides range to target information from 20 meters to 10,000 meters with an accuracy of +/- 1.5 meters.
- **Digital magnetic compass** – provides azimuth information and limited elevation information to the operator. The azimuth accuracy is +/- 0.5 degrees to +/- 1.5 degrees. The elevation accuracy is +/- 0.2 degrees. The DMC can identify bank or slopes up to 45 degrees with an accuracy of +/- 0.2 degrees.
- **Visible light** – provides for active target acquisition in low light and close quarters combat situations without the need for night vision devices. It can be used to boresight the device to a weapon without the need of night vision devices. A visible red-dot aiming laser can also be selected to provide precise aiming of a weapon during daylight or night operations.
- **Infrared laser** – emits a tightly focused beam of IR light for precise aiming of the weapon. A separate IR illumination provides supplemental IR illumination of the target or target area. The IR illuminator is equipped with an adjustable bezel to vary the size of the illumination beam on the size and distance to the target (flood to point divergence).
- **Infrared illuminator** – the STORM features a separately adjustable IR illuminator with adjustable divergence. It is fixed in the device housing and is set parallel to the rail mount.

---

*Note.* The STORM's LRF and DMC may be used in combination to obtain accurate positioning information for targeting purposes and other tactical applications.

---

3-66. The integrated visible aim laser (VAL) and illumination lasers provide for active, covert target acquisition in low light or complete darkness when used in conjunction with night vision devices. The STORM is also equipped with a tactical engagement simulation (TES) laser allowing it to be used in a laser-based training environment.

3-67. The AN/PEQ-15A, DBAL-A2 visible aiming laser provides for active target acquisition in low light conditions and close-quarters combat situations, and allows users to zero using the borelight without using NODs. When used in conjunction with NODs, its IR aiming and illumination lasers provide for active, covert target acquisition in low light or complete darkness. The following information is an extract from the equipment's technical manual for Soldier reference (see figure 3-17 on page 3-27).

**Aiming Devices**

			<b>TM 9-5855-1913-13&amp;P</b>		
			<b>DIMENSIONS</b>		
			<b>LENGTH</b>	7.3 in	18.5 cm
			<b>WIDTH</b>	3.5 in	9.0 cm
			<b>HEIGHT</b>	1.9 in	4.8 cm
<b>WEIGHT</b>	20.8 oz	590 g			
<b>POWER</b>					
<b>BATTERY LIFE</b>			>5.5 hours in IR DUAL HIGH mode		
<b>POWER SOURCE</b>			2 each DL-123A, 3 volt		
<b>MODE OF OPERATION</b>					
<b>POSITION</b>	<b>MODE</b>	<b>REMARKS</b>			
VH	VIS HIGH	Aiming or marking in daylight/indoor			
AH	AIM HIGH	IR operates on high power			
IH	ILLUM HIGH	IR illum operates on high power			
DH	DUAL HIGH	IR/Illum both operate on high power			
<b>BUTTON</b>	<b>MODE</b>	<b>REMARKS</b>			
L	Laser activate	Activates aiming laser			
R	Range/Compass	Press/Hold 3 sec to enter menu power			
<b>LASER</b>		<b>DIVERGENCE</b>		<b>WAVELENGTH</b>	
IR BEAM		0.5 mRad		820-850 nm	
IR ILLUMINATOR		1.0 to 100 mRad		820-850 nm	
VISIBLE AIM, RED		0.5 mRad		605-665 nm	
LASER RANGE FINDER		1.0 mRad		1570 nm	
<b>LEGEND</b>					
cm	centimeters	IR	infrared	oz	ounces
g	grams	mRad	milliradians		
in	inches	nm	nanometers		

**Figure 3-17. AN/PSQ-23, STORM**

This page intentionally left blank.

## Chapter 4

# Mountable Equipment

Both the M4- and M16-series of weapons have a wide variety of attachments to increase Soldier lethality, situational awareness, and overmatch. The attachments can be applied in various locations on the weapon system. Soldiers must understand what the attachments are, how they are correctly positioned, how to align them with the weapon system, and how to integrate them into use to maximize the system's capabilities.

This chapter explains how the ARS is used to mount the various attachments. It describes the weapons, aiming devices, and accessories available for mounting, and includes general information on the proper mounting location as well as their basic capabilities.

## ADAPTIVE RAIL SYSTEM

4-1. The ARS and rail grabbers are designed for M16- and M4-/M4A1-series weapons to mount:

- Weapons.
- Aiming devices.
- Accessories.

4-2. The ARS provides a secure mounting point for various accessories that may be mounted on the weapon's top, bottom, left, and right. Each rail groove has an incremental number identifying the slot location, starting from the rear of the weapon.

4-3. Soldiers should record the attachment or equipment's serial number (if applicable), the location of the attachment (for example, markings between lugs), and any boresight or alignment settings specific to the equipment at that location.

4-4. Once complete, the Soldier should mark the mounting bracket to identify the tightened position with a permanent marker. Marking the mounting bracket allows for rapid identification of loosening hardware during firing. Soldiers must periodically verify the mounting hardware does not loosen during operation. During zeroing or zero confirmation operations, Soldiers should retighten the mounting hardware after the first five rounds.

4-5. Soldiers must ensure the equipment is firmly affixed to the ARS before tie down is complete. If the attachments are loose, their accuracy and effectiveness will be degraded.



**Chapter 4**

---

**MOUNTABLE WEAPONS**

4-6. There are two types of weapons that can be physically attached to the M16-/M4-series rifles; grenade launchers and shotguns. These weapons are standard components of the unit's organizational equipment and serve specific purposes during combat operations.

4-7. These weapons are mounted under the barrel of the service rifle at specific locations. They may be removed by a qualified armorer only.

**GRENADE LAUNCHERS**

4-8. The M320/M320A1 grenade launcher is a lightweight grenade launcher that can operate in a stand-alone or attached configuration. The M320/M320A1 grenade launcher uses an integrated double-action-only trigger system. The M320 series is the replacement weapon for the M203. (See figure 4-1.)



**Figure 4-1. M320 attached to M4 series carbine example**

4-9. The M203 is a breach loaded attachable grenade launcher that is affixed to the bottom of the barrel of the M16-/M4-series rifle. The M203 cannot be used in a stand-alone configuration. (See figure 4-2)



**Figure 4-2. M203 grenade launcher example**

**Mountable Equipment**

4-10. Each mountable 40mm grenade launcher provides the following capabilities to the small unit (see the appropriate TM for authorized use):

- Pyrotechnic signal and spotting rounds:
  - Star cluster, white.
  - Star parachute, white.
  - Star parachute, green.
  - Star parachute, red.
  - Smoke, yellow.
  - Smoke, green.
  - Smoke, red.
  - Illumination, infrared.
- High explosive (HE).
- High explosive, dual purpose (HEDP).
- Nonlethal.
- Training practice (TP).

**SHOTGUN SYSTEM**

4-11. The M26 Modular Accessory Shotgun System (MASS) is an under-barrel shotgun attachment for the M16/M4/M4A1. The M26 uses a 3- or 5-round detachable box magazine and provides Soldiers with additional tactical capabilities. (Refer to TC 3-22.12 for more information). (See figure 4-3.)



**Figure 4-3. M26 shotgun example**

4-12. The M26 provides specific tactical capabilities to the Soldier using the following ammunition:

- Slug. Door breaching.
- Shot range, 00 buckshot.
- Nonlethal, rubber slug, buckshot, and riot control.

**Chapter 4**

**MOUNTABLE AIMING DEVICES**

4-13. Aiming devices mounted to the weapon system should be placed in a specific location on the weapon to maximize their capabilities. Table 4-1 provides the preferred mounting locations of the most common attachments.

**Table 4-1. Attachment Related Technical Manuals and Mounting**

Attachment	Technical Manual	M4/M4A1, M16A4	M4/M4A1	M16A2/A3
BUIS		UR	UR	
CCO, M68	TM 9-1240-413-13&P	UR*	UR*	MT
RCO, M150	TM 9-1240-416-13&P	UR	UR	MT
AN/PVS-14	TM 11-5855-306-10	UR***		
AN/PEQ-15A	TM 9-5855-1912-13&P	RG**	BA	BA
AN/PEQ-15	TM 9-5855-1914-13&P	RG**	BA	BA
AN/PAS-13B(V1), LWTS	TM 11-5855-312-10	UR	UR	MT
AN/PAS-13B(V3), HWTS	TM 11-5855-312-10	UR	UR	MT
AN/PAS-13C(V1), LWTS	TM 11-5855-316-10	UR	UR	MT
AN/PAS-13C(V3), HWTS	TM 11-5855-316-10	UR	UR	MT
AN/PAS-13D(V)1 LWTS	TM 11-5855-324-10	UR	UR	MT
AN/PAS-13D(V2), MWTS	TM 11-5855-317-10	UR	UR	MT
AN/PAS-13D(V3), HWTS	TM 11-5855-317-10	UR	UR	MT
AN/PSQ-23	TM 9-5855-1913-13&P	RG**	BA	BA
<b>Legend:</b> BA – Bracket Assembly BUIS – Back up Irion Sight CCO – Close Combat Optic HTWS – Heavy Thermal Weapons Sight LTWS – Light Thermal Sight MWTS – Medium Thermal Sight MT – M16 Mount RCO – Rifle Combat Optic RG – Rail Grabber UR – Upper Receiver * With a half-moon spacer installed. ** Picatinny or Insight rail grabbers may be used. *** If used in conjunction with the CCO, the CCO will mount on the top rail of the ARS.				

**Mountable Equipment**

**MOUNTABLE ACCESSORIES**

4-14. Mountable accessories are items that may be attached to a weapon but are not required for operation. They provide assistance stabilizing the weapon or provide white-light illumination for specific tactical operations.

4-15. These devices are authorized as needed by the small unit. Some mountable accessories are aftermarket (commercial-off-the-shelf, or COTS) items that use the ARS for semipermanent attachment.

**BIPOD**

4-16. Bipods are highly adjustable that enhance stability within the battle space environment. They are secured by the front sling swivel or the advanced rail system on the foregrip of the weapon. They can be used in combination with a sand sock or other buttstock support to provide an extremely stable firing platform. (See figure 4-4.)

4-17. The bipod is an additional means to stabilize the weapon in various shooting positions. Despite primarily being used in prone position, bipods can be used for additional support in alternate shooting positions while using barricade supports. The bipod provides additional support which facilitates acquisition of muscle relaxation and natural point of aim. The use of bipods in barricade shooting can increase the Soldier's efficiency and probability of a first round hit while engaging targets.



**Figure 4-4. Bipod example**

## Chapter 4

---

### VERTICAL FOREGRIP

4-18. Vertical foregrips (VFGs) assist in transitioning from target to target in close quarter combat. (See figure 4-5.)

4-19. The further out the Soldier mounts the VFG, the smoother and quicker his transitions between multiple targets will be, however he should not mount it so far forward that using the VFG is uncomfortable.



**Figure 4-5. Vertical foregrip example**

### FOREGRIP WITH INTEGRATED BIPODS

4-20. VFGs with integrated bipods are acceptable for common use. They combine the VFG capability with a small, limited adjustment bipod. They typically lack the full adjustment capabilities of full bipods, but provide a compact stable extrusion for the firer.

### MOUNTED LIGHTS

4-21. The weapon-mounted lights are commonly issued throughout the Army. The purpose of the weapon mounted lights is to provide illumination and assist in target acquisition and identification during limited visibility operations.

4-22. Most weapon mounted lights provide selection between white light and infrared capabilities. Employment of the weapon mounted light is based upon mission, enemy, terrain and weather, troops and support available, time available, civil considerations (METT-TC) and unit SOP. The weapon mounted lights should be mounted in such a manner that the Soldier can activate and deactivate them efficiently and their placement does not hinder the use of any other attachment or accessory. They must be attached in such a manner as to prevent negligent or unintentional discharge of white light illumination during movement or climbing.

## Chapter 5

# EMPLOYMENT

The rifleman's primary role is to engage the enemy with well-aimed shots. (Refer to ATP 3-21.8 for more information.) In this capacity, the rate of fire for the M4 rifle is not based on how fast the Soldier can pull the trigger. Rather, it is based on how fast the Soldier can consistently acquire and engage the enemy with accuracy and precision.

Consistently hitting a target with precision is a complex interaction of factors immediately before, during, and after the round fires. These interactions include maintaining postural steadiness, establishing and maintaining the proper aim on the target, stabilization of the weapon while pressing the trigger, and adjusting for environmental and battlefield conditions.

5-1. Every Soldier must adapt to the firing situation, integrate the rules of firearms safety, manipulate the fire control, and instinctively know when, how, and where to shoot. It is directly influenced by the Soldier's ability to hit the target under conditions of extreme stress:

- Accurately interpret and act upon perceptual cues related to the target, front and rear sights, rifle movement, and body movement.
- Execute minute movements of the hands, elbows, legs, feet, and cheek.
- Coordinate gross-motor control of their body positioning with fine-motor control of the trigger finger.

5-2. Regardless of the weapon system, the goal of shooting remains constant: well-aimed shots. To achieve this end state there are two truths. Soldier's must—

- Properly point the weapon (sight alignment *and* sight picture).
- Fire the weapon without disturbing the aim.

5-3. To accomplish this, Soldiers must master sight alignment, sight picture, and trigger control.

- **Sight alignment** – sight alignment is the relationship between the aiming device and the firer's eye. To achieve proper and effective aim, the focus of the firer's eye needs to be on the front sight post or reticle. The Soldier must maintain sight alignment throughout the aiming process.
- **Sight picture** – the sight picture is the placement of the aligned sights on the target.
- **Trigger control** – the skillful manipulation of the trigger that causes the rifle to fire without disturbing the aim.

**Chapter 5**

---

**SHOT PROCESS**

5-4. The **shot process** is the basic outline of an individual engagement sequence all firers consider during an engagement, regardless of the weapon employed. The shot process formulates all decisions, calculations, and actions that lead to taking the shot. The shot process may be interrupted at any point before the sear disengaging and firing the weapon should the situation change.

5-5. The shot process has three distinct phases:

- **Pre-shot.**
- **Shot.**
- **Post-shot.**

5-6. To achieve consistent, accurate, well-aimed shots, Soldiers must understand and correctly apply the shot process. The sequence of the shot process does not change, however, the application of each element vary based on the conditions of the engagement.

5-7. Every shot that the Soldier takes has a complete shot process. Grouping, for example, is simply moving through the shot process several times in rapid succession.

5-8. The shot process allows the Soldier to focus on one cognitive task at a time. The Soldier must maintain the ability to mentally organize the shot process’s tasks and actions into a disciplined mental checklist, and focus their attention on activities which produce the desired outcome; a well-aimed shot.

5-9. The level of attention allocated to each element during the shot process is proportional to the conditions of each individual shot. Table 5-1 provides an example of a shot process.

**Table 5-1. Shot Process example**

Pre-shot	Position
	Natural Point of Aim
	Sight Alignment / Picture
	Hold
Shot	Refine Aim
	Breathing Control
	Trigger Control
Post-shot	Follow-through
	Recoil management
	Call the Shot
	Evaluate

## FUNCTIONAL ELEMENTS OF THE SHOT PROCESS

5-10. Functional elements of the shot process are the linkage between the Soldier, the weapon system, the environment, and the target that directly impact the shot process and ultimately the consistency, accuracy, and precision of the shot. When used appropriately, they build a greater understanding of any engagement.

5-11. The functional elements are interdependent. A accurate shot, regardless of weapon system, requires the Soldier to establish, maintain, and sustain—

- **Stability** – the Soldier stabilizes the weapon to provide a consistent base to fire from and maintain through the shot process until the recoil pulse has ceased. This process includes how the Soldier holds the weapon, uses structures or objects to provide stability, and the Soldier’s posture on the ground during an engagement.
- **Aim** – the continuous process of orienting the weapon correctly, aligning the sights, aligning on the target, and the appropriate lead and elevation (hold) during a target engagement.
- **Control** – all the conscious actions of the Soldier before, during, and after the shot process that the Soldier specifically is in control of. The first of which is trigger control. This includes whether, when, and how to engage. It incorporates the Soldier as a function of safety, as well as the ultimate responsibility of firing the weapon.
- **Movement** – the process of the Soldier moving during the engagement process. It includes the Soldier’s ability to move laterally, forward, diagonally, and in a retrograde manner while maintaining stabilization, appropriate aim, and control of the weapon.

5-12. These elements define the tactical engagement that require the Soldier to make adjustments to determine appropriate actions, and compensate for external influences on their shot process. When all elements are applied to the fullest extent, Soldiers will be able to rapidly engage targets with the highest level of precision.

5-13. Time, target size, target distance, and the Soldier’s skills and capabilities determine the amount of effort required of each of the functional elements to minimize induced errors of the shot.

5-14. Each weapon, tactical situation, and sight system will have preferred techniques for each step in the shot process and within the functional elements to produce precision and accuracy in a timely manner. How fast or slow the shooter progresses through the process is based on target size, target distance, and shooter capability.

5-15. The most complex form of shooting is under combat conditions when the Soldier is moving, the enemy is moving, under limited visibility conditions. Soldiers and leaders must continue to refine skills and move training from the simplest shot to the most complex. Applying the functional elements during the shot process builds a firer’s speed while maintaining consistency, accuracy, and precision during complex engagements.

5-16. Each of the functional elements and the Soldier actions to consider during the shot process are described later in this manual.



## Chapter 5

---

### TARGET ACQUISITION

5-17. Target acquisition is the ability of a Soldier to rapidly recognize threats to the friendly unit or formation. It is a critical Soldier function before any shot process begins. It includes the Soldier's ability to use all available optics, sensors, and information to detect potential threats as quickly as possible.

5-18. Target acquisition requires the Soldier to apply an acute attention to detail in a continuous process based on the tactical situation. The target acquisition process includes all the actions a Soldier must execute rapidly:

- **Detect** potential threats (target detection).
- **Identify** the threat as friend, foe, or noncombatant (target identification).
- **Prioritize** the threat(s) based on the level of danger they present (target prioritization).

### TARGET DETECTION

5-19. Effective target detection requires a series of skills that Soldiers must master. Detection is an active process during combat operations with or without a clear or known threat presence. All engagements are enabled by the Soldier's detection skills, and are built upon three skill sets:

- **Scan and search** – a rapid sequence of various techniques to identify potential threats. Soldier scanning skills determine potential areas where threats are most likely to appear.
- **Acquire** – a refinement of the initial scan and search, based on irregularities in the environment.
- **Locate** – the ability to determine the general location of a threat to engage with accuracy or inform the small unit leader of contact with a potential threat.

### Scan and Search

5-20. Scanning and searching is the art of observing an assigned sector. The goal of the scan and search is a deliberate detection of potential threats based on irregularities in the surrounding environment. This includes irregular shapes, colors, heat sources, movement, or actions the Soldier perceives as being "out of place," as compared to the surrounding area.

5-21. Soldiers use five basic search and scan techniques to detect potential threats in combat situations:

- **Rapid scan** – used to detect obvious signs of threat activity quickly. It is usually the first method used, whether on the offense or fighting in the defense.
- **Slow scan** – if no threats are detected during the rapid scan, Soldiers conduct the more deliberate scan using various optics, aiming devices, or sensors. The slow scan is best conducted in the defense or during slow movement or tactical halts.

---

## Employment

- **Horizontal scan** – are used when operating in restricted or urban terrain. It is a horizontal sweeping scan that focuses on key areas where potential threats may be over watching their movement or position.
- **Vertical scan** – an up and down scan in restricted or urban environments to identify potential threats that may be observing the unit from an elevated position.
- **Detailed search** – used when no threats are detected using other scanning methods. The detailed search uses aiming devices, thermal weapon systems, magnified optics, or other sensors to slowly and methodically review locations of interest where the Soldier would be positioned if they were the threat (where would I be if I were them?)

### Acquire

5-22. Target acquisition is the discovery of any object in the operational environment such as personnel, vehicles, equipment, or objects of potential military significance. Target acquisition occurs during target scan and search as a direct result of observation and the detection process.

5-23. During the scan and search, Soldiers are looking for “target signatures,” which are signs or evidence of a threat. Tactically, Soldiers will be looking for threat personnel, obstacles or mines (including possible improvised explosive devices [IEDs]), vehicles, or anti-tank missile systems. These target signatures can be identified with sight, sound, or smell.

### Detection Best Practices

5-24. Threat detection is a critical skill that requires thoughtful application of the sensors, optics, and systems at the Soldier’s disposal. Finding potential threats as quickly and effectively as possible provides the maximum amount of time to defeat the threat. Soldiers should be familiar with the following best practices to increase target detection:

- Scan with the unaided eye first, then with a magnified optic.
- Practice using I2 and thermal optics in tandem during limited visibility.
- Understand the difference between I2 and thermal optics; what they can “see” and what they can’t. (See chapter 4 of this publication.)
- Thermal optics are the preferred sight for target acquisition and engagement, day or night.
- Don’t search in the same area as others in the small unit. Overlap, but do not focus on the same sector.
- Practice extreme light discipline during limited visibility including IR light discipline.
- Think as the threat. Search in areas that would be most advantageous from their perspective.
- Detecting threats is exponentially more difficult when operating in a chemical, biological, radiological, nuclear (CBRN) environment. Practice detection skills with personal protective equipment (PPE)/individual

## Chapter 5

---

protective equipment (IPE) and understand the increased constraints and limitations, day and night.

### Locate

5-25. Target location is the determination of where a target is in your operational environment in relation to the shooter, small unit, or element. Locating a target or series of targets occurs as a result of the search and acquisition actions of each Soldier in the small unit.

5-26. Once a target is located, the threat location can be rapidly and efficiently communicated to the rest of the unit. Methods used to announce a located target depend on the individual's specific position, graphic control measures for the operation, unit SOP, and time available.

### TARGET IDENTIFICATION

5-27. Identifying (or discriminating) a target as friend, foe, or noncombatant (neutral) is the second step in the target acquisition process. The Soldier must be able to positively identify the threat into one of three classifications:

- **Friend.** Any force, U.S. or allied, that is jointly engaged in combat operations with an enemy in a theater of operation.
- **Foe (enemy combatant).** Any individual who has engaged acts against the U.S. or its coalition partners in violation of the laws and customs of war during an armed conflict.
- **Noncombatants.** Personnel, organizations, or agencies that are not taking a direct part in hostilities. This includes individuals such as medical personnel, chaplains, United Nations observers, or media representatives or those out of combat such as the wounded or sick. Organizations like the Red Cross or Red Crescent can be classified as noncombatants.

5-28. The identification process is complicated by the increasing likelihood of having to discriminate between friend/foe and combatant/noncombatant in urban settings or restricted terrain. To mitigate fratricide and unnecessary collateral damage, Soldiers use all of the situational understanding tools available and develop tactics, techniques, and procedures for performing target discrimination.

### Fratricide Prevention

5-29. Units have other means of designating friendly vehicles from the enemy. Typically, these marking systems are derived from the unit tactical standard operating procedure (TACSOP) or other standardization publications, and applied to the personnel, small units, or vehicles as required:

- **Markings.** Unit markings are defined within the unit SOP. They distinctly identify a vehicle as friendly in a standardized manner.
- **Panels.** VS-17 panels provide a bright recognition feature that allows Soldiers to identify friendly vehicles through the day sight during unlimited visibility. Panels do not provide a thermal signature.

---

## Employment

---

- **Lighting.** Chemical or light emitting diode lights provide a means of marking vehicles at night. However, chemical lights are not visible through a thermal sight. An IR variant is available for use with night vision devices. Lighting systems do not provide for thermal identification during day or limited visibility operations.
- **Beacons and Strobes.** Beacons and strobes are unit-procured, small-scale, compact, battery-operated flashing devices that operate in the near infrared wavelength. They are clearly visibly through night vision optics, but cannot be viewed through thermal optics.

---

*Note.* Beacons and strobes generate illumination signals that can only be viewed by I2 optics. The signal *cannot be viewed* by thermal optics. Leaders and Soldiers are required to be aware of which optic can effectively view these systems when developing their SOPs and when using them in training or combat.

Beacons and strobes have the potential to be viewed by enemy elements with night vision capabilities. Units should tailor use of the beacon based on METT-TC.

---

- **Symbols.** Unit symbols may be used to mark friendly vehicles. An inverted V, for example, painted on the flanks, rear, and fronts of a vehicle, aid in identifying a target as friendly. These are typically applied in an area of operations and not during training. Symbol marking systems do not provide for thermal identification during day or limited visibility operations.

## TARGET PRIORITIZATION

5-30. When faced with multiple targets, the Soldier must prioritize each target and carefully plan his shots to ensure successful target engagement. Mental preparedness and the ability to make split-second decisions are the keys to a successful engagement of multiple targets. The proper mindset will allow the Soldier to react instinctively and control the pace of the battle, rather than reacting to the adversary threat.

5-31. Targets are prioritized into three threat levels—

- **Most dangerous.** A threat that has the capability to defeat the friendly force and is preparing to do so. These targets must be defeated immediately.
- **Dangerous.** A threat that has the capability to defeat the friendly force, but is not prepared to do so. These targets are defeated after all most dangerous targets are eliminated.
- **Least dangerous.** Any threat that does not have the ability to defeat the friendly force, but has the ability to coordinate with other threats that are more prepared. These targets are defeated after all threats of a higher threat level are defeated.

## Chapter 5

---

5-32. When multiple targets of the same threat level are encountered, the targets are prioritized according to the threat they represent. The standard prioritization of targets establishes the order of engagement. Firers engage similar threats by the following guide:

- **Near before far.**
- **Frontal before flank.**
- **Stationary before moving.**

5-33. The prioritization of targets provides a control mechanism for the shooter, and facilitates maintaining overmatch over the presented threats. Firers should be prepared deviate from the prioritization guide based on the situation, collective fire command, or changes to the target's activities.

## Chapter 6

# Stability

Stability is the ability of the Soldier to create a stable firing platform for the engagement. The Soldier stabilizes the weapon to provide a consistent base from which to fire from and maintain through the shot process until the recoil impulse has ceased. This process includes how the Soldier holds the weapon, uses structures or objects to provide stability, and the Soldier's posture on the ground during an engagement. A stable firing platform is essential during the shot process, whether the Soldier is stationary or moving.

This chapter provides the principles of developing a stable firing platform, describes the interaction between the Soldier, weapon, the surroundings, and the methods to achieve the greatest amount of stability in various positions. It explains how the stability functional element supports the shot process and interacts and integrates the other three elements. Stability provides a window of opportunity to maintain sight alignment and sight picture for the most accurate shot.

## SUPPORT

- 6-1. Stability is provided through four functions: support, muscle relaxation, natural point of aim, and recoil management. These functions provide the Soldier the means to best stabilize their weapon system during the engagement process.
- 6-2. The placement or arrangement of sandbags, equipment, or structures that directly provide support to the upper receiver of the weapon to provide increased stability. This includes the use of a bipod or vertical foregrip, bone and muscle support provided by the shooter to stabilize the rifle.
- 6-3. Support can be natural or artificial or a combination of both. Natural support comes from a combination of the shooter's bones and muscles. Artificial support comes from objects outside the shooter's body. The more support a particular position provides, the more stable the weapon.
  - **Leg Position.** The position of the legs varies greatly depending on the firing position used. The position may require the legs to support the weight of the Soldier's body, support the firing elbow, or to meet other requirements for the firing position. When standing unsupported, the body is upright with the legs staggered and knees slightly bent. In the prone, the firer's legs may be spread apart flat on the ground or bent at the knee. In the sitting position, the legs may also serve an intricate part of the firing position.

## Chapter 6

---

- **Stance/Center of Gravity.** The physical position of a Soldier before, during, and after the shot that relates to the firer's balance and posture. The position/center of gravity does not apply when firing from the prone position. The position/center of gravity specifically relates to the Soldier's ability to maintain the stable firing platform during firing, absorbing the recoil impulses, and the ability to aggressively lean toward the target area during the shot process.
- **Firing Elbow.** The placement of the firing elbow during the shot process. Proper elbow placement provides consistent firing hand grip while standing, sitting, or kneeling, and provides support stability in the prone position.
- **Nonfiring Elbow.** The Soldier's placement of the nonfiring elbow during the shot process supports the rifle in the all positions.
- **Firing Hand.** Proper placement of the firing hand will aid in trigger control. Place the pistol grip in the 'V' formed between the thumb and index finger. The pressure applied is similar to a firm handshake grip. Different Soldiers have different size hands and lengths of fingers, so there is no set position of the finger on the trigger. To grip the weapon, the Soldier places the back strap of the weapon's pistol grip high in the web of his firing side hand between his thumb and index (trigger) finger. The Soldier's trigger finger is indexed on the lower receiver, well outside the trigger guard and off the magazine release to prevent inadvertent release of the magazine. The firing hand thumb (or trigger finger for left-handed firers) is indexed on top of the safety selector switch. The Soldier grasps the pistol grip with his remaining three fingers ensuring there is no gap between his middle finger and the trigger guard.
- **Nonfiring Hand.** Proper placement of the non-firing hand is based on the firing position and placement of the non-firing elbow to provide the stability of the weapon. Placement is adjusted during supported and unsupported firing to maximize stability. The non-firing hand is placed as far forward as comfortable without compromising the other elements of the position or inducing extreme shooter-gun angle.
  - The nonfiring hand supports the weight of the rifle by grasping the fore arm. It should be a firm but relaxed grip. In all positions it should be as close to the handguard as naturally possible to aid in recoil management.
  - If possible, the firer should strive to have the thumb of the nonfiring hand provide downward force on the handguard. The pressure will provide the necessary force to assist in the management of the muzzle rise from recoil.
  - In all positions it should be as close to the end of the handguard as naturally possible to aid in recoil management.
  - Due to limited space on current MWS rails the above may not be possible but consideration should be given while mounting lasers to achieve an extended grip.
- **Butt Stock.** Correct placement of the butt stock in the firing shoulder will aid in achieving a solid stock weld. Side to side placement will vary

---

**Stability**

---

depending on equipment worn while firing. The butt stock is placed high enough in the shoulder to allow for an upright head position.

- The vertical placement of the butt stock will vary from firing position to firing position. A general guideline to follow is: the higher the position from the ground, the higher the butt stock will be in the shoulder.
- The term “butt stock” refers to both the butt stock (M16-series) and collapsible butt stock (M4-series) for clarity.
- **Stock Weld.** Stock weld is the placement of the firer’s head on the stock of the weapon. Correct stock weld is critical to sight alignment. The firer rests the full weight of the head on the stock. The head position is as upright as possible to give the best vision through the aiming device. It allows for scanning additional targets not seen through the aiming device.
  - When establishing the stock weld, bring the rifle up to your head, not your head down to the rifle. The firer’s head will remain in the same location on the stock while firing, but the location may change when positions are changed. The bony portion of the cheek placed on the stock is the basic starting point. Soldiers adapt to their facial structure to find the optimal placement that allows for both sight alignment and repetitive placement.
  - Figure 6-1 shows the differences in head placement, which effects sight alignment. The firer on the right is NOT resting the full weight of their head on the stock. The picture on the left shows the skin of the firer’s head being pushed down by the full weight of their head. This technique can be quickly observed and corrected by a peer coach.

---

*Note.* Soldiers’ bodies vary with the amount of flesh and the bone structure of the face. Firers who apply downward force simply to achieve the appearance in the correct (left) image in figure 6-1, on page 6-4, will not have relaxation and will not have a repeatable placement. The goal is to have alignment with consistent placement.

---



## Chapter 6

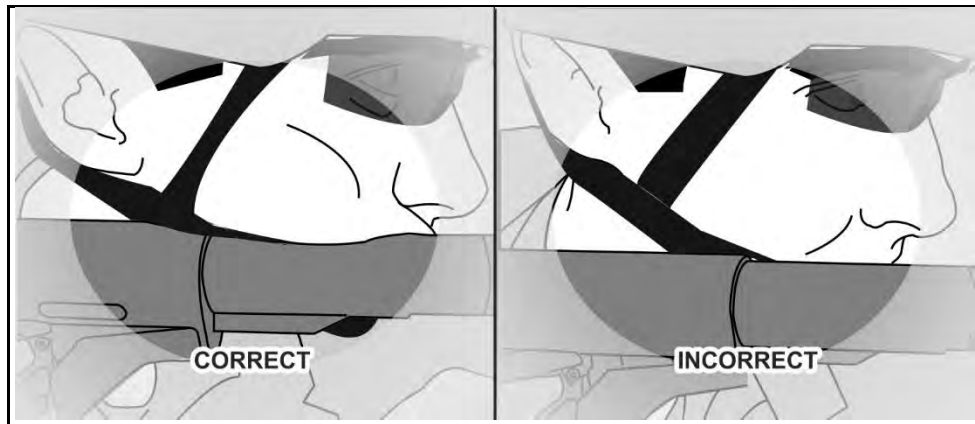

Figure 6-1. Stock weld

### MUSCLE RELAXATION

6-4. Muscle relaxation is the ability of the Soldier to maintain orientation of the weapon appropriately during the shot process while keeping the major muscle groups from straining to maintain the weapon system's position. Relaxed muscles contribute to stability provided by support.

- Strained or fatigued muscles detract from stability.
- As a rule, the more support from the shooter's bones the less he requires from his muscles.
- The more skeletal support, the more stable the position, as bones do not fatigue or strain.
- As a rule, the less muscle support required, the longer the shooter can stay in position.

### NATURAL POINT OF AIM

6-5. The natural point of aim is the point where the barrel naturally orients when the shooter's muscles are relaxed and support is achieved. The natural point of aim is built upon the following principles:

- The closer the natural point of aim is to the target, the less muscle support required.
- The more stable the position, the more resistant to recoil it is.
- More of the shooter's body on the ground equals a more stable position.
- More of the shooter's body on the ground equals less mobility for the shooter.

6-6. When a Soldier aims at a target, the lack of stability creates a wobble area, where the sights oscillate slightly around and through the point of aim. If the wobble area is larger than the target, the Soldier requires a steadier position or a refinement to their position to decrease the size of his wobble area before trigger squeeze.

---

**Stability**

---

*Note.* The steadier the position, the smaller the wobble area. The smaller the wobble area, the more precise the shot.

---

6-7. To check a shooter's natural point of aim, the Soldier should assume a good steady position and get to the natural pause. Close their eyes, go through one cycle, and then open their eyes on the natural pause. Where the sights are laying at this time, is the natural point of aim for that position. If it is not on their point of aim for their target, they should make small adjustments to their position to get the reticle or front sight post back on their point of aim. The Soldier will repeat this process until the natural point of aim is on the point of aim on their target.

## **RECOIL MANAGEMENT**

6-8. Recoil management is the result of a Soldier assuming and maintaining a stable firing position which mitigates the disturbance of one's sight picture during the cycle of function of the weapon.

6-9. The Soldier's firing position manages recoil using support of the weapon system, the weight of their body, and the placement of the weapon during the shot process. Proper recoil management allows the sights to rapidly return to the target and allows for faster follow up shots.

## **SHOOTER-GUN ANGLE**

6-10. The shooter gun-angle is the relationship between the shooters upper body and the direction of the weapon. This angle is typically different from firing position to firing position, and directly relates to the Soldier's ability to control recoil. Significant changes in the shooter-gun angle can result in eye relief and stock weld changes.

---

*Note.* Units with a mix of left and right handed shooters can take advantage of each Soldiers' natural carry positions, and place left-handed shooters on the right flanks, and right-handed shooters on the left flanks, as their natural carry alignment places the muzzle away from the core element, and outward toward potential threats, and reduces the challenges of firing when moving laterally.

---

## **FIELD OF VIEW**

6-11. The field of view is the extent that the human eye can see at any given moment. The field of view is based on the Soldier's view *without* using magnification, optics, or thermal devices. The field of view is what the Soldier sees, and includes the areas where the Soldier can detect potential threats.

**Chapter 6**

---

**CARRY POSITIONS**

6-12. There are six primary carry positions. These positions may be directed by the leader, or assumed by the Soldier based on the tactical situation. The primary positions are—

- Hang.
- Safe hang.
- Collapsed low ready.
- Low ready.
- High ready.
- Ready (or ready-up).

**Stability**

**HANG**

6-13. Soldiers use the hang when they need their hands for other tasks and no threat is present or likely (see figure 6-2). The weapon is slung and the safety is engaged. The hang carry should not be used when the weapon control status is RED. The reduced security of the weapon may cause the mechanical safety select lever to unintentionally move to SEMI or BURST/AUTO.

<b>Carry Position:</b>	<b>Hang</b>	<p>Weapon is slung from the firing shoulder across the chest to the non-firing hand.</p> <p>Magazine is secured in the magazine well based on the tactical situation.</p> <p>Weapon may have dust cap covering the muzzle.</p>
<b>When Used:</b>	No threat is likely or present. Typically used when not in a tactical environment.	
<b>Command:</b>	<b>ASSUME HANG</b>	
<b>Advantages:</b>	Provides the maximum amount of Soldier mobility and freedom of movement and use of their hands.	
<b>Disadvantages:</b>	Least accessibility to the weapon and the fire controls. Requires the most time to transition to a stable firing position. Maintains minimum amount of physical security.	

**Figure 6-2. Hang carry example**

**Chapter 6**

**SAFE HANG**

6-14. The safe hang is used when no immediate threat is present and the hands are not necessary (see figure 6-3). In the safe hang carry, the weapon is slung, the safety is engaged, and the Soldier has gripped the rifle's pistol grip. The Soldier sustains Rule 3, keeping the finger off the trigger until ready to engage when transitioning to the ready or ready up position.

6-15. In this position, the Soldier can move in any direction while simultaneously maintaining his muzzle oriented at the ground by using his firing hand. This carry provides control of the weapon, flexibility in movement, and positive control of the weapon's fire controls.

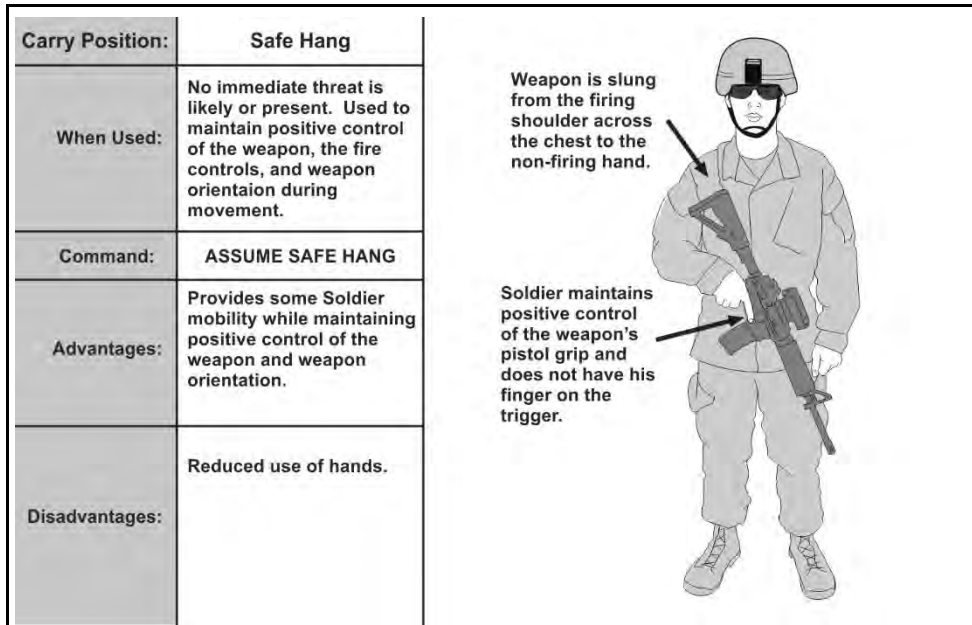

**Figure 6-3. Safe hang example**

**COLLAPSED LOW READY**

6-16. The collapsed low ready is used when a greater degree of muzzle control and readiness to respond to threats or weapon retention is necessary (such as crowded environments). In the collapsed low ready, the firing hand is secure on the weapon's pistol grip. The non-firing hand is placed on the hand guards or vertical foregrip (see figure 6-4).

6-17. This carry allows a Soldier to navigate crowded or restrictive environments while simultaneously minimizing or eliminating his muzzle covering (flagging) by maintaining positive control of the muzzle orientation.

<b>Carry Position:</b>	<b>Collapsed Low Ready</b>	<p>Weapon is slung from the firing shoulder across the chest to the non-firing hand.</p> <p>Soldier maintains positive control of the weapon's pistol grip and does not have his finger on the trigger.</p> <p>Non-firing hand placed on the hand guards or vertical grip.</p>
<b>When Used:</b>	A greater degree of muzzle control and readiness is required. Used in restricted or crowded environments, urban terrain, or when positive control of weapon orientation is required.	
<b>Command:</b>	<b>ASSUME COLLAPSED</b>	
<b>Advantages:</b>	Provides some Soldier mobility while maintaining positive control of the weapon and weapon orientation. Increased readiness.	
<b>Disadvantages:</b>	Use of hands limited.	

**Figure 6-4. Collapsed low ready example**

**Chapter 6**

**LOW READY**

6-18. The low ready provides the highest level of readiness and with the maximum amount of observable area for target acquisition purposes

6-19. In the low ready position, the weapon is slung, the butt stock is in the Soldier's shoulder, and the muzzle is angled down at a 30- to 45-degree angle and oriented towards the Soldier's sector of fire.

6-20. Firing hand is positioned on the pistol grip with the index finger straight and out of the trigger guard. The thumb is placed on the selector lever with the lever placed on safe. From this carry, the Soldier is ready to engage threats within a very short amount of time with minimal movement. (See figure 6-5).

6-21. Observation is maintained to the sector of fire. The Soldier looks over the top of his optics or sights to maintain situation awareness of his sector. The Soldier's head remains upright.

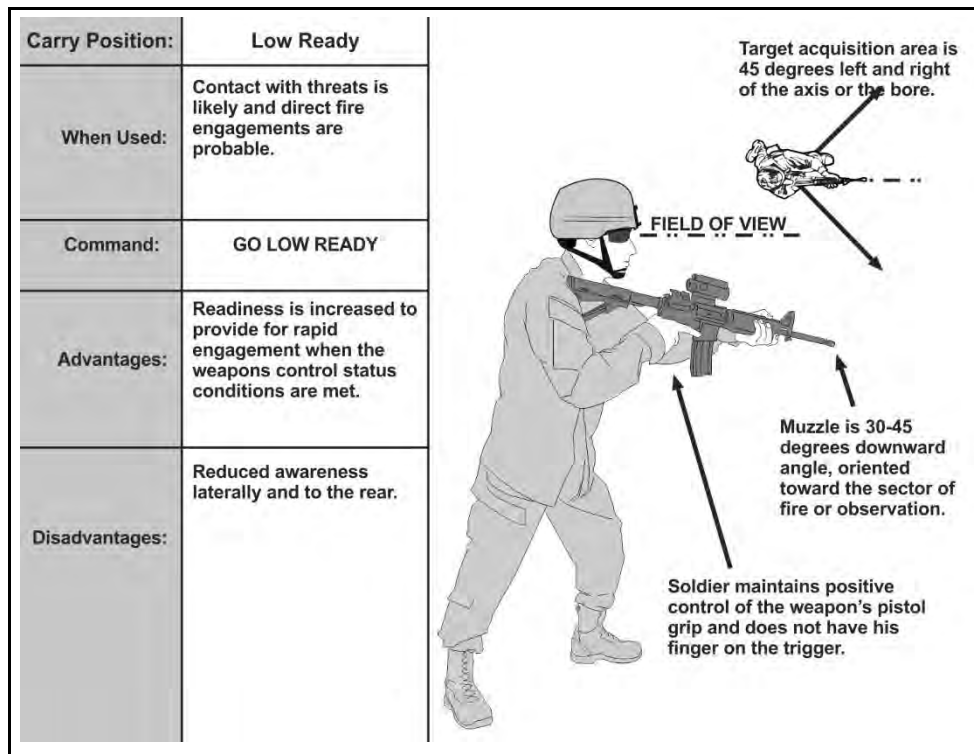

**Figure 6-5. Low ready position**

**HIGH READY**

6-22. The high ready is used when the Soldier’s sector of fire includes areas overhead or when an elevated muzzle orientation is appropriate for safety (see figure 6-6). The high ready carry is used when contact is likely.

6-23. In the high ready, the weapon is slung, butt stock is in the armpit, the muzzle angled up to at least a 45-degree angle and oriented toward the Soldier’s sector of fire—ensuring no other Soldiers are flagged.

6-24. The firing hand remains in the same position as the low ready. The non-firing side hand can be free as the weapon is supported by the firing side hand and armpit.

6-25. This position is not as effective as the low ready for several reasons: it impedes the field of view, flags friendlies above the sector of fire, and typically takes longer to acquire the target.

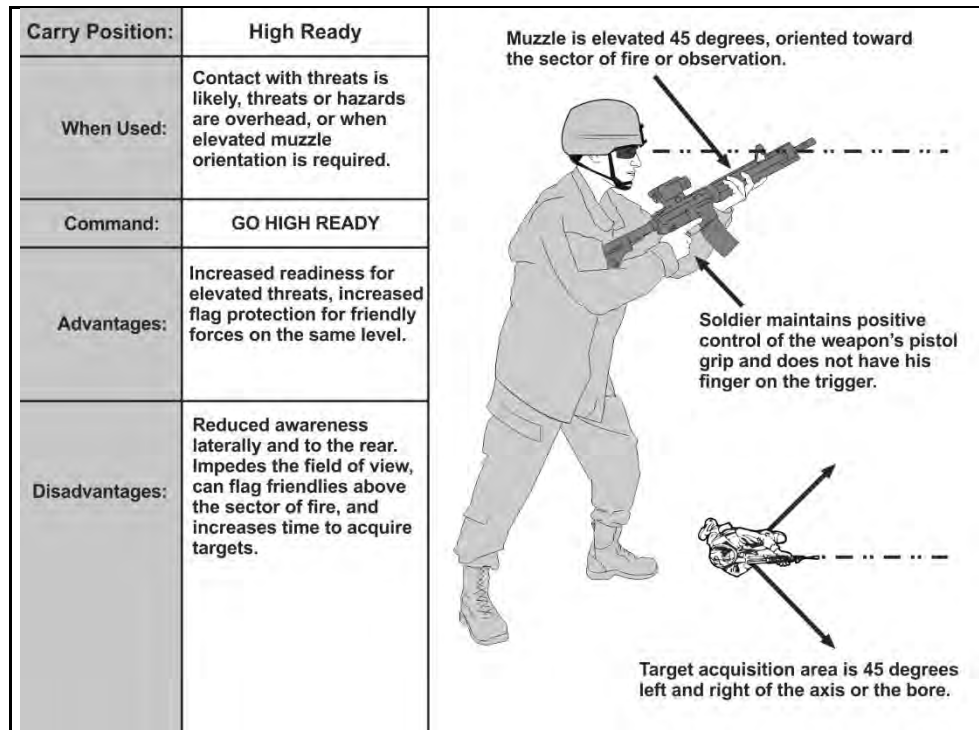

**Figure 6-6. High ready position**



**Chapter 6**

**READY OR READY-UP**

6-26. The ready is used when enemy contact is imminent (see figure 6-7). This carry is used when the Soldier is preparing or prepared to engage a threat.

6-27. In the ready, the weapon is slung, the toe of the butt stock is in the Soldier's shoulder, and muzzle is oriented toward a threat or most likely direction of enemy contact. The Soldier is looking through his optics or sights. His non-firing side hand remains on the hand guards or the vertical foregrip.

6-28. The firing hand remains on the pistol grip with the firing finger off the trigger until the decision to engage a target is made.

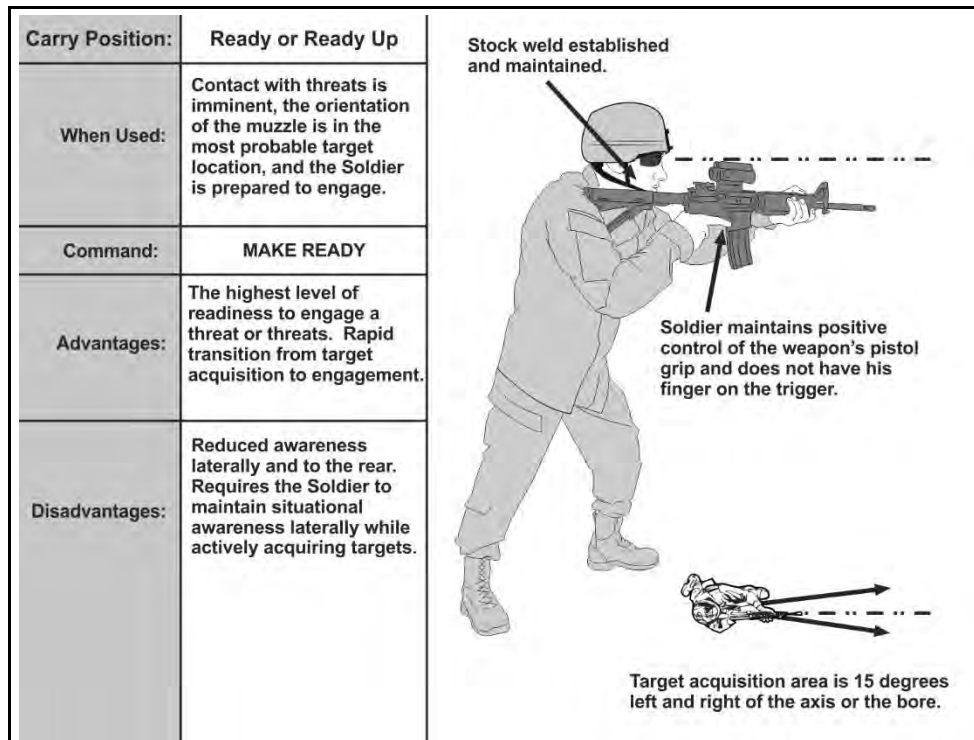

**Figure 6-7. Ready position or up position**

## STABILIZED FIRING

6-29. The Soldier must stabilize their weapon, whether firing from a stationary position or while on the move. To create a stabilized platform, Soldiers must understand the physical relationship between the weapon system, the shooter's body, the ground, and any other objects touching the weapon or shooter's body. The more contact the shooter has to the ground will determine how stable and effective the position is. The situation and tactics will determine the actual position used.

6-30. When a shooter assumes a stable firing position, movement from muscle tension, breathing, and other natural activities within the body will be transferred to the weapon and must be compensated for by the shooter.

6-31. Failing to create an effective platform to fire from is termed a *stabilization failure*. A stabilization failure occurs when a Soldier fails to:

- Control the movement of the barrel during the arc of movement
- Adequately support the weapon system
- Achieve their natural point of aim.

6-32. These failures compound the firing occasion's errors, which directly correlate to the accuracy of the shot taken. To maximize the Soldier's stability during the shot process, they correctly assume various firing positions when stationary, or offset the induced errors with other firing skills during tactical movement.

6-33. As a rule, positions that are lower to the ground provide a higher level of stability. When the center of gravity elevates the level of stability decreases as shown in figure°6-8.

Chapter 6

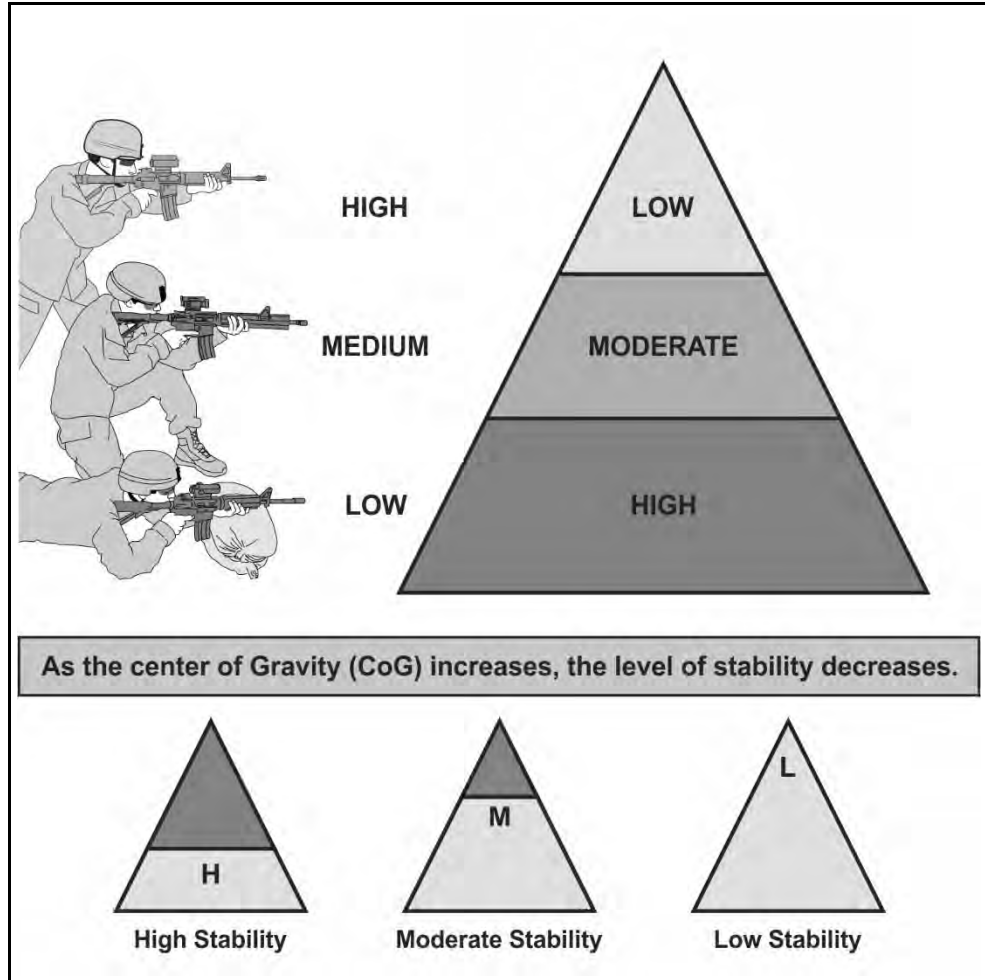

Figure 6-8. Firing position stability example

## FIRING POSITIONS

6-34. The nature of combat will not always allow time for a Soldier to get into a particular position. Soldiers need to practice firing in a variety of positions, including appropriate variations. There are 12 firing positions with variations that are common to all Soldiers. The positions are listed highest to lowest. The primary position is listed in bold, with the position variations in italics:

- **Standing** –
  - *Standing, unsupported.*
  - *Standing, supported.*
- **Squatting** – This position allows for rapid engagement of targets when an obstruction blocks the firer from using standard positions. It provides the firer a fairly well supported position by simply squatting down to engage, then returning to a standing position once the engagement is complete. The squatting position is generally unsupported.
- **Kneeling** – The kneeling position is very common and useful in most combat situations. The kneeling position can be supported or unsupported.
  - *Kneeling, unsupported.*
  - *Kneeling, supported.*
- **Sitting** – There are three types of sitting positions: crossed-ankle, crossed-leg, and open-leg. All positions are easy to assume, present a medium silhouette, provide some body contact with the ground, and form a stable firing position. These positions allow easy access to the sights for zeroing.
  - *Sitting, crossed ankle.*
  - *Sitting, crossed leg.*
  - *Sitting, open leg.*
- **Prone** – The prone position is the most stable firing position due to the amount of the Soldier's body is in contact with the ground. The majority of the firer's frame is behind the rifle to assist with recoil management.
  - *Prone, unsupported.*
  - *Prone, supported.*
  - *Prone, roll-over.*
  - *Prone, reverse roll-over.*

6-35. Soldiers must practice the positions dry frequently to establish their natural point of aim for each position, and develop an understanding of the restrictive nature of their equipment during execution. With each dry repetition, the Soldier's ability to change positions rapidly and correctly are developed, translating into efficient movement and consistent stable firing positions.

6-36. Each of these firing positions is described using in a standard format using the terms defined earlier.

**Chapter 6**

**STANDING, UNSUPPORTED**

6-37. This position should be used for closer targets or when time is not available to assume a steadier position such as short range employment. The upper body should be leaned slightly forward to aid in recoil management. The key focus areas for the standing supported position are applied as described in figure 6-9 below:

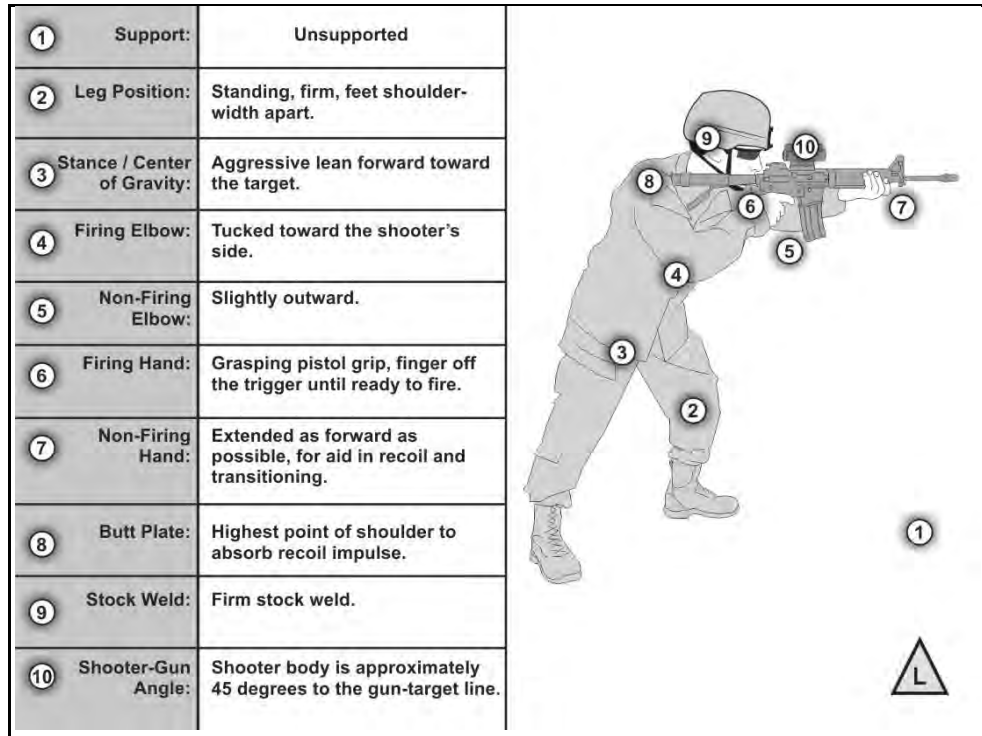
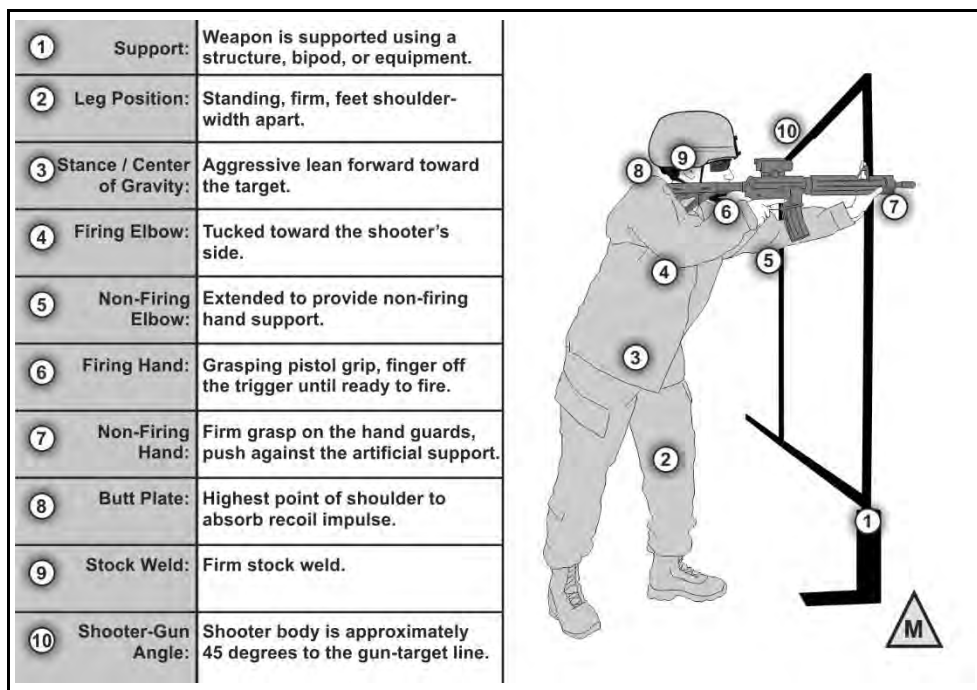

**Figure 6-9. Standing, unsupported example**

**STANDING, SUPPORTED**

6-38. Soldier should ensure it is the handguard of the weapon NOT the barrel that is in contact with the artificial support. Barrels being in direct contact with artificial support will result in erratic shots. The standing supported position uses artificial support to steady the position (see figure 6-10.) Forward pressure should be applied by the rear leg and upper body to aid in recoil management. The key focus area for the standing supported position are applied in the following ways:

**Nonfiring hand.** The nonfiring hand will hold the hand guards firmly and push against the artificial support. Hand positioning will vary depending on the type of support used.



**Figure 6-10. Standing, supported example**

**Chapter 6**

**SQUATTING**

6-39. This position allows for rapid engagement of targets when an obstruction blocks the firer from using standard positions. It allows the firer a fairly stable position by simply squatting down to engage, then returning to a standing position after completing the engagement (see figure 6-11.)

6-40. Perform the following to assume a good squatting firing position:

- Face the target.
- Place the feet shoulder-width apart.
- Squat down as far as possible.
- Place the back of triceps on the knees ensuring there is no bone on bone contact.
- Place the firing hand on the pistol grip and the nonfiring hand on the upper hand guards.
- Place the weapon's butt stock high in the firer's shoulder pocket.

*Note.* The firer may opt to use pressure from firing hand to rotate weapon to place the magazine against the opposite forearm to aid in stabilization.

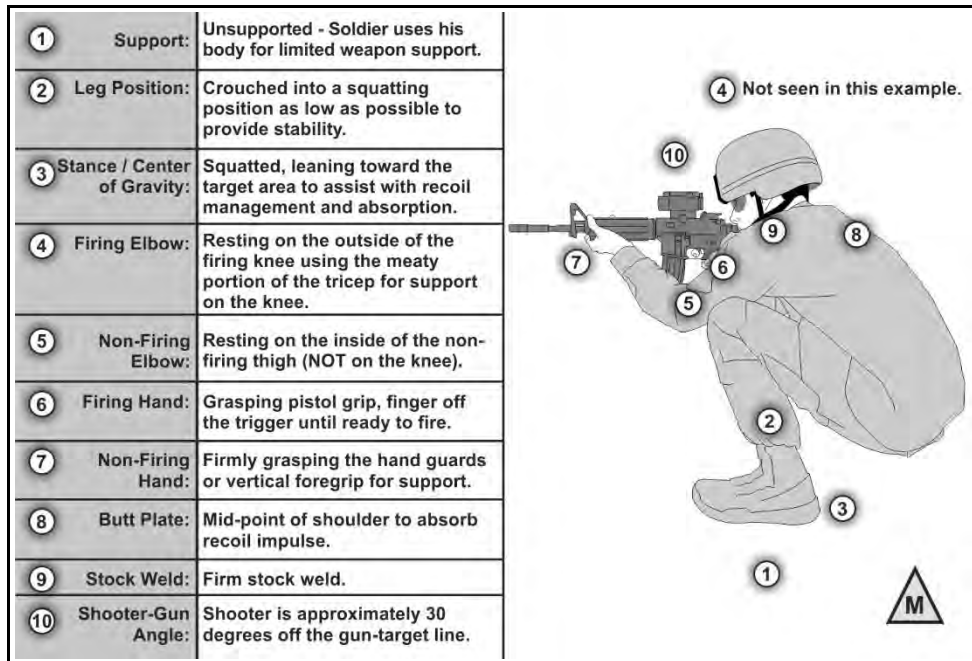

**Figure 6-11. Squatting position**

**KNEELING, UNSUPPORTED**

6-41. The kneeling unsupported position does not use artificial support. Figure 6-12 shows the optimum unsupported kneeling position. The firer should be leaning slightly forward into the position to allow for recoil management and quicker follow-up shots. The primary goal of this firing position is to establish the smallest wobble area possible. Key focus areas for kneeling, unsupported are:

- **Nonfiring elbow.** Place the non-firing elbow directly underneath the rifle as much as possible. The elbow should be placed either in front of or behind the kneecap. Placing the elbow directly on the kneecap will cause it to roll and increases the wobble area.
- **Leg position.** The non-firing leg should be bent approximately 90 degrees at the knee and be directly under the rifle. The firing-side leg should be perpendicular to the nonfiring leg. The firer may rest their body weight on the heel. Some firers lack the flexibility to do this and may have a gap between their buttocks and the heel.
- **Aggressive (stretch) kneeling.** All weight on non-firing foot, thigh to calf, upper body leaning forward, nonfiring triceps on non-firing knee, firing leg stretched behind for support. Highly effective for rapid fire and movement.

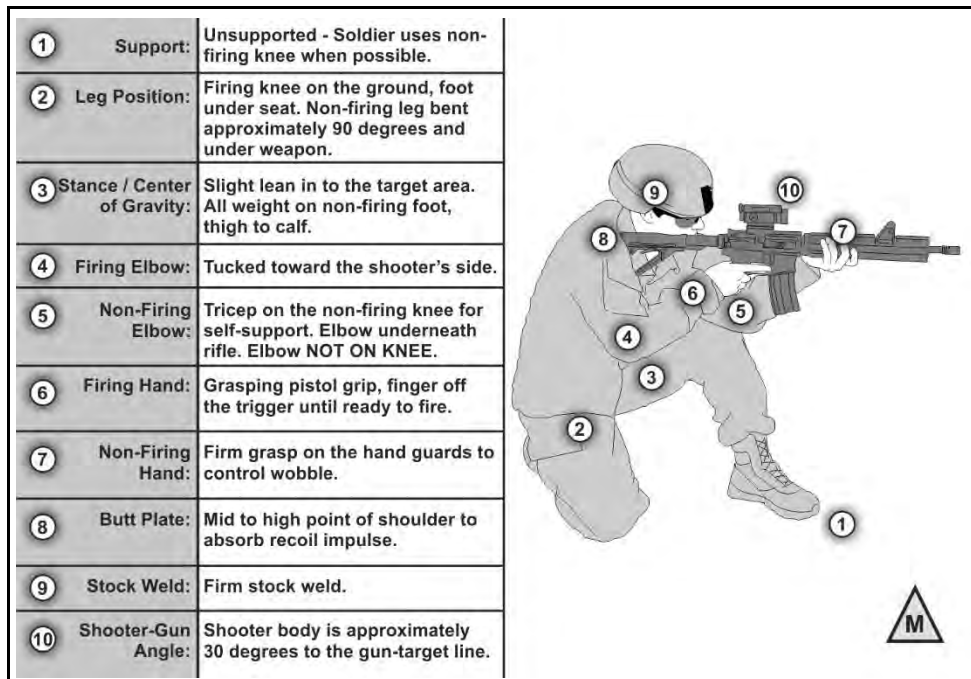

Figure 6-12. Kneeling, unsupported example



**Chapter 6**

**KNEELING, SUPPORTED**

6-42. The kneeling supported position uses artificial support to steady the position (see figure 6-13). Contact by the nonfiring hand and elbow with the artificial support is the primary difference between the kneeling supported and unsupported positions since it assists in the stability of the weapon. Body contact is good, but the barrel of the rifle must not touch the artificial support. Forward pressure is applied to aid in recoil management. The key focus areas for the kneeling supported position are applied in the following ways:

- **Nonfiring hand.** The nonfiring hand will hold the hand guards firmly and will also be pushed against the artificial support. Hand positioning will vary depending on the type of support used.
- **Nonfiring elbow.** The nonfiring elbow and forearm may be used to assist with the weapon's stability by pushing against the artificial support. The contact of the nonfiring elbow and forearm with the structure will vary depending on the support used and the angle to the target.

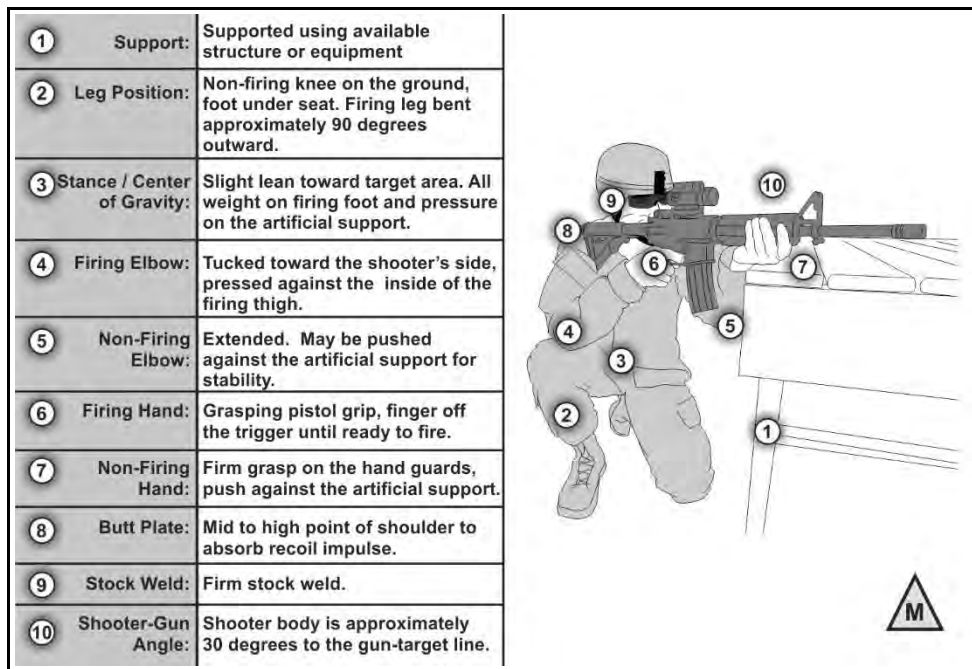

**Figure 6-13. Kneeling, supported example**

**Stability**

**SITTING, CROSSED-ANKLE**

6-43. The sitting, crossed-ankle position provides a broad base of support and places most of the body weight behind the weapon (see figure 6-14). This allows quick shot recovery and recoil impulse absorption. Perform the following to assume a good crossed-ankle position:

- Face the target at a 10- to 30-degree angle.
- Place the nonfiring hand under the hand guard.
- Bend at knees and break fall with the firing hand.
- Push backward with feet to extend legs and place the buttocks to ground.
- Cross the non-firing ankle over the firing ankle.
- Bend forward at the waist.
- Place the non-firing elbow on the nonfiring leg below knee.
- Grasp the rifle butt with the firing hand and place into the firing shoulder pocket.
- Grasp the pistol grip with the firing hand.
- Lower the firing elbow to the inside of the firing knee.
- Place the cheek firmly against the stock to obtain a firm stock weld.
- Move the nonfiring hand to a location under the hand guard that provides the maximum bone support and stability for the weapon.

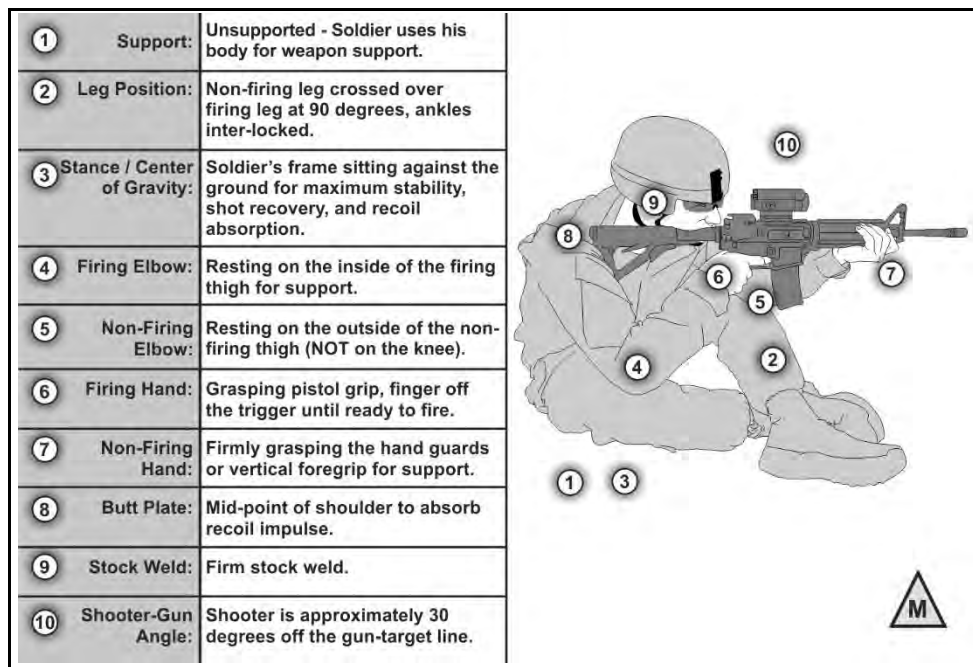

**Figure 6-14. Sitting position—crossed ankle**

**Chapter 6**

**SITTING, CROSSED-LEG**

6-44. The crossed-leg sitting position provides a base of support and places most of the body weight behind the weapon for quick shot recovery (see figure 6-15). Soldiers may experience a strong pulse beat in this position due to restricted blood flow in the legs and abdomen. An increased pulse causes a larger wobble area.

6-45. Perform the following to assume a good crossed-leg position:

- Place the nonfiring hand under the hand guard.
- Cross the nonfiring leg over the firing leg.
- Bend at the knees and break the fall with the firing hand.
- Place the buttocks to the ground close to the crossed legs.
- Bend forward at the waist.
- Place the nonfiring elbow on the nonfiring leg at the bend of the knee.
- Establish solid butt stock position in the firing shoulder pocket.
- Grasp the pistol grip with the firing hand.
- Lower the firing elbow to the inside of the firing knee.
- Place the cheek firmly against the stock to obtain a firm stock weld.
- Place the non-firing hand under the hand guard to provide support.

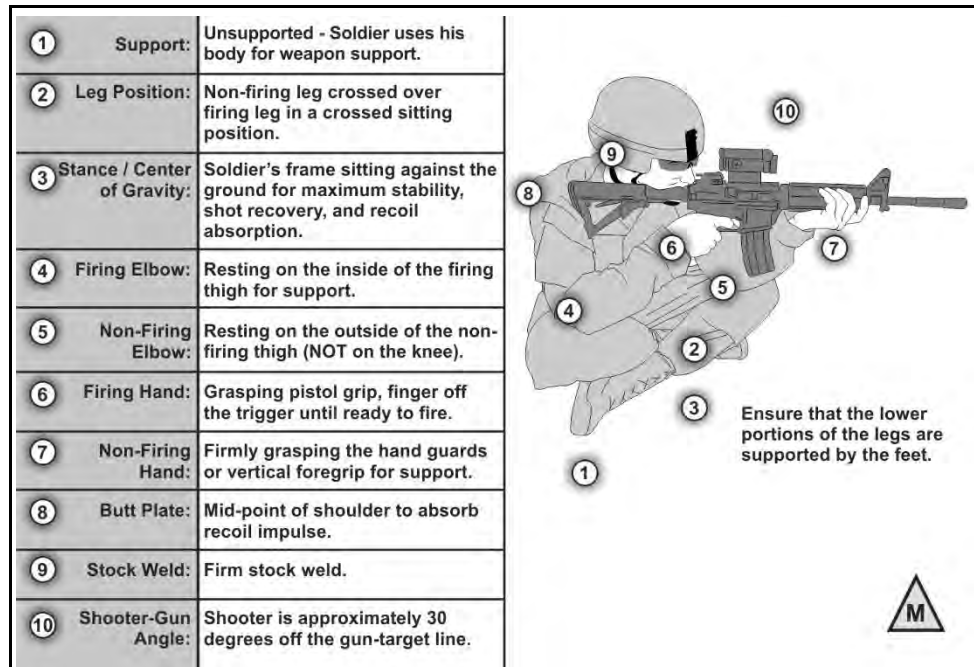

**Figure 6-15. Sitting position—crossed-leg**

**Stability**

**SITTING, OPEN-LEG**

6-46. The open-leg sitting position is the preferred sitting position when shooting with combat equipment (see figure 6-16). It places less of the body weight behind the weapon than the other sitting positions. Perform the following to assume a good open-leg position:

- Face the target at a 10 to 30 degree angle to the firing of the line of fire.
- Place the feet approximately shoulder width apart.
- Place the nonfiring hand under the hand guard.
- Bend at the knees while breaking the fall with the firing hand. Push backward with the feet to extend the legs and place the buttocks on ground.
- Place the both the firing and non-firing elbow inside the knees.
- Grasp the rifle butt with the firing hand and place into the firing shoulder pocket.
- Grasp the pistol grip with the firing hand.
- Lower the firing elbow to the inside of the firing knee.
- Place the cheek firmly against the stock to obtain a firm stock weld.
- Move nonfiring hand to a location under the hand guard that provides maximum bone support and stability for the weapon.

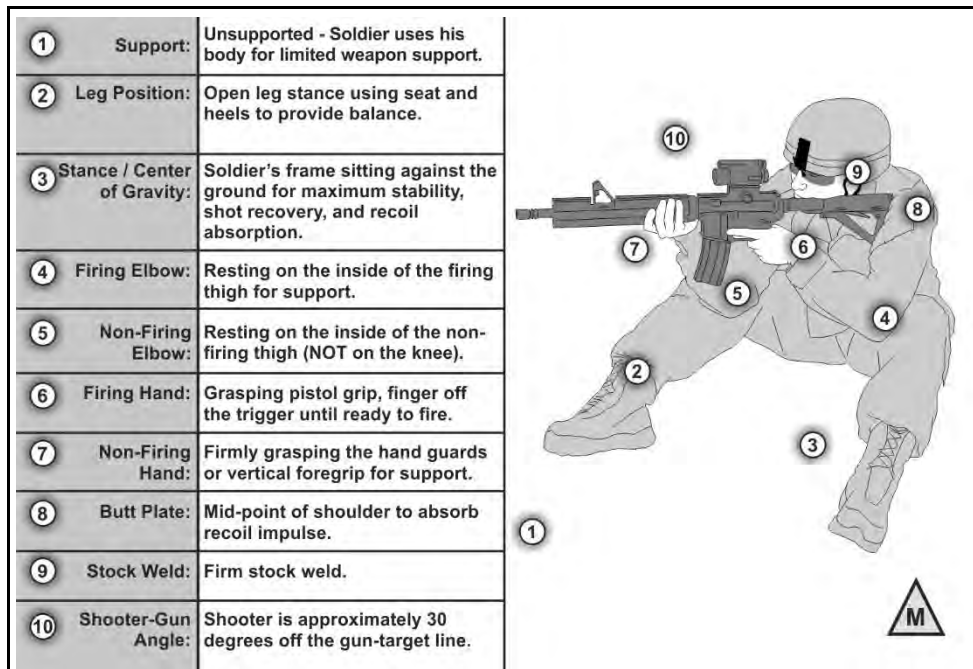

**Figure 6-16. Sitting position—open leg**

**Chapter 6**

**PRONE, UNSUPPORTED**

6-47. The prone unsupported position is not as stable as the prone supported position (see figure 6-17). Soldiers must build a stable, consistent position that focuses on the following key areas:

- **Firing hand.** The firer should have a firm handshake grip on the pistol grip and place their finger on the trigger where it naturally falls.
- **Nonfiring hand.** The nonfiring hand is placed to control the weapon and is comfortable.
- **Leg position.** The firer’s legs may be either spread with heels as flat as possible on ground or the firing side leg may be bent at the knee to relieve pressure on the stomach.

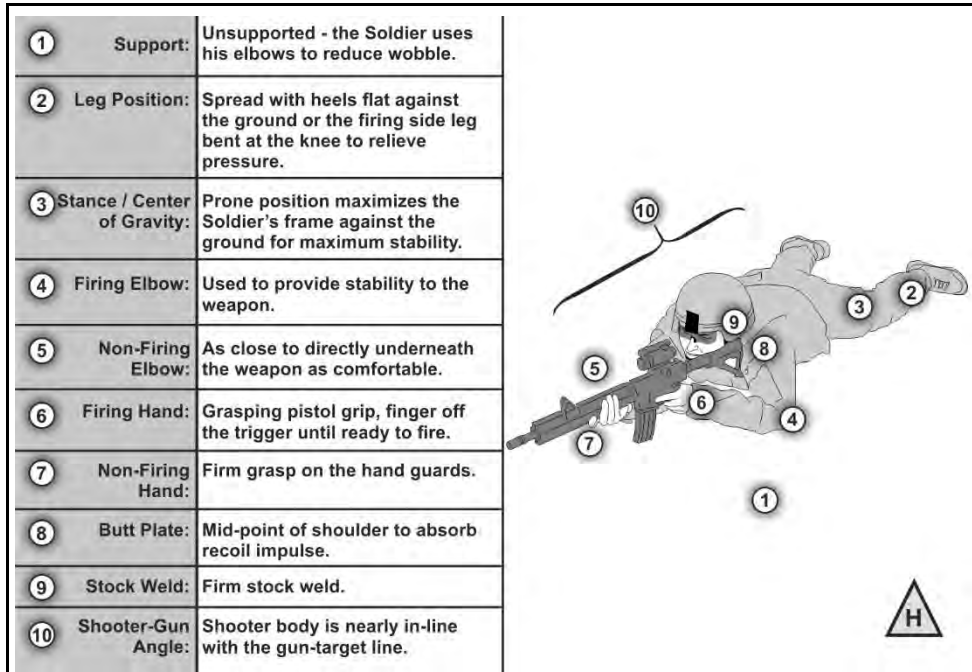

**Figure 6-17. Prone, unsupported example**

*Note.* The magazine can be rested on the ground while using the prone unsupported position. Firing with the magazine on the ground will NOT induce a malfunction.

**Stability**

**PRONE, SUPPORTED**

6-48. The prone supported position allows for the use of support, such as sandbags (see figure 6-18). Soldiers must build a stable, consistent position that focuses on the following key areas:

- **Firing hand.** The firer should have a firm handshake grip on the pistol grip and place their finger on the trigger where it naturally falls.
- **Nonfiring hand.** The nonfiring hand is placed to maximize control the weapon and where it is comfortable on the artificial support.
- **Leg position.** The firer's legs may be either spread with heels as flat as possible on ground or the firing side leg may be bent at the knee to relieve pressure on the stomach.
- **Artificial support.** The artificial support should be at a height that allows for stability without interfering with the other elements of the position.

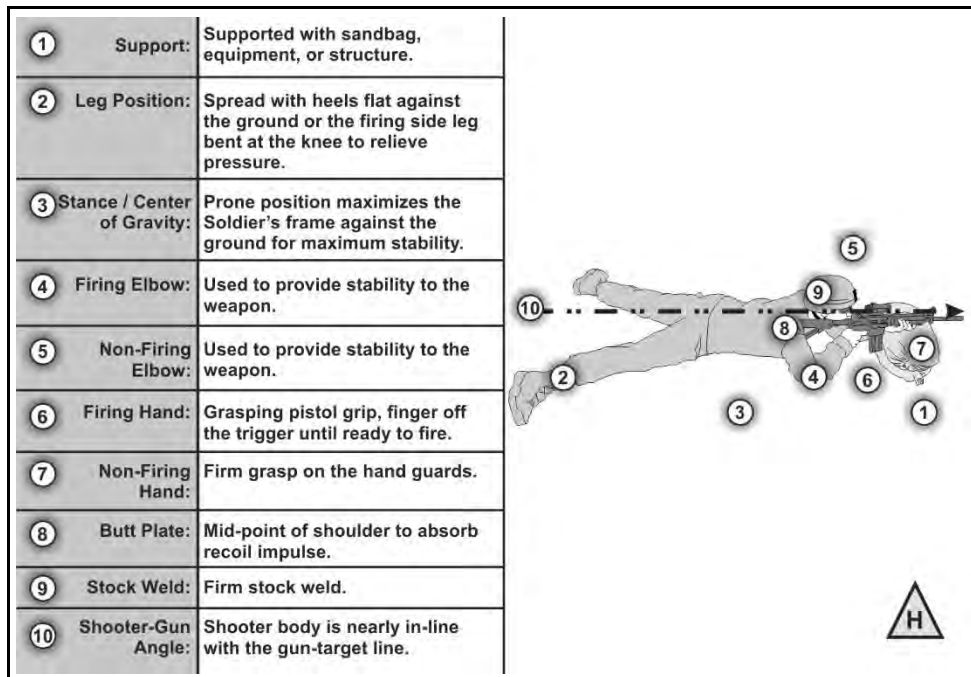

**Figure 6-18. Prone, supported example**

**Chapter 6**

**PRONE, ROLL-OVER**

6-49. This position allows the firer to shoot under obstacles or cover that would not normally be attainable from the standard conventional prone position (see figure 6-19). With this position, the bullet trajectory will be off compared to the line of sight and increase with distance from the firer.

For example, in the figure below the sights are rotated to the right. The trajectory of the bullet will be lower than and to the right of point of aim. This error will increase with range.

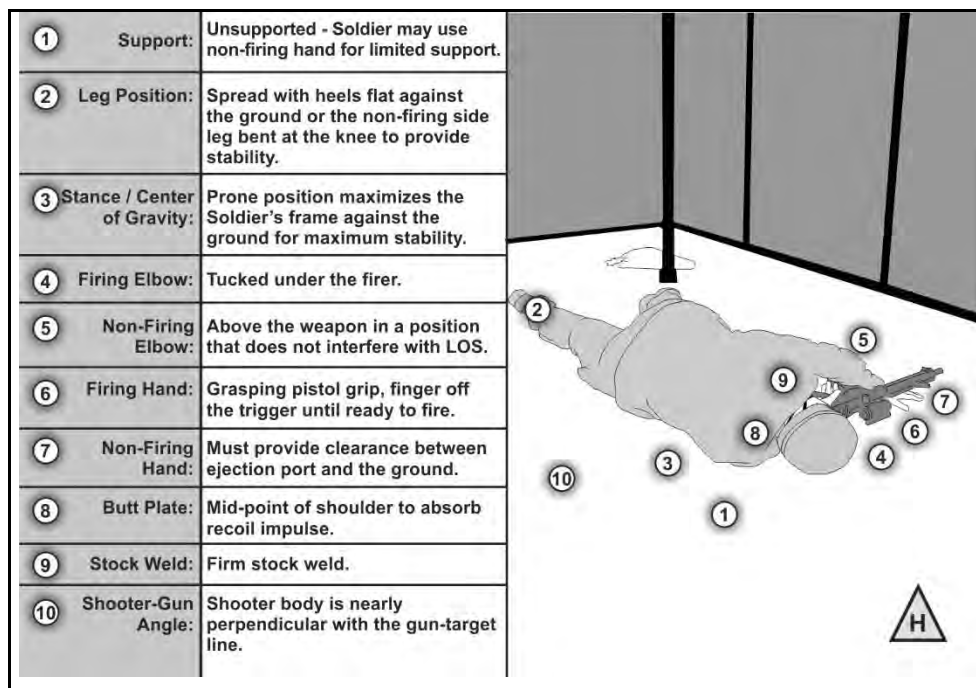

**Figure 6-19. Prone, roll-over example**

**Stability**

**PRONE, REVERSE ROLL-OVER**

6-50. This position is primarily used when the firer needs to keep behind cover that is too low to use while in a traditional prone position (see figure 6-20). The bullet's trajectory will be off considerably at long distances while in this position.

6-51. This position is the most effective way to support the weapon when the traditional prone is too low to be effective and where a kneeling position is too high to gain cover or a solid base for support.

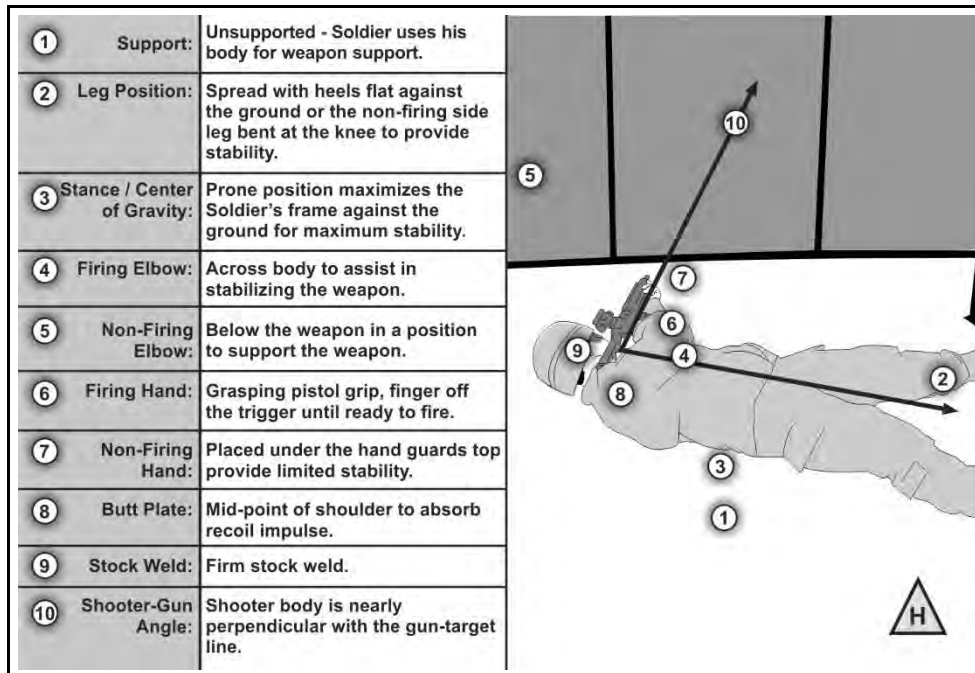

**Figure 6-20. Reverse roll-over prone firing position**



This page intentionally left blank.

## Chapter 7

# Aim

The functional element aim of the shot process is the continuous process of orienting the weapon correctly, aligning the sights, aligning on the target, and the application of the appropriate lead and elevation during a target engagement. Aiming is a continuous process conducted through pre-shot, shot, and post-shot, to effectively apply lethal fires in a responsible manner with accuracy and precision.

Aiming is the application of perfectly aligned sights on a specific part of a target. Sight alignment is the first and most important part of this process.

## COMMON ENGAGEMENTS

7-1. The aiming process for engaging stationary targets consist of the following Soldier actions, regardless of the optic, sight, or magnification used by the aiming device:

- **Weapon orientation** – the direction of the weapon as it is held in a stabilized manner.
- **Sight alignment** – the physical alignment of the aiming device:
  - Iron sight/back-up iron sight and the front sight post.
  - Optic reticle.
  - Ballistic reticle (day or thermal).
- **Sight picture** – the target as viewed through the line of sight.
- **Point of aim (POA)** – the specific location where the line of sight intersects the target.
- **Desired point of impact (POI)**–the desired location of the strike of the round to achieve the desired outcome (incapacitation or lethal strike).

7-2. The aim of the weapon is typically applied to the largest, most lethal area of any target presented. Sights can be placed on target by using battlesight zero (BZ), **center of visible mass (CoVM)**. The center of visible mass is the initial point of aim on a target of what can be seen by the Soldier. It does not include what the target size is expected or anticipated to be. For example, a target located behind a car exposes its head. The center of visible mass is in the center of the head, not the estimated location of the center of the overall target behind the car.

**Chapter 7**

---

**WEAPON ORIENTATION**

7-3. The Soldier orients the weapon in the direction of the detected threat. Weapon orientation includes both the horizontal plane (azimuth) and the vertical plane (elevation). Weapon orientation is complete once the sight and threat are in the Soldier's field of view.

- **Horizontal weapons orientation** covers the frontal arc of the Soldier, spanning the area from the left shoulder, across the Soldier's front, to the area across the right shoulder (see figure 7-1).

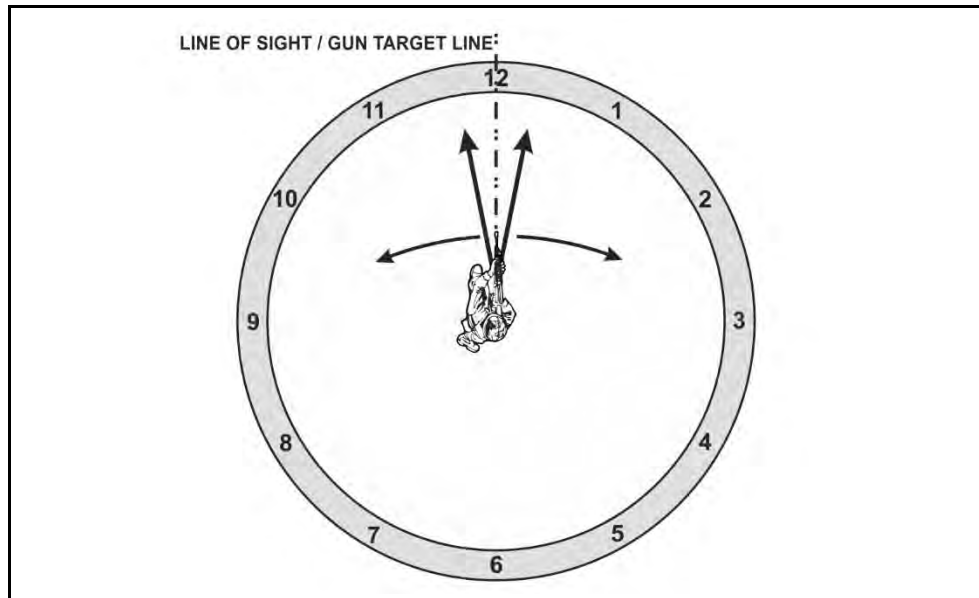

**Figure 7-1. Horizontal weapon orientation example**

**Aim**

- **Vertical weapons orientation** includes all the aspects of orienting the weapon at a potential or confirmed threat in elevation. This is most commonly applied in restricted, mountainous, or urban terrain where threats present themselves in elevated or depressed firing positions (see figure 7-2).

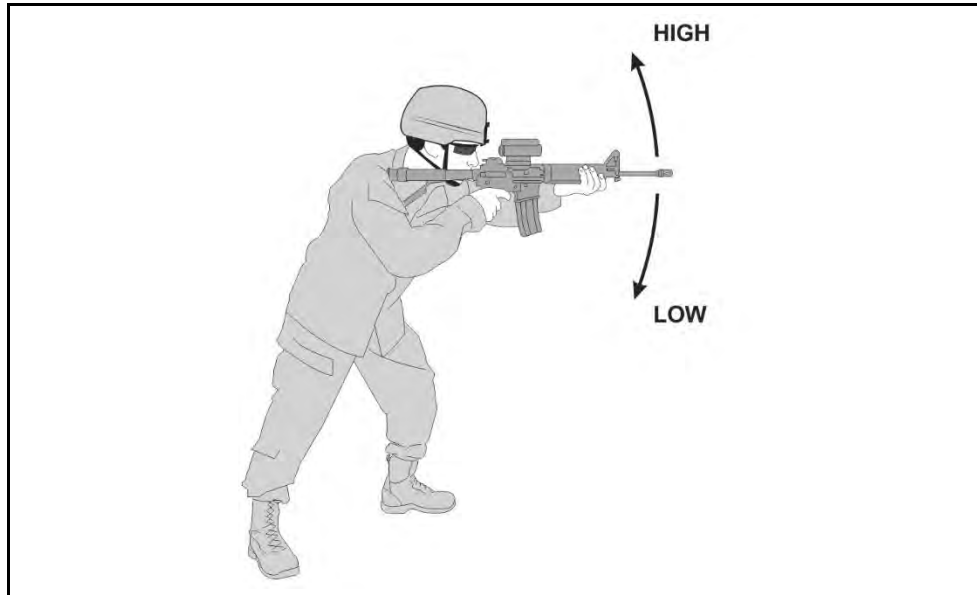

**Figure 7-2. Vertical weapons orientation example**

**SIGHT ALIGNMENT**

7-4. Sight alignment is the relationship between the aiming device and the firer's eye. The process used by a Soldier depends on the aiming device employed with the weapon.

- **Iron sight** – the relationship between the front sight post, rear sight aperture, and the firer's eye. The firer aligns the tip of the front sight post in the center of the rear aperture and his/or her eye. The firer will maintain focus on the front sight post, simultaneously centering it in the rear aperture.
- **Optics** – the relationship between the reticle and the firer's eye and includes the appropriate eye relief, or distance of the Soldier's eye from the optic itself. Ensure the red dot is visible in the CCO, or a full centered field of view is achieved with no shadow on magnified optics
- **Thermal** – the relationship between the firer's eye, the eyepiece, and the reticle.
- **Pointers / Illuminators / Lasers** – the relationship between the firer's eye, the night vision device placement and focus, and the laser aiming point on the target.

**Chapter 7**

*Note.* Small changes matter - 1/1000 of an inch deviation at the weapon can result in up to an 18 inch deviation at 300 meters.

7-5. The human eye can only focus clearly on one object at a time. To achieve proper and effective aim, the focus of the firer's eye needs to be on the front sight post or reticle (see figure 7-3). This provides the most accurate sight alignment for the shot process.

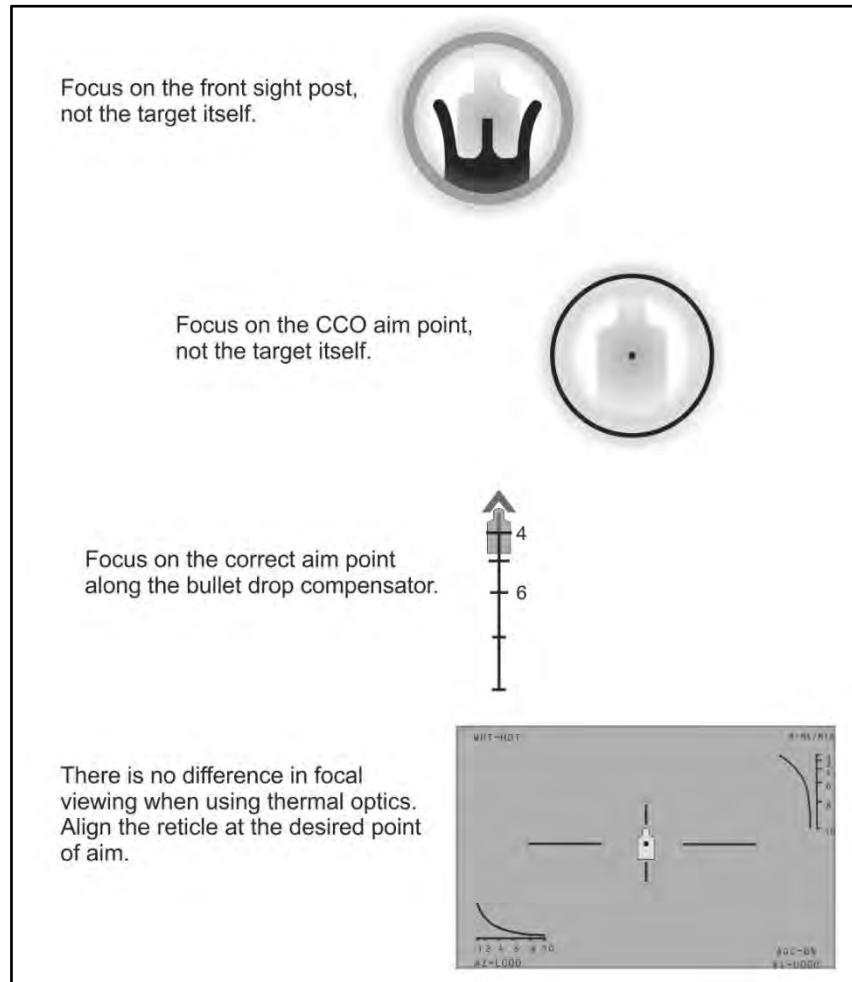

**Figure 7-3. Front sight post/reticle aim focus**

7-6. Firers achieve consistent sight alignment by resting the full weight of their head on the stock in a manner that allows their dominant eye to look through the center of the aiming or sighting device. If the firer's head placement is subjected to change during the firing process or between shots, the Soldier will experience difficulty achieving accurate shot groups.

## SIGHT PICTURE

7-7. The sight picture is the placement of the aligned sights on the target itself. The Soldier must maintain sight alignment throughout the positioning of the sights. This is not the same as sight alignment.

7-8. There are two sight pictures used during the shot process; pre-shot and post-shot. Soldiers must remember the sight pictures of the shot to complete the overall shot process.

- Pre-shot sight picture – encompasses the original point of aim, sight picture, and any holds for target or environmental conditions.
- Post-shot sight picture – is what the Soldier must use as the point of reference for any sight adjustments for any subsequent shot.

## POINT OF AIM

7-9. The point on the target that is the continuation of the line created by sight alignment. The point of aim is a point of reference used to calculate any hold the Soldier deems necessary to achieve the desired results of the round's impact.

7-10. For engagements against stationary targets, under 300 meters, with negligible wind, and a weapon that has a 200 meter or 300 meter confirmed zero, the point of aim should be the center of visible mass of the target. The point of aim does not include ANY hold-off or lead changes necessary.

## DESIRED POINT OF IMPACT

7-11. The desired point of impact is the location where the Soldier wants the projectile to strike the target. Typically, this is the center of visible mass. At any range different from the weapon's zero distance, the Soldier's desired point of impact and their point of aim will not align. This requires the Soldier to determine the necessary hold-off to achieve the desired point of impact.

## COMMON AIMING ERRORS

7-12. Orienting and aiming a weapon correctly is a practiced skill. Through drills and repetitions, Soldiers build the ability to repeat proper weapons orientation, sight alignment, and sight picture as a function of muscle memory.

7-13. The most common aiming errors include:

- **Non-dominant eye use** – The Soldier gets the greatest amount of visual input from their dominant eye. Eye dominance varies Soldier to Soldier. Some Soldier's dominant eye will be the opposite of the dominant hand. For example, a Soldier who writes with his right hand and learns to shoot rifles right handed might learn that his dominant eye is the left eye. This is called cross-dominant. Soldiers with strong cross-dominant eyes should consider firing using their dominant eye side while firing from their non-dominant hand side. Soldiers can be trained to fire from either side of the weapon, but may not be able to shoot effectively using their nondominant eye.

## Chapter 7

---

- **Incorrect zero** – regardless of how well a Soldier aims, if the zero is incorrect, the round will not travel to the desired point of impact without adjustment with subsequent rounds (see appendix C of this publication).
- **Light conditions** – limited visibility conditions contribute to errors aligning the sight, selecting the correct point of aim, or determining the appropriate hold. Soldiers may offset the effects of low light engagements with image intensifier (I2) optics, use of thermal optics, or the use of laser pointing devices with I2 optics.
- **Battlefield obscurants** – smoke, debris, and haze are common conditions on the battlefield that will disrupt the Soldier's ability to correctly align their sights, select the proper point of aim, or determine the correct hold for a specific target.
- **Incorrect sight alignment** – Soldiers may experience this error when failing to focus on the front sight post or reticle.
- **Incorrect sight picture** – occurs typically when the threat is in a concealed location, is moving, or sufficient winds between the shooter and target exist that are not accounted for during the hold determination process. This failure directly impacts the Soldier's ability to create and sustain the proper sight picture during the shot process.
- **Improper range determination** – will result in an improper hold at ranges greater than the zeroed range for the weapon.

## COMPLEX ENGAGEMENTS

7-14. A complex engagement includes any shot that cannot use the *CoVM* as the point of aim to ensure a target hit. Complex engagements require a Soldier to apply various points of aim to successfully defeat the threat.

7-15. These engagements have an increased level of difficulty due to environmental, target, or shooter conditions that create a need for the firer to rapidly determine a ballistic solution and apply that solution to the point of aim. Increased engagement difficulty is typically characterized by one or more of the following conditions:

- **Target conditions:**
  - Range to target.
  - Moving targets.
  - Oblique targets.
  - Evasive targets.
  - Limited exposure targets.
- **Environmental conditions:**
  - Wind.
  - Angled firing.
  - Limited visibility.
- **Shooter conditions:**
  - Moving firing position.

---

**Aim**

- Canted weapon engagements.
- CBRN operations engagements.

7-16. Each of these firing conditions may require the Soldier to determine an appropriate aim point that is not the CoVM. This Soldier calculated aim point is called the **hold**. During any complex engagement, the Soldier serves as the ballistic computer during the shot process. The hold represents a refinement or alteration of the center of visible mass point of aim at the target to counteract certain conditions during a complex engagement for—

- Range to target.
- Lead for targets based on their direction and speed of movement.
- Counter-rotation lead required when the Soldier is moving in the opposite direction of the moving target.
- Wind speed, direction, and duration between the shooter and the target at ranges greater than 300 meters.
- Greatest lethal zone presented by the target to provide the most probable point of impact to achieve immediate incapacitation.

7-17. The Soldier will apply the appropriate aim (hold) based on the firing instances presented. Hold determinations will be discussed in two formats; immediate and deliberate.

7-18. All Soldiers must be familiar with the immediate hold determination methods. They should be naturally applied when the engagement conditions require. These determinations are provided in “target form” measurements, based on a standard E-type silhouette dimension, approximately 20 inches wide by 40 inches tall.

### **IMMEDIATE HOLD DETERMINATION**

7-19. Immediate holds are based on the values of a “target form,” where the increments shown *are sufficient* for rapid target hits without ballistic computations. The immediate hold determinations are not as accurate as the deliberate method, and are used for complex target engagements at less than 300 meters.

7-20. Immediate hold locations for azimuth (wind or lead): (See figure 7-4.)



**Chapter 7**

---

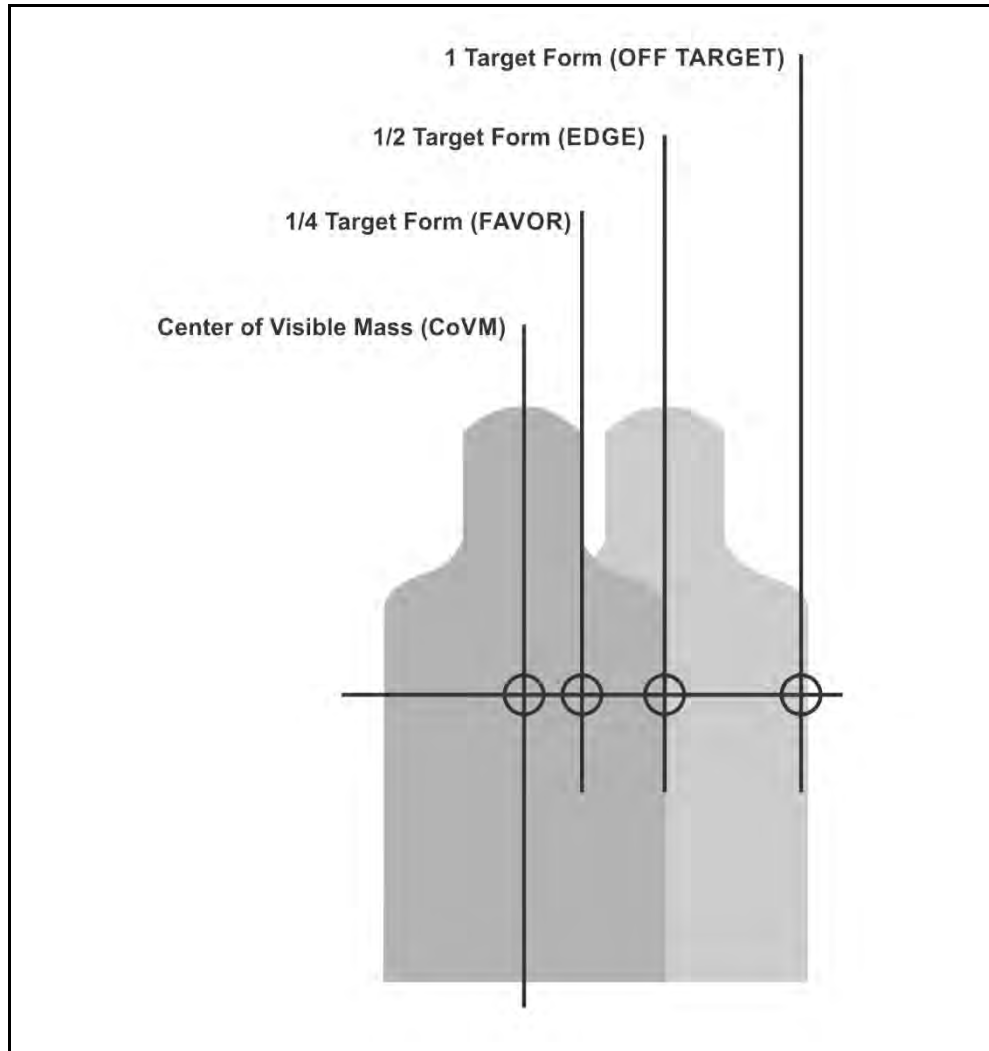

**Figure 7-4. Immediate hold locations for windage and lead example**

7-21. Immediate hold locations for elevation (range to target): (See figure 7-5.)

Aim

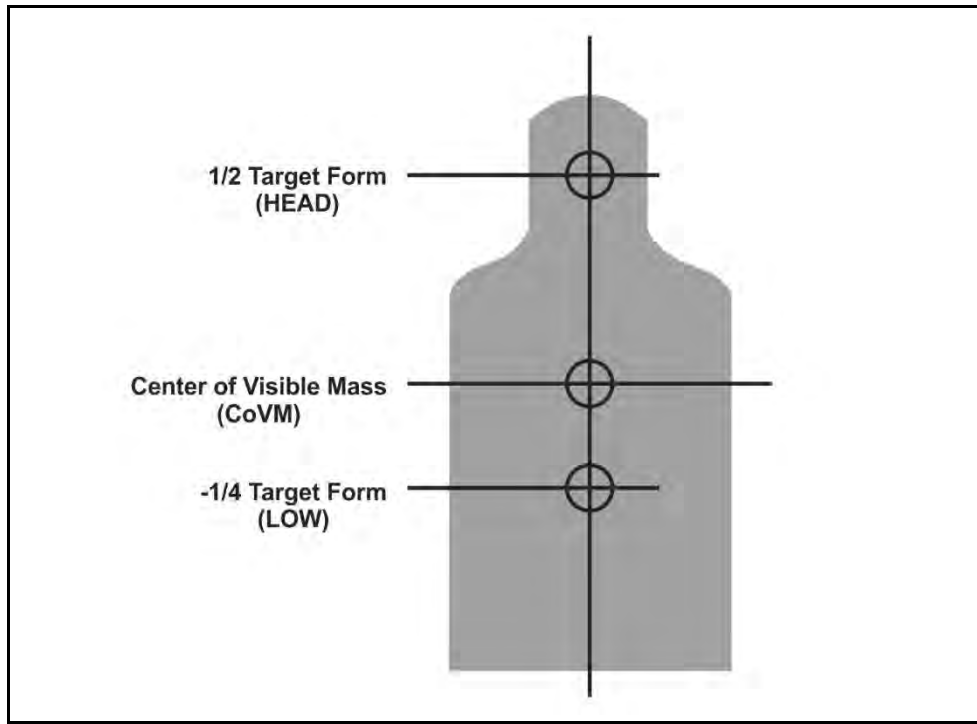

**Figure 7-5. Immediate hold locations for elevation (range) example**

**DELIBERATE HOLD DETERMINATION**

7-22. Deliberate hold points of aim are derived from applying the appropriate ballistic math computation. Deliberate hold determinations are required for precise shots beyond 300 meters for wind, extended range, moving, oblique, or evasive targets.

7-23. Deliberate holds for complex engagements are discussed in detail in appendix C, Complex Engagements. The deliberate math calculations are for advanced shooters within the formation and are not discussed within this chapter.

## Chapter 7

---

### TARGET CONDITIONS

7-24. Soldiers must consider several aspects of the target to apply the proper point of aim on the target. The target's posture, or how it is presenting itself to the shooter, consists of—

- Range to target.
- Nature of the target.
- Nature of the terrain (surrounding the target).

### RANGE TO TARGET

7-25. Rapidly determining an accurate range to target is critical to the success of the Soldier at mid and extended ranges. There are several range determination methods shooters should be confident in applying to determine the proper hold-off for pending engagements. There are two types of range determination methods, immediate and deliberate.

#### Immediate Range Determination

7-26. Immediate methods of range determination afford the shooter the most reliable means of determining the most accurate range to a given target. The immediate methods include—

- Close quarters engagements.
- Laser range finder.
- Front sight post method.
- Recognition method.
- 100-meter unit-of-measure method.

#### *Close Quarters Engagements*

7-27. Short-range engagements are probable in close terrain (such as urban or jungle) with engagement ranges typically less than 50 meters. Soldiers must be confident in their equipment, zero, and capabilities to defeat the threats encountered.

7-28. Employment skills include swift presentation and application of the shot process (such as quick acquisition of sight picture) to maintain overmatch. At close ranges, perfect sight alignment is not as critical to the accurate engagement of targets. The weapon is presented rapidly and the shot is fired with the front sight post placed roughly center mass on the desired target area. The front sight post must be in the rear sight aperture.

---

**Note.** If using iron sights when this type of engagement is anticipated, the large rear sight aperture (0-2) should be used to provide a wider field of view and detection of targets.

---

***Laser Range Finder***

7-29. Equipment like the AN/PSQ-23, STORM have an on-board laser range finder that is accurate to within +/- 5 meters. Soldiers with the STORM attached can rapidly determine the most accurate range to target and apply the necessary hold-offs to ensure the highest probability of incapacitation, particularly at extended ranges.

***Front Sight Post Method***

7-30. The area of the target that is covered by the front sight post of the rifle can be used to estimate range to the target. By comparing the appearance of the rifle front sight post on a target at known distances, your shooters can establish a mental reference point for determining range at unknown distances. Because the apparent size of the target changes as the distance to the target changes, the amount of the target that is covered by the front sight post will vary depending upon its range. In addition, your shooter's eye relief and perception of the front sight post will also affect the amount of the target that is visible (see figure 7-6).

- Less Than 300 Meters. If the target is wider than the front sight post, you can assume that the target is less than 300 meters and can be engaged point of aim/point of impact using your battle sight zero (BZO).
- Greater Than 300 Meters. The service rifle front sight post covers the width of a man's chest or body at approximately 300 meters. If the target is less than the width of the front sight post, you should assume the target is in excess of 300 meters. Therefore, your BZO cannot be used effectively.



**Figure 7-6. Front sight post method example**

***Recognition Method***

7-31. When observing a target, the amount of detail seen at various ranges gives the shooter a solid indication of the range to target. Shooters should study and remember the appearance of a person when they are standing at 100 meters increments. During

## Chapter 7

---

training, Soldiers should note the details of size and the characteristics of uniform and equipment for targets at those increments.

7-32. Once Soldiers are familiar and memorize the characteristics of standing threats at 100 meter increments out to 500 meters, they should study the targets in a kneeling and then in the prone position. By comparing the appearance of these positions at known ranges from 100 meters to 500 meters, shooters can establish a series of mental images that will help determine range on unfamiliar terrain. They should also study the appearance of other familiar objects such as weapons and vehicles.

- **100 meters** – the target can be clearly observed in detail, and facial features can be distinguished.
- **200 meters** – the target can be clearly observed, although there is a loss of facial detail. The color of the skin and equipment is still identifiable.
- **300 meters** – the target has a clear body outline, face color usually remains accurate, but remaining details are blurred.
- **400 meters** – the body outline is clear, but remaining detail is blurred.
- **500 meters** – the body shape begins to taper at the ends. The head becomes indistinct from the shoulders.

### *100-meter Unit-of-Measure Method*

7-33. To determine the total distance to the target using the 100 meter unit of measure method, shooters must visualize a distance of 100 meters (generally visualizing the length of a football field) on the ground. Soldiers then estimate how many of these units can fit between the shooter and the target.

7-34. The greatest limitation of the unit of measure method is that its accuracy is directly related to how much of the terrain is visible. This is particularly true at greater ranges. If a target appears at a range of 500 meters or more and only a portion of the ground between your shooter and the target can be seen, it becomes difficult to use the unit of measure method of range estimation with accuracy.

7-35. Proficiency in the unit of measure method requires constant practice. Throughout training, comparisons should be continually made between the range estimated by your shooter and the actual range as determined by pacing or other, more accurate measurement.

### *Immediate hold for Range to Target*

7-36. Immediate range determination holds are based on the zero applied to the weapon. The 300 meter zero is the Army standard and works in all tactical situations, including close quarters combat. Figure 7-7, on page 7-13, shows the appropriate immediate holds for range to target based on the weapon's respective zero:

Aim







RANGE	HOLD	IRON SIGHT	CCO, M68
500 m	1 FORM OVER	USE BDC	
400 m	1/2 HEAD	USE BDC	
300 m	CoVM		
200 m	-1/4 LOW		
100 m	-1/4 LOW		
BDC - Bullet Drop Compensator			

Figure 7-7. Immediate holds for range to target

**Chapter 7**

**MOVING TARGETS**

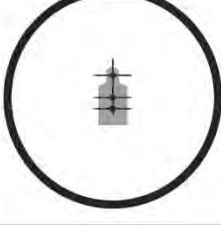
7-37. Moving targets are those threats that appear to have a consistent pace and direction. Targets on any battlefield will not remain stationary for long periods of time, particularly once a firefight begins. Soldiers must have the ability to deliver lethal fires at a variety of moving target types and be comfortable and confident in the engagement techniques. There are two methods for defeating moving targets; tracking and trapping.

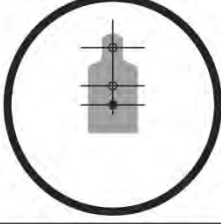
**Immediate hold for moving targets.**

7-38. The immediate hold for moving targets includes an estimation of the speed of the moving target and an estimation of the range to that target. The immediate holds for all moving targets are shown below. (See figure 7-8.)

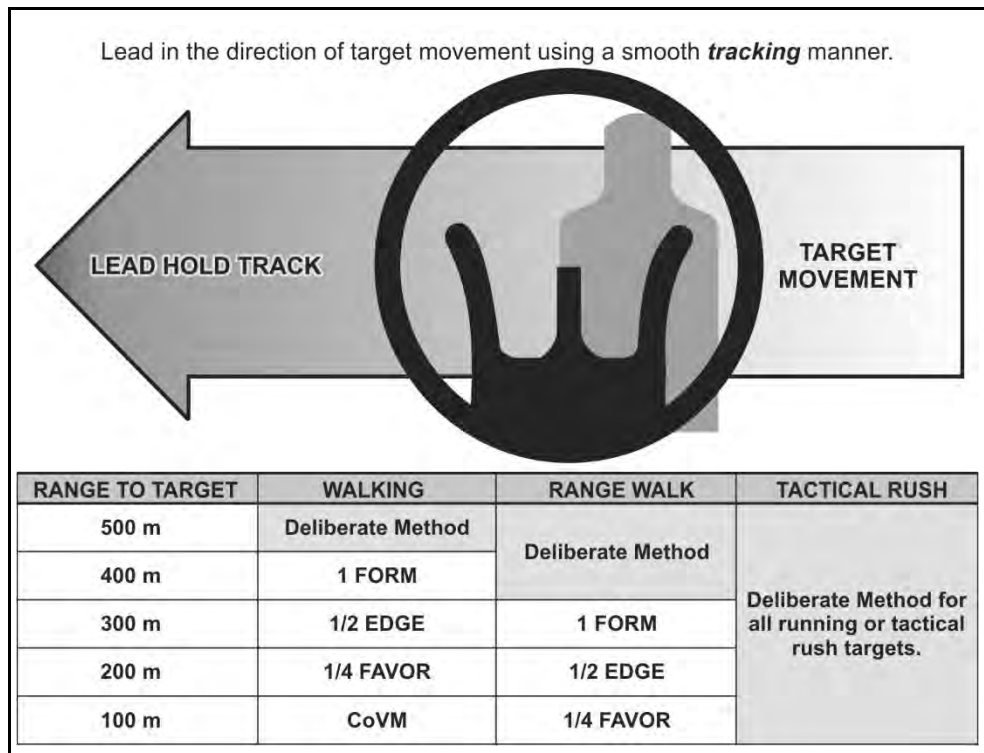

**Figure 7-8. Immediate holds for moving targets example**

Aim

### OBLIQUE TARGETS

7-39. Threats that are moving diagonally toward or away from the shooter are called *oblique targets*. They offer a unique problem set to shooters where the target may be moving at a steady pace and direction; however, their oblique direction of travel makes them appear to move slower.

7-40. Soldiers should adjust their hold based on the angle of the target's movement from the gun-target line. The following guide will help Soldiers determine the appropriate change to the moving target hold to apply to engage the moving oblique threats (see figure 7-9).

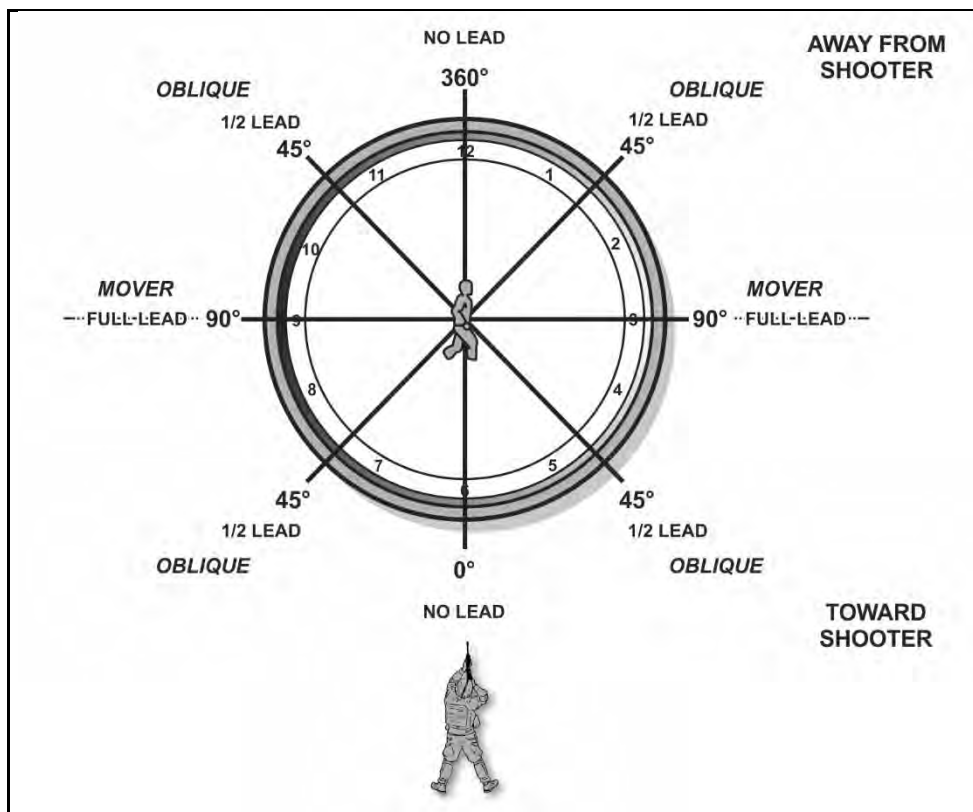

Figure 7-9. Oblique target example



**Chapter 7**

---

**ENVIRONMENTAL CONDITIONS**

7-41. The environment can complicate the shooter's actions during the shot process with excessive wind or requiring angled firing limited visibility conditions. Soldiers must understand the methods to offset or compensate for these firing occasions, and be prepared to apply these skills to the shot process. This includes when multiple complex conditions compound the ballistic solution during the firing occasion.

**WIND**

7-42. Wind is the most common variable and has the greatest effect on ballistic trajectories, where it physically pushes the projectile during flight off the desired trajectory (see appendix B of this publication). The effects of wind can be compensated for by the shooter provided they understand how wind effects the projectile and the terminal point of impact. The elements of wind effects are—

- The time the projectile is exposed to the wind (range).
- The direction from which the wind is blowing.
- The velocity of the wind on the projectile during flight.

**Wind Direction and Value**

7-43. Winds from the left blow the projectile to the right, and winds from the right blow the projectile to the left. The amount of the effect depends on the time of (projectile's exposure) the wind speed and direction. To compensate for the wind, the firer must first determine the wind's direction and value.

7-44. The clock system can be used to determine the direction and value of the wind (See figure 7-10 on page 7-17). Picture a clock with the firer oriented downrange towards 12 o'clock.

7-45. Once the direction is determined, the value of the wind is next. The value of the wind is how much effect the wind will have on the projectile. Winds from certain directions have less effect on projectiles. The chart below shows that winds from 2 to 4 o'clock and 8 to 10 o'clock are considered full-value winds and will have the most effect on the projectile. Winds from 1, 5, 7, and 11 o'clock are considered half-value winds and will have roughly half the effect of a full-value wind. Winds from 6 and 12 o'clock are considered no-value winds and little or no effect on the projectile.

**EXAMPLE**

A 10-mph (miles per hour) wind blowing from the 1 o'clock direction would be a half-value wind and has the same effect as a 5 mph, full-value wind on the projectile.

Aim

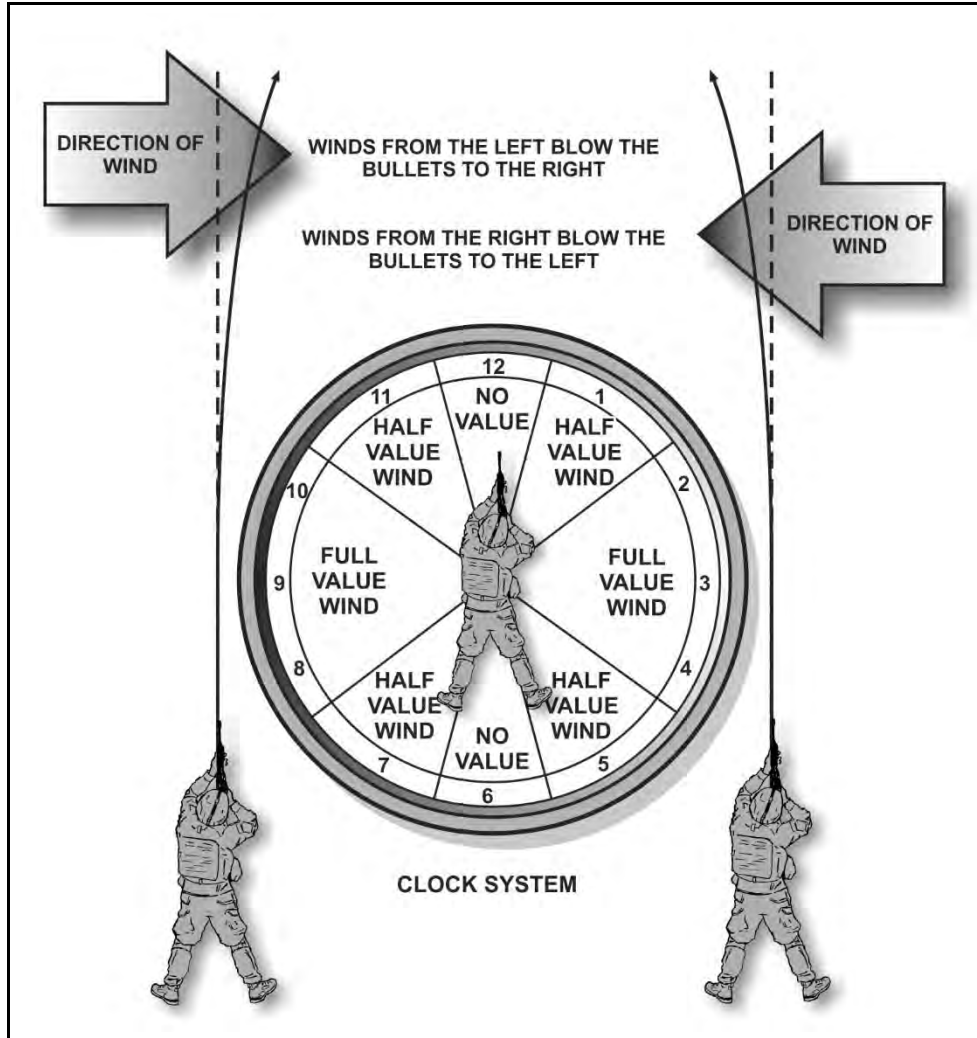
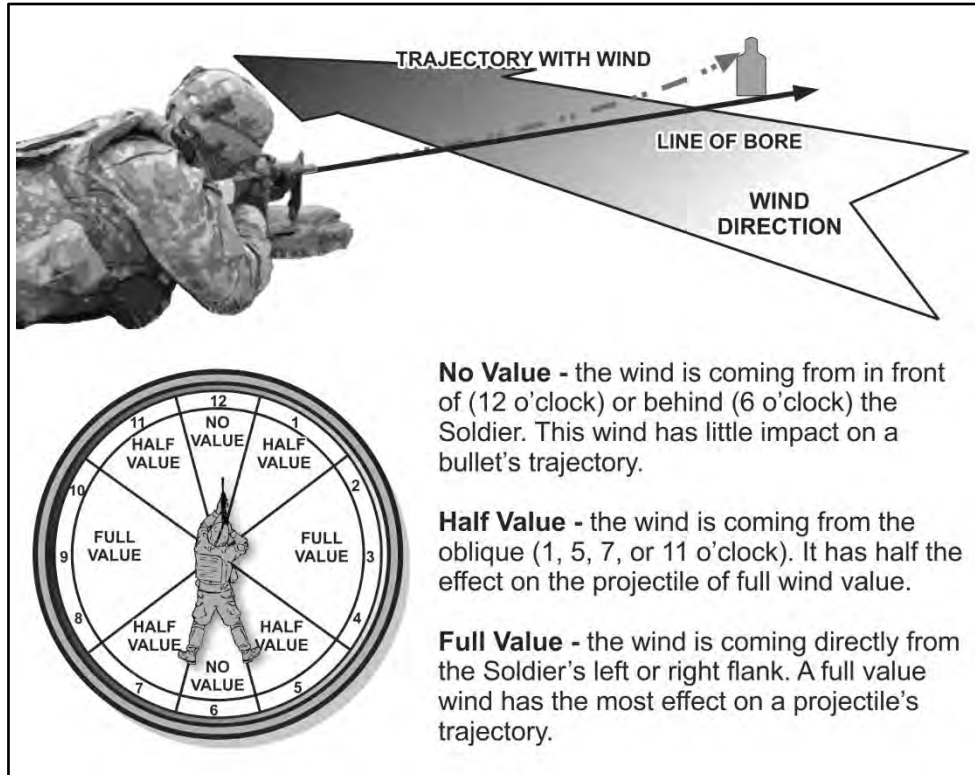

Figure 7-10. Wind value

7-46. The wind will push the projectile in the direction the wind is blowing (see figure 7-11). The amount of effects on the projectile will depend on the time of exposure, direction of the wind, and speed of the wind. To compensate for wind the Soldier uses a hold *in the direction of the wind (into the wind)*.

## Chapter 7



**Figure 7-11. Wind effects**

### Wind Speed

7-47. Wind speeds can vary from the firing line to the target. Wind speed can be determined by taking an average of the winds blowing on the range. The firer's focus should be on the winds between the midrange point and the target. The wind at the one half to two thirds mark will have the most effect on the projectile since that is the point where most projectiles have lost a large portion of their velocity and are beginning to destabilize.

7-48. The Soldier can observe the movement of items in the environment downrange to determine the speed. Each environment will have different vegetation that reacts differently.

7-49. Downrange wind indicators include the following:

- 0 to 3 mph = Hardly felt, but smoke drifts.
- 3 to 5 mph = Felt lightly on the face.
- 5 to 8 mph = Keeps leaves in constant movement.

**Chapter 7**

- 8 to 12 mph = Raises dust and loose paper.
- 12 to 15 mph = Causes small trees to sway.

7-50. The wind blowing at the Soldiers location may not be the same as the wind blowing on the way to the target.

**Wind Estimation**

7-51. Soldiers must be comfortable and confident in their ability to judge the effects of the wind to consistently make accurate and precise shots. Soldiers will use wind indicators between the Soldier and the target that provide windage information to develop the proper compensation or hold-off.

7-52. To estimate the effects of the wind on the shot, Soldiers need to determine three windage factors:

- Velocity (speed).
- Direction.
- Value.

**Immediate Wind Hold**

7-53. Using a hold involves changing the point of aim to compensate for the wind drift. For example, if wind causes the bullet to drift 1/2 form to the left, the aiming point must be moved 1/2 form to the right. (See figure 7-12, page 7-20.)

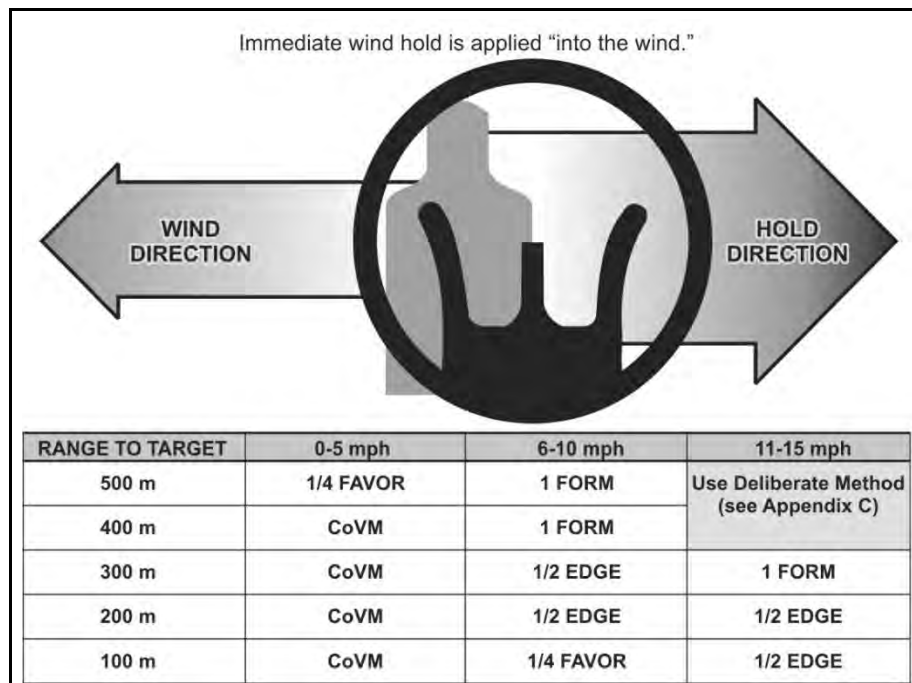

**Figure 7-12. Wind hold example**

## Chapter 7

---

7-54. Firers must adjust their points of aim into the wind to compensate for its effects. If they miss a distant target and wind is blowing from the right, they should aim to the right for the next shot. A guide for the initial adjustment is to split the front sight post on the edge of the target facing the wind.

7-55. Newly assigned Soldiers should aim at the target's center of visible mass for the first shot, and then adjust for wind when they are confident that wind caused the miss. Experienced firers should apply the appropriate hold for the first shot, but should follow the basic rule—when in doubt, aim at the center of mass.

### LIMITED VISIBILITY

7-56. Soldiers must be lethal at night and in limited visibility conditions, as well as during the day. That lethality depends largely on whether Soldier can fire effectively with today's technology: night vision devices (NVDs), IR aiming devices, and TWSs.

7-57. Limited visibility conditions may limit the viewable size of a threat, or cause targets to be lost after acquisition. In these situations, Soldiers may choose to apply a hold for where a target is *expected* to be rather than wait for the target to present itself for a more refined reticle lay or sight picture.

7-58. Soldiers may switch between optics, thermals, and pointers to refine their point of aim. To rapidly switch between aiming devices during operations in limited visibility, the Soldier must ensure accurate alignment, boresighting, and zeroing of all associated equipment. Confidence in the equipment is achieved through drills related to changing the aiming device during engagements, executing repetitions with multiple pieces of equipment, and practicing nonstandard engagement techniques using multiple aiming devices in tandem (IR pointer with NVDs, for example).

## Chapter 8

# Control

The control element of employment considers all the conscious actions of the Soldier before, during, and after the shot process that the Soldier's specifically in control of. It incorporates the Soldier as a function of safety, as well as the ultimate responsibility of firing the weapon.

Proper trigger control, without disturbing the sights, is the most important aspect of control and the most difficult to master.

Combat is the ultimate test of a Soldier's ability to apply the functional elements of the shot process and firing skills. Soldiers must apply the employment skills mastered during training to all combat situations (for example, attack, assault, ambush, or urban operations). Although these tactical situations present problems, the application of the functional elements of the shot process require two additions: changes to the rate of fire and alterations in weapon/target alignment. This chapter discusses the engagement techniques Soldiers must adapt to the continuously changing combat engagements.

8-1. When firing individual weapons, the Soldier is the weapon's fire control system, ballistic computer, stabilization system, and means of mobility. Control refers to the Soldier's ability to regulate these functions and maintain the discipline to execute the shot process at the appropriate time.

8-2. Regardless of how well trained or physically strong a Soldier is, a wobble area (or arc of movement) is present, even when sufficient physical support of the weapon is provided. The arc of movement (AM) may be observed as the sights moving in a W shape, vertical (up and down) pulses, circular, or horizontal arcs depending on the individual Soldier, regardless of their proficiency in applying the functional elements. The wobble area or arc of movement is the extent of lateral horizontal and front-to-back variance in the movement that occurs in the sight picture (see figure 8-1).

## Chapter 8

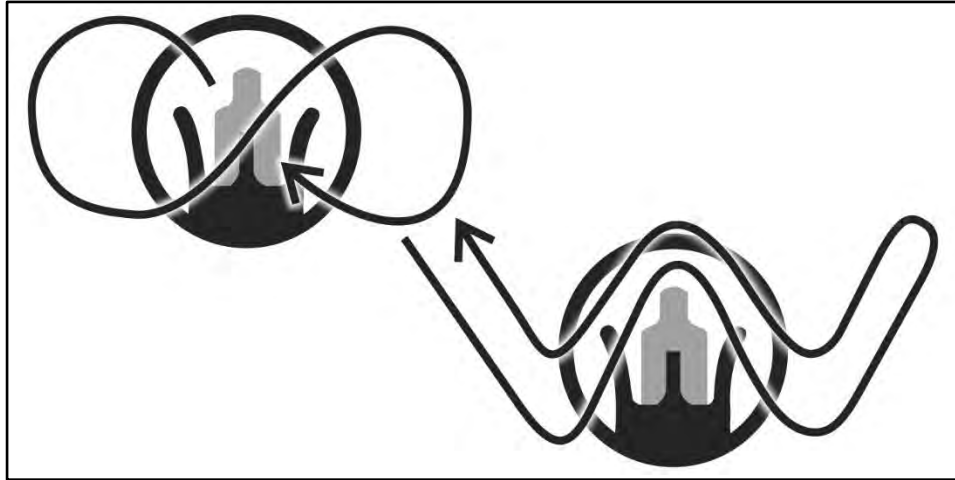

**Figure 8-1. Arc of movement example**

8-3. The control element consists of several supporting Soldier functions, and include all the actions to minimize the Soldier's induced arc of movement. Executed correctly, it provides for the best engagement window of opportunity to the firer. The Soldier physically maintains positive control of the shot process by managing—

- Trigger control.
- Breathing control.
- Workspace.
- Calling the shot (firing or shot execution).
- Follow-through.

## TRIGGER CONTROL

8-4. Trigger control is the act of firing the weapon while maintaining proper aim and adequate stabilization until the bullet leaves the muzzle. Trigger control and the shooter's position work together to allow the sights to stay on the target long enough for the shooter to fire the weapon and bullet to exit the barrel.

8-5. Stability and trigger control complement each other and are integrated during the shot process. A stable position assists in aiming and reduces unwanted movements during trigger squeeze without inducing unnecessary movement or disturbing the sight picture. A smooth, consistent trigger squeeze, regardless of speed, allows the shot to fire at the Soldier's moment of choosing. When both a solid position and a good trigger squeeze are achieved, any induced shooting errors can be attributed to the aiming process for refinement.

8-6. Smooth trigger control is facilitated by placing the finger where it naturally lays on the trigger. Natural placement of the finger on the trigger will allow for the best mechanical advantage when applying rearward pressure to the trigger.

**Control**

- **Trigger finger placement** – the trigger finger will lay naturally across the trigger after achieving proper grip (see figure 8-2). There is no specified point on the trigger finger that must be used. It will not be the same for all Soldiers due to different size hands. This allows the Soldier to engage the trigger in the most effective manner
- **Trigger squeeze** – The Soldier pulls the trigger in a smooth consistent manner adding pressure until the weapon fires. Regardless of the speed at which the Soldier is firing the trigger control will always be smooth.
- **Trigger reset** – It is important the Soldier retains focus on the sights while resetting the trigger.

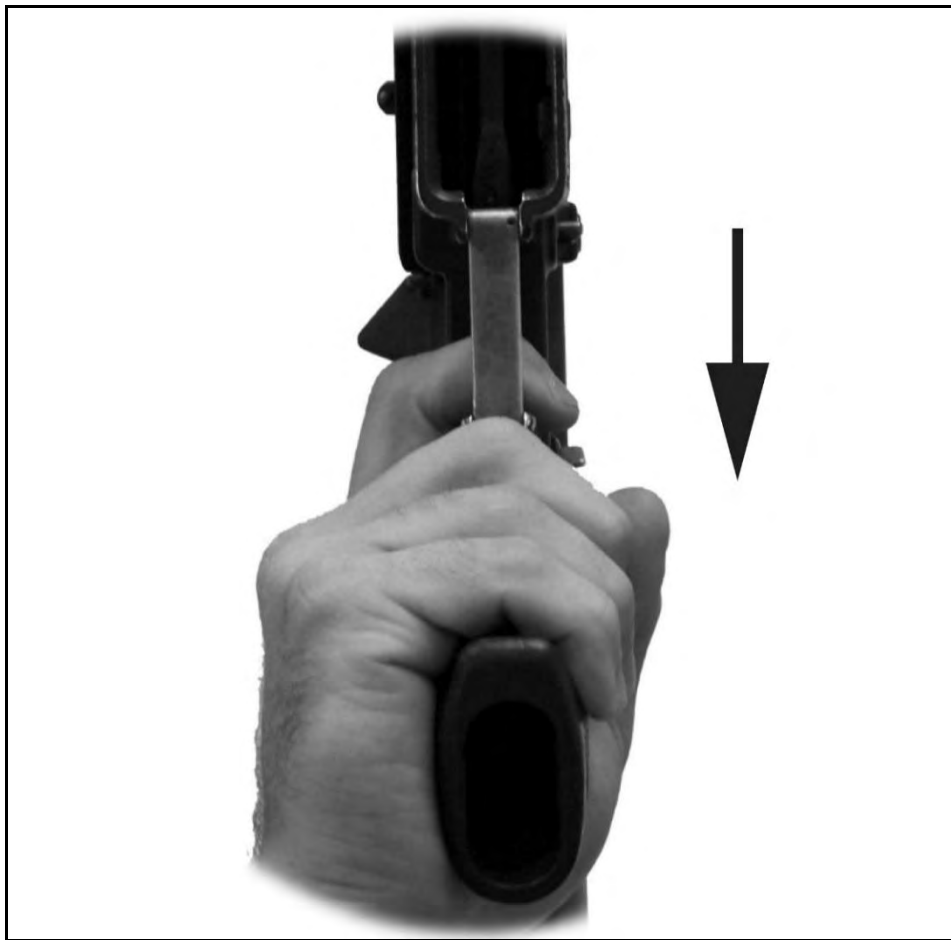

**Figure 8-2. Natural trigger finger placement**



## Chapter 8

---

### BREATHING CONTROL

8-7. During the shot process, the shooter controls their breathing to reduce the amount of movement of the weapon. During training, the Soldier will learn a method of breathing control that best suits their shooting style and preference. Breathing control is the relationship of the respiratory process (free or under stress) and the decision to execute the shot with trigger squeeze.

8-8. Breathing induces unavoidable body movement that contribute to wobble or the arc of movement (AM) during the shot process. Soldiers cannot completely eliminate all motion during the shot process, but they can significantly reduce its effects through practice and technique. Firing on the natural pause is a common technique used during grouping and zeroing.

8-9. Vertical dispersion during grouping is most likely not caused by breathing but by failure to maintain proper aiming and trigger control. Refer to appendix E of this publication for proper target analysis techniques.

### WORKSPACE MANAGEMENT

8-10. The workspace is a spherical area, 12 to 18 inches in diameter centered on the Soldier's chin and approximately 12 inches in front of their chin. The workspace is where the majority of weapons manipulations take place. (See figure 8-3 on page 8-5.)

8-11. Conducting manipulations in the workspace allows the Soldier to keep his eyes oriented towards a threat or his individual sector of fire while conducting critical weapons tasks that require hand and eye coordination. Use of the workspace creates efficiency of motion by minimizing the distance the weapon has to move between the firing position to the workspace and return to the firing position.

8-12. Location of the workspace will change slightly in different firing positions. There are various techniques to use the workspace. Some examples are leaving the butt stock in the shoulder, tucking the butt stock under the armpit for added control of the weapon, or placing the butt stock in the crook of the elbow.

8-13. Workspace management includes the Soldier's ability to perform the following functions:

- **Selector lever** – to change the weapon's status from safe to semiautomatic, to burst/automatic from any position.

---

*Note.* Some models will have ambidextrous selectors.

---

- **Charging handle** – to smoothly use the charging handle during operation. This includes any corrective actions to overcome malfunctions, loading, unloading, or clearing procedures.
- **Bolt catch** – to operate the bolt catch mechanism on the weapon during operations.
- **Ejection port** – closing the ejection port cover to protect the bolt carrier assembly, ammunition, and chamber from external debris upon completion

**Control**

of an engagement. This includes observation of the ejection port area during malfunctions and clearing procedures.

- **Magazine catch** – the smooth functioning of the magazine catch during reloading procedures, clearing procedures, or malfunction corrective actions.
- **Chamber check** – the sequence used to verify the status of the weapon’s chamber.
- **Forward assist** – the routine use of the forward assist assembly of the weapon during loading procedures or when correcting malfunctions.

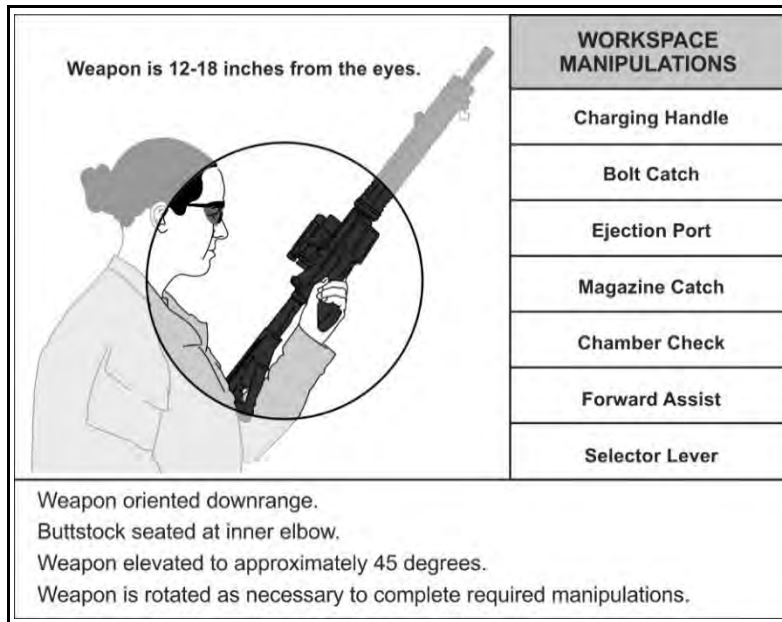

**Figure 8-3. Workspace example**

**CALLING THE SHOT**

8-14. Knowing precisely where the sights are when the weapon discharges is critical for shot analysis. Errors such as flinching or jerking of the trigger can be seen in the sights before discharge.

8-15. Calling a shot refers to a firer stating exactly where he thinks a single shot strikes by recalling the sights relationship to the target when the weapon fired. This is normally expressed in clock direction and inches from the desired point of aim.

8-16. The shooter is responsible for the point of impact of every round fired from their weapon. This requires the Soldier to ensure the target area is clear of friendly and neutral actors, in front of and behind the target. Soldiers must also be aware of the environment the target is positioned in, particularly in urban settings—friendly or neutral actors may be present in other areas of a structure that the projectile can pass through.

## Chapter 8

---

### **RATE OF FIRE**

8-17. The shooter must determine *how* to engage the threat with the weapon, on the current shot as well as subsequent shots. Following the direction of the team leader, the Soldier controls the rate of fire to deliver consistent, lethal, and precise fires against the threat.

### **SLOW SEMIAUTOMATIC FIRE**

8-18. Slow semiautomatic fire is moderately paced at the discretion of the Soldier, typically used in a training environment or a secure defensive position at approximately 12 to 15 rounds per minute. All Soldiers learn the techniques of slow semiautomatic fire during their introduction to the service rifle during initial entry training. This type of firing provides the Soldier the most time to focus on the functional elements in the shot process and reinforces all previous training.

### **RAPID SEMIAUTOMATIC FIRE**

8-19. Rapid semiautomatic fire is approximately 45 rounds per minute and is typically used for multiple targets or combat scenarios where the Soldier does not have overmatch of the threat. Soldiers should be well-trained in all aspects of slow semiautomatic firing before attempting any rapid semiautomatic fire training.

8-20. Those who display a lack of knowledge of employment skills should not advance to rapid semiautomatic fire training until these skills are learned and mastered.

### **AUTOMATIC OR BURST FIRE**

8-21. Automatic or burst fire is when the Soldier is required to provide suppressive fires with accuracy, and the need for precise fires, although desired, is not as important. Automatic or burst fires drastically decrease the probability of hit due to the rapid succession of recoil impulses and the inability of the Soldier to maintain proper sight alignment and sight picture on the target.

8-22. Soldiers should be well-trained in all aspects of slow semiautomatic firing before attempting any automatic training.

## FOLLOW-THROUGH

8-23. Follow-through is the continued mental and physical application of the functional elements of the shot process after the shot has been fired. The firer's head stays in contact with the stock, the firing eye remains open, the trigger finger holds the trigger back through recoil and then lets off enough to reset the trigger, and the body position and breathing remain steady.

8-24. Follow-through consists of all actions controlled by the shooter after the bullet leaves the muzzle. It is required to complete the shot process. These actions are executed in a general sequence:

- **Recoil management.** This includes the bolt carrier group recoiling completely and returning to battery.
- **Recoil recovery.** Returning to the same pre-shot position and reacquiring the sight picture. The shooter should have a good sight picture before and after the shot.
- **Trigger/Sear reset.** Once the ejection phase of the cycle of function is complete, the weapon initiates and completes the cocking phase. As part of the cocking phase, all mechanical components associated with the trigger, disconnect, and sear are reset. Any failures in the cocking phase indicate a weapon malfunction and require the shooter to take the appropriate action. The shooter maintains trigger finger placement and releases pressure on the trigger until the sear is reset, demonstrated by a metallic click. At this point the sear is reset and the trigger pre-staged for a subsequent or supplemental engagement if needed.
- **Sight picture adjustment.** Counteracting the physical changes in the sight picture caused by recoil impulses and returning the sight picture onto the target aiming point.
- **Engagement assessment.** Once the sight picture returns to the original point of aim, the firer confirms the strike of the round, assesses the target's state, and immediately selects one of the following courses of action:
  - **Subsequent engagement.** The target requires additional (subsequent) rounds to achieve the desired target effect. The shooter starts the pre-shot process.
  - **Supplemental engagement.** The shooter determines the desired target effect is achieved and another target may require servicing. The shooter starts the pre-shot process.
  - **Sector check.** All threats have been adequately serviced to the desired effect. The shooter then checks his sector of responsibility for additional threats as the tactical situation dictates. The unit's SOP will dictate any vocal announcements required during the post-shot sequence.
  - **Correct Malfunction.** If the firer determines during the follow-through that the weapon failed during one of the phases of the cycle of function, they make the appropriate announcement to their team and immediately execute corrective action.

## Chapter 8

---

### MALFUNCTIONS

8-25. When any weapon fails to complete any phase of the cycle of function correctly, a malfunction has occurred. When a malfunction occurs, the Soldier's priority remains to defeat the target as quickly as possible. The malfunction, Soldier capability, and secondary weapon capability determine if, when, and how to transition to a secondary weapon system.

8-26. The Soldier controls which actions must be taken to ensure the target is defeated as quickly as possible based on secondary weapon availability and capability, and the level of threat presented by the range to target and its capability:

- **Secondary weapon can defeat the threat.** Soldier transitions to secondary weapon for the engagement. If no secondary weapon is available, announce their status to the small team, and move to a covered position to correct the malfunction.
- **Secondary weapon cannot defeat the threat.** Soldiers quickly move to a covered position, announce their status to the small team, and execute corrective action.
- **No secondary weapon.** Soldiers quickly move to a covered position, announce their status to the small team, and execute corrective action.

8-27. The end state of any of corrective action is a properly functioning weapon. Typically, the phase where the malfunction occurred within the cycle of function identifies the general problem that must be corrected. From a practical, combat perspective, malfunctions are recognized by their symptoms. Although some symptoms do not specifically identify a single point of failure, they provide the best indication on which corrective action to apply.

8-28. To overcome the malfunction, the Soldier must first avoid over analyzing the issue. The Soldier must train to execute corrective actions immediately without hesitation or investigation during combat conditions.

8-29. There are two general types of corrective action:

- **Immediate action** – simple, rapid actions or motions taken by the Soldier to correct basic disruptions in the cycle of function of the weapon. Immediate action is taken when a malfunction occurs such that the trigger is squeeze and the hammer falls with an audible “click.”
- **Remedial action** – a skilled, technique that must be applied to a specific problem or issue with the weapon that will not be corrected by taking immediate action. Remedial action is taken when the cycle of function is interrupted where the trigger is squeezed and either has little resistance during the squeeze (“mush”) or the trigger cannot be squeezed.

8-30. No single corrective action solution will resolve *all* or *every* malfunction. Soldiers need to understand what failed to occur, as well as any specific sounds or actions of the weapon in order to apply the appropriate correction measures.

---

**Control**

8-31. Immediate action can correct rudimentary failures during the cycle of function:

- **Failure to fire** – is when a round is locked into the chamber, the weapon is ready to fire, the select switch is placed on SEMI or BURST / AUTO, and the trigger is squeezed, the hammer falls (audible click), and the weapon does not fire.
- **Failure to feed** – is when the bolt carrier assembly is expected to move return back into battery but *is prevented from moving all the way forward*. A clear gap can be seen between the bolt carrier assembly and the forward edge of the ejection port. This failure may cause a stove pipe or a double feed (see below).
- **Failure to chamber** – when the round is being fed into the chamber, but the bolt carrier assembly does not fully seat forward, failing to chamber the round and lock the bolt locking lugs with the barrel extension's corresponding lugs.
- **Failure to extract** – when either automatically or manually, the extractor loses its grip on the cartridge case or the bolt seizes movement rearward during extraction that leaves the cartridge case partially removed or fully seated.
- **Failure to eject** – occurs when, either automatically or manually, a cartridge case is extracted from the chamber fully, but does not leave the upper receiver through the ejection port.

8-32. Remedial action requires the Soldier to quickly identify one of four issues and apply a specific technique to correct the malfunction. Remedial action is required to correct the following types of malfunctions or symptoms:

- **Immediate action fails to correct symptom** – when a malfunction occurred that initiated the Soldier to execute immediate action and multiple attempts failed to correct the malfunction. A minimum of two cycles of immediate action should have been completed; first, without a magazine change, and the second with a magazine change.
- **Stove pipe** – can occur when either a feeding cartridge or an expended cartridge case is pushed sideways during the cycle of function causing that casing to stop the forward movement of the bolt carrier assembly and lodge itself between the face of the bolt and the ejection port.
- **Double feed** – occurs when a round is chambered and not fired and a subsequent round is being fed without the chamber being clear.
- **Bolt override** – is when the bolt fails to push a new cartridge out of the magazine during feeding or chambering, causing the bolt to ride on top of the cartridge.
- **Charging handle impingement** – when a round becomes stuck between the bolt assembly and the charging handle where the charging handle is not in the forward, locked position.

8-33. Although there are other types of malfunctions or disruptions to the cycle of function, those listed above are the most common. Any other malfunction will require additional time to determine the true point of failure and an appropriate remedy.

## Chapter 8

---

*Note.* When malfunctions occur in combat, the Soldier must announce STOPPAGE or another similar term to their small unit, quickly move to a covered location, and correct the malfunction as rapidly as possible. If the threat is too close to the Soldier or friendly forces, and the Soldier has a secondary weapon, the Soldier should immediately transition to secondary to defeat the target prior to correcting the malfunction.

---

### RULES FOR CORRECTING A MALFUNCTION

- 8-34. To clear a malfunction, the Soldier must—
- **Apply Rule #1.** Soldiers must remain coherent of their weapon and continue to treat their weapon as if it is loaded when correcting malfunctions.
  - **Apply Rule #2.** Soldiers must ensure the weapon's orientation is appropriate for the tactical situation and not flag other friendly forces when correcting malfunctions.
  - **Apply Rule #3.** Take the trigger finger off the trigger, keep it straight along the lower receiver placed outside of the trigger guard.
  - **Do not attempt to place the weapon on SAFE** (unless otherwise noted). Most stoppages will not allow the weapon to be placed on safe because the sear has been released or the weapon is out of battery. Attempting to place the weapon on SAFE will waste time and potentially damage the weapon.
  - **Treat the symptom.** Each problem will have its own specific symptoms. By reacting to what the weapon is “telling” the Soldier, they will be able to quickly correct the malfunction.
  - **Maintain focus on the threat.** The Soldier must keep their head and eyes looking downrange at the threat, not at the weapon. If the initial corrective action fails to correct the malfunction, the Soldier must be able to quickly move to the next most probable corrective action.
  - **Look last.** Do not look and analyze the weapon to determine the cause of the malfunction. Execute the drill that has the highest probability of correcting the malfunction.
  - **Check the weapon.** Once the malfunction is clear and the threat is eliminated, deliberately check the weapon when in a covered location for any potential issues or contributing factors that caused the malfunction and correct them.

**Control**

**Perform Immediate Action**

8-35. To perform immediate action, the Soldier instinctively:

- Hears the hammer fall with an audible “click.”
- Taps the bottom of the magazine firmly.
- Rapidly pulls the charging handle and releases to extract / eject the previous cartridge and feed, chamber, and lock a new round.
- Reassess by continuing the shot process.

---

*Note.* If a malfunction continues to occur with the same symptoms, the Soldier will remove the magazine and insert a new loaded magazine, then repeat the steps above.

---

**Perform Remedial Action**

8-36. To perform remedial action, the Soldier must have a clear understanding of where the weapon failed during the cycle of function. Remedial action executed when one of the following conditions exist:

- Immediate action does not work after two attempts.
- The trigger refuses to be squeezed.
- The trigger feels like “mush” when squeezed.

8-37. When one of these three symptoms exist, the Soldier looks into the chamber area through the ejection port to quickly assess the type of malfunction. Once identified, the Soldier executes actions to “reduce” the symptom by removing the magazine and attempting to clear the weapon. Once complete, visually inspect the chamber area, bolt face, and charging handle. Then, complete the actions for the identified symptom:

- **Stove pipe** – Grasp case and attempt to remove, cycle weapon and attempt to fire. If this fails, pull charging handle to the rear while holding case.
- **Double-feed** - the Soldier must remove the magazine, clear the weapon, confirm the chamber area is clear, secure a new loaded magazine into the magazine well, and chamber and lock a round.
- **Bolt override** – Remove magazine. Pull charging handle as far rearward as possible. Strike charging handle forward. If this fails, pull charging handle to the rear a second time, use tool or finger to hold the bolt to the rear, sharply send charging handle forward.





**Chapter 8**

**CORRECTING MALFUNCTIONS**

8-38. Figure 8-4 below provides a simple mental flow chart to rapidly overcome malfunctions experienced during the shot process.

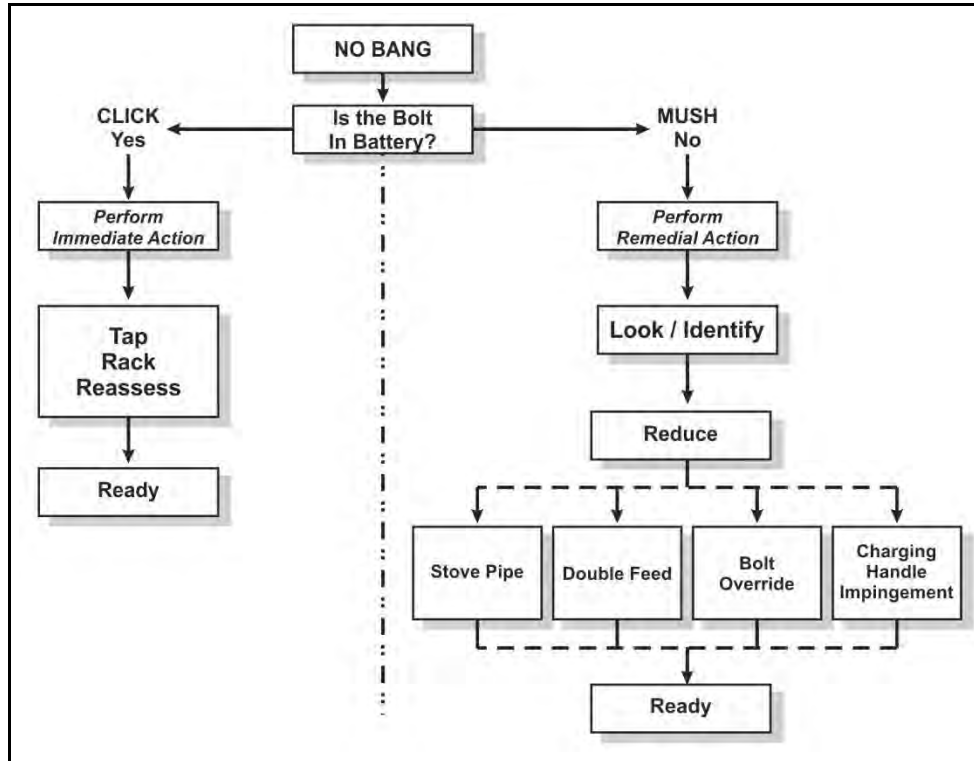

**Figure 8-4. Malfunction corrective action flow chart**

---

**Control**

**COOK-OFF**

8-39. Rapid and continuous firing of several magazines in sequence without cooling, will severely elevate chamber temperatures. While unlikely this elevated temperature may cause a malfunction known as a "cook-off". A "cook-off" may occur while the round is locked in the chamber, due to excessive heating of the ammunition. Or the rapid exposure to the cooler air outside of the chamber, due in part to the change in pressure.

8-40. If the Soldier determines that he has a potential "cook-off" situation he should leave the weapon directed at the target, or in a known safe direction, and follow proper weapons handling procedures, until the barrel of the weapon has had time to cool. If the chambered round has not been locked in the chamber for 10 seconds, it should be ejected as quickly as possible. If the length of time is questionable or known to be longer than 10 seconds and it is tactically sound, the Soldier should follow the above procedures until the weapon is cooled. If it is necessary to remove the round before the weapon has time to cool, the Soldier should do so with care as the ejected round may detonate due to rapid cooling in open air.

**WARNING**

**Ammunition "cook-off" is not likely in well maintained weapons used within normal training and combat parameters.**

**Soldiers and unit leadership need to consider the dangers of keeping rounds chambered in weapons that have elevated temperatures due to excessive firing. Or clearing ammunition that has the potential to cook-off when exposed to the cooler air outside of the chamber.**

**Exposure to the colder air outside of the chamber has the potential to cause the "cook-off" of ammunition. Keeping ammunition chambered in severely elevated temperatures also has the potential to cause the "cook-off" of ammunition.**

---

*Note.* For more information about troubleshooting malfunctions and replacing components, see organizational and direct support maintenance publications and manuals.

---

**Chapter 8**

---

**TRANSITION TO SECONDARY WEAPON**

8-41. A secondary weapon, such as a pistol, is the most efficient way to engage a target at close quarters when the primary weapon has malfunctioned. The Soldier controls which actions must be taken to ensure the target is defeated as quickly as possible based on the threat presented.

8-42. The firer transitions by taking the secondary weapon from the HANG or HOLSTERED position to the READY UP position, reacquiring the target, and resuming the shot process as appropriate.

8-43. Refer to the appropriate secondary weapon's training publications for the specific procedures to complete the transition process.

## Chapter 9

# Movement

The movement functional element is the process of the Soldier moving tactically during the engagement process. It includes the Soldier's ability to move laterally, forward, diagonally, and in a retrograde manner while maintaining stabilization, appropriate aim, and control of the weapon.

Proper application of the shot process during movement is vital to combat operations. The most complex engagements involve movement of both Soldier and the adversary. The importance of sight alignment and trigger control are at their highest during movement. The movement of the Soldier degrades stability, the ability to aim, and creates challenges to proper trigger control.

## MOVEMENT TECHNIQUES

9-1. Tactical movement of the Soldier is classified in two ways: vertical and horizontal. Each require specific considerations to maintain and adequately apply the other functional elements during the shot process.

9-2. **Vertical movements** are those actions taken to change their firing posture or negotiate terrain or obstacles while actively seeking, orienting on, or engaging threats. Vertical movements include actions taken to—

- Change between any of the primary firing positions; standing, crouched, kneeling, sitting, or prone.
- Negotiate stairwells in urban environments.
- Travel across inclined or descending surfaces, obstacles, or terrain.

9-3. **Horizontal movements** are actions taken to negotiate the battlefield while actively seeking, orienting on, or engaging threats. There are eight horizontal movement techniques while maintaining weapon orientation on the threat—

- **Forward** – movement in a direction directly toward the adversary.
- **Retrograde** – movement rearward, in a direction away from the threat while maintaining weapon orientation on the threat.
- **Lateral right/left** – lateral, diagonal, forward, or retrograde movement to the right or left.
- **Turning left/right/about** – actions taken by the Soldier to change the weapon orientation left/right or to the rear, followed by the Soldier's direction of travel turning to the same orientation.

## Chapter 9

---

### FORWARD MOVEMENT

9-4. Forward movement is continued progress in a direction toward the adversary or route of march. This is the most basic form of movement during an engagement.

#### TECHNIQUE

9-5. During forward movement,—

- Roll the foot heel to toe to best provide a stable firing platform.
- Shooting while moving should be very close to the natural walking gait and come directly from the position obtained while stationary.
- Keep the weapon at the ready position. Always maintain awareness of the surroundings, both to your left and right, at all times during movement.
- Maintain an aggressive position.
- The feet should almost fall in line during movement. This straight-line movement will reduce the arc of movement and visible “bouncing” of the sight picture.
- Keep the muzzle of the weapon facing down range toward the expected or detected threat.
- Keep the hips as stationary as possible. Use the upper body as a turret, twisting at the waist, maintaining proper platform with the upper body.

### RETROGRADE MOVEMENT

9-6. Retrograde movement is where the orientation of the weapon remains to the Soldier’s front while the Soldier methodically moves rearward.

#### TECHNIQUE

9-7. During retrograde movement, the Soldier should—

- Take only one or two steps that will open the distance or reposition the feet.
- Place the feet in a toe to heel manner and drop the center body mass by consciously bending the knees, using a reverse combat glide.
- Maintain situational awareness of team members, debris, and terrain.
- Use the knees as a shock absorber to steady the body movement to maintain the stability of the upper body, stabilizing the rifle sight(s) on the target.
- Ensure all movement is smooth and steady to maintain stability.
- Bend forward at the waist to put as much mass as possible behind the weapon for recoil management.
- Keep the muzzle oriented downrange toward the expected or detected threat.
- Keep the hips as stationary as possible. Use the upper body as a turret, twisting at the waist, maintaining proper platform with the upper body.

---

**Movement**

## **LATERAL MOVEMENT**

9-8. Lateral movement is where the Soldier maintains weapon orientation downrange at the expected or detected threat while moving to the left or right. In the most extreme cases, the target will be offset 90 degrees or more from the direction of movement.

### **TECHNIQUE**

9-9. During lateral movement, Soldiers should—

- Place their feet heel to toe and drop their center mass by consciously bending the knees.
- Use the knees as a shock absorber to steady the body movement to maintain the stability of the upper body, stabilizing the rifle sight(s) on the target.
- Ensure all movement is smooth and steady to maintain stability.
- Bend forward at the waist to put as much mass as possible behind the weapon for recoil management.
- Roll the foot, heel to toe, as you place the foot on the ground and lift it up again to provide for the smoothest motion possible.
- Keep the weapon at the alert or ready carry. Do not aim in on the target until ready to engage.
- Maintain awareness of the surroundings, both to the left and right, at all times during movement.
- Trigger control when moving is based on the wobble area. The Soldier shoots when the sights are most stable, not based on foot position.
- Keep the muzzle of the weapon facing down range toward the threat.
- When moving, the placement of the feet should be heel to toe.
- Do not overstep or cross the feet, because this can decrease the Soldier's balance and center of gravity.
- Keep the hips as stationary as possible. Use the upper body as a turret, twisting at the waist, maintaining proper platform with the upper body.

---

*Note.* It is more difficult to engage adversaries to the firing side while moving laterally. The twist required to achieve a full 90-degree offset requires proper repetitive training. The basic concept of movement must be maintained, from foot placement to platform.

Twisting at the waist will not allow the weapon to be brought to a full 90 degrees off the direction of travel, especially with nonadjustable butt stocks. The Soldier will need to drop the non-firing shoulder and roll the upper body toward the nonfiring side. This will cause the weapon and upper body to cant at approximately a 45-degree angle, relieving some tension in the abdominal region, allowing the Soldier to gain a few more degrees of offset.

---

**Chapter 9**

---

**TURNING MOVEMENT**

9-10. Turning movement are used to engage widely dispersed targets in the oblique and on the flanks. Turning skills are just as valuable in a rapidly changing combat environment as firing on the move (such as lateral movement) skills are and should only be used with the alert carry.

9-11. It does not matter which direction the Soldier is turning or which side is the Soldier's strong side. The Soldier must maintain the weapon at an exaggerated low-alert carry for the duration of the turn.

9-12. Muzzle awareness must be maintained at all times. Ensure that the muzzle does not begin to come up on target the body is completely turned toward the threat.

9-13. When executing a turn to either side, the Soldier will—

- **Look first.** Turn head to the direction of the turn first.
- **Weapon follows the eyes.** The Soldier moves the weapon smoothly to where the eyes go.
- **Follow with the body.** The body will begin movement with the movement of the weapon. Soldiers finish the body movement smoothly to maintain the best possible stability for the weapon.
- **Maintain situational awareness.** The Soldier must be completely aware of the surrounding terrain, particularly for tripping hazards. When necessary, Soldiers should visually check their surroundings during the turning action and return their vision to the target area as quickly as possible.

## Appendix A

# Ammunition

Appendix A discusses the characteristics and capabilities of the different ammunition available for the M4- and M16-series weapons. It also includes general ammunition information such as packaging, standard and North Atlantic Treaty Organization (NATO) marking conventions, the components of ammunition, and general principles of operation. The information within this appendix is 5.56mm for the M4- and M16-series weapons only.

### SMALL ARMS AMMUNITION CARTRIDGES

A-1. Ammunition for use in rifles and carbines is described as a cartridge. A small arms cartridge (see figure A-1) is an assembly consisting of a cartridge case, a primer, a quantity of propellant, and a bullet. The following terminology describe the general components of all small arms ammunition (SAA) cartridges:

- **Cartridge case.** The cartridge case is a brass, rimless, center-fire case that provides a means to hold the other components of the cartridge.
- **Propellant.** The propellant (or powder) provides the energy to propel the projectile through the barrel and downrange towards a target through combustion.
- **Primer.** The primer is a small explosive charge that provides an ignition source for the propellant.
- **Bullet.** The bullet or projectile is the only component that travels to the target.

---

*Note.* Dummy cartridges are composed of a cartridge case and bullet, with no primer or propellant. Some dummy cartridges contain inert granular materials to simulate the weight and balance of live cartridges.

---

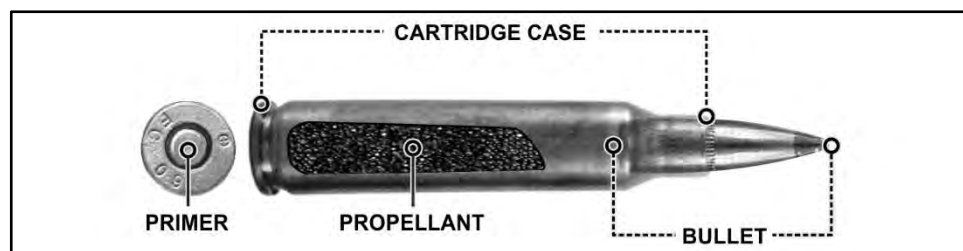

Figure A-1. Small arms ammunition cartridges



**Appendix A**

---

A-2. There are multiple types of bullets used for various purposes. These include ball, tracer, armor-piercing, blank, special ball long range (LR), dummy, and short range training.

A-3. The cartridge case is made of steel, aluminum, or a brass combination (70 percent copper and 30 percent zinc) for military use. The M4- and M16-series weapons is a rimless cartridge case that provides an extraction groove (shown in figure A-2). These cartridge cases are designed to support center-fire operation.

A-4. Center-fire cases have a centrally located primer well/pocket in the base of the case, which separates the primer from the propellant in the cartridge case. These cases are designed to withstand pressures generated during firing and are used for most small arms.

A-5. All 5.56mm ammunition uses the rimless cartridge case. A rimless cartridge is where the rim diameter is the same as the case body, and uses an extractor groove to facilitate the cycle of functioning. This design allows for the stacking of multiple cartridges in a magazine.

A-6. When the round is fired, the cartridge case assists in containing the burning propellant by expanding the cartridge case tightly to the chamber walls to provide rear obturation.

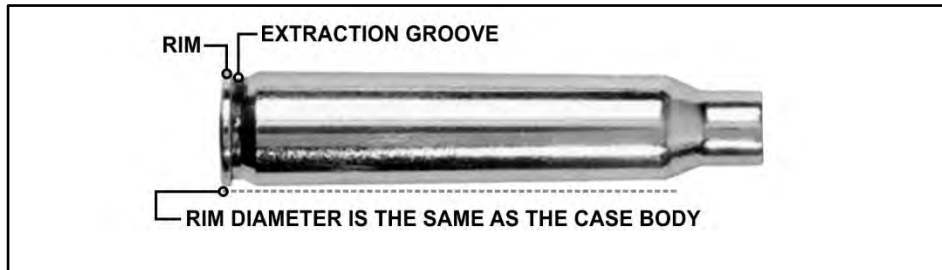

**Figure A-2. Cartridge case**

**Ammunition**

**PROPELLANT**

A-7. Cartridges are loaded with various propellant weights that impart sufficient velocity, within safe pressure, to obtain the required ballistic projectile performance. The propellants are either a single-base (nitrocellulose) or double-base (nitrocellulose and nitroglycerine) composition.

A-8. The propellant (see figure A-3) may be a single-cylindrical or multiple-perforation, a ball, or a flake design to facilitate rapid burning. Most propellants are coated to assist the control of the combustion rate. A final graphite coating facilitates propellant flow and eliminates static electricity in loading the cartridge.

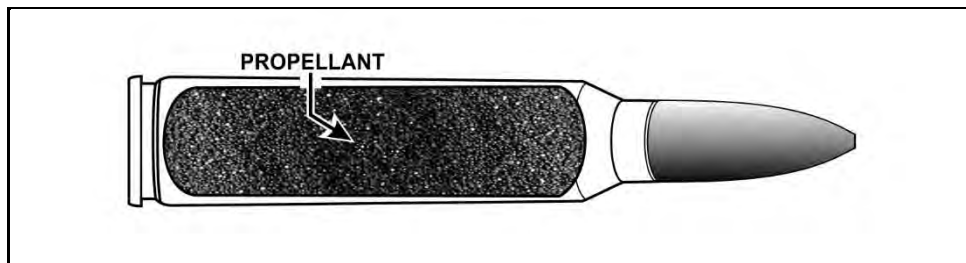

**Figure A-3. Propellant**

**Appendix A**

**PRIMER**

A-9. Center-fire small arms cartridges contain a percussion primer assembly. The assembly consists of a brass or gilding metal cup (see figure A-4). The cup contains a pellet of sensitive explosive material secured by a paper disk and a brass anvil.

A-10. The weapon firing pin striking the center of the primer cup base compresses the primer composition between the cup and the anvil. This causes the composition to explode. Holes or vents located in the anvil or closure cup allow the flame to pass through the primer vent, igniting the propellant.

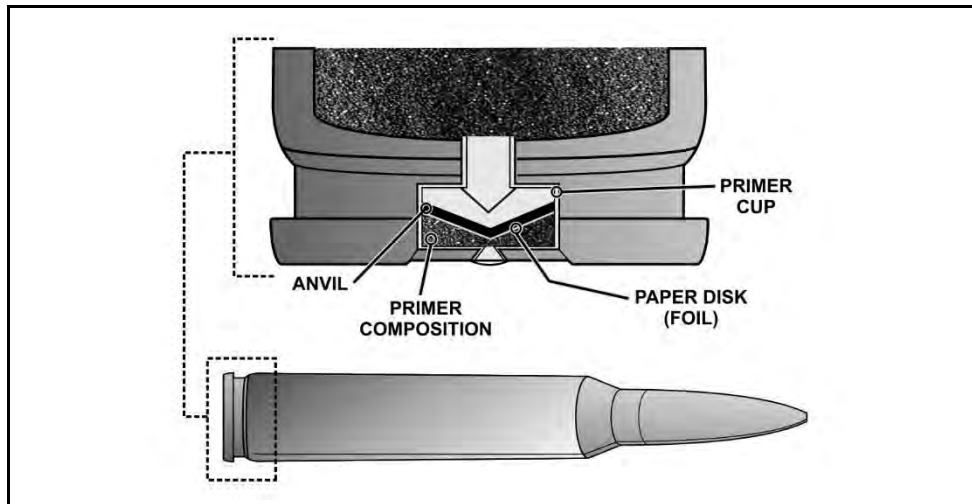

**Figure A-4. 5.56mm primer detail**

**Ammunition**

**BULLET**

A-11. The bullet is a cylindrically shaped lead or alloy projectile that engages with the rifling of the barrel. Newer projectiles consist of a copper slug with exposed steel penetrator, as with the M855A1. The bullets used today are either lead (lead alloy), or assemblies of a jacket and a lead or steel core penetrator. The lead used in lead-alloy bullets is combined with tin, antimony or both for bullet hardness. The alloying reduces barrel leading and helps prevent the bullet from striping (jumping) the rifling during firing.

A-12. Jacketed bullets (see figure A-5) are used to obtain high velocities and are better suited for semiautomatic and automatic weapons. A bullet jacket may be either gilding metal, gilding metal-clad steel, or copper plated steel. In addition to a lead or steel core, they may contain other components or chemicals that provide a terminal ballistic characteristic for the bullet type.

A-13. Some projectiles may be manufactured from plastic, wax, or plastic binder and metal powder, two or more metal powders, or various combinations based on the cartridge's use.

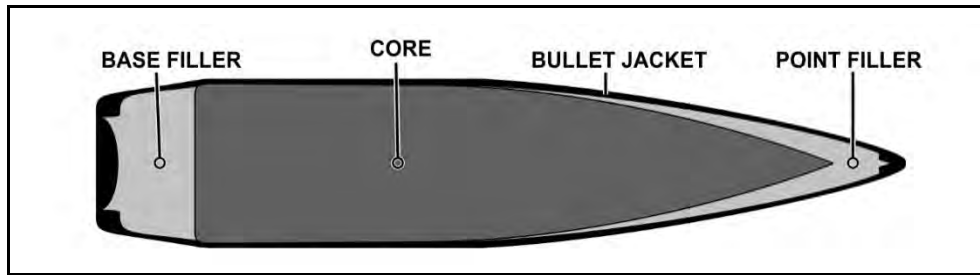

**Figure A-5. Bullet example, Armor-piercing cartridge**

**Appendix A**

**SMALL ARMS AMMUNITION TYPES**

A-14. There are seven types of SAA for the M4- and M16-series weapons that are used for training and combat. Each of these ammunition types provides a different capability and have specific characteristics. The following are the most common types of ammunition for the rifle and carbine:

**BALL**

A-15. The ball cartridge (see figure A-6) is intended for use in rifles and carbines against personnel and unarmored targets. The bullet, as designed for general purpose combat and training requirements, normally consists of a metal jacket and a lead slug.

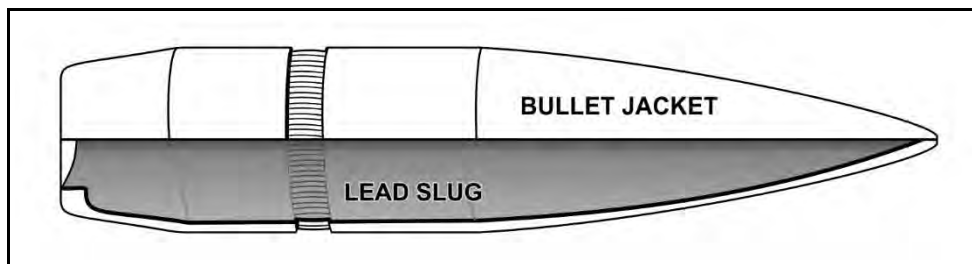

**Figure A-6. Ball cartridge**

**TRACER (TCR OR T)**

A-16. A tracer round contains a pyrotechnic composition in the base of the bullet to permit visible observation of the bullet's in-flight path or trajectory and point of impact. (See figure A-7) The pyrotechnic composition is ignited by the propellant when the round is fired, emitting a bright flame visible by the firer. Tracer rounds may also be used to pinpoint enemy targets to ignite flammable materials and for signaling purposes.

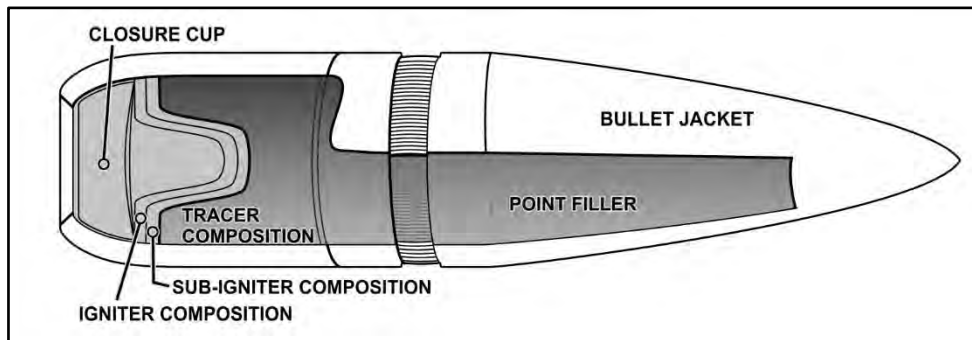
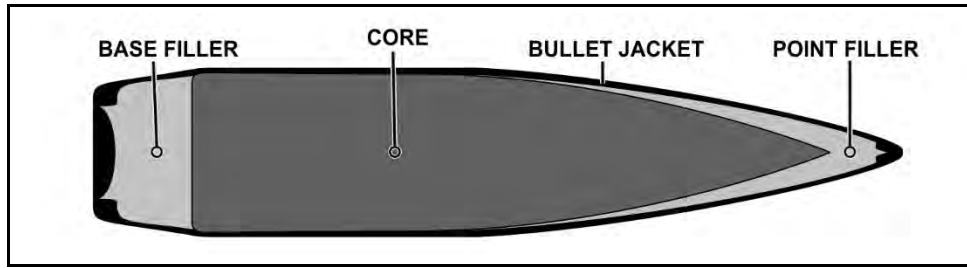

**Figure A-7. Ball with tracer cartridge**

**Ammunition**

**ARMOR PIERCING (AP)**

A-17. The armor-piercing cartridge (see figure A-8) is intended for use against personnel and light armored and unarmored targets, concrete shelters, and similar bullet-resistant targets. The bullet consists of a metal jacket and a hardened steel-alloy core. In addition, it may have a lead base filler and/or a lead point filler.



**Figure A-8. Armor-piercing cartridge**

**SHORT RANGE TRAINING AMMUNITION**

A-18. The short range training ammunition (SRTA) (see figure A-9) cartridges are designed for target practice where the maximum range is reduced for training purposes. This cartridge ballistically matches the ball cartridge out to 300 meters, and rapidly drops in velocity and accuracy. This allows for installations with restricted training range facilities to continue to operate with accurate munitions. This cartridge is also a preferred round when conducting training in a close quarters environment, like a shoot house or other enclosed training facility.

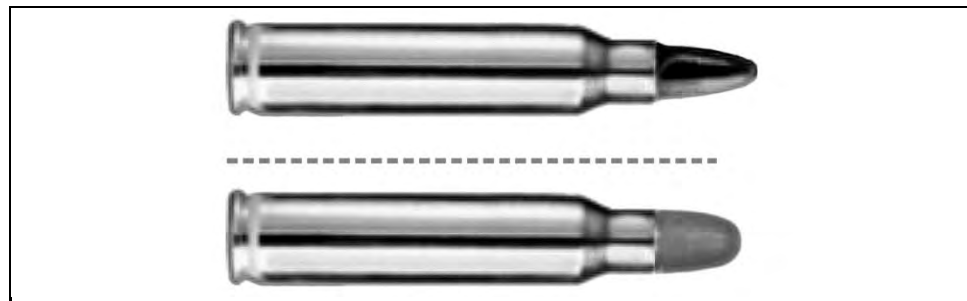

**Figure A-9. Short range training ammunition cartridge**

**Appendix A**

---

**BLANK (BLK)**

A-19. The blank cartridge (see figure A-10) is distinguished by the absence of a bullet or projectile. It is used for simulated fire, in training maneuvers, and for ceremonial purposes. These rounds consist of a roll crimp (knurl) or cannelure on the body of the case, which holds a paper wad in place instead of a projectile. Newer cartridges have rosette crimp (7 petals) and an identification knurl on the cartridge case.

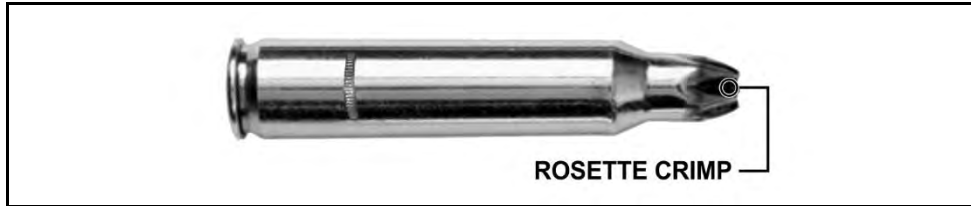

**Figure A-10. Blank cartridge**

**CLOSE COMBAT MISSION CAPABILITY KIT**

A-20. The close combat mission capability kit (CCMCK) cartridge (see figure A-11) is used for training purposes only.

A-21. The M4 carbine/M16 rifle conversion adapter kit provides utmost safety, in-service reliability and maintainability. The kit is easy to install with a simple exchange of the bolt. It adapts the host weapon to fire unlinked 5.56mm M1042 man-marking ammunition with the feel and function of live ammunition. The kit includes fail-safe measures to prevent the discharge of a standard “live” round.

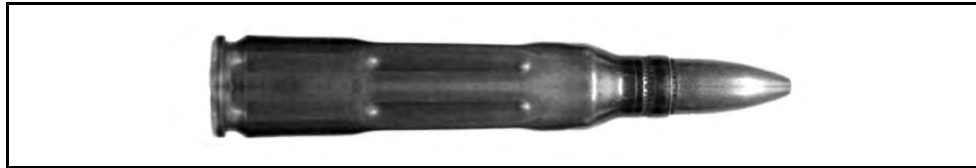

**Figure A-11. Close combat mission capability kit cartridge**

**Ammunition**

**DUMMY**

A-22. The dummy cartridge (see figure A-12) is used for practice in loading weapons and simulated firing to detect errors in employment skills when firing weapons. This round is completely inert and consists only of an empty cartridge case and ball bullet. Cartridge identification is by means of holes through the side of the case or longitudinal corrugations in the case and by the empty primer pocket.



**Figure A-12. Dummy cartridge**

**COLORS, MARKINGS, AND SYMBOLS**

A-23. Small arms ammunition is identifiable by color coding specification per type and intended use. Table A-1 describes the general color codes for all types of 5.56mm small arms ammunition. Table A-2 identifies the color code specifications that are applied to the tip of 5.56mm ammunition.

A-24. Markings stenciled or stamped on munitions or their containers include all information needed for complete identification.

A-25. Packaging and containers for small arms ammunition are clearly marked with standard NATO symbols identifying the contents of the package by type of ammunition, primary use, and packaging information. The most common NATO symbols are described according to Standardization Agreement (STANAG) (see table A-2 on page A-11).

A-26. Small arms ammunition (less than 20mm) is not color-coded under MIL-STD-709D. Marking standards for small arms ammunition are outlined in—









- TM 9-1305-201-20&P.
- TM 9-1300-200.

A-27. These publications describe the color coding system for small arms projectiles. The bullet tips are painted a distinctive color as a ready means of identification for the user. (Refer to TM 9-1300-200 for more information.)



**Appendix A**

**Table A-1. Small Arms Color Coding and Packaging Markings**





<b>Ammunition Type</b>	<b>Color Coding</b>	<b>Package Marking</b>
Ball	No Color or Green (M855)	
Tracer (TCR or T)	Orange Tip	
Armor Piercing (AP)	Black Tip	
Short Range Training Ammunition (STRA)	Blue	
Blank (BLK)	Cringed or Capped End	
Close Combat Mission Capabilities Kit (CCMCK) Dummy	Black Cartridge and Tip, or Perforated Cartridge	None
<b>Special Markings</b>	<b>Color Code</b>	<b>Package Marking</b>
NATO Standard		
Interchangeable - suitable for use in similar caliber NATO weapons		
Bandoleers - ammunition is packaged in bandoleers		
Clipped - ammunition is packaged in clips for use with a speed loader		

**5.56-MM AMMUNITION**

A-28. The following tables A-2 through A-10 on pages A-10 through A-18, will provide a brief description of the ten different types of commonly used 5.56mm ammunition for training and combat. Some types of 5.56mm ammunition will have more than one applicable Department of Defense Identification Code (DODIC); those DODICs are provided for the clarity and ease of the unit's ammunition resource manager.



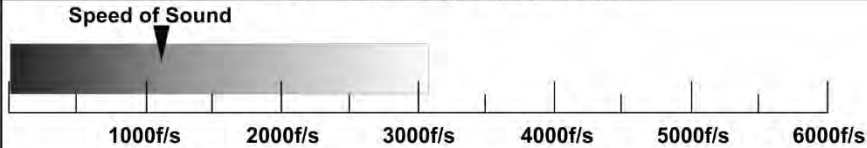

**Ammunition**

**Table A-2. 5-56mm, M855, Ball**

<b>Cartridge, 5.56mm, M855, Ball</b>			
DODIC:	A059	AA33	Green Tip
Model:	M855		
Type:	Ball		
Weight:	190 grain		
Length:	57.4 mm	2.26 in	
Color Code:		Green Tip	
Markings:			
<b>Case</b>			
Type:	Center Fire	Description:	5.56 x 45 mm
<b>Propellant</b>			
Type:	WC844	Double Base	Nitrocellulose, Nitroglycerine
Weight:	26.1 gr	0.06 oz	
<b>Primer</b>			
Type:	Center Fire, Percussion		
<b>Bullet</b>			
Type:	Ball, Copper Alloy Jacket		
Design:	Conical steel insert and lead antimony alloy cylindrical core copper alloy jacket.		
Weight:	62 gr	0.14 oz	
Length:	23 mm	0.906 in	
Tracer:	None		
<b>Characteristics</b>			
Chamber Pressure:	3792 bars	55000 psi	
Velocity:	922 m/sec	3025 ft/sec	2.69 mach
Kinetic Energy (EK)	1708 J	1260 FtLbsF	
<b>Velocity to Speed of Sound</b>			
Speed of Sound			
			
<b>Special Features</b>			
<p>The M16A2 Rifle was designed to fire M855 Ball to achieve commonality of ammunition at the small unit level. Chamber pressures generated by the M855 and the required barrel twist (1:7 or 32 calibers) make it unsuitable in the obsolete M16 and M16A1 weapons. The M855's steel insert is effective against most types of fabric body armor while its three-piece construction achieve good effects against unprotected personnel targets.</p>			

Appendix A

Table A-3. 5.56mm, M855A1, Enhanced Performance Round (EPR), Ball

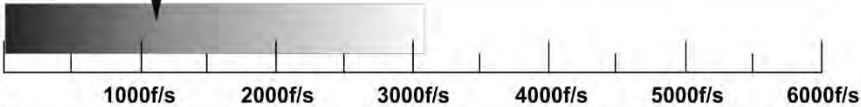
Cartridge, 5.56mm, M855A1, Ball, EPR			
DODIC:	AB57	AB58	Bronze Tip
Model:	M855A1 		
Type:	Ball, EPR		
Weight:	190 grain		
Length:	57.4 mm		
Color Code:		2.26 in Bronze Tip	
Markings:			
Case			
Type:	Center Fire	Description:	5.56 x 45 mm
Propellant			
Type:	WC844	Double Base	Nitrocellulose, Nitroglycerine
Weight:	28.1 gr	0.06 oz	
Primer			
Type:	Center Fire, Percussion		
Bullet			
Type:	Ball, EPR, Lead free slug (or core)		
Design:	Steel Penetrator encapsulated in a reverse gilded metal jacket.		
Weight:	62 gr	0.14 oz	
Length:	23 mm	0.906 in	
Tracer:	None		
Characteristics			
Chamber Pressure:	3792 bars	55000 psi	
Velocity:	960 m/sec	3150 ft/sec	2.8 mach
Kinetic Energy (Ek)	1851 J	1366 FtLbsF	
Velocity to Speed of Sound			
Speed of Sound			
			
1000f/s    2000f/s    3000f/s    4000f/s    5000f/s    6000f/s			
Special Features			
The M855A1's steel penetrator is effective against light armored targets while its three-piece construction maintains operational capabilities against unprotected personnel targets. The M855A1 enhances performance on hard targets/barriers. Improved propellant reduces muzzle flash. Optimized for use with the M4 series carbine for close quarters engagements.			



**Ammunition**

**Table A-4. 5.56mm, M856A1, Tracer**

<b>Cartridge, 5.56mm, M856A1, Tracer</b>			
DODIC:	A063		
Model:	M856A1		
Type:	Tracer		
Weight:	190 grain		
Length:	57.4 mm		
Color Code:			
Markings:			
<b>Case</b>			
Type:	Center Fire	Description:	5.56 x 45 mm
<b>Propellant</b>			
Type:	Wc844	Double Base	Nitrocellulose, Nitroglycerine
Weight:	24.7 gr	0.06 oz	
<b>Primer</b>			
Type:	Center Fire, Percussion		
<b>Bullet</b>			
Type:	Tracer		
Design:	Lead alloy core in copper alloy jacket with incendiary compound fill in hollow base.		
Weight:	63.7 gr	0.15 oz	
Length:	29.3 mm	1.154 in	
Tracer:	None		
<b>Characteristics</b>			
Chamber Pressure:	3792 bars	55000 psi	
Velocity:	875 m/sec	2870 ft/sec	2.55 mach
Kinetic Energy (Ek)	1580 J	1165 FtLbsF	
<b>Velocity to Speed of Sound</b>			
<b>Special Features</b>			
Because the M856 loses mass as it travels, it necessitates a 1:7 barrel twist to keep it stable in flight.			



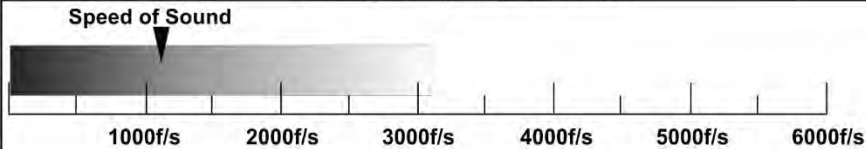

Appendix A

Table A-5. 5.56mm, Mk301, MOD 0, DIM Tracer

Cartridge, 5.56mm, Mk301 Mod 0, Dim Tracer			
DODIC	AB03	0	Violet Tip
Model:	Mk301 Mod 0 		
Type:	Dim Tracer		
Weight:	190 grain		
Length:	57.4 mm		
Color Code:		2.26 in Violet Tip	
Markings:			
Case			
Type:	Center Fire	Description:	5.56 x 45 mm
Propellant			
Type:	WC844	Double Base	Nitrocellulose, Nitroglycerine
Weight:	26.1 gr	0.06 oz	
Primer			
Type:	Center Fire, Percussion		
Bullet			
Type:	Dim Tracer, Copper Alloy Jacket		
Design:	Lead alloy core in copper alloy jacket with incendiary compound fill in a hollow case.		
Weight:	62 gr	0.14 oz	
Length:	23 mm	0.906 in	
Tracer:	Dim Tracer element		
Characteristics			
Chamber Pressure:	4047 bars	55000 psi	
Velocity:	922 m/sec	3025 ft/sec	2.69 mach
Kinetic Energy (Ek)	1708 J	1260 FtLbsF	
Velocity to Speed of Sound			
Speed of Sound 			
	1000f/s	2000f/s	3000f/s
			4000f/s
			5000f/s
			6000f/s
Special Features			
Low burning temperature of tracer mix produces IR light spectrum tracer effects, visible with use of night vision devices. Dim Tracer element consists of a barium nitrate composition, with tracer effective range to 900m. WC845S propellant provides flash suppression.			

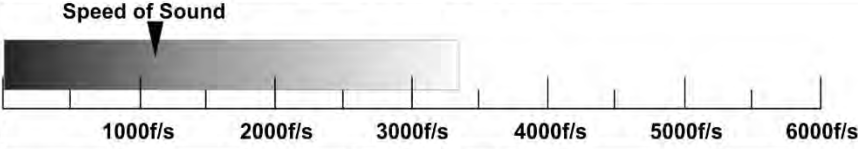

**Ammunition**

**Table A-6. 5.56mm, M995, Armor Piercing**

<b>Cartridge, 5.56mm, M995, Armor Piercing</b>			
DODIC	AA69		Black Tip
Model:	M995		
Type:	Armor Piercing		
Weight:	180 grain		
Length:	57.4 mm		
Color Code:		2.26 in Black Tip	
Markings:			
<b>Case</b>			
Type:	Center Fire	Description:	5.56 x 45 mm
<b>Propellant</b>			
Type:	WCR845	Double Base	Nitrocellulose, Nitroglycerine
Weight:	27.5 gr	0.06 oz	
<b>Primer</b>			
Type:	Center Fire, Berdan		
<b>Bullet</b>			
Type:	Armor Piercing, Tungsten-Cobalt core		
Design:	Tungsten-Cobalt core located by aluminum cup in copper alloy jacket		
Weight:	52 gr	0.12 oz	
Length:	29.3 mm	1.154 in	
Tracer:	None		
<b>Characteristics</b>			
Chamber Pressure:	3465 bars	55000 psi	
Velocity:	1013 m/sec	3324 ft/sec	2.95 mach
Kinetic Energy (Ek)	1729 J	1276 FtLbsF	
<b>Velocity to Speed of Sound</b>			
			
<b>Special Features</b>			
The M995 was designed for use in all U.S. 5.56mm weapons, it will penetrate 12mm of steel at 100m to defeat light armored vehicles and other barrier materials on the battlefield.			

Appendix A

Table A-7. 5.56mm, M862, Short Range Training Ammunition

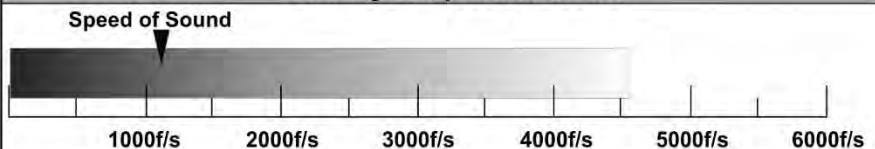
Cartridge, 5.56mm, M862, SRTA			
DODIC	AA68		
Model:	M862		
Type:	SRTA		
Weight:	108 grain		
Length:	57.4 mm		
Color Code:			
Markings:			
Case			
Type:	Center Fire	Description:	5.56 x 45 mm
Propellant			
Type:	0	Double Base	Nitrocellulose,
Weight:	gr	0 oz	Nitroglycerine
Primer			
Type:	Center Fire		
Bullet			
Type:	SRTA		
Design:	Plastic projectile		
Weight:	6.9 gr	0.02 oz	
Length:	29.3 mm	1.154 in	
Tracer:	None		
Characteristics			
Chamber Pressure:	2758 bars	40000 psi	
Velocity:	1379 m/sec	4525 ft/sec	4.02 mach
Kinetic Energy (Ek)	425 J	314 FtLbsF	
Velocity to Speed of Sound			
			
Special Features			
<p>The M862 is ballistically matched to standard M855 ball ammunition out to 25m, with a maximum range of 250m. M862 ammunition MUST be used with the M2 training bolt. This provides units the capability to conduct training on installations that have limited range facilities which require the use of reduced/decreased Surface Danger Zones.</p>			

**Ammunition**

**Table A-8. 5.56mm, M1037, Short Range Training Ammunition**

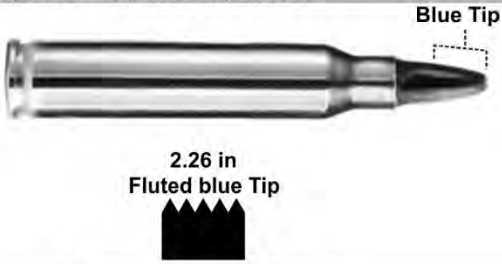
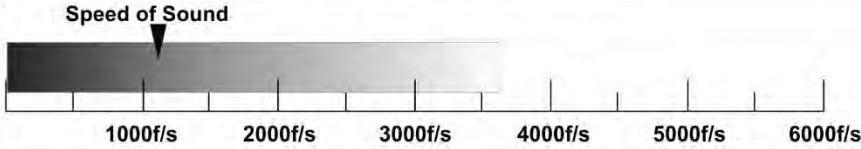
Cartridge, 5.56mm, M1037, SRTA			
DODIC:	AB67		
Model:	M1037		
Type:	SRTA		
Weight:	165 grain		
Length:	57.4 mm		
Color Code:			
Markings:			
Case			
Type:	Center Fire	Description:	5.56 x 45 mm
Propellant			
Type:	0	Double Base	Nitrocellulose, Nitroglycerine
Weight:	gr	0 oz	
Primer			
Type:	Center Fire		
Bullet			
Type:	SRTA, Frangible		
Design:	Copper, nylon and carbon fiber projectile		
Weight:	33 gr	0.08 oz	
Length:	29.3 mm	1.154 in	
Tracer:	None		
Characteristics			
Chamber Pressure:	2758 bars	40000 psi	
Velocity:	1097 m/sec	3600ft/sec	3.2 mach
Kinetic Energy (Ek)	1287J	950 FtLbsF	
Velocity to Speed of Sound			
			
Special Features			
<p>The M1037 is ballistically matched to standard M855 ball ammunition out to 100m, with a maximum range of less than 600m. M1037 ammunition DOES NOT require the use of the M2 training bolt. This provides units the capability to conduct training on installations that have limited range facilities which require the use of reduced/decreased Surface Danger Zones.</p>			





Appendix A

Table A-9. 5.56mm, M1042 Close Combat Mission Capability Kit

Cartridge, 5.56mm, M1042, Close Combat Mission Capability Kit			
DODIC:	AB09 (blue tip)	AB10 (red tip)	AB11 (yellow tip)
Model:	M1042		
Type:	CCMCK		
Weight:	94.86 grain		
Length:	57.4 mm		
Color Code:	2.26 in Blue, red, or yellow plastic tip		
Markings:			
<b>Case</b>			
Type:	Rim Fire	Description:	5.56 x 45 mm
<b>Propellant</b>			
Type:	0	Double Base	Nitrocellulose,
Weight:	gr	0 oz	Nitroglycerine
<b>Primer</b>			
Type:	Rim Fire		
<b>Bullet</b>			
Type:	CCMCK		
Design:	0		
Weight:	6.9 gr	0.02 oz	
Length:	29.3 mm	1.154 in	
Tracer:	None		
<b>Characteristics</b>			
Chamber Pressure:	0 bars	0 psi	
Velocity:	149 m/sec	488 ft/sec	0.43 mach
Kinetic Energy (Ek)	5 J	4 FtLbsF	
<b>Velocity to Speed of Sound</b>			
Speed of Sound			
<b>Special Features</b>			
<p>The CCMCK is a user installed weapons modification system used for short range force on force training. The M1042 is a low velocity marking ammunition that prevents the weapon from firing service ammunition. Fail-safe is achieved by utilizing a 3mm offset firing pin which will only work with the M1042 rim fire primer. In the event that a "Live" 5.56mm cartridge is chambered and the trigger is pulled, the conversion will offset.</p>			

**Ammunition**

**Table A-10. 5.56mm, M200, Blank**

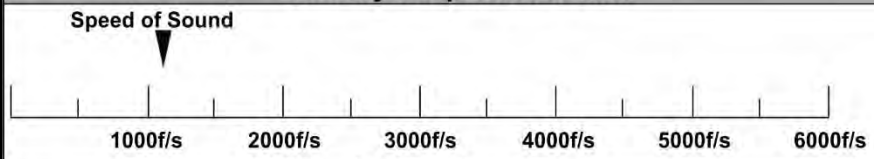
<b>Cartridge, 5.56mm, M200, Blank</b>			
DODIC:	A080		
Model:	M200		
Type:	Blank		
Weight:	107 grain		
Length:	48.3 mm		
Color Code:			
Markings:	 	1.902in Rosette Crimp	
<b>Case</b>			
Type:	Center Fire	Description:	5.56 x 45 mm
<b>Propellant</b>			
Type:	HPC 13	Double Base	Nitrocellulose, Nitroglycerine
Weight:	7 gr	0.02 oz	
<b>Primer</b>			
Type:	Center Fire, Berdan		
<b>Bullet</b>			
Type:	Blank, NA		
Design:	NA		
Weight:	NONE		
Length:	NA 0 in		
Tracer:	NA		
<b>Characteristics</b>			
Chamber Pressure:	0 bars	psi	
Velocity:	m/sec	ft/sec	0 mach
Kinetic Energy (Ek)	0	0	
<b>Velocity to Speed of Sound</b>			
			
<b>Special Features</b>			
<p>The M200 cartridge is designed for simulated firing in training exercises and for saluting purposes. The cartridge is identified by a rosette-crimp closure of the case mouth.</p>			

This page intentionally left blank.

## Appendix B

# Ballistics

Ballistics is the science of the processes that occur from the time a firearm is fired to the time when the bullet impacts its target. Soldiers must be familiar with the principles of ballistics as they are critical in understanding how the projectiles function, perform during flight, and the actions of the bullet when it strikes the intended target. The profession of arms requires Soldiers to understand their weapons, how they operate, their functioning, and their employment.

B-1. The flight path of a bullet includes three stages: the travel down the barrel, the path through the air to the target, and the actions the bullet takes upon impact with the target. These stages are defined in separate categories of ballistics; internal, external, and terminal ballistics.

### INTERNAL BALLISTICS

B-2. **Internal ballistics** – is the study of the propulsion of a projectile. Internal ballistics begin from the time the firing pin strikes the primer to the time the bullet leaves the muzzle. Once the primer is struck the priming charge ignites the propellant. The expanding gases caused by the burning propellant create pressures which push the bullet down the barrel. The bullet engages the lands and grooves (rifling) imparting a spin on the bullet that facilitates stabilization of the projectile during flight. Internal ballistics ends at shot exit, where the bullet leaves the muzzle. (See figure B-1.)

Appendix B

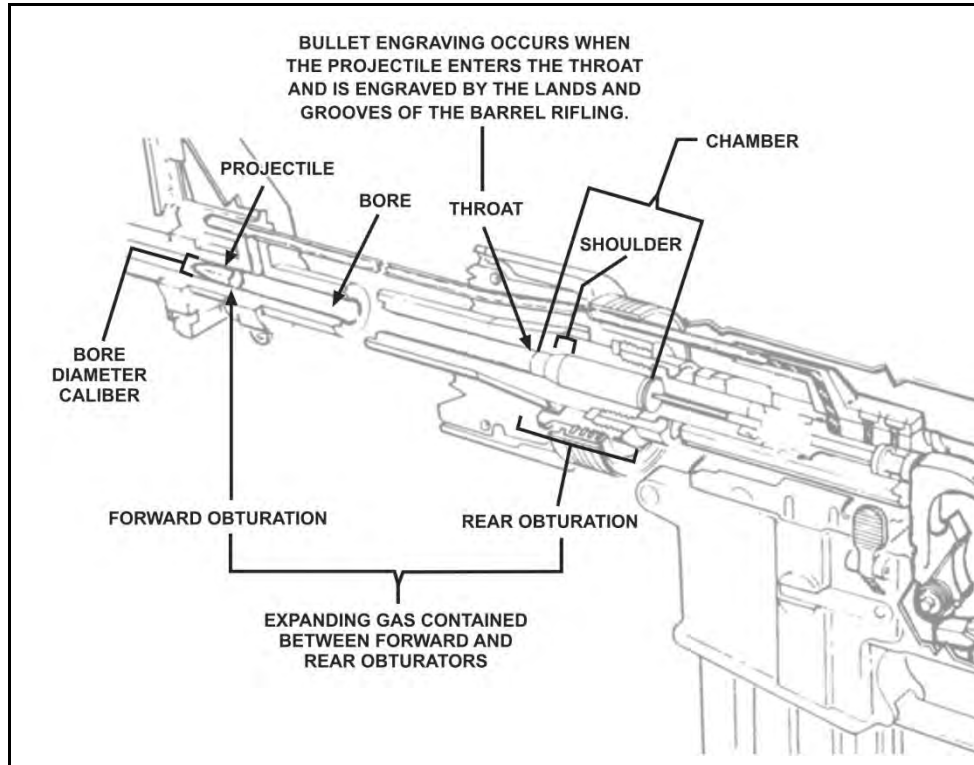

Figure B-1. Internal ballistic terms

B-3. Several key terms are used when discussing the physical actions of internal ballistics —

- **Bore** – the interior portion of the barrel forward of the chamber.
- **Chamber** – the part of the barrel that accepts the ammunition for firing.
- **Grain (gr)** – a unit of measurement of either a bullet or a projectile. There are 7000 grains in a pound, or 437.5 grains per ounce.
- **Pressure** – the force developed by the expanding gasses generated by the combustion (burning) of the propellant. Pressure is measure in pounds per square inch (psi).
- **Shoulder** – the area of the chamber that contains the shoulder, forcing the cartridge and projectile into the entrance of the bore at the throat of the barrel.
- **Muzzle** – the end of the barrel.
- **Throat** – the entrance to the barrel from the chamber. Where the projectile is introduced to the lands and grooves within the barrel.

## EXTERNAL BALLISTICS

B-4. **External ballistics** is the study of the physical actions and effects of gravity, drag, and wind along the projectile's flight to the target. It includes only those general physical actions that cause the greatest change to the flight of a projectile. (See figure B-2.) External ballistics begins at shot exit and continues through the moment the projectile strikes the target.

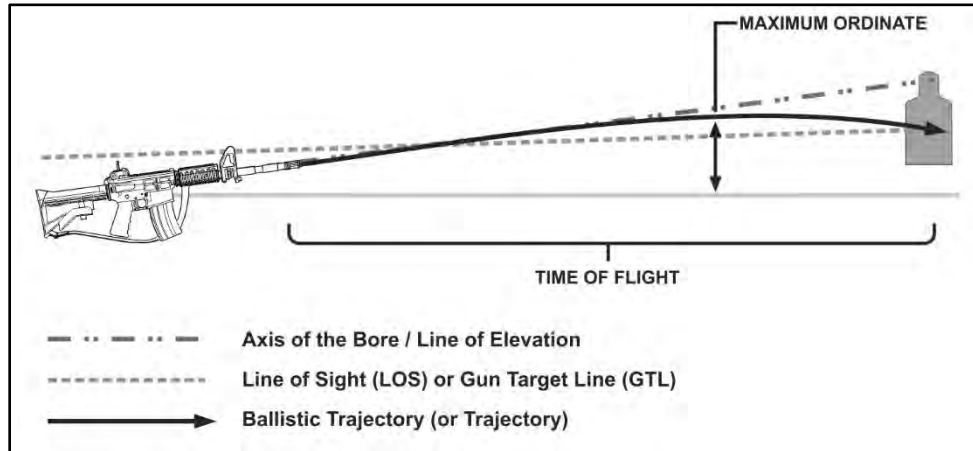

Figure B-2. External ballistic terms

B-5. The following terms and definitions are used to describe the actions or reactions of the projectile during flight. This terminology is standard when dealing with any weapon or weapon system, regardless of caliber. (See figure B-3.)

- **Axis of the bore** (Line of Bore) – the line passing through the center of the bore or barrel.
- **Line of sight (LOS) or gun target line (GTL)** – a straight line between the sights or optics and the target. This is never the same as the axis of the bore. The LOS is what the Soldier sees through the sights and can be illustrated by drawing an imaginary line from the firer's eye through the rear and front sights out to infinity. The LOS is synonymous with the GTL when viewing the relationship of the sights to a target.
- **Line of elevation (LE)** – the angle represented from the ground to the axis of the bore.
- **Ballistic trajectory** – the path of a projectile when influenced only by external forces, such as gravity and atmospheric friction.
- **Maximum ordinate** – the maximum height the projectile will travel above the line of sight on its path to the point of impact.
- **Time of flight** – the time taken for a specific projectile to reach a given distance after firing.

Appendix B

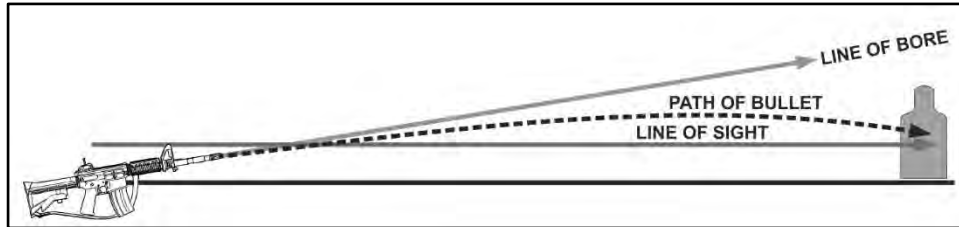

Figure B-3. Trajectory

- **Jump** – vertical jump in an upward and rearward direction caused by recoil. Typically, it is the angle, measured in mils, between the line of departure and the line of elevation.
- **Line of departure (LD)** – the line the projectile is on at shot exit.
- **Muzzle** – the end of the barrel.
- **Muzzle velocity or velocity** – the velocity of the projectile measured at shot exit. Muzzle velocity decreases over time due to air resistance. For small arms ammunition, velocity (V) is represented in feet per second (f/s).
- **Twist rate** – the rotation of the projectile within the barrel of a rifled weapon based on the distance to complete one revolution. The twist rate relates to the ability to gyroscopically spin-stabilize a projectile on rifled barrels, improving its aerodynamic stability and accuracy. The twist rate of the M4- or M16-series weapon is a right hand, one revolution in every seven inches of barrel length (or R 1:7 inches).
- **Shot exit** – the moment the projectile clears the muzzle of the barrel, where the bullet is not supported by the barrel.
- **Oscillation** – the movement of the projectile in a circular pattern around its axis during flight.
- **Drift** – the lateral movement of a projectile during its flight caused by its rotation or spin.
- **Yaw** – a deviation from stable flight by oscillation. This can be caused by cross wind or destabilization when the projectile enters or exits a transonic stage.
- **Grain (gr)** – a unit of measurement of either a bullet or a propellant charge. There are 7000 grains in a pound, or 437.5 grains per ounce.
- **Pressure** – the force developed by the expanding gases generated by the combustion (burning) of the propellant. For small arms, pressure is measured in pounds per square inch (psi).
- **Gravity** – the constant pressure of the earth on a projectile at a rate of about 9.8 meters per second squared, regardless of the projectile's weight, shape or velocity. Commonly referred to as bullet drop, gravity causes the projectile to drop from the line of departure. Soldiers must understand the effects of gravity on the projectile when zeroing as well as how it applies to determining the appropriate hold-off at ranges beyond the zero distance.

---

**Ballistics**

---

- **Drag (air resistance)** – the friction that slows the projectile down while moving through the air. Drag begins immediately upon the projectile exiting the barrel (shot exit). It slows the projectile’s velocity over time, and is most pronounced at extended ranges. Each round has a ballistic coefficient (BC) that is a measurement of the projectile’s ability to minimize the effects of air resistance (drag) during flight.
- **Trajectory** – the path of flight that the projectile takes upon shot exit over time. For the purposes of this manual, the trajectory ends at the point of impact.
- **Wind** – has the greatest variable effect on ballistic trajectories. The effects of wind on a projectile are most noticeable in three key areas between half and two-thirds the distance to the target:
  - **Time (T)** – the amount of time the projectile is exposed to the wind along the trajectory. The greater the range to target, the greater time the projectile is exposed to the wind’s effects.
  - **Direction** – the direction of the wind in relation to the axis of the bore. This determines the direction of drift of the projectile that should be compensated.
  - **Velocity (V)** – the speed of the wind during the projectile’s trajectory to the target. Variables in the overall wind velocity affecting a change to the ballistic trajectory include sustained rate of the wind and gust spikes in velocity.

## TERMINAL BALLISTICS

B-6. Terminal ballistics is the science of the actions of a projectile from the time it strikes an object until it comes to rest (called terminal rest). This includes the terminal effects that take place against the target.

- **Kinetic Energy ( $E_k$ )** – a unit of measurement of the delivered force of a projectile. Kinetic energy is the delivered energy that a projectile possesses due to its mass and velocity at the time of impact. Kinetic energy is directly related to the *penetration capability* of a projectile against the target.
- **Penetration** – the ability or act of a projectile to enter a target’s mass based on its delivered kinetic energy. When a projectile strikes a target, the level of penetration into the target is termed the impact depth. The impact depth is the distance from the point of impact to the moment the projectile stops at its terminal resting place. Ultimately, the projectile stops when it has transferred its momentum to an equal mass of the medium (or arresting medium).

B-7. Against any target, penetration is the most important terminal ballistic consideration. Soldiers must be aware of the penetration capabilities of their ammunition against their target, and the most probable results of the terminal ballistics.

B-8. The 5.56mm projectile’s purpose is to focus the largest amount of momentum (energy) on the smallest possible area of the target to achieve the greatest penetration. They are designed to resist deformation on impact to enter the target’s mass. The steel



## **Appendix B**

---

tip of the penetrator allows for reduced deformation through light skin armor or body armor, and the heavier steel penetrator allows for increased soft tissue damage.

### **ACTIONS AFTER THE TRIGGER SQUEEZE**

B-9. Once the trigger is squeezed, the ballistic actions begin. Although not all ammunition and weapons operate in the same manner, the following list describes the general events that occur on the M4- and M16-series weapons when the trigger is squeezed.

- The hammer strikes the rear of the firing pin.
- The firing pin is pushed forward, striking the cartridge percussion primer assembly.
- The primer is crushed, pushing the primer composition through the paper disk, and on to the anvil, detonating the primer composition.
- The burning primer composition is focused evenly through the primer cup vent hole, igniting the propellant.
- The propellant burns evenly within the cartridge case.
- The cartridge case wall expand from the pressure of the burning propellant, firmly locking the case to the chamber walls.
- The expanded cartridge case, held firmly in place by the chamber walls and the face of the bolt provide rear obturation, keeping the burning propellant and created expanding gasses in front of the cartridge case.
- The projectile is forced by the expanding gasses firmly into the lands and grooves at the throat of the bore, causing engraving.
- Engraving causes the scoring of the softer outer jacket of the projectile with the lands and grooves of the bore. This allows the projectile to spin at the twist rate of the lands and grooves, and provides a forward obturation seal. The forward obturation keeps the expanding gasses behind the projectile in order to push it down the length of the barrel.
- As the propellant continues to burn, the gasses created continue to seek the path of least resistance. As the cartridge case is firmly seated and the projectile is moveable, the gas continues to exert its force on the projectile.
- Once the projectile passes the gas port on the top of the barrel, a small amount of gas is permitted to escape from propelling the projectile. This escaping gas is directed up through the gas port and rearward through the gas tube, following the path of least resistance. The diameter of the gas port limits the amount of gas allowed to escape.
- As the end of the projectile leaves the muzzle, it is no longer supported by the barrel itself. Shot exit occurs.
- Upon shot exit, most of the expanding and burning gasses move outward and around the projectile, causing the muzzle flash.
- At shot exit, the projectile achieves its maximum muzzle velocity. From shot exit until the projectile impacts an object, the projectile loses velocity at a steady rate due to air resistance.

---

**Ballistics**

---

- As the round travels along its trajectory, the bullet drops consistently by the effects of gravity.
- As the actual line of departure is an elevated angle from the line of sight, the projectile appears to rise and then descend. This rise and fall of the projectile is the trajectory.
- The round achieves the highest point of its trajectory typically over half way to the target, depending on the range to target. The high point is called the round's maximum ordinate or *max ord*.
- From the max ord, the projectile descends into the target.
- The round strikes the target at the point of impact, which, depending on the firing event, may or may not be the desired point of impact, and is seldom the point of aim.

---

*Note.* The point of aim and point of impact only occur twice during the bullet's path to the target at distance; once when the trajectory crosses the line of sight approximately 25 meters from the muzzle, and again at the zero distance (300 meters for the Army standard zero).

---

- Once the projectile strikes a target or object, it delivers its kinetic energy (force) at the point of impact.
- Terminal ballistics begin.

B-10. Once terminal ballistics begin, no bullets follow the same path or function. Generally speaking, the projectile will penetrate objects where the delivered energy (mass times velocity squared, divided by 2) is greater than the mass, density, and area of the target at the point of the delivered force. There are other contributing factors, such as the angle of attack, yaw, oscillation, and other physical considerations that are not included in this ballistic discussion.

### **STRUCTURE PENETRATION**

B-11. The following common barriers in built-up areas can prevent penetration by a 5.56-mm round fired at less than 50 meters (M855) including:

- Single row sandbags.
- A 2-inch thick concrete wall (not reinforced with rebar or similar item).
- A 55-gallon drum filled with water or sand.
- A metal ammunition can filled with sand.
- A cinder block filled with sand (the block may shatter).
- A plate glass windowpane at a 45-degree angle (glass fragments will be thrown behind the glass).
- A brick veneer.

---

*Note.* The M855A1 enhanced performance round (EPR) has increased capabilities for barrier penetration compared with M855 as shown above.

---

## Appendix B

---

B-12. Although most structural materials repel single 5.56-mm rounds, continued and concentrated firing can breach (penetrate through) some typical urban structures.

B-13. The best method for breaching a masonry wall is by firing short bursts in a U-shaped pattern. The distance from the firer to the wall should be minimized for best results—ranges as close as 25 meters are relatively safe from ricochet.

B-14. Ball ammunition and armor-piercing rounds produce almost the same results, but are more likely to ricochet to the sides and rearward back at the firer (called spit-back).

---

*Note.* Soldiers must ensure the appropriate level of personal protective equipment is worn when conducting tactical and collective tasks, particularly at ranges less than 50 meters.

---

B-15. The 5.56-mm round can be used to create either a loophole (about 7 inches in diameter) or a breach hole (large enough for a man to enter). When used against reinforced concrete, the M16 rifle and M249 cannot cut the reinforcing bars.

### SOFT TISSUE PENETRATION

B-16. A gunshot wound, or ballistic trauma, is a form of physical damage sustained from the entry of a projectile. The degree of tissue disruption caused by a projectile is related to the size of the cavities created by the projectile as it passes through the target's tissue. When striking a personnel target, there are two types of cavities created by the projectile; permanent and temporary wound cavities.

#### Permanent Wound Cavity

B-17. The permanent cavity refers specifically to the physical hole left in the tissues of soft targets by the pass-through of a projectile. It is the total volume of tissue crushed or destroyed along the path of the projectile within the soft target.

B-18. Depending on the soft tissue composition and density, the tissues are either elastic or rigid. Elastic organs stretch when penetrated, leaving a smaller wound cavity. Organs that contain dense tissue, water, or blood are rigid, and can shatter from the force of the projectile. When a rigid organ shatters from a penetrating bullet, it causes massive blood loss within a larger permanent wound cavity. Although typically fatal, striking these organs may not immediately incapacitate the target.

#### Temporary Wound Cavity

B-19. The temporary wound cavity is an area that surrounds the permanent wound cavity. It is created by soft, elastic tissues as the projectile passes through the tissue at greater than 2000 feet per second. The tissue around the permanent cavity is propelled outward (stretched) in an almost explosive manner from the path of the bullet. This forms a temporary recess or cavity 10 to 12 times the bullet's diameter.

B-20. Tissue such as muscle, some organs, and blood vessels are very elastic and can be stretched by the temporary cavity with little or no damage and have a tendency to absorb the projectile's energy. The temporary cavity created will slowly reduce in size

---

**Ballistics**

---

over time, although typically not returning completely to the original position or location.

---

*Note.* Projectiles that do not exceed 2000 feet per second velocity on impact do not provide sufficient force to cause a temporary cavity capable of incapacitating a threat.

---

B-21. The extent of the cavitation (the bullet's creation of the permanent and temporary cavities) is related to the characteristics of the projectile:

- **Kinetic energy ( $E_k$ )** – the delivered mass at a given velocity. Higher delivered kinetic energy produces greater penetration and tissue damage.
- **Yaw** – any yaw at the point of impact increases the projectile's surface area that strikes the target, decreasing kinetic energy, but increasing the penetration and cavity size.
- **Deformation** – the physical changes of the projectile's original shape and design due to the impact of the target. This increases the projectile's surface area and the size of the cavity created after penetration.
- **Fragmentation** – the fracturing of a projectile into multiple pieces or sub-projectiles. The multiple paths of the fragmented sub-projectiles are unpredictable in size, velocity, and direction. The bullet jacket, and for some types of projectiles, the lead core, fracture creating small, jagged, sharp edged pieces that are propelled outward with the temporary cavity. Fragments can sever tissue, causing large, seemingly explosive-type. Bone fragments caused by the bullet's strike can have the same effect.
- **Tumbling** – the inadvertent end-over-end rotation of the projectile. As a projectile tumbles as it strikes the target, the bullet travels through the tissues with a larger diameter. This causes a more severe permanent cavity as it passes through the soft tissue. A tumbling projectile can change direction erratically within the body due to its velocity and tendency to strike dense material with a larger surface area.

B-22. Once inside the target, the projectile's purpose is to destroy soft tissues with fragmentation. The ball ammunition is designed to not flatten or expand on impact, which would decrease velocity and delivered energy. For the M855-series cartridge, the penetrator tends to bend at the steel-core junction, fracture the weaker jacketed layer, and fragment into pieces when striking an object.

## **Appendix B**

---

### **Incapacitation**

B-23. Incapacitation with direct fire is the act of ballistically depriving a target of the ability, strength, or capability to continue its tactical mission. To assist in achieving the highest probability of incapacitation with a single shot, the projectile is designed with the ability to tumble, ricochet, or fragment after impact.

B-24. The projectile or its fragments then must hit a vital, blood-bearing organ or the central nervous system to effectively incapacitate the threat. The projectile's limited fragmentation potential after entry maximizes the soft tissue damage and increases the potential for rapid incapacitation.

### **Lethal Zones**

B-25. The Soldier's primary point of aim at any target by default is center of visible mass. This allows for a tolerance that includes the greatest margin of error with the highest probability of a first round hit. The combat conditions may require more precise fires at partially exposed targets or targets that require immediate incapacitation.

B-26. Ideally, the point of aim is anywhere within a primary switch area. This point will maximize the possibility of striking major organs and vessels, rendering a clean, one-shot kill (see figure B-4.)

**Ballistics**

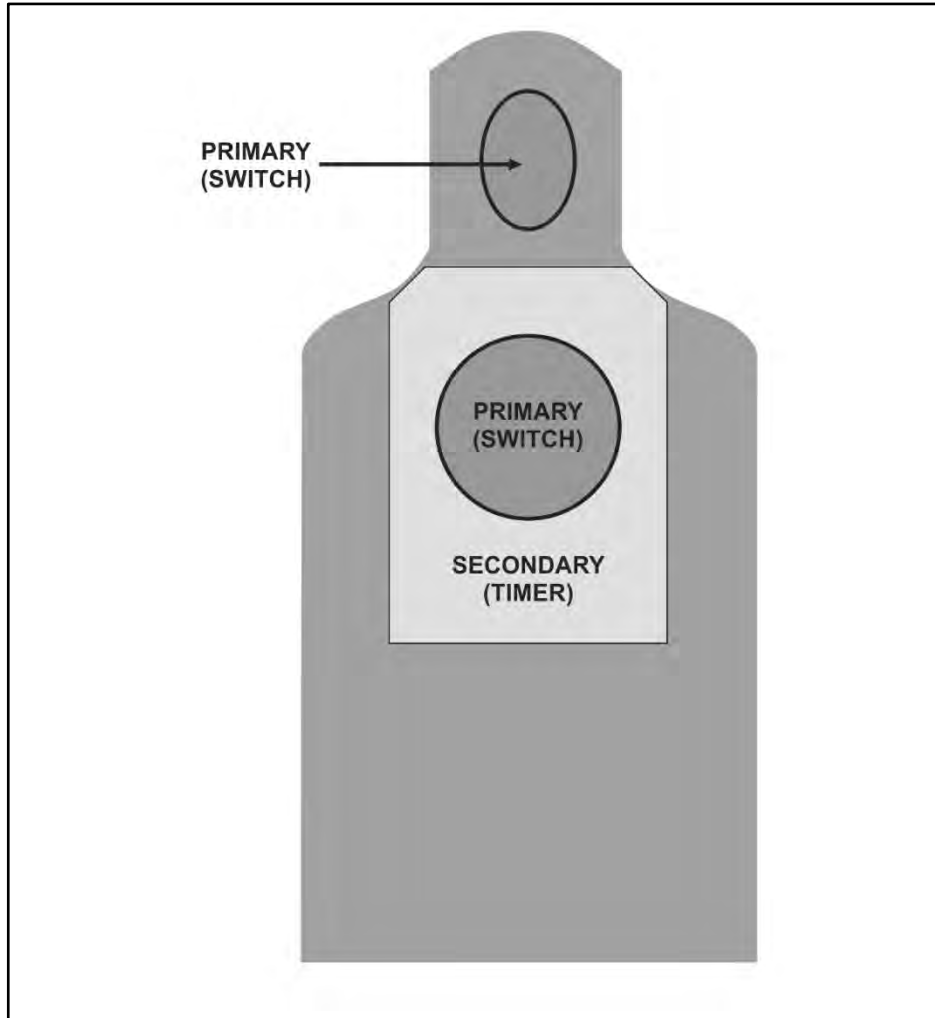

**Figure B-4. Lethal zone example**

B-27. Shots to the head should be weighed with caution. The head is the most frequently moved body part and are the most difficult to hit with precision. Shots to other exposed body parts, such as the pelvic area, should be considered for the shot.

B-28. Shots to the pelvic area are used when the target is not completely visible or when the target is wearing body armor that prevents the Soldier from engaging the primary zone. This area is rich in large blood vessels and a shot here has a good possibility of impeding enemy movement by destroying the pelvic or hitting the lower spine.

- Circuitry shots (switches).
- Hydraulic shots (timers).

**Appendix B**

---

**Circuitry Shots (Switches)**

B-29. Circuitry shots, or “switches,” are strikes to a target that deliver its immediate incapacitation. Immediate incapacitation is the sudden physical or mental inability to initiate or complete any physical task. To accomplish this, the central nervous system must be destroyed by hitting the brain or spinal column. All bodily functions and voluntary actions cease when the brain is destroyed and if the spinal column is broken, all functions cease below the break.

**Hydraulic Shots (Timer)**

B-30. Hydraulic shots, or “timers,” are impacts on a target where immediate incapacitation is not guaranteed. These types of ballistic trauma are termed “timers” as that after the strike of the bullet, the damage caused requires time for the threat to have sufficient blood loss to render it incapacitated. Hydraulic shots, although ultimately lethal, allow for the threat to function in a reduced capacity for a period of time.

B-31. For hydraulic shots to eliminate the threat, they must cause a 40 percent loss of blood within the circulatory system. If the shots do not disrupt that flow at a rapid pace, the target will be able to continue its mission. Once two (2) liters of blood are lost, the target will transition into hypovolemic shock and become incapacitated.

## Appendix C

# Complex Engagements

This appendix provides detailed information on the calculations for determining *deliberate* holds for complex engagements and various engagement techniques. It is designed for the advanced shooter; however, all Soldiers should be familiar with the contents of the appendix in order to build their mastery and proficiency with their individual weapon.

C-1. A complex engagement includes any shot that cannot use the *CoVM* as the point of aim to ensure a target hit. Complex engagements require a Soldier to apply various points of aim (called hold, hold-off, or holds) to successfully defeat the threat.

C-2. This appendix builds upon the concepts discussed in Chapter 7, Aim, and only include topics specific to deliberate hold determinations. These topics are:

- **Target conditions:**
  - Range to target.
  - Moving targets.
  - Oblique targets.
- **Environmental conditions:**
  - Wind.
  - Angled firing.
- **Compound conditions:**

C-3. Each of these firing conditions may require the Soldier to determine an appropriate aim point that is not the CoVM. During any complex engagement, the Soldier serves as the ballistic computer during the shot process. The hold represents a refinement or alteration of the center of visible mass point of aim at the target to counteract certain conditions during a complex engagement for—

- Range to target.
- Lead for targets based on their direction and speed of movement.
- Counter-rotation lead required when the Soldier is moving in the opposite direction of the moving target.
- Wind speed, direction, and duration between the shooter and the target at ranges greater than 300 meters.
- Greatest lethal zone presented by the target to provide the most probable point of impact to achieve immediate incapacitation.

C-4. The Soldier will apply the appropriate aim (hold) based on the firing instances presented. Hold determinations will be discussed in two formats; immediate and deliberate.



**Appendix C**

**TARGET CONDITIONS**

C-5. Soldiers must consider several aspects of the target to apply the proper point of aim on the target. The target’s posture, or how it is presenting itself to the shooter, consists of—

- Range to target.
- Nature of the target.
- Nature of the terrain (surrounding the target).

**RANGE TO TARGET**

C-6. Rapidly determining an accurate range to target is critical to the success of the Soldier at mid and extended ranges. There are several range determination methods shooters should be confident in applying to determine the proper hold-off for pending engagements.

**Deliberate Range Determination**

C-7. The deliberate methods afford the shooter a reliable means of determining the range to a given target; however, these methods require additional time. (See figure C-1.) With practice and experience, the time to determine the range with these methods is reduced significantly. The various methods of deliberate range determination are:

- Reticle relationship (mil or MOA).
- Recognition method.
- Bracketing method.
- Halving method.

RANGE ESTIMATION	MIL RELATION FORMULA
<p style="text-align: center;">SIZE OF OBJ <u>IN INCHES!</u> X 25.4 = <b>Constant</b>.</p> <p>Divide the <b>Constant</b> by SIZE OF OBJ <u>IN MILS</u> to determine the range to target.</p> <p style="text-align: center;"><b>EXAMPLE</b></p> <p><b>67 inches</b> X 25.4 = 1701.8 rounded to the nearest whole number - 1702.</p> <div style="border: 1px solid black; padding: 2px; width: fit-content; margin-left: auto; margin-right: auto;"> <p style="margin: 0;">This is the constant.</p> </div> <p><b>Constant</b> (1702) divided by 2.5 Mils = 681, or 681 meters to the target.</p> <div style="border: 1px solid black; padding: 5px; width: fit-content; margin-left: auto; margin-right: auto;"> <p style="margin: 0;">This number comes from your own perception of an object measured with a mil scale from an optic, or a pair of binoculars. The number is whatever you observe it to be.</p> </div>	

**Figure C-1. Mil Relation Formula example**

**Complex Engagements**

***Reticle Relationship Method***

C-8. With this method, shooters use their aiming device’s reticle to determine the range to target based on standard target information. To use the appearance of objects method based on how they align to an aiming device’s reticle, shooters must be familiar with the sizes and details of personnel and equipment at known distances as shown in figure C-2.

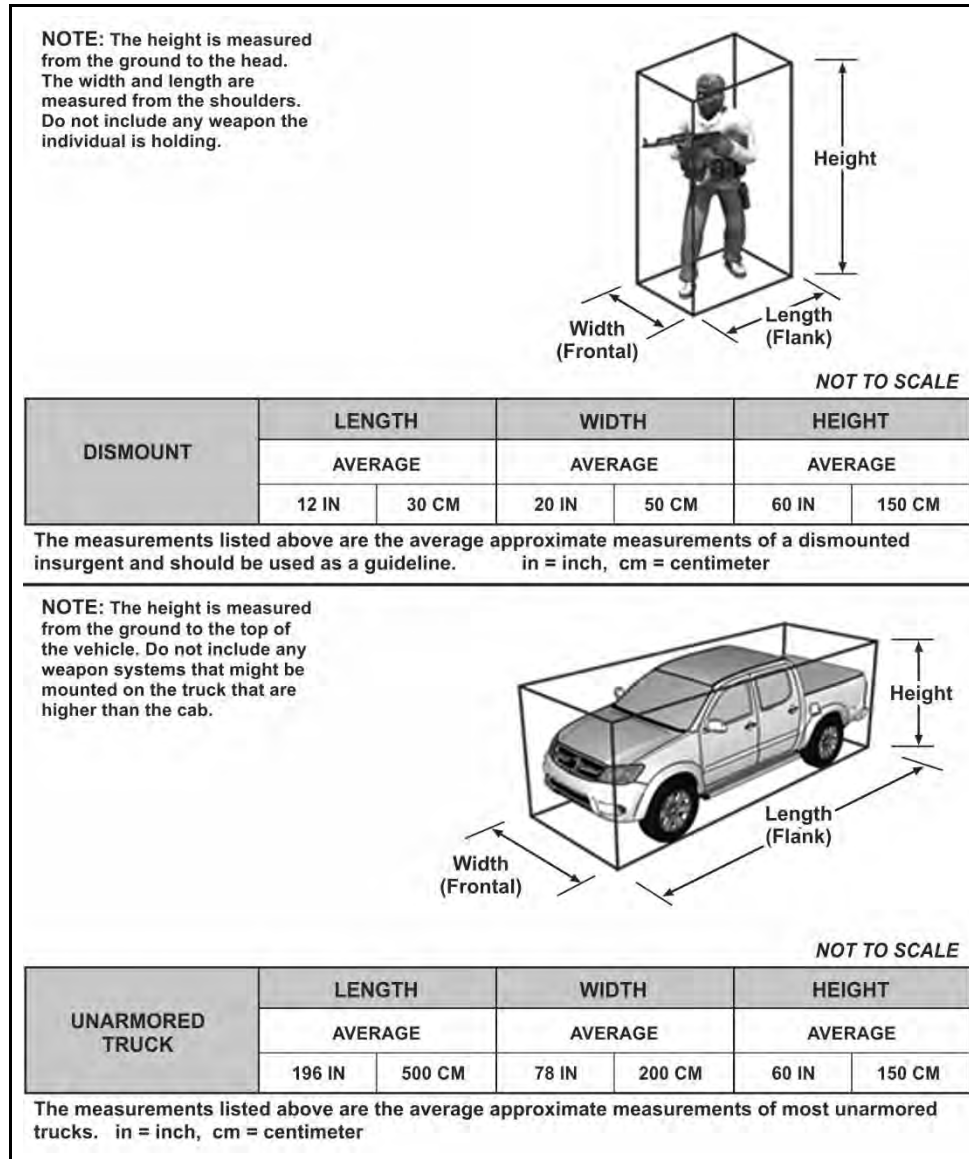

**Figure C-2. Standard dismount threat dimensions example**

**Appendix C**

C-9. Knowing the standard dimensions to potential targets allows for the Soldier to assess those dimensions using the aiming device's reticle. The Soldier will apply the mil or MOA relationship as they pertain to the aiming device and the target. Figure C-3 and figure C-4 on page C-5, show various reticle relationship examples.

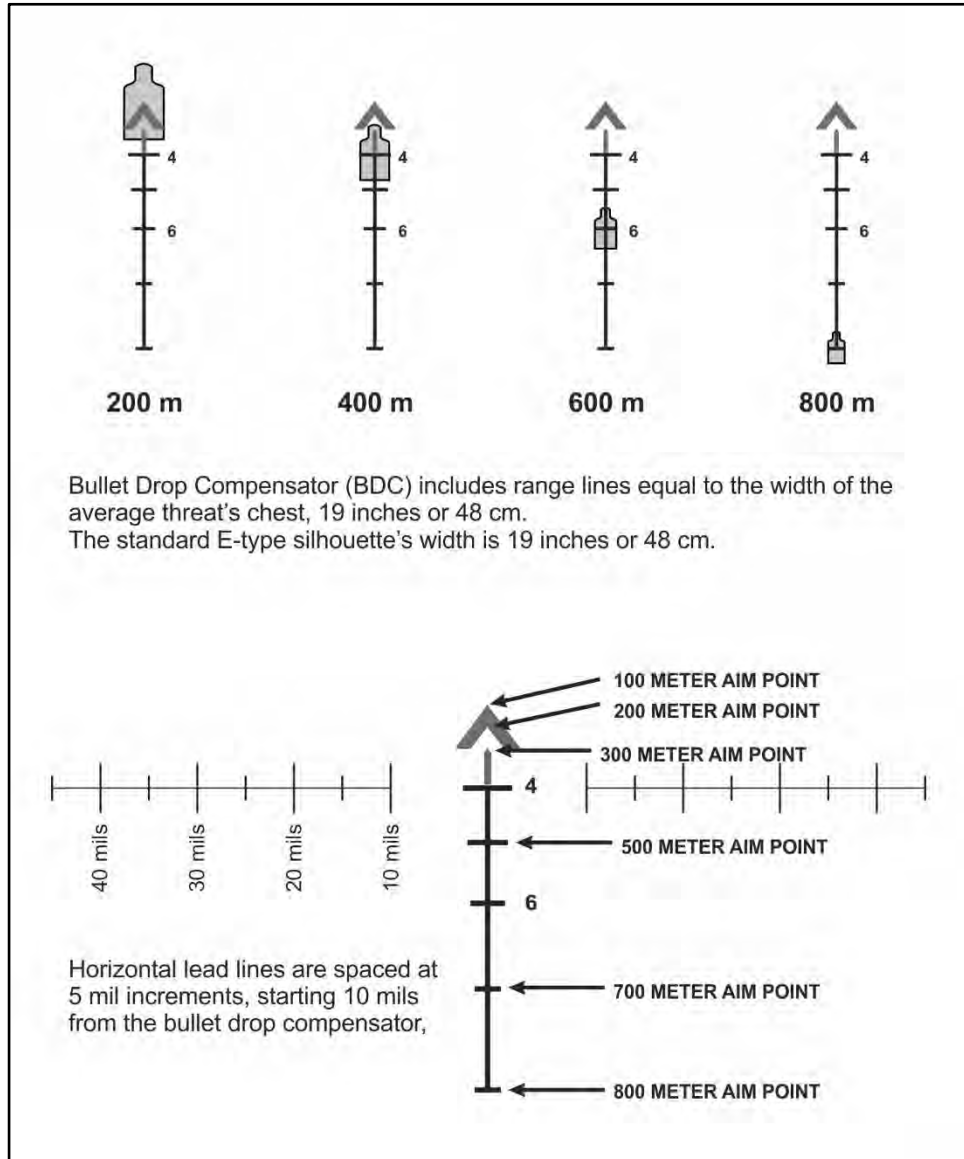

**Figure C-3. RCO range determination using the bullet drop compensator reticle**

Complex Engagements

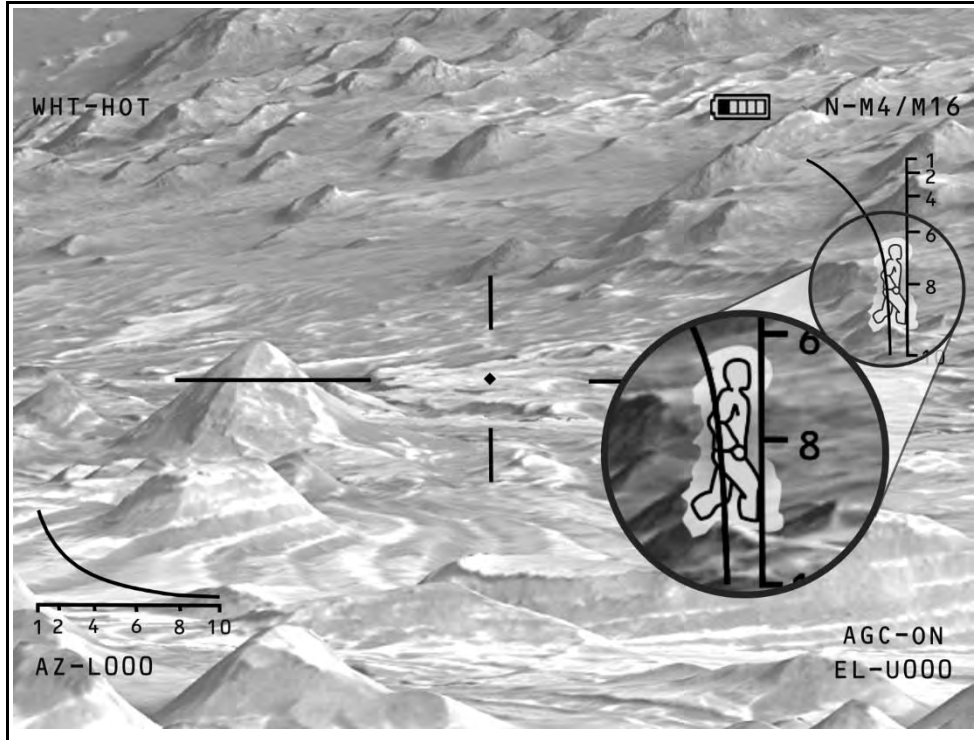

**Figure C-4. Reticle relationship using a stadiametric reticle example**

C-10. Anything that limits the visibility (such as weather, smoke, or darkness) will also limit the effectiveness of this method. To become proficient in using the appearance of objects method with accuracy, shooters must be familiar with the characteristic details of objects as they appear at various ranges.

**Appendix C**

---

**MOVING TARGETS**

C-11. Moving targets are those threats that appear to have a consistent pace and direction. Targets on any battlefield will not remain stationary for long periods of time, particularly once a firefight begins. Soldiers must have the ability to deliver lethal fires at a variety of moving target types and be comfortable and confident in the engagement techniques. There are two methods for defeating moving targets; tracking and trapping.

**Tracking Method**

C-12. The tracking method is used for a moving target that is progressing at a steady pace over a well-determined route. If a Soldier uses the tracking method, he tracks the target with the rifle's sight while maintaining sight alignment and a point of aim on or ahead of (leading) the target until the shot is fired.

C-13. When establishing a lead on a moving target, the rifle sights will not be centered on the target and instead will be held on a lead in front of the target. The basic lead formula for moving targets that are generally perpendicular to the shooter (moving across the sector of observation), is—

$$\frac{1}{100}R(7) = L$$

*or*

$$\frac{1}{100} \text{Range to Target} \times 7 = \text{Lead in Inches}$$

C-14. This formula is used to determine the baseline lead in the direction of travel of the target when its pace is approximately 3 mph or 4.5 feet per second (fps). Figure°C-5, on page C-7, shows the application of this formula at a notional moving target:

**Complex Engagements**

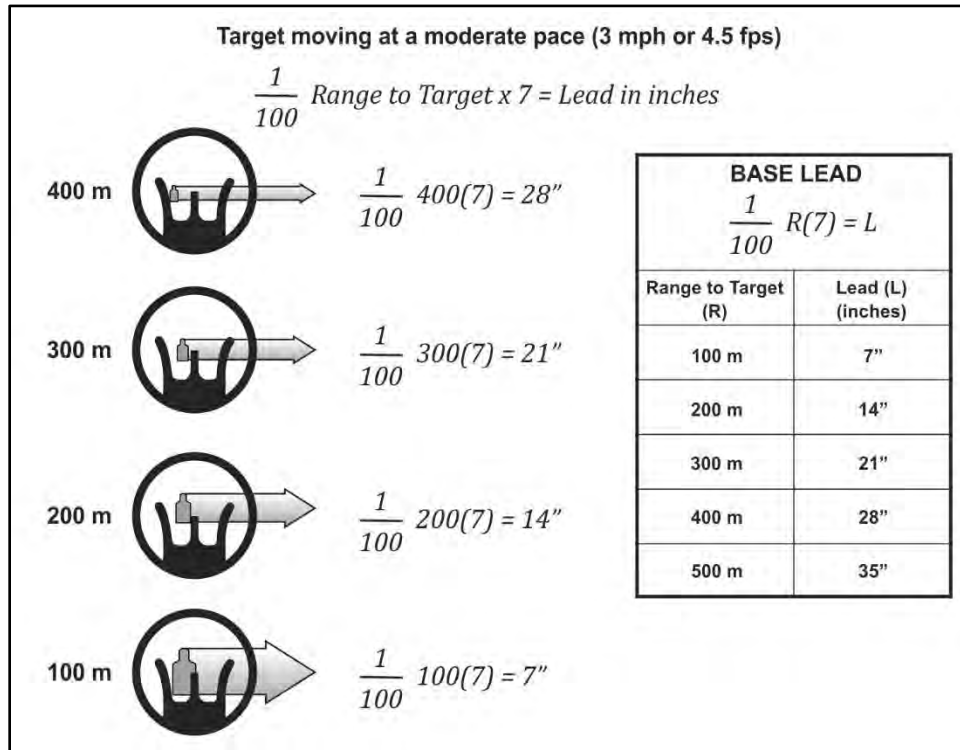

**Figure C-5. Deliberate lead formula example**

C-15. To execute the tracking method, a Soldier performs the following steps:

- Swing the muzzle of the rifle through the target (from the rear of the target to the front) to the desired lead (point of aim). The point of aim may be on the target or some point in front of the target depending upon the target's range, speed, and angle of movement.
- Track and maintain focus on the rifle's sight while acquiring the desired sight picture. It may be necessary to shift the focus between the rifle's sight and the target while acquiring the sight picture, but the focus must be on the rifle's sight when the shot is fired. Engage the target once the sight picture is acquired. While maintaining the proper lead,—
  - Follow-through so the lead is maintained as the bullet exits the muzzle.
  - Continue to track in case a second shot needs to be fired on the target.

**Trapping Method**

C-16. The trapping method (see figure C-6) is used when it is difficult to track the target with the aiming device, as in the prone or sitting position. The lead required to effectively engage the target determines the engagement point and the appropriate hold-off.

**Appendix C**

C-17. With the sights settled, the target moves into the predetermined engagement point and creates the desired sight picture. The trigger is pulled simultaneously with the establishment of sight picture. To execute the trapping method, a Soldier performs the following steps:

- Select an aiming point ahead of the target – where to set the trap.
- Obtain sight alignment on the aiming point.
- Hold sight alignment until the target moves into vision and the desired sight picture is established.
- Engage the target once sight picture is acquired.
- Follow-through so the rifle sights are not disturbed as the bullet exits the muzzle.

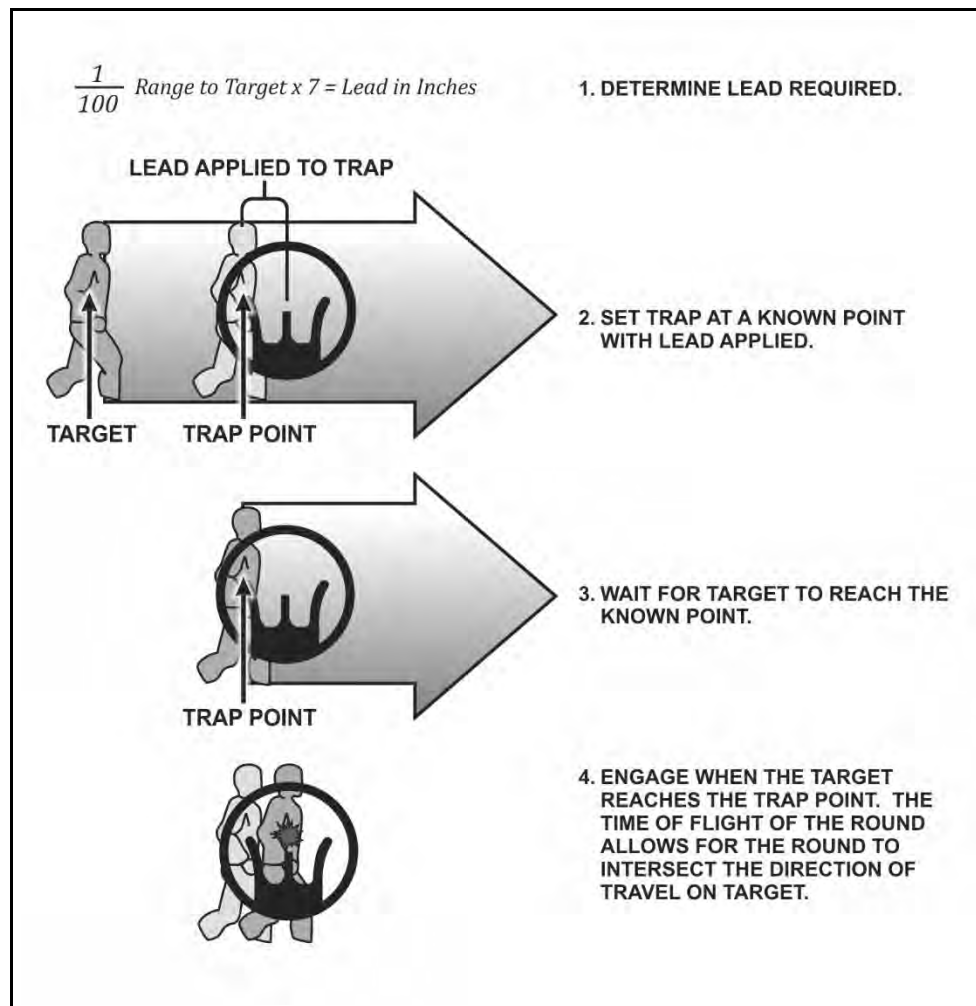

**Figure C-6. Deliberate trapping method example**

**Complex Engagements**

**OBLIQUE TARGETS**

C-18. Threats that are moving diagonally toward or away from the shooter are oblique targets. They offer a unique problem set to shooters where the target may be moving at a steady pace and direction; however, their oblique posture makes them appear to move slower.

C-19. Soldiers should adjust their hold-off based on the angle of the target's movement from the gun-target line. The following guide (see figure C-7) will help Soldiers determine the appropriate percentage of hold-off to apply to engage the oblique threats as they move.

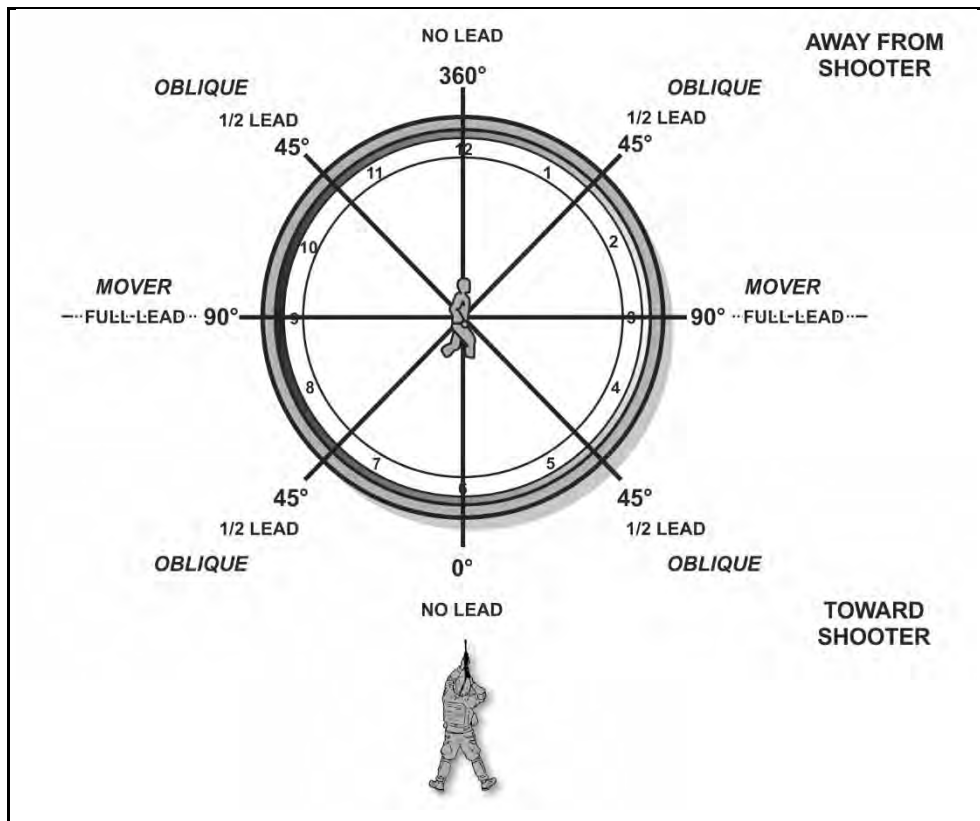

**Figure C-7. Oblique target example**



**Appendix C**

---

**ENVIRONMENTAL CONDITIONS**

C-20. The environment can complicate the shooter's actions during the shot process with excessive wind or requiring angled firing limited visibility conditions. Soldiers must understand the methods to offset or compensate for these firing occasions, and be prepared to apply these skills to the shot process. This includes when multiple complex conditions compound the ballistic solution during the firing occasion.

**WIND**

C-21. Wind deflection is the most influential element in exterior ballistics. Wind does not push the projectile causing the actual deflection. The bullet's tip is influenced in the direction of the wind slightly, resulting in a gradual drift of the bullet in the direction of the wind. The effects of wind can be compensated for by the shooter provided they understand how wind effects the projectile and the terminal point of impact. The elements of wind effects are—

- The **time** the projectile is exposed to the wind (range).
- The **direction** from which the wind is blowing.
- The **velocity** of the wind on the projectile during flight.

**Wind Direction and Value**

C-22. Winds from the left cause an effect on the projectile to drift to the right, and winds from the right cause an effect on the projectile to drift to the left. The amount of the effect depends on the time of (projectile's exposure) the wind speed and direction. To compensate for the wind, the firer must first determine the wind's direction and value. (See figure C-8 on page C-11.)

C-23. The clock system can be used to determine the direction and value of the wind. Picture a clock with the firer oriented downrange towards 12 o'clock.

C-24. Once the direction is determined, the value of the wind is next. The value of the wind is how much effect the wind will have on the projectile. Winds from certain directions have less effect on projectiles. The chart below shows that winds from 2 to 4 o'clock and 8 to 10 o'clock are considered full-value winds and will have the most effect on the projectile. Winds from 1, 5, 7, and 11 o'clock are considered half-value winds and will have roughly half the effect of a full-value wind. Winds from 6 and 12 o'clock are considered no-value winds and little or no effect on the projectile.

Complex Engagements

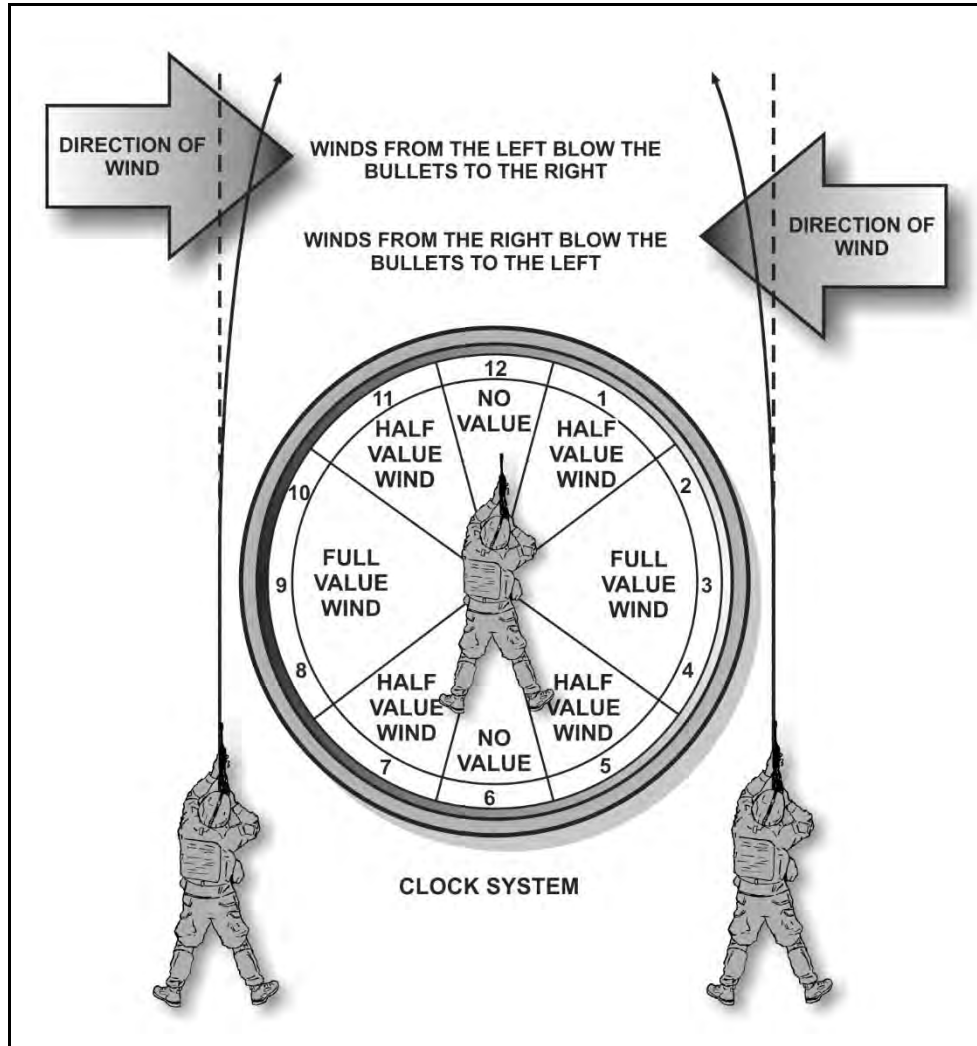

Figure C-8. Wind value

C-25. The wind will push the projectile in the direction the wind is blowing (see figure C-9). The amount of effects on the projectile will depend on the time of exposure, direction of the wind, and speed of the wind. To compensate for wind the Soldier uses a hold in the direction of the wind.

Appendix C

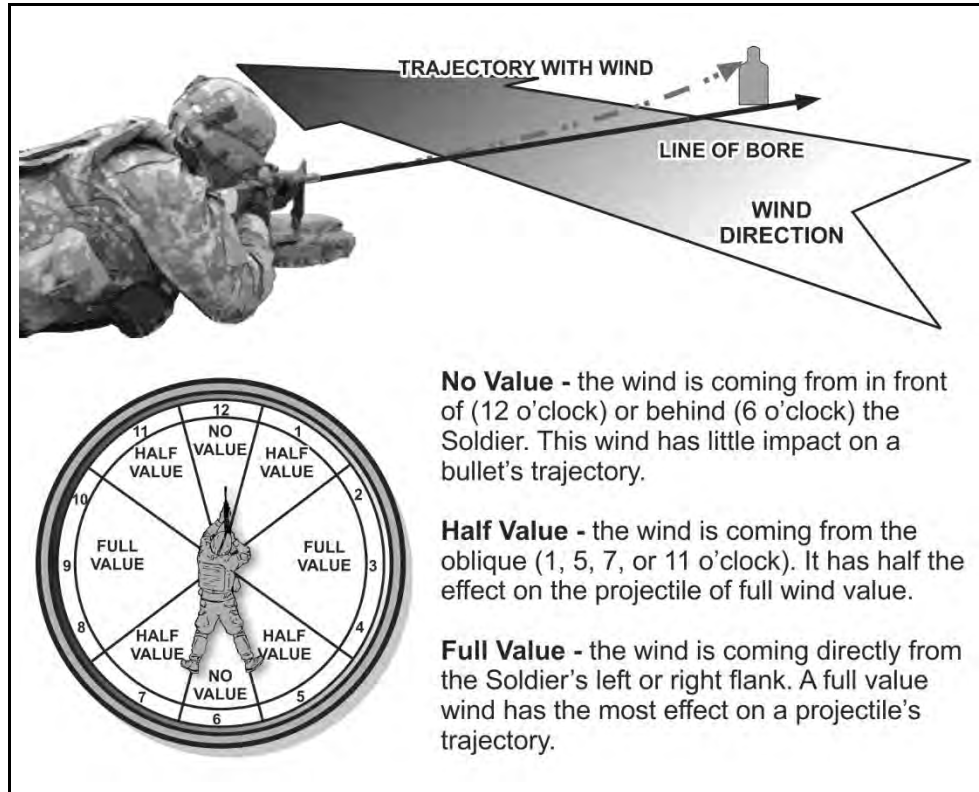

Figure C-9. Wind effects

---

**Complex Engagements**

**Wind Speed**

C-26. Wind speeds can vary from the firing line to the target. Wind speed can be determined by taking an average of the winds blowing on the range. The firer's focus should be on the winds between the firer and the target. The front 1/3 of the trajectory plays the most significant role in determining the bullet's wind drift deflection, but with increasing range, the firer must consider the wind speed at midpoint and the target area to make the best overall assessment.

C-27. The Soldier can observe the movement of items in the environment downrange to determine the speed. Each environment will have different vegetation that reacts differently.

C-28. Downrange wind indicators include the following:

- 0 to 3 mph = Hardly felt, but smoke drifts.
- 3 to 5 mph = Felt lightly on the face.
- 5 to 8 mph = Keeps leaves in constant movement.
- 8 to 12 mph = Raises dust and loose paper.
- 12 to 15 mph = Causes small trees to sway.

C-29. The wind blowing at the Soldiers location may not be the same as the wind blowing on the way to the target.

**Wind Estimation**

C-30. Soldiers must be comfortable and confident in their ability to judge the effects of the wind to consistently make accurate and precise shots. Soldiers will use wind indicators between the Soldier and the target that provide windage information to develop the proper compensation or hold-off.

C-31. To estimate the effects of the wind on the shot, Soldiers need to determine three windage factors:

- Velocity (speed).
- Direction.
- Value.

**Determining Wind Drift**

C-32. Once wind velocity, direction, and value have been determined, Soldiers determine how to compensate for the effects of wind. For the Soldier, there are three methods of determining the appropriate hold-off to adjust for excessive wind; using the wind formula, wind estimation, or referencing a generalized ballistic windage chart.

C-33. Once the range to target and wind speed are known, the formula below is used to determine drift. The output from the formula is in MOA. The final answer is rounded off to make the calculation quicker to perform. This formula (see figure C-10) will allow the Soldier to adjust for the distance that the wind displaces his projectile.

**Appendix C**

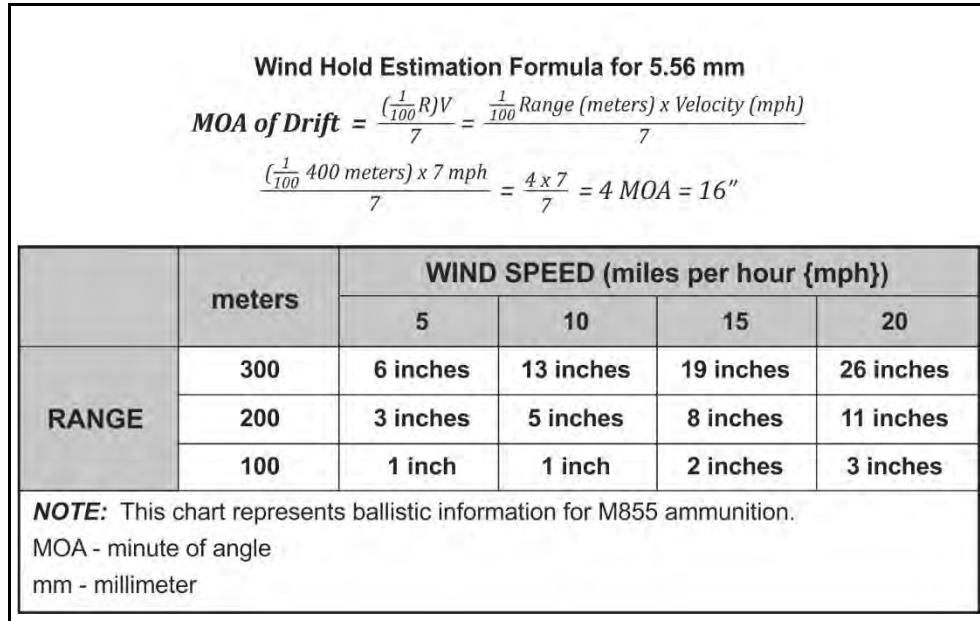

**Figure C-10. Wind formula and ballistics chart example**

C-34. The ballistics chart shows the wind drift in inches at ranges from 100 meters – 300 meters and wind speeds up to 20 mph. The data from the 100-m (meter) line shows that even in a 20-mph wind there is very little deflection of the round. At 300 meters, it can be seen that the same 20-mph wind will blow the bullet 26 inches. This illustrates the fact that the bullet is effected more by the wind the further it starts out from the target.

**Windage Hold**

C-35. Using a hold involves changing the point of aim to compensate for the wind drift. For example, if wind causes the bullet to drift 12 inches to the left, the aiming point must be moved 12 inches to the right. (See figure C-11 on page C-15.)

Complex Engagements

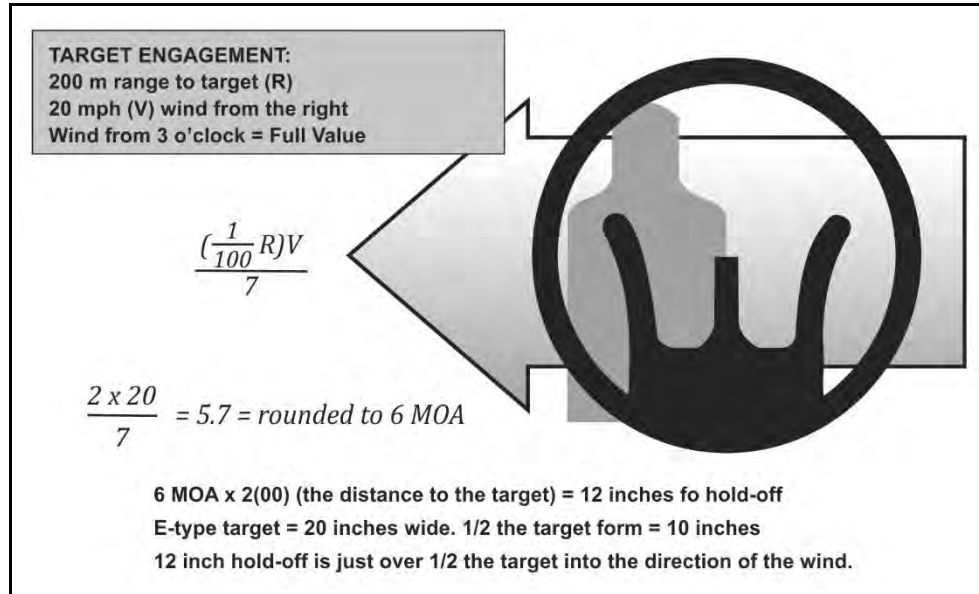

**Figure C-11. Hold-off example**

*Note.* The aiming point is center mass of the visual target, allowing for the greatest possibility of impacting the target. The hold off is based on the distance *from* center mass. Soldiers apply the hold-off creating the new point of aim.

C-36. Firers must adjust their points of aim into the wind to compensate for its effects. If they miss a distant target and wind is blowing from the right, they should aim to the right for the next shot. A guide for the initial adjustment is to split the front sight post on the edge of the target facing the wind.

C-37. Newly assigned Soldiers should aim at the target's center of visible mass for the first shot, and then adjust for wind when they are confident that wind caused the miss. Experienced firers should apply the appropriate hold-off for the first shot, but should follow the basic rule—when in doubt, aim at the center of visible mass.

**Appendix C**

---

**ANGLED FIRE**

C-38. Firing uphill or downhill at angles greater than 30 degrees, the firer must account for the change in the strike of the round from a horizontal trajectory. Rounds fired at excessive angles at extended ranges beyond the weapon’s zero distance strike high on the target. To compensate for this, firers can rapidly determine a correct firing solution using the Quick High Angle Formula.

C-39. The first step is to determine the appropriate hold for the range to target beyond zero distance. Table C-1 provides the approximate holds for M855A1, 5.56mm, Ball, Enhanced Performance Round (EPR) at ranges beyond the Army standard 300 meter zero—

**Table C-1. Standard holds beyond zero distance example**

<b>Range (meters)</b>	<b>Drop from Point of Aim (inches)</b>	<b>MOA Hold</b>	<b>Mil Hold</b>
400	-11.9	2.6	0.7
500	-31.4	5.5	1.6
600	-59.7	8.7	2.5

C-40. Next, the firer estimates the angle of fire to either 30, 45, or 60 degrees. The firer then applies that information to the Quick High Angle Formula to determine the approximate high angle hold. This formula is built to create a rapid hold adjustment that will get the shot on target.

C-41. Figure C-12 shows the quick high angle formula with an example in both MOA and mils. The example is based on a target at 500 meters, and provides effective solutions for the three angle categories; 30, 45, and 60 degrees.

**Complex Engagements**

<b>QUICK HIGH ANGLE FORMULA</b>				
	<b>DOWN ANGLE</b>	<b>MOA ADJUSTMENT/ 100 METERS</b>	<b>Mil ADJUSTMENT/ 100 METERS</b>	
	30°	-1/2 MOA	0.15 mils	
	45°	-1 MOA	0.3 mils	
	60°	-2 MOA per 100 meters, then add 1 MOA	0.6 mils per 100 meters, then add 0.3 mils	
<b>MINUTE OF ANGLE (MOA) EXAMPLE at 500 meters</b>				
<b>DEGREES</b>	<b>RANGE HOLD</b>	<b>ANGLE OFFSET (-)</b>	<b>60 DEGREE OFFSET (+)</b>	<b>HIGH ANGLE HOLD</b>
30°	5.5 MOA	- 2.5 MOA	+ 1 MOA	= 3 MOA
45°	5.5 MOA	- 5 MOA	+ 1 MOA	= 1/2 MOA
60°	5.5 MOA	- 10 MOA	+ 1 MOA	= -3 1/2 MOA
<b>MILS EXAMPLE at 500 meters</b>				
<b>DEGREES</b>	<b>RANGE HOLD</b>	<b>ANGLE OFFSET (-)</b>	<b>60 DEGREE OFFSET (+)</b>	<b>HIGH ANGLE HOLD</b>
30°	1.6 mils	- 0.75 mils	+ 0.1 mils	= +0.85 mils
45°	1.6 mils	- 1.5 mils	+ 0.1 mils	= +0.1 mils
60°	1.6 mils	- 3 mils	+ 0.3 mils	= -1.1 mils
<b>60° Rule of Thumb is Range Hold -2 MOA / 0.6 mil + High Angle Hold</b>				

**Figure C-12. Quick high angle formula example**



**Appendix C**

**COMPOUND CONDITIONS**

C-42. When combining difficult target firing occasion information, Soldiers can apply the rules specific to the situation together to determine the appropriate amount of hold-off to apply.

C-43. The example below shows the application of different moving target directions with varying speed directions. This is a general example to provide the concept of applying multiple hold-off information to determine complex ballistic solutions for an engagement. (See figure C-13.)

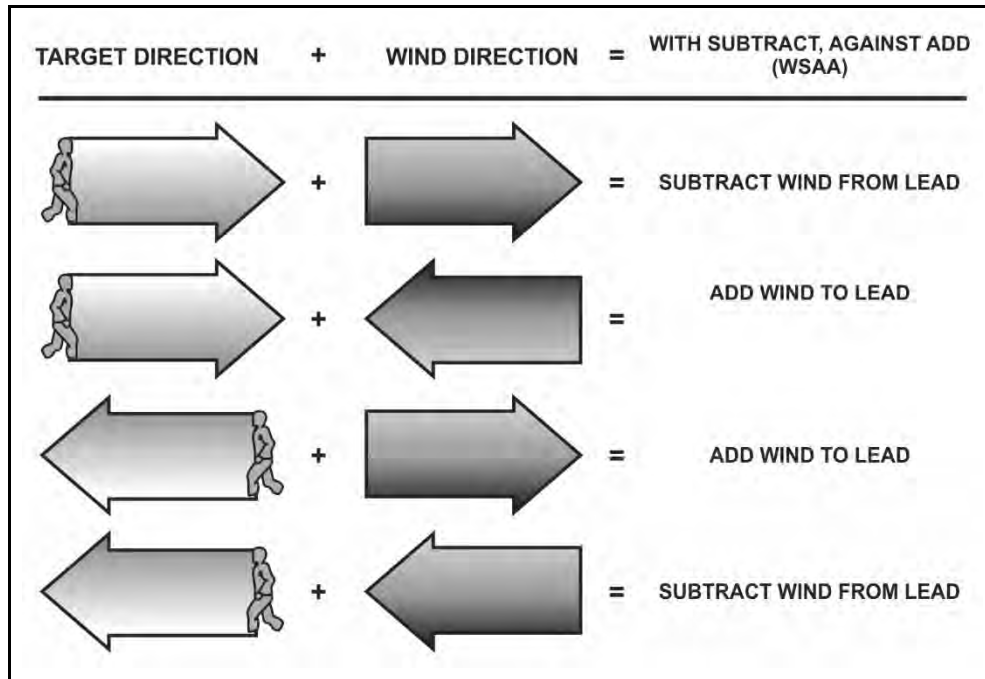

**Figure C-13. Compound wind and lead determination example**

## Appendix D

### Drills

This appendix describes the various drills for the rifle and carbine, and their purpose. The drill structure is standardized for all individual and crew served weapons in order to reinforce the most common actions all Soldiers need to routinely execute with their assigned equipment during training and combat.

These drills are used during Table III of the integrated weapons training strategy, as well as during routine maintenance, concurrent training, and during deployments. The drills found within this appendix are used to build and maintain skills needed to achieve proficiency and mastery of the weapon, and are to be ingrained into daily use with the weapon.

D-1. Each drill is designed to develop confidence in the equipment and Soldier actions during training and combat operations. As they are reinforced through repetition, they become second nature to the Soldier, providing smooth, consistent employment during normal and unusual conditions.

D-2. The drills provided are designed to build the Soldier's proficiency with the following principles:

- **Mindset** – the Soldier's ability to perform tasks quickly and effectively under stress.
- **Efficiency** – ensure the drills require the least amount of movement or steps to complete correctly. Make every step count.
- **Individual tactics** – ensure the drills are directly linked to employment in combat.
- **Flexibility** – provide drills that are not rigid in execution. Units may alter the procedural steps depending on their equipment, configuration, or tactical need.

### MINDSET

D-3. Continuous combat is inherently stressful. It exhausts Soldiers and causes physiological changes that reduce their ability to perform tasks as quickly or effectively as necessary. The Soldier's ability to function under stress is the key to winning battles, since, without the Soldier, weapons and tactics are useless. Individual and unit military effectiveness depend on the Soldier's ability to think clearly, accurately, quickly, all with initiative, motivation, physical strength, and endurance.

## Appendix D

---

D-4. The impact of physiological changes caused by the stress of combat escalates or de-escalates based on the degree of stimulation, causing Soldiers to attain different levels of awareness as events occur in the continually transitioning operational area around them. Maintaining a tactical mindset involves understanding one's level of awareness and transitioning between the levels of awareness as the situation requires escalation or de-escalation.

---

*Note.* Stress can be countered using the principles associated with Soldier resilience and performance enhancement. The Comprehensive Soldier and Family Fitness (CSF2) is designed to increase a Soldier's ability and willingness to perform an assigned task or mission and enhance his performance by assessing and training mental resilience, physical resilience, and performance enhancement techniques and skills. This initiative introduces many resources used to train Soldiers on skills to counter stress. For more information about CSF2, see <http://csf2.army.mil/>.

---

## EFFICIENCY

D-5. Efficiency is defined as the minimization of time or resources to produce a desired outcome. Efficient movements are naturally faster than movements that contain excessive or wasteful actions.

D-6. By reducing the amount of effort, mental, and/or physical, the movement becomes repeatable and the effect becomes predictable. This allows the Soldier to focus on the tactics while still maintaining the ability to produce accurate and precise fires.

## INDIVIDUAL TACTICS

D-7. Individual tactics are actions independent of unit standard operating procedures (SOPs) or situations that maximize the Soldier's chance of survival and victory in a small arms, direct fire battle.

D-8. Examples of individual tactics include use of cover and standoff, or the manipulation of time and space between a Soldier and his enemy.

## FLEXIBILITY

D-9. The techniques presented in this publication are not meant to be prescriptive, as multiple techniques can be used to achieve the same goal. In fact, there is no singular "one size fits all" solution to rifle fire; different types of enemies and scenarios require the use of different techniques.

D-10. However, the techniques presented are efficient and proven techniques for conducting various rifle-related tasks. Should other techniques be selected, they should meet the following criteria:

**Drills**

**RELIABLE UNDER CONDITIONS OF STRESS**

D-11. Techniques should be designed for reliability when it counts; during combat. The technique should produce the intended results without fail, under any conditions and while wearing mission-essential equipment.

D-12. It should also be tested under as high stress conditions as allowed in training.

**REPEATABLE UNDER CONDITIONS OF STRESS**

D-13. As combat is a stressor, a Soldier's body responds much as it does to any other stressful stimulus; physiological changes begin to occur, igniting a variable scale of controllable and uncontrollable responses based on the degree of stimulation.

D-14. The technique should support or exploit the body's natural reaction to life-threatening stress.

**EFFICIENCY IN MOTION**

D-15. The technique should be designed to create the greatest degree of efficiency of motion. It should contain only necessary movement. Excessive or unnecessary movement in a fighting technique costs time to execute. In a violent encounter, time can mean the difference between life and death.

D-16. Consider the speed at which violent encounters occur; An unarmed person can cover a distance of 20 feet in approximately 1 second. Efficiency decreases the time necessary to complete a task, which enhances the Soldier's safety.

**DEVELOP NATURAL RESPONSES THROUGH REPETITION**

D-17. When practiced correctly and in sufficient volume, the technique should build reflexive reactions that a Soldier applies in response to a set of conditions. Only with correct practice will a Soldier create the muscle memory necessary to serve him under conditions of dire stress. The goal is to create automaticity, the ability to perform an action without thinking through the steps associated with the action.

**LEVERAGE OVERMATCH CAPABILITIES**

D-18. Engagements can occur from 0 to 600 meters and any variance in between. Fast and efficient presentation of the rifle allows more time to stabilize the weapon, refine the aim, and control the shot required to deliver precise fires. This rapidly moves the unit toward the goal of fire superiority and gains/maintains the initiative. Speed should be developed throughout the training cycle and maintained during operations.

D-19. As distance between the Soldier and a threat decreases, so does the time to engage with well-place lethal fires. As distance increase, the Soldier gains time to refine his aim and conduct manipulations.

## Appendix D

---

### DRILLS

D-20. To build the skills necessary to master the functional elements of the shot process, certain tasks are integrated into drills. These drills are designed specifically to capture the routine, critical tasks or actions Soldiers must perform fluently and as a second nature to achieve a high level of proficiency.

D-21. Drills focus on the Soldier's ability to apply specific weapons manipulation techniques to engage a threat correctly, overcome malfunctions of the weapon or system, and execute common tasks smoothly and confidently.

#### DRILL A – WEAPON CHECK

D-22. The weapon check is a visual inspection of the weapon by the Soldier. A weapon check includes at a minimum verifying:

- Weapon is clear.
- Weapon serial number.
- Aiming device(s) serial number.
- Attachment points of all aiming devices, equipment, and accessories.
- Functions check.
- Proper location of all attachments on the adaptive rail system.
- Zero information.
- Serviceability of all magazines.

D-23. The weapon check is initiated when first receiving the weapon from the arms room or storage facility. This includes when recovering the weapon when they are stacked or secured at a grounded location.

D-24. Units may add tasks to Drill A as necessary. Units may direct Soldiers to execute Drill A at any time to support the unit's mission.

#### DRILL B – SLING/UNSLING OR DRAW/HOLSTER

D-25. This drill exercises the Soldier's ability to change the location of the weapon on demand. It reinforces their ability to maintain situational and muzzle awareness during rapid changes of the weapon's sling posture. It also provides a fitment check between the weapon, the Soldier's load bearing equipment, and the Soldier's ability to move between positions while maintaining effective use of the weapon.

D-26. When conducting this drill, Soldiers should:

- Verify the proper adjustment to the sling.
- Rotate the torso left and right to ensure the sling does not hang up on any equipment.
- Ensure the weapon does not interfere with tactical movement.

#### DRILL C – EQUIPMENT CHECK

D-27. This drill is a Pre-Combat Check (PCC) that ensures the Soldier's aiming devices, equipment, and accessories are prepared –

---

**Drills**

- Batteries.
- Secured correctly.
- Equipment does not interfere with tactical movement.
- Basic load of magazines are stowed properly.

**DRILL D – LOAD**

D-28. This is predominantly an administrative loading function. This allows the Soldier to develop reliable loading techniques.

**DRILL E – CARRY (FIVE/THREE)**

D-29. This is a series of five specific methods of carrying the weapon by a Soldier. These five methods are closely linked with range operations in the training environment, but are specifically tailored to combat operations. This drill demonstrates the Soldier's proficiency moving between:

- Hang.
- Safe hang.
- Collapsed low ready.
- Low ready.
- High ready (or ready up).

D-30. A leader will announce the appropriate carry term to initiate the drill. Each carry method should be executed in a random order a minimum of three times.

**DRILL F – FIGHT DOWN**

D-31. The Fight Down drill builds the Soldier's understanding of how to move effectively and efficiently between firing postures. This drill starts at a standing position, and, on command, the Soldier executes the next lower position or the announced position by the leader. The Fight Down drill exercises the following positions in sequence:

- Standing.
- Kneeling.
- Sitting.
- Prone.

D-32. Each position should be executed a minimum of three times. Leaders will use Drill F in conjunction with Drill G.

**DRILL G – FIGHT UP**

D-33. The Fight Up drill builds the Soldier's timing and speed while moving from various positions during operations. This drill starts in the prone position, and, on command, the Soldier executes the next higher position or the announced position by the leader. The Fight Up drill exercises the following positions in sequence:

- Prone.
- Sitting.

## **Appendix D**

---

- Kneeling.
- Standing.

D-34. Each position should be executed a minimum of three times. Leaders will use Drill F, Fight Down, in conjunction with Drill G, Fight Up.

D-35. Leaders may increase the tempo of the drill, increasing the speed the Soldier needs to assume the next directed position. After the minimum three iterations are completed (Drill F, Drill G, Drill F, Drill G, etc.), the leader may switch between Drill F and G at any time, at varying tempo.

### **DRILL H – GO-TO-PRONE**

D-36. The Go-To-Prone drill develops the Soldier's agility when rapidly transitioning from a standing or crouched position to a prone firing position. Standard time should be below 2 seconds.

D-37. Leaders announce the starting position for the Soldier to assume. Once the Soldier has correctly executed the start position to standard, the leader will announce GO TO PRONE. This drill should be conducted a minimum of five times stationary and five times while walking.

D-38. Leaders should not provide preparatory commands to the drill, and should direct the Soldier to go to prone when it is unexpected or at irregular intervals. Leaders may choose to include a tactical rush with the execution of Drill H.

### **DRILL I – RELOAD**

D-39. The Tactical Reload drill is executed when the Soldier is wearing complete load bearing equipment. It provides exercises to assure fast reliable reloading through repetition at all firing positions or postures.

D-40. The Soldier should perform Drill I from each of the following positions a minimum of seven times each:

- Standing.
- Squatting.
- Kneeling.
- Prone.

D-41. Leaders may include other drills while directing Drill I to the Soldier to reinforce the training as necessary.

### **DRILL J – CLEAR MALFUNCTION**

D-42. This drill includes the three methods to clear the most common malfunctions on a rifle or carbine in a rapid manner, while maintaining muzzle and situational awareness. Soldiers should perform all three variations of clearing a malfunction based on the commands from their leader.

---

**Drills**

D-43. Each of the three variations of Drill J should be executed five times. Once complete, leaders should incorporate Drill J with other drills to ensure the Soldier can execute the tasks at all positions fluently.

**DRILL K – UNLOAD / SHOW CLEAR**

D-44. This is predominantly an administrative unloading function, and allows the Soldier to develop reliable clearing techniques. This drill should be executed in tandem with Drill D, Load. It should be executed a minimum of seven times in order to rotate through the Soldier's magazine pouch capacity, and reinforce the use of a "dump pouch" or pocket, to retain expended magazines during operations.

D-45. This drill can be executed without ammunition in the weapon. Leaders may opt to use dummy ammunition or spent cartridge cases as desired. In garrison environments, Leaders should use Drill K on demand, particularly prior to entering buildings or vehicles to reinforce the Soldier's skills and attention to detail.



This page intentionally left blank.

## Appendix E

# Zeroing

Zeroing a weapon is not a training exercise, nor is it combat skills event. Zeroing is a maintenance procedure that is accomplished to place the weapon in operation, based on the Soldier's skill, capabilities, tactical scenario, aiming device, and ammunition. Its purpose is to achieve the desired relationship between the line of sight and the trajectory of the round at a known distance. The zeroing process ensures the Soldier, weapon, aiming device, and ammunition are performing as expected at a specific range to target with the least amount of induced errors.

For Soldiers to achieve a high level of accuracy and precision, it is critical they zero their aiming device to their weapon correctly. The Soldier must first achieve a consistent grouping of a series of shots, then align the mean point of impact of that grouping to the appropriate point of aim. Soldiers use the process described in this appendix with their weapon and equipment's technical manuals to complete the zeroing task.

## BATTLESIGHT ZERO

E-1. The term battlesight zero means the combination of sight settings and trajectory that greatly reduces or eliminates the need for precise range estimation, further eliminating sight adjustment, holdover or hold-under for the most likely engagements. The battlesight zero is the default sight setting for a weapon, ammunition, and aiming device combination.

E-2. An appropriate battlesight zero allows the firer to accurately engage targets out to a set distance without an adjusted aiming point. For aiming devices that are not designed to be adjusted in combat, or do not have a bullet drop compensator, such as the M68, the selection of the appropriate battlesight zero distance is critical.

## ZEROING PROCESS

E-3. A specific process should be followed when zeroing. The process is designed to be time-efficient and will produce the most accurate zero possible.

E-4. The zero process includes mechanical zero, laser borelight, 25-m grouping and zeroing, and zero confirmation out to 300 meters.

---

## Appendix E

---

*Note.* Although wind and gravity have the greatest effect on the projectile's trajectory, air density and elevation must also be taken into consideration.

---

### LASER BORELIGHT

E-5. The borelight is an eye-safe laser that is used to boresight optics, iron sights, and aiming lasers. The borelight assists the first shot group hitting the 25-m zeroing target when zeroing the weapon. Using the borelight will save range time and require less rounds for the zeroing process. Borelighting is done with a borelight, which is centered in the bore of the weapon, and with an offset target placed 10 meters from the muzzle of the weapon.

### 25-M GROUPING AND ZEROING

E-6. After successfully boresighting the weapon, the next step is to perform grouping and zeroing exercises. Grouping and zeroing is done at 25 meters on a 25-m zero target or at known distance range.

#### 25-M GROUPING

E-7. The goal of the grouping exercise is for the shooter to fire tight shot groups and consistently place those groups in the same location. Tight, consistently placed shot groups show that the firer is applying proper aiming and smooth trigger control before starting the zeroing process. The firer should not start the zeroing process until they have demonstrated their ability to group well.

#### 25-M ZEROING

E-8. Once the firer has shown their ability to accurately group, they should begin adjusting the aiming device to move the groups to the center of the target. During the zeroing process, the firer should attempt to center their groups as much as possible. Depending on the aiming device used, there may be a zero offset that needs to be used at 25 meters. During the zeroing process it is important that the firer adjusts their groups as close to the offset mark as possible.

### ZERO CONFIRMATION OUT TO 300 METERS

E-9. The most important step in the zeroing process is zero confirmation out to 300 meters. Having a 25 m zero does not guarantee a center hit at 300 meters. The only way to rely on a 300-m hit, is to confirm a 300-m zero.

E-10. Confirmation can be done on any range where Soldiers can see the impacts of their rounds. Groups should be fired and aiming devices should be adjusted. At a minimum, the confirmation should be done at 300 meters. If rounds are available, groups can be fired at various ranges to show the firers where their impact will be.

E-11. When confirming zero at ranges past 100 meters, the effects of the wind needs to be considered and acted upon, if necessary. If a zero is confirmed at 300 meters on a windy day, and then the weapon is fired at a later date in different wind conditions or no wind at all, the impact will change. (See figure E-1 on page E-3.)

**Zeroing**

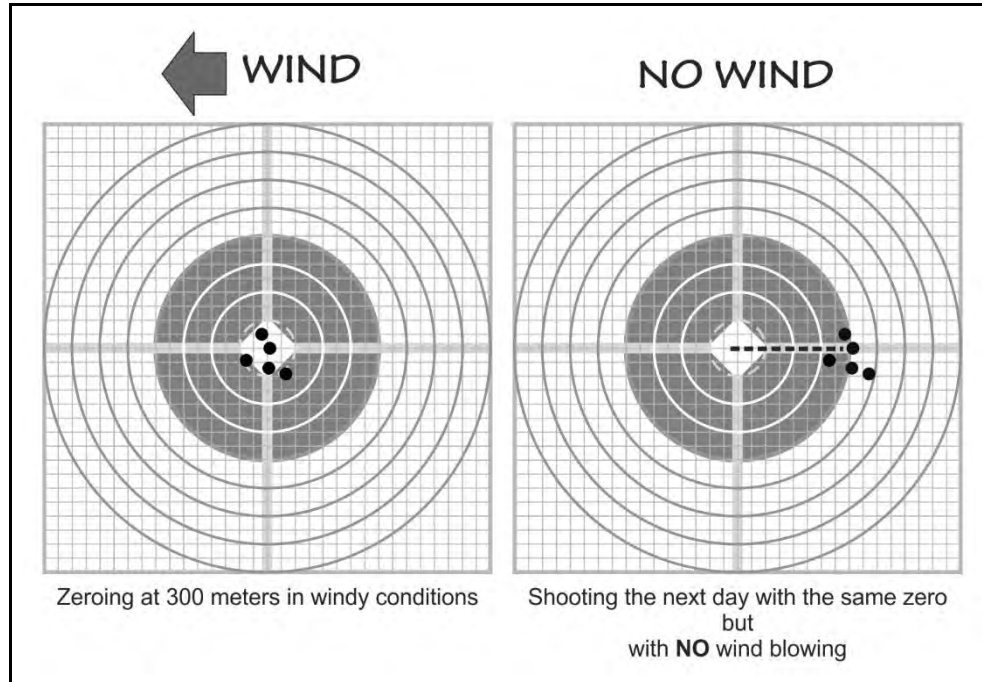

**Figure E-1. Wind effects on zero at 300 meters**

### **DOWNRANGE FEEDBACK**

E-12. Feedback must be included in all live-fire training. Soldiers must have precise knowledge of a bullet strike; feedback is not adequate when bullets from previous firings cannot be identified. To provide accurate feedback, trainers ensure that Soldiers triangulate and clearly mark previous shot groups on a zeroing target or receive a hard copy from the tower on an automated range.

E-13. After zeroing, downrange feedback should be conducted. If modified field fire or known distance ranges are not available, a series of scaled silhouette targets can be used for training on the 25-m range.

E-14. With the M4- and M16-series of weapons, this range is 25 to 300 meters. This means, that with a properly zeroed rifle, the firer can aim center mass of a target between 25 meters and 300 meters and effectively engage it. A properly trained rifleman should be able to engage targets out to 600 meters in the right circumstances.

---

**Appendix E**

---

*Note.* A common misconception is that wearing combat gear will cause the zero to change. Adding combat gear to the Soldier's body does not cause the sights or the reticle to move. The straight line between the center of the rear sight aperture and the tip of the front sight post either intersects with the trajectory at the desired point, or it does not. Soldiers should be aware of their own performance, to include a tendency to pull their shots in a certain direction, across various positions, and with or without combat gear. A shift in point of impact in one shooting position may not correspond to a shift in the point of impact from a different shooting position.

---

E-15. Figure E-2, on page E-5, shows the zeroing target for use for the M16A2/M16A4. Figure E-3, on page E-6, M4-/M16-series weapons.

Zeroing

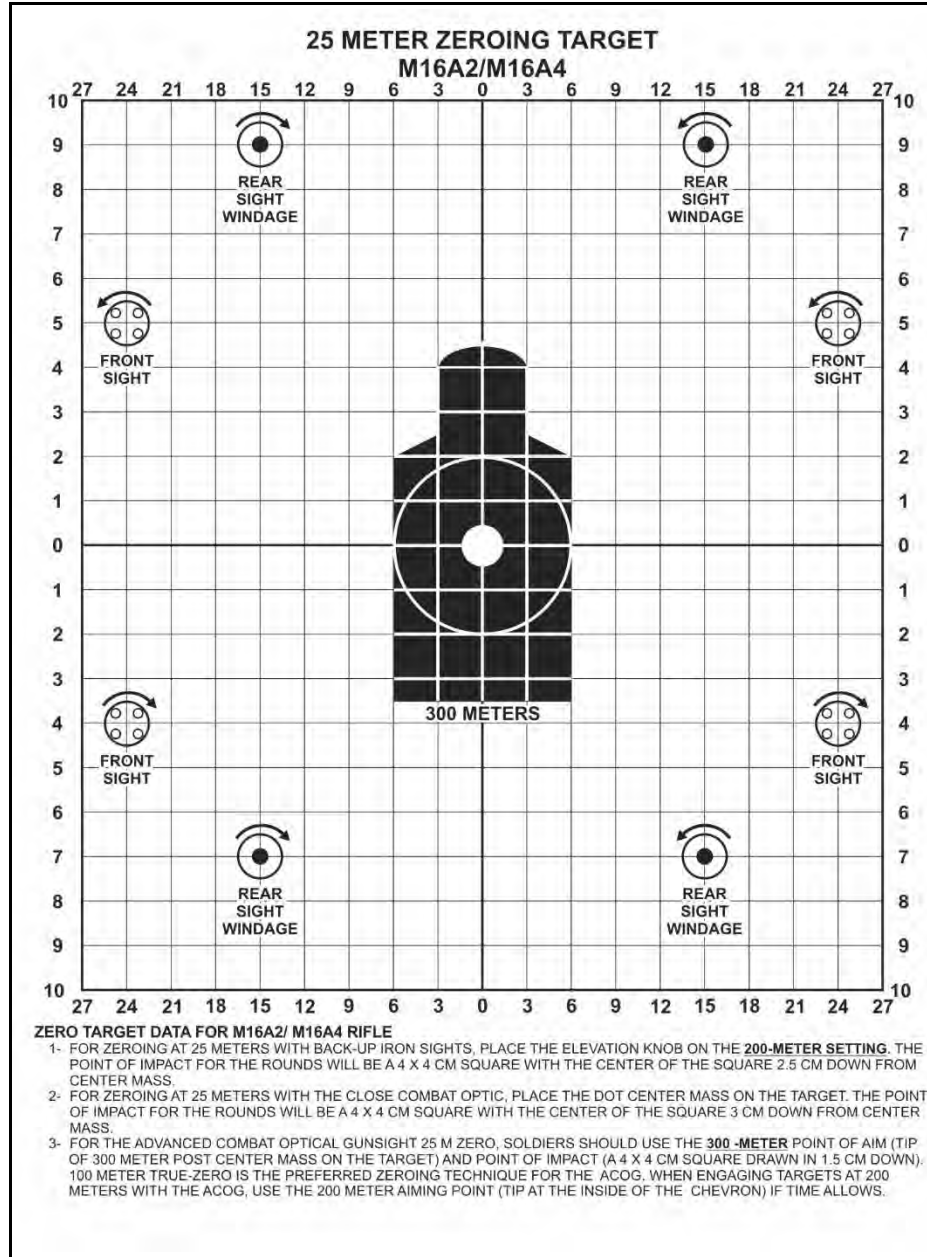
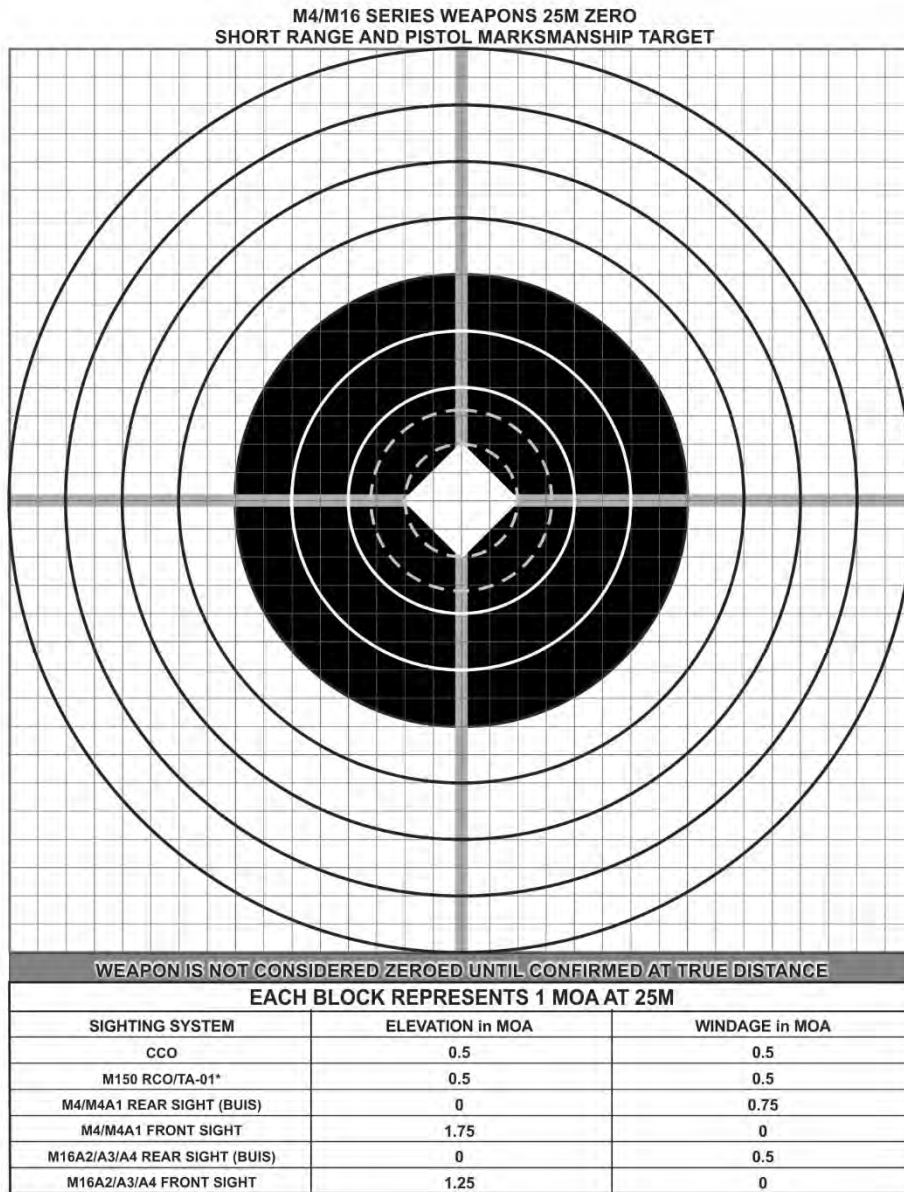

Figure E-2. M16A2 / M16A4 weapons 25m zero target

Appendix E



**Figure E-3. M4-/M16-series weapons 25m zero short range and pistol marksmanship target**

**Zeroing**

E-16. A good zero is necessary to be able to engage targets accurately. Whenever the Soldier deploys or does training in a new location, they should confirm the zero on their rifle if possible, as elevation, barometric pressure, and other factors will affect the trajectory of a round. There are multitudes of factors that can affect a zero, and the only sure way to know where the rounds are going, is to fire the rifle to confirm.

E-17. The zero on each assigned rifle WILL NOT transfer to another rifle. For example, if the windage zero on the Soldier's iron sights was three minutes (3MOA) left of center, putting that same setting on another rifle does not make it zeroed. This is due to the manufacturing difference between the weapons.

E-18. It is recommended that Soldiers setup their equipment and dry practice in position with gear on before coming to the range.

E-19. Standard in Training Commission (STRAC) Department of the Army Pamphlet (DA PAM) 350-38 allocates ammunition to conduct zeroing procedures using three-shot groups. The preferred method is to use a five-shot grouping, allowing the firer to more accurately analyze their shot group. Figure E-4 shows similar three-shot and five-shot groups with one shot on the right edge of the group. If all the shots were taken into account in the three-shot group, the firer would probably adjust their zero from the right edge of the four-cm circle. It is possible that the shot on the right was a poor shot and should not be counted in the group. The five-shot group on right is in the same place as the one on the left with the exception of the one shot out to the right. With four out of five shots in a tight group, the wide shot can be discounted and little or no change to the windage is necessary.

E-20. Part of the grouping and zeroing process is the marking and analysis of shot groups.

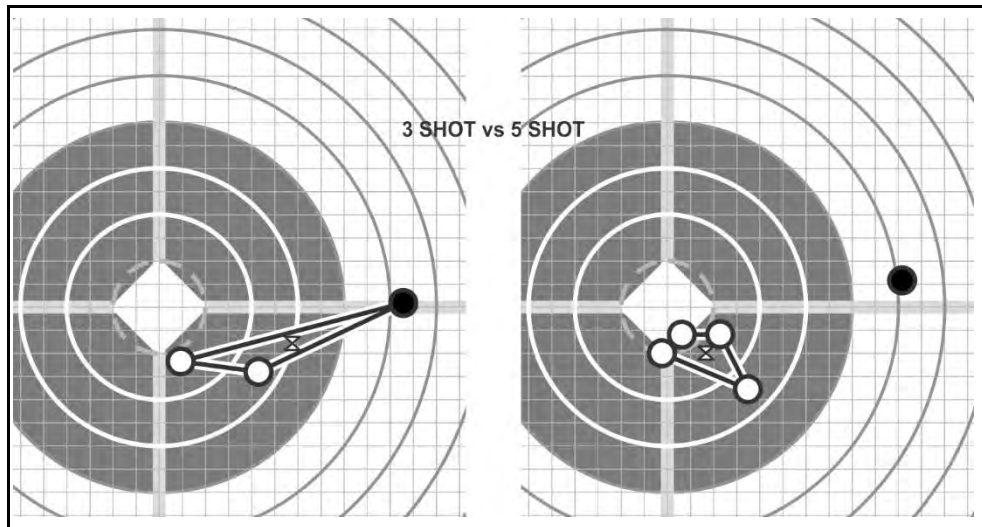

**Figure E-4. Grouping**



**Appendix E**

**MARKING THE SHOT GROUP**

E-21. If possible, shot groups should be marked using different colored markers so the firer can track their progress. Figure E-5 shows a technique for marking shot groups on a zero target. This technique allows the firer and coach to track their progress throughout the grouping and zeroing phase.

E-22. All sight adjustments are from the center of the group, called the *mean point of impact (MPI)*, and not from the location of a single shot. When using five-shot group, a single shot that is outside of the rest of the group should not be counted in the group for sight adjustment purposes.

*Note.* This figure depicts the color variations in shades of gray.

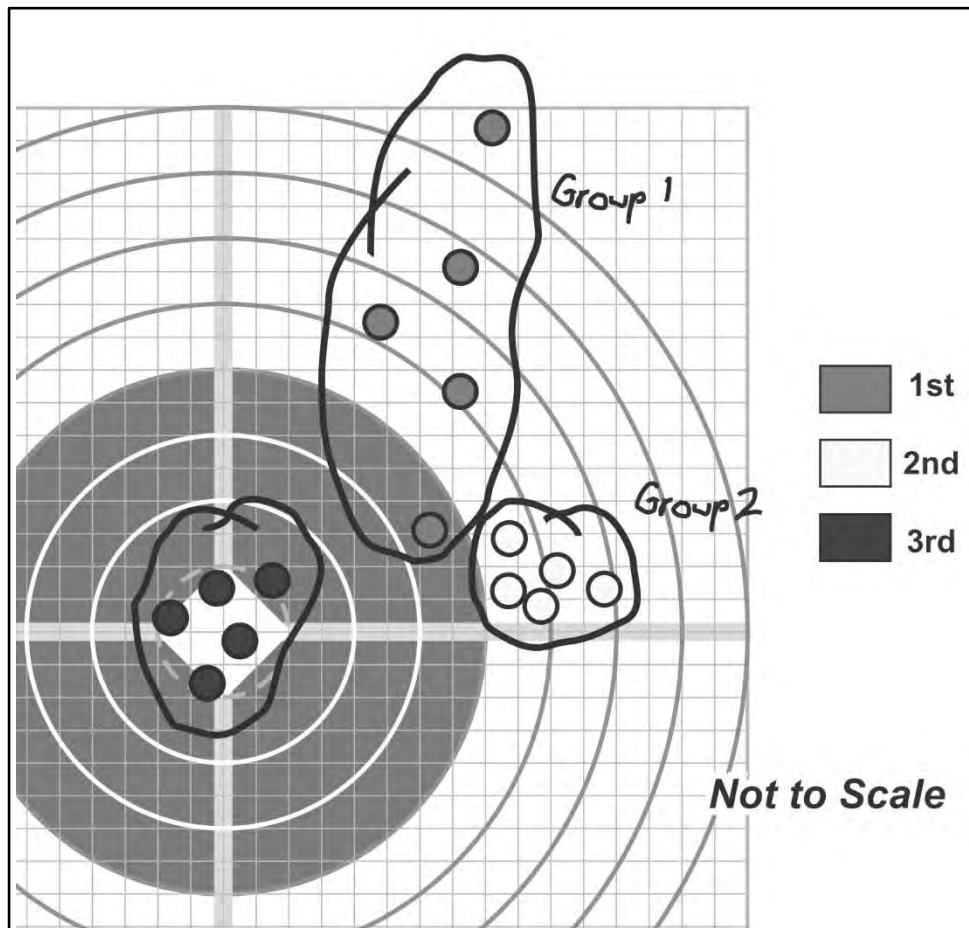

**Figure E-5. Marking shot groups**

---

**Zeroing**

E-23. The firer shoots and marks their first shot group with a colored marker. The color of the first group is noted by placing a line with that marker next to the 1 on the right side of the zero target. Groups are fired and marked until they are consistently in the same location.

E-24. Each sight adjustment is annotated in the same color as the group that was just fired.

## **COACHING**

E-25. Coaching is the process of having another Soldier observe the firer during the firing process to look for shooting errors that the firer themselves may not consciously know they are making.

### **TYPES OF COACHES**

E-26. Firing a rifle properly requires the consistent and proper application of the elements of employment. It is about doing the right thing, the same way, every shot. The small arms trainer is also the validation point for any questions during employment training. In most cases, once group training is completed, it will be the firer's responsibility to realize and correct his own firing errors but this process can be made easier through the use of a coach.

E-27. Two types of coaches exist, the experienced coach and the peer coach. Although each should execute coaching the same way, experienced coaches have a more thorough understanding of employment and should have more knowledge and practice in firing than the Soldiers they are coaching. Knowledge and skill does not necessarily come with rank therefore Soldiers serving as experienced coaches should be carefully selected for their demonstrated firing ability and their ability to convey information to firers of varying experience levels.

### **EXPERIENCED COACHES**

E-28. Experienced coaches are generally in shorter supply throughout the Army and are generally outnumbered by less skilled firers. This lack of experienced coaches usually leads to one experienced coach watching multiple firers dependent upon the table or period of employment being fired. It often helps the experienced coach to make notes of errors they observe in shooters and discuss them after firing that group. It is often difficult for the coach to remember the errors that they observe in each and every firer.

### **PEER COACHES**

E-29. Using a peer coach, although generally not as effective as using an experienced coach, is still a very useful technique. The advantage of using a peer coach is two-fold: a peer coach may use their limited knowledge of employment to observe the firer when an experienced coach is not available or is occupied with another firer and can either talk the firer through the shooting errors that they have observed or bring any observed shooting errors to the attention of the experienced coach. The other advantage of using a peer coach is that the peer coach themselves, through the act of coaching, may be able to observe mistakes made by the firer and learn from them before making the mistakes

## Appendix E

---

themselves. Many people grasp instruction more deeply when they are coaching others than when they are simply told to do something.

---

*Note.* Peer coaches can be limited by their level of training.

---

E-30. Except for aiming, the coach can observe most of the important aspects of the elements of employment. To determine the unobservable errors of shooting the coach and the firer must have an open dialog and there must be a relaxed environment for learning. The firer cannot be hesitant to ask questions of the coach and the coach must not become a stressor during firing. The coach must have the ability to safely move around the firer to properly observe. There is no one ideal coaching position. The following section will discuss the elements of shooting and how best to observe them as a coach.

### STABILIZE

E-31. For the coach to observe how stable the shooter is, they may have to move to different sides of the shooter. To observe the shooter's non-firing elbow (to ensure it makes contact with the ground), the coach will need to be on the shooter's non-firing side. To observe the cant of the weapon (the sights on the weapon should be pointing towards 12 o'clock position, not 11 or 1 o'clock positions), the coach will need to watch the relationship of the front sight to the barrel from behind the shooter. The coach should look for all the other aspects of good positions as outlined in chapter 6 of this publication. The coach should also observe the total amount of weapon movement on recoil. A good stable position will have minimal movement under recoil.

### AIMING

E-32. Determining the aspects of the firer's aiming (sight picture, sight alignment, point of focus) requires dialogue between the firer and the coach. Often, a shooter will not realize his aiming errors until he discovers them on his own. The only method a coach has to observe aiming errors is to use of an M16 sighting device (A2, left and right, DVC-T 7-84), but this device can only be used on rifles with carrying handle sights. Without the use of a sighting device, the coach must rely on drawings, discussions, or the use of an M15A1 aiming card (DVC-T 07-26) to determine where the firer is aiming on the target, his focus point during firing (which should be the front sight), and where his front sight was at the moment of firing in relation to the rear sight aperture and the point of aim on the target. The technique of having the firer call his shots should also be used. This technique involves calling the point on the target where the sights were located at the moment of firing and matching the point called with the impact locations on the target. Calling the shot helps the firer learn to focus on the front sight during the entire firing process.

E-33. When optics are being used, the shooter can tell the coach where he was holding. This is of particular importance with the RCO. Coaches must insure the 300m aim point is used when zeroing at 25-m.

---

**Zeroing**

**CONTROL**

E-34. The ideal position to observe trigger squeeze is from the non-firing side because the coach will have a better view of the speed of pull, finger position on the trigger, and release or pressure on the trigger after firing. The coach can look from behind the shooter to observe the barrel for lateral movement caused by slapping the trigger during firing.

**COACHING FACTORS**

E-35. All firing happens at the weapon. This means that the coach should be focused solely on the shooter during firing and not on what is happening down range.

E-36. There is no way for a coach to observe only the bullets impact on target and know what errors the firer made. The coach must watch the shooter during firing to determine errors and use the impacts to confirm their assumptions.

E-37. For a coach to properly observe all aspects of firing they must be able to observe the shooter, safely, from both sides and the back. There is no prescribed coaching position.

E-38. Coaching requires a relaxed atmosphere with open communication between the firer and the coach.

**SHOT GROUP ANALYSIS**

E-39. Shot group analysis involves the firer correlating the shots on paper with the mental image of how the shots looked when fired. An accurate analysis of the shot group cannot be made by merely looking at the holes in the paper. It is more important to observe the firer than to try and analyze the target. All firing takes place at the weapon, and the holes in the paper are only an indicator of where the barrel was pointed when the rifle was fired. When coaches are analyzing groups, they must question the firer about the group to make a determination of what caused the placement of the shots.

E-40. For example, if the firer has a tight group – minus one shot that is well outside of the group, the firer should have observed the outlying shot while firing. The firer would discount this shot when marking their group. (See figure E-6a and figure E-6b.) If a coach is analyzing the group, the firer would tell them that they performed poorly on the one shot that is out of the group.

Appendix E

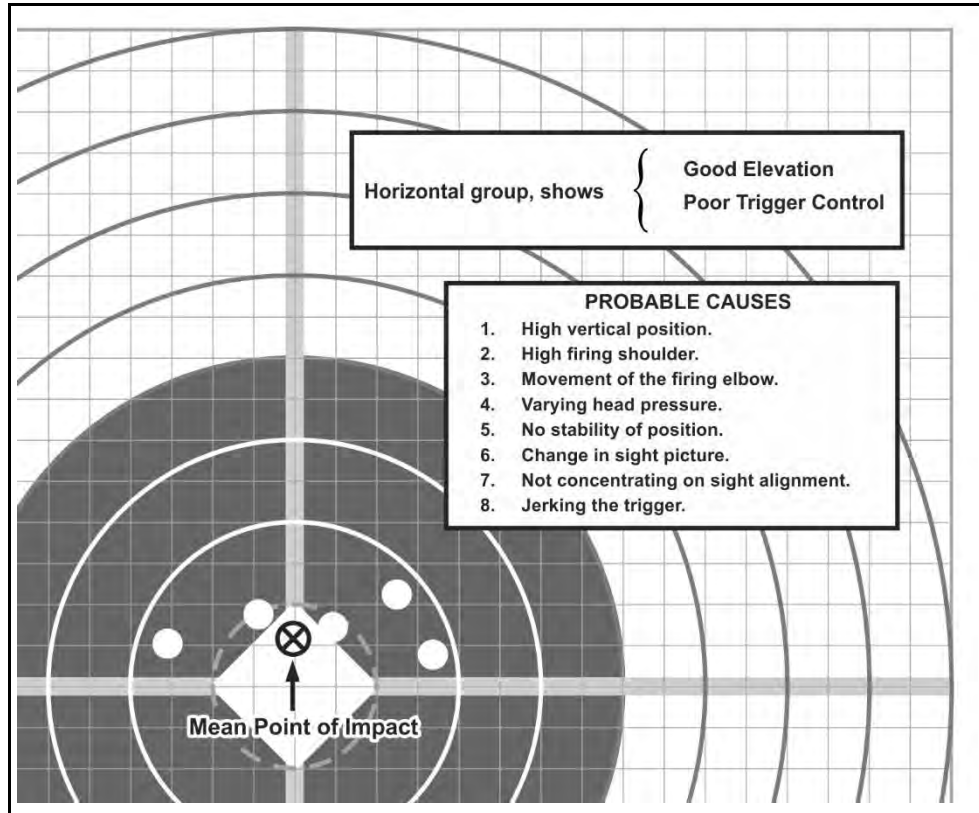
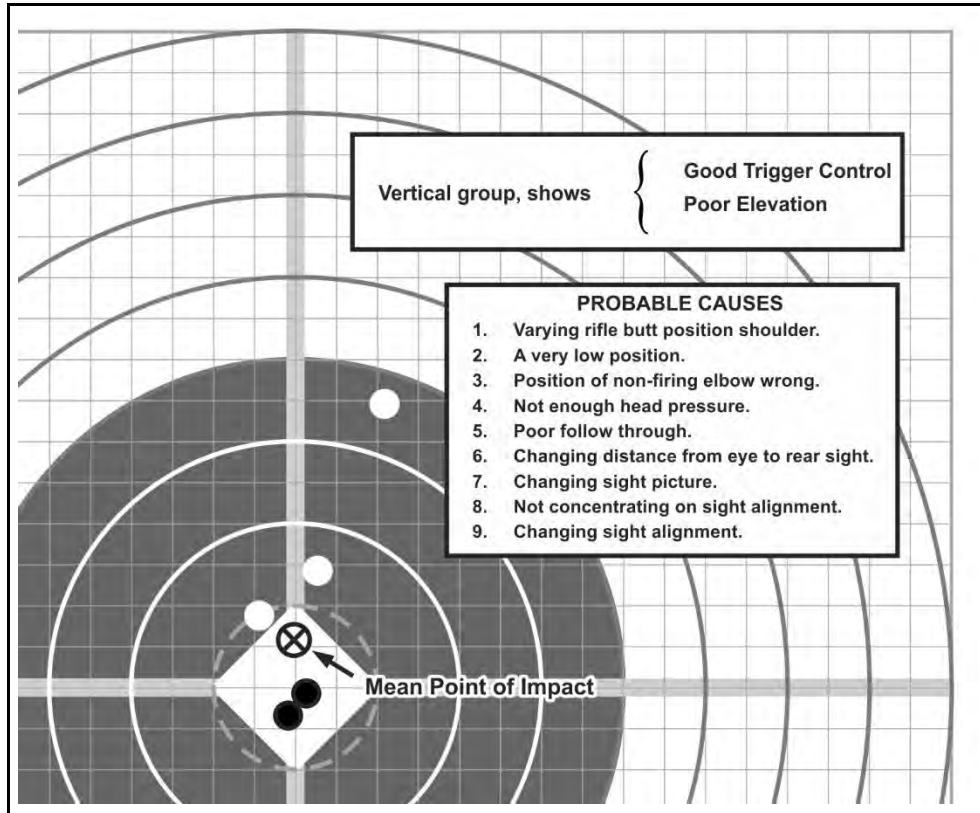

Figure E-6a. Horizontal diagnostic shots

**Zeroing**



**Figure E-6b. Vertical diagnostic shots**

E-41. Novice shooters may benefit from not marking their own shot group. When marking a shot group an inexperienced or stressed Soldier may unintentionally make mental corrections. These mental corrections along with the mechanical corrections to their weapon will cause further issues during follow on shot groups. The experienced Soldier is less likely to make adjustments to their sight placement along with the mechanical changes to the weapon, knowing the zero process is aligning the sights to the location of the impact of the rounds. Having a coach or the employment instructor simply inform the Soldier of mechanical changes needed to the aiming device is an effective way to accomplish this method.

E-42. Observing the shooter must be accomplished before analyzing the target can become effective. Bullets strung vertically do not necessarily mean a breathing issue, nor do bullets strung horizontally absolutely indicate a trigger squeeze problem. Coaches must learn to identify shooter errors during firing and use the bullet's impacts on target to confirm their observations. There are often several firing errors that can be the cause of certain misplacements of impacts. The coach has to realize that bullets only go where

## **Appendix E**

---

the barrel is pointed, so he has to determine what happened that caused the barrel to be pointed in those directions, and those causes can be many.

E-43. They key to proper coaching is becoming a shooting DETECTIVE. The coach needs to observe the shooter, question the shooter, look at the evidence down range, question the shooter again, make assumptions based upon the evidence available, and then act upon his assumptions. The coach and shooter must have a free and open dialog with each other in a relaxed atmosphere. Remember if a Soldier learns to shoot poorly they will only be capable of shooting poorly.

### **Displacement of Shots Within a Group (Flyers)**

E-44. The capability of the weapon to shoot groups varies dependent on the number of rounds fired through the barrel over its lifetime. The average expected group size is 1 inch (approximately 2.5 centimeters) at 25 meters; some guns may shoot slightly larger than this. If a shooter is firing groups larger than a normal group size the next step should be to have a known skilled shooter attempt to fire and group with the shooter's weapon. If a proven skilled shooter is able to fire groups of the normal size it is most likely an issue with the original shooter. If however the skilled shooter cannot fire within the accepted group size there may be something wrong with the gun or barrel.

E-45. When looking at groups where there are one to two shots away from the group body (one shot away for a three round group, one or two shots away for a five round group), the coach must look objectively at the overall consistency of group placement. A bad shot or group might not indicate a poor grasp of the elements; every shooter will have a bad shot now and again, and some shooters may even have a bad group now and again. Coaches need to use their experience and determine whether or not the firer had a bad shot, a bad group, or doesn't have a clear grasp of the elements and take the necessary steps to get the shooter to the end-state. The coach may have the firer shoot again and ignore the bad group or bad shot, instead hoping that the new group matches up with the previous shot groups or the coach may need to pull the shooter off the line and cover the basic elements. Contrary to popular belief, having a firer shoot over and over again in one sitting, until the firer GETS IT RIGHT is not a highly effective technique.

### **Bullets Dispersed Laterally on Target**

E-46. Bullets displaced in this manner could be caused by a lateral movement of the barrel due to an unnatural placement of the trigger finger on the trigger. Reasons for this could include—

- The shooter may be slightly misaligning the sights to the left and right.
- The shooter may have the sights aligned properly but may have trouble keeping the target itself perfectly centered on the tip of the front sight.
- Shooter may be closing eyes at the moment of firing or flinching.

### **Bullets Dispersed Vertically on Target**

E-47. Bullets displaced in a vertical manner could be caused by the following:

---

## Zeroing

- Shooter may be misaligning the front sight in the rear sight aperture vertically. May be caused by the shooter watching the target instead of the front sight. Happens more frequently from less stable positions (kneeling, unsupported positions) due to the natural movement of the weapon.
- Shooter may have trouble seeing the target and keeping the tip of the front sight exactly centered vertically on the target. Coach may consider using a larger target or a non-standard aiming point such as a 5-inch circle. Many shooters find it easier to find the center of a circle than a man shaped target.
- Shooter may not have good support, which causes him to readjust their position every shot and settle with the sights slightly misaligned.
- Shooter may be flinching or closing eyes at the moment of firing.
- Shooter may be breathing while firing the rifle. (This is not normally the case, most shooters instinctively hold their breath just before the moment of firing).

### Large Groups

E-48. Large groups are most commonly caused by the shooter looking at the target instead of the front sight. This causes the shooter to place the front sight in the center of the target without regard for its location in the rear sight aperture. A small misalignment of the sights will result in a large misplacement of shots downrange.

E-49. Most likely it is not a point of aim issue; most shooters will not fire when their properly aligned sights are pointed all over the target.

### Good Groups That Change Position on the Target

E-50. When the shooter has good groups but they are located at different positions on the target, there can be a number of reasons. These include the following:

- May be caused by the shooter properly aligning sights during shooting but picking up a different point of aim on the target each time.
- May be caused by the shooter settling into a position with the front sight on target but the sights misaligned. The shooter maintains the incorrect sight picture throughout the group but aligns the sights incorrectly and in a different manner during the next group. Tell the firer to focus on the front sight and have them check natural point of aim before each group.



This page intentionally left blank.



## Appendix F



### 10-Meter Boresight Offsets and 25-Meter Zero Offsets

This appendix provides the 10-meter target offsets and the 25-meter zero offsets for M16- and M4-series weapons mounted with iron sights, optics, MILES, TWSs, or aiming lasers.

“The general purpose of the 10 meter borelight offset targets and the 25m live-fire zero offset targets is to ensure the firer has properly borelighted their rifle.”

---

*Note.* The borelight is a visible laser. The purpose of boresighting is to obtain an initial setting on the firer’s sights, optics, and/or night equipment (aiming lights and TWS) to enable the firer to hit the 25m zero live-fire target when starting the zero process, resulting in efficient use of range time. Borelighting is conducted prior to live-fire zeroing. It is not a substitute for live-fire zeroing.

---

△ F-1. The boresight target shows the desired relationship between the bore of the weapon and the firer’s aiming point, which varies with the weapon/sight system combination. Different symbols are used for designating different sights/optics, and so forth. All borelighting is done at 10 meters. This is a dry-fire exercise. Sight settings based on borelight procedures must be verified with live-fire zero at 25 meters.

△ F-2. A blank, reproducible 10-meter target offset (figure F-2 on page F-3) and an example of each weapon configuration (figure F-3 on page F-4, figure F-4 on page F-9, and figure F-5 on page F-10) are provided. The M16A2 300-meter zeroing target is used for 25-meter zeroing with all weapon configurations, except when zeroing with iron sights.

### MARKING 10-METER TARGET OFFSETS

△ F-3. To mark the proper 10-meter target offsets—

- Find the correct template for the weapon configuration.
- Starting from the center of the borelight circle on the offset, count the number of squares to the desired point of aim.

**Appendix F**



**EXAMPLE**

L2.0, U2.4

Starting from the center of the borelight circle (0.0, 0.0), move left 2 squares and up 2.4 squares.

*Note.* Each template also provides a number formula for the proper offset.

- Place the appropriate symbol or mark. (See figure F-1.)

	Laser / Optic Desired Point of Impact
	MILES Laser
	AN/PEQ-2A Illuminator
	AN/PAS-13 TWS

**Legend:** MILES = Multiple-Integrated Laser Engagement System, TWS = thermal weapon sight



**Figure F-1. 10-meter target offset symbols**

- Notes.*
1. To reproduce the 10-meter target offset, obtain a copy of the blank 10-meter target offset and place the example of the weapon being used on the back. This reproducible copy can be laminated and used repeatedly.
  2. Table F-1 on page F-5 provides offset mounting information for various weapon configurations.

10-Meter Boresight Offsets and 25-Meter Zero Offsets

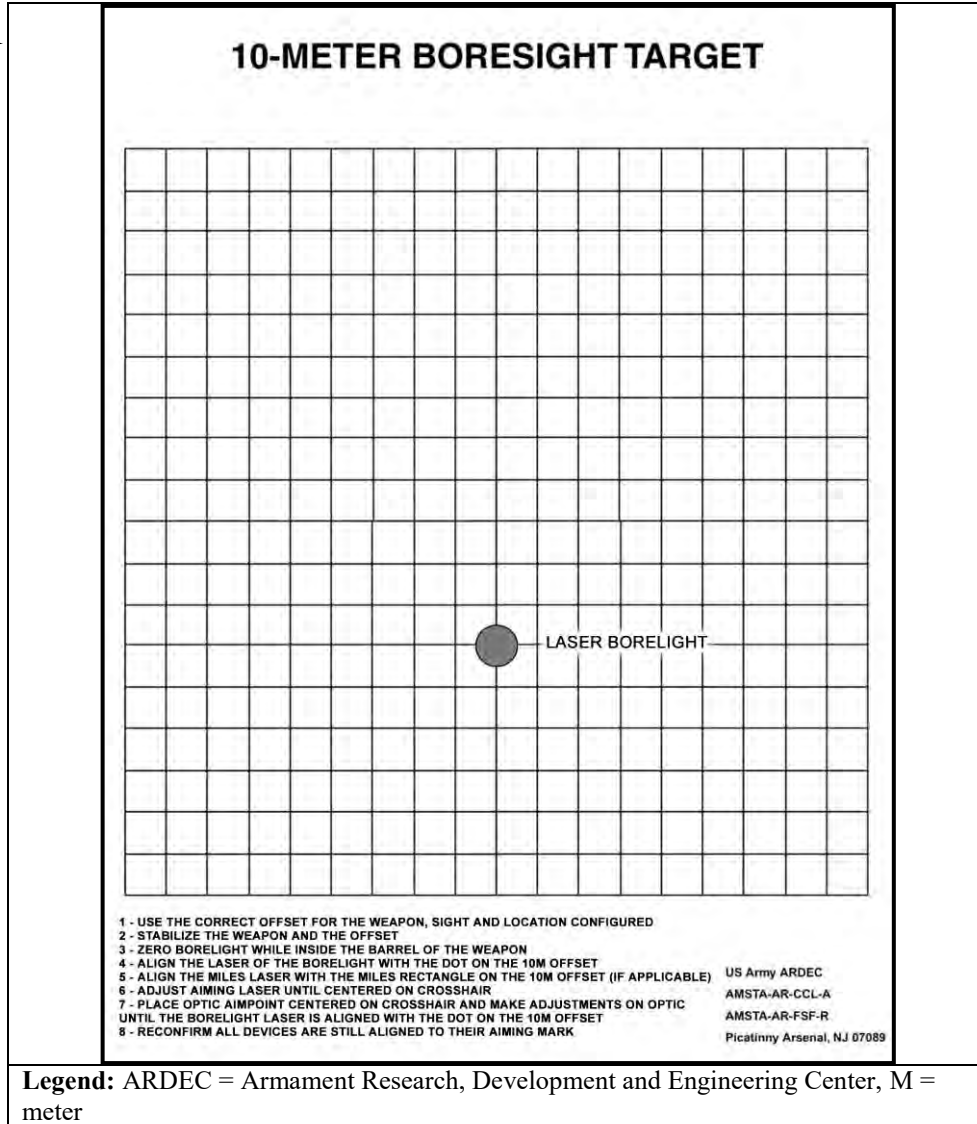
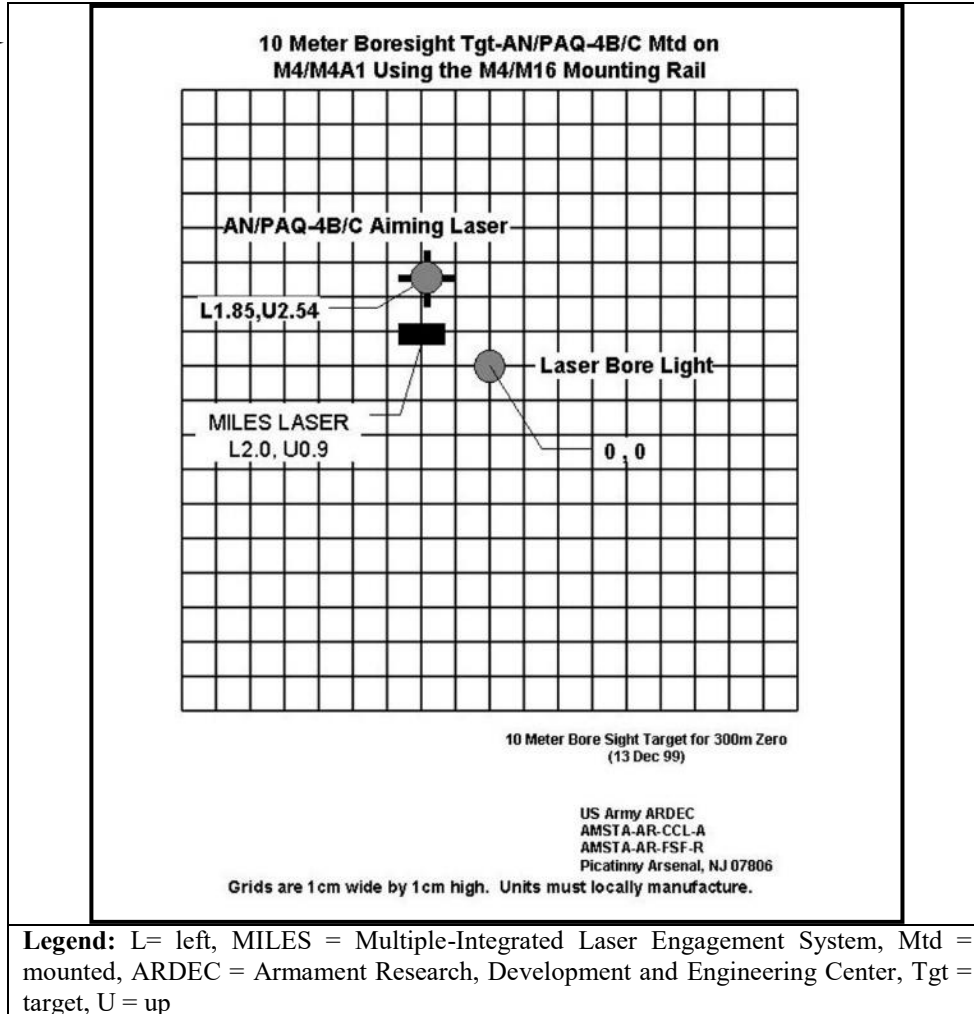

Figure F-2. Blank 10-meter target offset

Appendix F



**Figure F-3. M16A2 10-meter boresighting target**

10-Meter Boresight Offsets and 25-Meter Zero Offsets



Table F-1. Offset mounting



WEAPON	ACCESSORY	RAIL GRABBER	MOUNT	LOCATION	RANGE TO ZERO	ZERO OFFSET	BORESIGHT TARGET	MILES OFFSET
M16A2	Iron sight	N/A	N/A	N/A	300 m	0.0 0.0	0.0 4.2U	2.0L 0.9U
M16A2	M68	N/A	M68 goose-neck bracket	Carrying handle	300 m	0.0 1.4 cm DN	0.0 5.2U	2.0L 2.4U
M16A2	LTWS	TWS	TWS bracket assembly	Carrying handle	300 m	0.0 10D	0.0 13.4U	2.0L 2.4U
M16A2	TWS	N/A	TWS bracket assembly	Carrying handle	300 m	0.0 8.1D	0.0 11.5U	2.0L 2.4U
M16A2	AN/PA Q-4B/C	N/A	M4/M16 bracket	Hand guards	300 m	1.5R 0.5U	1.85L 2.54U	2.0L 0.9U
M16A2	AN/PE Q-2A/B	N/A	M4/M16 bracket	Hand guards	300 m	1.5L 0.5U	1.8R 2.4U	2.0L 0.9U
M16/M203	AN/PA Q-4B/C	N/A	Spacer	Carrying handle	300 m	1.85R 2.6D	1.85L 8.6U	2.0L 3.9U
M4/M4A1	BUIS	N/A	N/A	Upper receiver	300 m	0.0 0.0	0.0 4.01U	2.0L 0.9U
M4/M4A1	AN/PA Q-4B/C	N/A	M4/M16 bracket	Hand guards	300 m	1.5R 2.5U	1.85L 2.54U	2.0L 0.9U
M4/M4A1	LTWS	TWS	N/A	Upper receiver	300 m	0.0 4.5D	0.0 7.9U	TBD
M4/M4A1	TWS	Picatinny	TWS spacer and rail grabber	Upper receiver	300 m	0.0 5.7D	0.0 9.4U	2.0L 2.4U
M4/M4A1	AN/PE Q-2A/B	N/A	M4/M16 bracket	Hand guards	300 m	1.0L 0.3U	1.8R 2.4U	2.0L 0.9U
M4/M4A1	M68	M68	Half-moon spacer	Upper receiver	300 m	0.0 1.4 cm DN	0.0 5.63U	2.0L 2.4U
M4/M203	BUIS	N/A	N/A	Upper receiver	300 m	0.0 0.0	0.0 6.01U	2.0L 0.9U
M4/M203	AN/PA Q-4B/C	N/A	Spacer	Carrying handle	300 m	1.3R 1.9D	1.85L 8.6U	2.0L 0.9U

*Note.* Target offsets not yet developed are indicated by TBD.

**Legend:** BUIS = back up iron sight, cm = centimeters, D or DN = down, L = left, LTWS = light thermal weapon sight, m = meter, R = right, N/A = not applicable, TBD = to be developed, TWS = thermal weapon sight, U = up

**Appendix F**



**Table F-1. Offset mounting (continued)**



WEAPON	ACCESSORY	RAIL GRABBER	MOUNT	LOCATION	RANGE TO ZERO	ZERO OFFSET	BORE-SIGHT TARGET	MILES OFFSET
M4 MWS	BUIS	N/A	N/A	Upper receiver	300 m	0.0 0.0	0.0 4.01U	2.0L 0.9U
M4 MWS	M68	M68	Rail grabber	Upper receiver	300 m	0.0 1.4 cm DN	0.0 5.63U	2.0L 2.4U
M4 MWS	LTWS	TWS	N/A	Upper receiver	300 m	0.0 4.5D	0.0 7.9U	2.0L 2.4U
M4 MWS	TWS	TWS	Spacer	Upper receiver	300 m	0.0 5.7D	0.0 9.4U	2.0L 2.4U
M4 MWS	ANPEQ -2A	Insight	N/A	Left	300 m	TBD	4.5L 1.0D	2.0L 0.9U
M4 MWS	AN/PEQ -2A/B	Insight	N/A	Right	300 m	N/A	5.5R 5.4D	2.0L 0.9U
M4 MWS	AN/PEQ -2A/B	Insight	N/A	Top	300 m	1.5L 0.5D	2.9R 2.3U	2.0L 0.9U
M4 MWS	AN/PEQ -2A/B	Picatinny	Spacer	Top	300 m	N/A	1.95R 4.1U	2.0L 0.9U
M4 MWS	AN/PEQ -2A/B	Picatinny	Spacer	Right	300 m	N/A	6.35R 4.4D	2.0L 0.9U
M4 MWS	AN/PEQ -2A/B	Picatinny	Spacer	Left	300 m	6.9R 2.0U	6.2L 0.60D	2.0L 0.9U
M4MWS	AN/PEQ -2A/B	Insight	Training adapter	Top	300 m	2.0L 1.5D	N/A	2.0L 0.9U
M4 MWS	AN/PAQ -4B/C	Picatinny	AN/PA Q-4B/C bracket adapter	Top	300 m	4.9R 6.1U	1.75L 3.9U	2.0L 0.9U
M4 MWS	AN/PAQ -4B/C	Picatinny	AN/PA Q-4B/C bracket adapter (spacer)	Right	300 m	N/A	6.9R 0.9D	2.0L 0.9U
M4 MWS	AN/PAQ -4B/C	Insight	N/A	Top	300 m	N/A	1.75L 2.15U	2.0L 0.9U
M4MWS	AN/PAQ -4B/C	Insight	N/A	Right	300 m	N/A	4.35R 0.65D	2.0L 0.9U
M4MWS	AN/PAQ -4B/C	Insight	N/A	Left	300 m	N/A	4.30L 4.25D	2.0L 0.9U

**Legend:** BUIS = back up iron sight, cm = centimeters, D or DN = down, L = left, LTWS = light thermal weapon sight, m = meter, MWS = modular weapon system, R = right, N/A = not applicable, TBD = to be developed, TWS = thermal weapon sight, U = up

**10-Meter Boresight Offsets and 25-Meter Zero Offsets**



**Table F-1. Offset mounting (continued)**



WEAPON	ACCESSORY	RAIL GRABBER	MOUNT	LOCATION	RANGE TO ZERO	ZERO OFFSET	BORESIGHT TARGET	MILES OFFSET
M4 MWS M203	BUIS	N/A	N/A	Upper receiver	300 m	0.0 0.0	0.0 6.01U	2.0L 0.9U
M4 MWS M203	AN/PAQ -4B/C	Picatinny	Bracket adapter (spacer)	Left	300 m	4.9R 6.1U	6.0L 4.0D	2.0L 3.9U
M16A4 MWS	BUIS	N/A	N/A	Upper receiver	300 m	0.0 0.0	0.0 4.01U	2.0L 0.9U
M16A4 MWS	AN/PAQ -4B/C	Picatinny	AN/PAQ-4B/C bracket adapter (spacer)	Left	300 m	6.5R 8.1U	6.03L 4.25D	2.0L 0.9U
M16A4 MWS	TWS	TWS	Spacer	Upper receiver	300 m	0.0 6.0D	0.0 9.4U	2.0L 2.4U
M16A4 MWS	M68	M68	N/A	Upper receiver	300 m	0.0 1.4 cm DN	0.0 5.63U	2.0L 2.4U
M16A4 MWS	AN/PEQ -2A/B	Insight	N/A	Left	300 m	3.0R 3.0U	4.5L 1.0D	2.0L 0.9U
M16A4 MWS M203	BUIS	N/A	N/A	Upper receiver	300 m	0.0 0.0	0.0 6.01U	2.0L 0.9U
M16A4 MWS M203	AN/PAQ -4B/C	Picatinny	AN/PAQ-4B/C bracket adapter (spacer)	Left	300 m	6.5R 8.1U	6.0L 4.0D	2.0L 3.9U
M16A4 MWS	AN/PEQ -2A/B	Picatinny	Spacer	Left	300 m	6.0R 2.0U	6.2L 0.60D	2.0L 0.9U
M16A4 MWS	AN/PEQ -2A/B	Picatinny	Spacer	Right	300 m	TBD	6.35R 4.4D	2.0L 0.9U
M16A4 MWS	AN/PEQ -2A/B	Picatinny	Spacer	Top	300 m	TBD	1.95R 4.1U	2.0L 0.9U
M16A4 MWS	AN/PEQ -2A/B	Insight	N/A	Right	300 m	TBD	5.5R 5.4D	2.0L 0.9U
M16A4 MWS	AN/PEQ -2A/B	Insight	N/A	Top	300 m	1.5L 0.5D	2.0R 2.3U	2.0L 0.9U

**Note.** Target offsets not yet developed are indicated by TBD.

**Legend:** BUIS = back up iron sight, cm = centimeter, D or DN = down, m = meter, L = left, MWS = modular weapon system, R = right, N/A = not applicable, TBD = to be developed, TWS = thermal weapon sight, U = up



**Appendix F**



**Table F-1. Offset mounting (continued)**



WEAPON	ACCESSORY	RAIL GRABBER	MOUNT	LOCATION	RANGE TO ZERO	ZERO OFFSET	BORE-SIGHT TARGET	MILES OFFSET
M16A4 MWS	AN/PEQ-2A/B	Insight	Training adapter	Top	300 m	2.0L 1.5D	TBD	2.0L 0.9D
M16A4 MWS	AN/PAQ-4B/C	Picatinny	AN/PAQ-4B/C bracket adapter	Top	300 m	4.9R 6.1U	1.75L 3.9U	2.0L 0.9U
M16A4 MWS	AN/PAQ-4B/C	Picatinny	AN/PAQ-4B/C bracket adapter	Right	300 m	N/A	6.0R 0.9D	2.0L 0.9U
M16A4 MWS	AN/PAQ-4B/C	Insight	N/A	Top	300 m	N/A	1.75L 2.15U	2.0L 0.9U
M16A4 MWS	AN/PAQ-4B/C	Insight	N/A	Right	300 m	N/A	4.35R 0.65D	2.0L 0.9U
M16A4 MWS	AN/PAQ-4B/C	Insight	N/A	Left	300 m	N/A	4.30L 4.25D	2.0L 0.9U

*Note.* Target offsets not yet developed are indicated by TBD).

**Legend:** D = down, L = left, m = meter, MWS = modular weapon system, N/A = not applicable, R = right, TBD = to be developed, TWS = thermal weapon sight, U = up

10-Meter Boresight Offsets and 25-Meter Zero Offsets

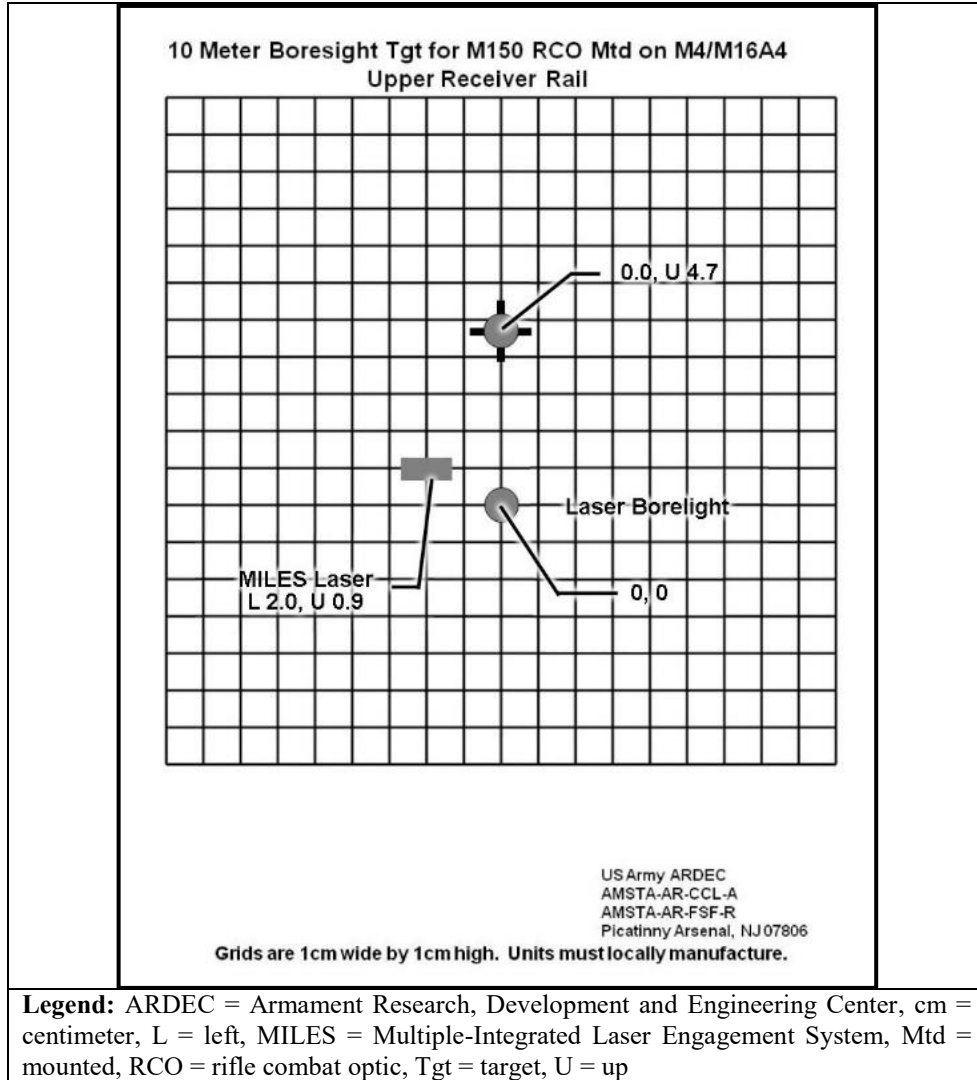

△ Figure F-4. 300-meter zero of the advanced combat optical gunsight

**Appendix F**

---

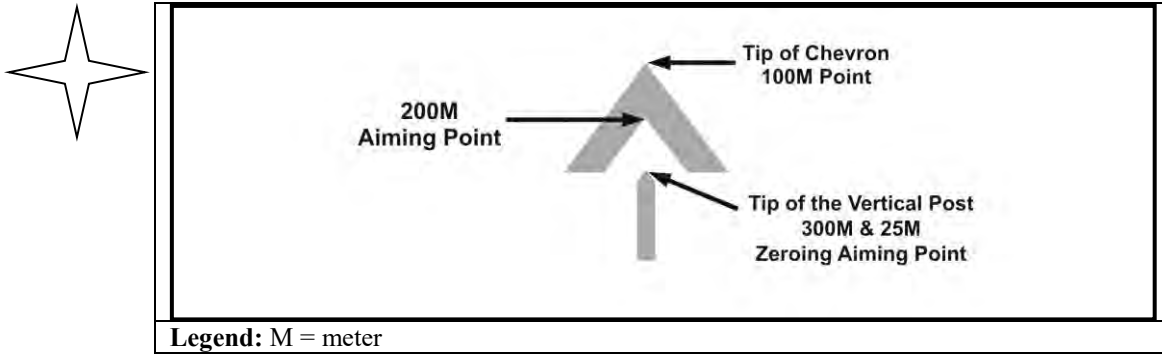

△ **Figure F-5. Advanced combat optical gunsight points of aim (100 to 300 meters)**

## Glossary

The glossary lists acronyms and terms with Army or joint definitions. Where Army and joint definitions differ, (Army) precedes the definition. Terms for which TC 3-22.9 is the proponent are marked with an asterisk. The proponent manual for other terms is listed in parentheses after the definition.

### SECTION I – ACRONYM/ABBREVIATIONS

AM	arc of movemet
ARNG	Army National Guard
ARNGUS	Army National Guard of the United States
ARS	adapter rail system
ATPIAL	advanced target pointer illuminator aiming light
BC	ballistic coefficient
BDC	bullet drop compensater
BUIS	back up iron sight
BZO	battle sight zero
CBRN	chemical, biological, radiological, and nuclear
CCO	close combat optic
CSF2	Comprehensive Soldier and Family Fitness
CoVM	center of visible mass
DA	Department of the Army
DBAL-A2	dual beam aiming laser-advanced2
DMC	digital magnetic compass
DOTD	Directorate of Training and Doctrine
DODIC	Department of Defense Identification Code
EENT	end evening nautical twilight
Ek	kinectic energy
fps	feet per second
FOV	field of view
GTL	gun target line
HTWS	heavy thermal weapons sight
I2	image intensifier
IR	infrared
LASER	light amplified stimulated emitted radiation
LCD	liquid crystal display
LRF	laser range finder
LWTS	light weapons thermal sight
MASS	modular accessory shotgun system

**Glossary**

---

MCoE	United States Army Maneuver Center of Excellence
METT-TC	mission, enemy, terrain and weather, troops and support-time available, and civil considerations
MIL STD	military standard
m	meter
mm	millimeter
mph	mile per hour
MOA	minutes of angle
MTBF	mean time between failures
MWO	modified word order
MWS	modular weapon system
MWTS	medium weapon thermal sight
NATO	North Atlantic Treaty Organization
NOD	night observation device
PAM	pamphlet
PMCS	preventative maintenance checks and services
POA	point of aim
POI	point of impact
NSN	National Stock Number
RCO	rifle combat optic
SAA	small arms ammunition
SOP	standard operating procedure
STANAG	Standardized Agreement
STRAC	Standard in Training Commission
STORM	illuminator, integrated, small arms
TACSOP	tactical standard operating procedure
TC	Training Circular
TES	tactical engagement simulation
TM	Technical Manual
T	time
TWS	thermal weapon sight
µm	micrometer
USAR	United States Army Reserve
U.S.	United States
VAL	visible aim laser
VFG	vertical foregrip
V	velocity
WCS	weapon control status
WTS	weapons thermal sights

## SECTION II – TERMS

*\*employment*

The application of the functional elements of the shot process and skills to accurately and precisely fire a weapon at stationary or moving targets.



This page intentionally left blank.

## References

URLs accessed 7 October 2019.

### REQUIRED PUBLICATIONS

- △ ADP 1-02, *Terms and Military Symbols*, 14 August 2018.
- △ *DOD Dictionary of Military and Associated Terms*, October 2019.

### RELATED PUBLICATIONS

Most Army doctrinal publications and regulations are available at:

<http://www.apd.army.mil>.

Most joint publications are available online at:

<http://www.dtic.mil/doctrine/doctrine/doctrine.htm>.

Other publications are available on the Central Army Registry on the Army Training Network, <https://atiam.train.army.mil>.

Military Standards are available online at <http://quicksearch.dla.mil/>.

ATP 3-21.8, *The Infantry Rifle Platoon and Squad of the Infantry Brigade Combat Team*, 12 April 2016.

DA PAM 350-38, *Standards in Training Commission*, 6 October 2015.

- △ FM 6-27/MCTP 11-10C, *The Commander's Handbook on the Law of Warfare*, 7 August 2019.

MIL-STD-709D, *Department of Defense Criteria Standard: Ammunition Color Coding*, 16 March 2009.

MIL-STD-1913, *Military Standard Dimensioning of Accessory Mounting Rail for Small Arms Weapons*, 3 February 1995.

TC 3-22.12, *M26 Modular Accessory Shotgun System*, 12 November 2014.

TM 9-1005-319-10, *Operator's Manual for Rifle, 5.56 MM, M16A2 W/E (NSN 1005-01-128-9936) (EIC: 4GM); Rifle, 5.56 MM, M16A3 (1005-01-357-5112); Rifle, 5.56 MM, M16A4 (1005-01-383-2872) (EIC: 4F9); Carbine, 5.56 MM, M4 W/E (1005-01-231-0973) (EIC: 4FJ); Carbine, 5.56 MM, M4A1 (1005-01-382-0953) (EIC: 4GC) {TO 11W3-5-5-41; SW 370-BU-OPI-010}*, 30 June 2010.

TM 9-1240-413-13&P, *Operator and Field Maintenance Manual Including Repair Parts and Special Tool List for M68 Sight, Reflex, w/Quick Release Mount and Sight Mount Close Combat Optic (CCO) (NSN 1240-01-411-1265) (NSN 1240-01-540-3690) (NSN 1240-01-576-6134) {AF TO 11W3-5-5-121}*, 4 May 2013.

TM 9-1240-416-13&P, *Operator and Field Maintenance Manual Including Repair Parts and Special Tool List for the M150 Sight, Rifle Combat Optic (RCO) (NSN: 1240-01-557-1897)*, 21 June 2013.



## References

---

- TM 9-1300-200, *Ammunition, General*, 3 October 1969.
- TM 9-1305-201-20&P, *Unit Maintenance Manual (Including Repair Parts and Special Tools List) for Small Arms Ammunition to 30 Millimeter Inclusive (Federal Supply Class 1305)*, 5 October 1981.
- TM 9-5855-1912-13&P, *Operator and Field Maintenance Manual Including Repair Parts and Special Tools List for Dual Beam Aiming Laser-Advanced2 (DBAL-A2), AN/PEQ-15A (NSN: 5855-01-535-6166) (NSN: 5855-01-579-0062) (LIN: J03261)*, 1 September 2012.
- TM 9-5855-1913-13&P, *Operator and Field Maintenance Manual Including Repair Parts and Special Tools List for the Illuminator, Integrated, Small Arms (STORM) AN/PSQ-23 TAN (NSN: 5855-577-5946 (4XG) (NSN: 5855-01-535-1905) (EIC: 4XF) (LIN: J68653)*, 31 August 2012.
- TM 9-5855-1914-13&P, *Operator and Field Maintenance Manual Including Repair Parts and Special Tools List for the Advanced Target Pointer Illuminator Aiming Light (ATPIAL) AN/PEQ-15 (NSN 5855-01-534-5931) (NSN 5855-01-577-7174) {TM 10470B-01/1}*, 10 September 2012.
- TM 9-5855-1915-13&P, *Operator and Field Maintenance Manual (Including Repair Parts and Special Tools List) for the Target Pointer Illuminator/Aiming Light (TPIAL) AN/PEQ-2A (NSN: 5855-01-447-8992) (EIC: N/A) AN/PEQ-2B (5855-01-515-6904) (EIC: N/A) {TM 10470A-01/1}*, 31 August 2007.
- TM 11-5855-306-10, *Operator Manual for Monocular Night Vision Device (MNVD) AN/PVS-14 (NSN 5855-01-432-0524) (EIC: IPX) {TO 12S10-2PVS14-1; TM 10271A-OR/1B}*, 1 October 2010.
- TM 11-5855-312-10, *Operator's Manual for Sight, Thermal AN/PAS-13B(V)2 (NSN 5855-01-464-3152) (EIC:N/A); AN/PAS-13B(V)3 (5855-01-464-3151) (EIC:N/A) {TM 10091B/10092B-10/1}*, 15 February 2005.
- TM 11-5855-316-10, *Operator's Manual AN/PAS-13C(V)1 Sight, Thermal (NSN 5855-01-523-7707) (EIC: N/A) AN/PAS-13C(V)2 Sight, Thermal (NSN 5855-01-523-7713) (EIC: N/A) AN/PAS-13C(V)3 Sight, Thermal (NSN 5855-01-523-7715) (EIC: N/A)*, 31 August 2010.
- TM 11-5855-317-10, *Operator's Manual for Sight, Thermal AN/PAS-13D(V)2 (NSN 5855-01-524-4313) (EIC: JH5) (MWTS) AN/PAS-13D(V)3 (NSN 5855-01-524-4314) {TM 10091C/10092C-OR/1}*, 15 May 2009.
- TM 11-5855-324-10, *Operator's Manual for Sight, Thermal AN/PAS-13D(V)1 (NSN 5855-01-524-4308) (EIC: JG8) (LWTS)*, 15 May 2009.



## PRESCRIBED FORMS

No entries for this section.

---

**References**

**REFERENCED FORMS**

Unless otherwise indicated, DA forms are available on the Army Publishing Directorate (APD) web site (<http://www.apd.army.mil>).

DA Form 2028, *Recommended Changes to Publications and Blank Forms*.

This page intentionally left blank.

# Index

Entries are listed by paragraph numbers unless mentioned otherwise.



## C

carry positions  
six. 6-12  
coaching  
elements of  
shooting. E-30  
aiming. E-32  
control. E-34  
stabilize. E-31  
two types. E-27

## F

firing positions  
twelve. 6-34

## M

movement techniques

horizontal

eight. 9-3

## S

small arms ammunition.  
A-14

## T

targets  
three threat levels,  
5-7  
thermal weapon sight  
five functional  
groups. 3-42

This page intentionally left blank.

**TC 3-22.9**  
**13 May 2016**

By Order of the Secretary of the Army:

**MARK A. MILLEY**  
*General, United States Army*  
*Chief of Staff*

Official:



**GERALD B. O'KEEFE**  
*Administrative Assistant to the*  
*Secretary of the Army*  
1612002

**DISTRIBUTION:** Active Army, Army National Guard, and U.S. Army Reserve: To be distributed in accordance with the initial distribution number (IDN) 110187, requirements for TC 3-22.9.



**PIN: 106419-000**



# **EXHIBIT 5**



**PSYCHOLOGICAL EFFECTS OF SMALL ARMS FIRE ON COMBAT  
EXPERIENCED AND NON-EXPERIENCED INFANTRYMEN**

**USAOTEA  
TECHNICAL LIBRARY**

OCT 24 1980

Research Study Report III

ACCESSION NO 002506  
AD-\_\_\_\_\_

**DTIC USERS ONLY**

John Whittenburg  
James Whitehouse

Military Project Officer  
1/Lt Cecil Walker

Data Analyst  
Sp. 3 Joseph Yance

**Reproduced From  
Best Available Copy**

Psychological Research Associates  
507 Eighteenth Street, South  
Arlington 2, Virginia

PRA Report 57-9                      June 1957

19981103 036

Technical Library                      Bldg 2925  
Special Developments Command  
Naval Air Station Command  
Moffett Field, California 94035

U-2506

PSYCHOLOGICAL EFFECTS OF SMALL ARMS FIRE ON COMBAT  
EXPERIENCED AND NON-EXPERIENCED INFANTRYMEN

A. PURPOSE

This report presents one of a series of studies of the psychological effect of small arms fire conducted as part of the Platoon Organization Studies research program.<sup>1</sup> Prior studies on the psychological effects of small arms fire (reported in Psychological Research Associates Research Memorandum 56-6, March 1956), investigated the judged dangerousness of fire of the semi-automatic and automatic rifles for various volumes of fire delivered at various overhead and lateral distances from infantry troops. Those studies tested separately the psychological effectiveness (judged dangerousness) of the M1 rifle and the automatic rifle on groups of randomly selected infantrymen. The study reported here is a continuation of this prior work.

This study was undertaken to determine the relationship between combat experience and neutralizing effects of a given amount and placement of small arms fire. Combat experienced infantrymen were compared with infantrymen without combat experience in terms of their judgments of the dangerousness of M1 and AR fire.

The major variables of the study were:<sup>2</sup>

Observer Personnel: Combat experienced vs. inexperienced personnel  
(15 in each group).

Weapons: M1 vs. AR.

Volumes Per Six  
Seconds: 4, 12 and 24 rounds

Distances From  
Observer: 0, 12 and 24 feet lateral distances

---

<sup>1</sup> The Platoon Organization Studies research program is being conducted by Psychological Research Associates for Combat Operations Research Group, Continental Army Command and Research Office, Experimentation Center as part of the Combat Development Experimentation Center research effort. The study reported here was conducted at Fort Benning, Georgia, in July 1956.

<sup>2</sup> The distances and volumes were selected on the basis of results of prior studies as easily discriminable distances and volumes for each of the two weapons being studied. See Psychological Research Associates Research Memorandum 56-6.

## B. PROCEDURES

### 1. Range Layout

The study was conducted on a flat transition range at Fort Benning, Georgia. Observers were located 100 yards down range from the firing line in a 7' x 4' x 30' pit with overhead cover but open to the rear. Five aiming point targets were positioned 12 feet apart laterally along the top of the pit, with the bottom edge of the targets approximately 3 feet from the ground.

### 2. Participating Troops

Thirty men of the 29th Infantry Regiment served as observers. One-half of this group had front line rifle company combat experience in World War II or in Korea or both. The average time in combat was 16.3 months. The other 15 men had had no combat experience.

Six experienced riflemen and six experienced automatic riflemen participated as firers.

### 3. Test Administration Procedures

a. Phase I: Comparative Judgments. All trials of Phase I consisted of the firing of two six-second patterns of fire, one from an M1 and one from an AR. All volume/distance combinations for the M1 were paired with all volume/distance combinations for the AR. Each trial was fired twice, one with the AR first and once with the M1 first. There was a three-second interval between the first and second halves of each trial and a thirty-second interval between successive trials. Subjects were seated in a double row underneath the center target (which was considered "zero" feet lateral distance from subjects).<sup>1</sup> The observer's task for each trial was to imagine himself in combat and to judge which of the two fire patterns of the trial he thought to be most dangerous to him. Each observer made independent judgments for each trial and recorded them on a standard form. (See Appendix I.)

b. Phase II: Action Judgments. Trials of Phase II consisted of the firing of one six-second pattern of fire from one or the other of the two weapons. There were several trials for each volume/distance combination for each of the two weapons. Trials were thirty seconds apart. Observers were positioned in three five-man groups below the three center targets. The

---

<sup>1</sup> During the course of the firing in Phase I, the same volume/distance combinations were fired to the left and right of the center aiming point at positions 12 and 24 feet away from the center aiming point to attempt to eliminate possible directional bias and to minimize the effect of the lateral distance an individual would be offset from the "zero" by his position in the group. (See Appendix III for order of firing conditions during Phase I.)

observer's task for Phase II trials was to imagine himself in combat and indicate his most likely response to the fire in terms of the five point scale below:

- (1) Take cover and stay down.
- (2) Take cover and pop up every now and then to fire quickly.
- (3) Take cover, then return sustained fire.
- (4) Take cover, then fire and move forward in short rushes.
- (5) Keep moving forward and return fire.

(See Appendix II.)

c. Presentation and Control of Fire Patterns. For each trial, a fire control officer specified the men who should fire and their target, according to a pre-set firing schedule. (See Appendix III and IV.) Each man fired four rounds per trial. Volume of fire was systematically varied by varying the number of firers per trial. AR men attempted to fire two-round bursts. A metronome and count system were used to insure that the required volume of fire was uniformly distributed throughout the six-second firing period.

#### 4. Data Processing and Analysis

Comparative judgments (Phase I) were combined for the 15 firers of each group to obtain percentages of times that the AR was judged more dangerous than the M1 for each volume/distance combination for each group of observers.

The five response categories for action judgments (Phase II) were assigned arbitrary score values 1, 2, 3, 4 and 5; higher numbers indicating least neutralization. The judgments of the fifteen members of each group were averaged for each weapon-volume-distance combination. These data were submitted to an analysis of variance to determine which factors (combat experience, weapons, volume, distance) and which combinations of those factors made significant differences in action judgments.<sup>1</sup>

### C. RESULTS

1. Phase I: Comparative Judgments. The percentages of judgments of AR as more dangerous than M1 as a function of differences in volume of fire and distance of fire from observers are shown for combat and non-combat groups in Table 1. For equal volumes and distances, the AR is generally judged more dangerous than the M1 by both groups of observers. (See Table 1 and Appendix V.)

---

<sup>1</sup> Used here is an extension of the analysis of variance model described in Lindquist, E.F., Design and Analysis of Experiments, Houghton Mifflin Co., Boston, 1953, p. 292ff.

TABLE 1

PROPORTION JUDGING AR FIRE MORE DANGEROUS THAN  
M1 FIRE FOR EQUIVALENT VOLUME-DISTANCE COMBINATIONS

VOLUME (per 6 seconds)

		4	12	24	
DISTANCE (Ft.)	0	.63	.45	.43	COMBAT GROUP  N = 60
	12	.58	.58	.58	
	24	.68	.58	.60	

VOLUME (per 6 seconds)

		4	12	24	
DISTANCE (Ft.)	0	.28	.67	.55	NON-COMBAT GROUP  N = 60
	12	.50	.67	.65	
	24	.42	.60	.72	

2. Phase II: Action Judgments. The relationships between action judgments and weapons-volume-distance-experience combinations are summarized in Table 2. The lower the scale value, the greater the neutralization. Results of the analysis of variance of action response judgments show the following factors and combinations of factors to be significant in determination of psychological effectiveness of fire: (See Table 3 and Appendix VI.)

a. Degree of Combat Experience. Combat experienced personnel were neutralized less than were non-experienced personnel.

b. Weapons. The automatic rifle was judged more psychologically effective than the semi-automatic rifle.

c. Volume. Increases of volume of fire per six-second interval produced increases in judged neutralization effects.

d. Distance. Decreases in distance of fire from the observer increased the judged neutralization effects of the fire.

e. Weapon and Volume. Increases in volume of fire of the automatic rifle produced greater increases in judged neutralization than equal increases in volume of fire of the semi-automatic rifle.

f. Combat Experience and Distance. Decreases in distance produced greater increases in judged neutralization for the combat experienced group than for the non-experienced group.

#### D. CONCLUSIONS

The major results of this experiment lead to the following conclusions:

1. The automatic rifle has significantly greater psychological effect than the semi-automatic rifle. This conclusion is supported by results from both the comparative judgments method and the absolute judgments method and is consistent with results of prior studies.<sup>1</sup>

2. The degree of psychological effectiveness of both weapons is a function of the volume of fire, the nearness of the fire, and the combat experience of the infantrymen.

---

<sup>1</sup> See PRA Research Memorandum 56-6, March 1956.

TABLE 2

AVERAGE ACTION JUDGMENT VALUES

COMBAT - AR<sup>1</sup>

Distance

		24	12	0	Av.
VOLUME (rounds per 6 seconds)	4	3.8	4.0	3.4	3.7
	12	3.3	3.0	2.8	3.0
	24	2.7	2.1	1.6	2.1
	Av.	3.3	3.0	2.6	

COMBAT - M1

Distance

		24	12	0	Av.
VOLUME (rounds per 6 seconds)	4	4.4	4.4	4.2	4.3
	12	3.4	3.2	2.9	3.2
	24	3.0	2.6	2.0	2.8
	Av.	3.6	3.4	3.0	

NON-COMBAT - AR

Distance

		24	12	0	Av.
VOLUME (rounds per 6 seconds)	4	3.3	3.6	3.4	3.4
	12	2.4	2.4	2.2	2.3
	24	1.5	1.5	1.4	1.5
	Av.	2.4	2.5	2.3	

<sup>1</sup> The lower the mean value, the greater the degree of neutralization

TABLE 2 (Cont'd)

AVERAGE ACTION JUDGMENT VALUES

NON-COMBAT - M1

Distance

24 12 0 Av.

VOLUME (rounds per  
6 seconds)

4	4.0	3.9	4.1	4.0
12	2.6	2.7	2.5	2.6
24	1.9	2.0	1.5	1.8
Av.	2.8	2.9	2.7	



TABLE 3

MEANS OF ACTION JUDGMENT VALUES AND SIGNIFICANCE OF MEAN DIFFERENCES FOR ALL CONDITIONS

<u>CONDITIONS</u>		<u>MEAN</u>		<u>P</u>
<u>Experience</u>				.005
	Combat	3.15		
	Non-Combat	2.59		
<u>Weapons</u>				.005
	M1	3.06		
	BAR	2.68		
<u>Volume</u>				.005
	4	3.87		
	12	2.77		
	24	1.97		
<u>Distance</u>				.005
	24	3.03		
	12	2.93		
	0	2.65		
<u>Experience x Distance</u>		<u>Combat</u>	<u>Non-Combat</u>	.01
	Distance 0	2.8	2.5	
	12	3.2	2.7	
	24	3.5	2.6	
<u>Weapon x Volume</u>		<u>M1</u>	<u>BAR</u>	.025
	Volume 4	3.6	4.2	
	12	2.7	2.9	
	24	1.8	2.3	

<sup>1</sup> Tests of significance based on analysis of variance of action judgment values.

Appendix I

EXAMPLE DATA RECORDING SHEET FOR COMPARATIVE JUDGMENTS  
(Phase I)

Name \_\_\_\_\_ ASN \_\_\_\_\_ Rank \_\_\_\_\_

Do you have combat experience as a member of a front line rifle company? \_\_\_\_\_

Do you have the Combat Infantryman's Badge? \_\_\_\_\_ In what war did you get combat experience? \_\_\_\_\_ Where? \_\_\_\_\_ How long? \_\_\_\_\_ What was your rank in combat? \_\_\_\_\_

Instructions: Before each pair of firings, the NCO in the pits will call out the trial number. Record this in the blank provided to the left of each column. After the pairings have been fired, indicate by writing either 1 or 2, which of the firings, the first or the second you consider the most dangerous.

Table with 12 rows and 3 columns of horizontal lines for recording data.

Appendix II

EXAMPLE DATA RECORDING SHEET FOR ACTION JUDGMENTS  
(Phase II)

Name \_\_\_\_\_ ASN \_\_\_\_\_ Rank \_\_\_\_\_ Group No. \_\_\_\_\_

Do you have combat experience as a member of a front line rifle company? \_\_\_\_\_

Do you have the Combat Infantryman's Badge? \_\_\_\_\_ In what war did you get combat experience? \_\_\_\_\_ Where? \_\_\_\_\_ How long? \_\_\_\_\_ What was your rank in combat? \_\_\_\_\_

Instructions: This test will require you to imagine yourself in combat as a rifleman. There will be single firings (lasting six seconds). You must decide which of the numbered actions listed below you would take if you were in combat and record that in the proper numbered blank. The first number of each blank indicates the trial number which the NCO in charge will tell you before each firing. Remember to record the number of the action you would most likely take. If none of them is exactly what you would do, record the number of the action which is closest to the way you would act. Do not make up any new actions and do not record any numbers other than the ones called for by the scaled actions. The scale to use is printed below. The number you are to record for the action you select for each burst is written to the left of the statement.

1. Take cover and stay down.
2. Take cover and pop up every now and then to fire quickly.
3. Take cover and return sustained fire.
4. Take cover, then fire and move forward in short rushes.
5. Keep moving forward and return fire.

---

1. _____	10. _____	19. _____	28. _____	37. _____
2. _____	11. _____	20. _____	29. _____	38. _____
3. _____	12. _____	21. _____	30. _____	39. _____
4. _____	13. _____	22. _____	31. _____	40. _____
5. _____	14. _____	23. _____	32. _____	41. _____
6. _____	15. _____	24. _____	33. _____	42. _____
7. _____	16. _____	25. _____	34. _____	43. _____
8. _____	17. _____	26. _____	35. _____	44. _____
9. _____	18. _____	27. _____	36. _____	45. _____

Phase II (Continued)

46. _____	57. _____	67. _____	77. _____	87. _____
47. _____	58. _____	68. _____	78. _____	88. _____
48. _____	59. _____	69. _____	79. _____	89. _____
49. _____	60. _____	70. _____	80. _____	90. _____
50. _____	61. _____	71. _____	81. _____	91. _____
51. _____	62. _____	72. _____	82. _____	92. _____
52. _____	63. _____	73. _____	83. _____	93. _____
53. _____	64. _____	74. _____	84. _____	94. _____
54. _____	65. _____	75. _____	85. _____	95. _____
55. _____	66. _____	76. _____	86. _____	96. _____
56. _____				

Appendix III

FIRING SCHEDULE FOR COMPARATIVE JUDGMENTS  
(Phase I)

- |      |            |       |            |      |            |       |            |
|------|------------|-------|------------|------|------------|-------|------------|
| 1.   | 24/24-ML/R | ....  | 24/24-AR/R | 41.  | 4/24-ML/R  | ....  | 12/24-AR/L |
| 2.   | 4/O-AR     | ..... | 4/O-ML     | 42.  | 4/12-AR/L  | ....  | 24/24-ML/R |
| *3.  | 12/O-ML    | ..... | 4/12-ML/R  | 43.  | 12/24-AR/L | ...   | 12/24-ML/L |
| 4.   | 24/24-ML/L | ....  | 24/12-AR/R | 44.  | 12/12-ML/R | ...   | 12/12-AR/R |
| 5.   | 24/24-ML/L | ....  | 24/O-AR/L  | 45.  | 24/12-ML/L | ...   | 24/12-AR/R |
| *6.  | 4/12-AR/R  | ..... | 24/24-AR/R | 46.  | 4/24-AR/R  | ....  | 4/24-ML/L  |
| 7.   | 4/O-AR     | ..... | 4/12-ML/L  | 47.  | 4/O-ML     | ..... | 4/O-AR     |
| 8.   | 24/24-AR/L | ....  | 12/24-ML/R | *48. | 4/12-ML/L  | ....  | 24/24-ML/R |
| 9.   | 4/O-ML     | ..... | 4/24-AR/L  | 49.  | 12/24-AR/L | ...   | 12/24-ML/L |
| 10.  | 4/O-AR     | ..... | 12/O-ML    | 50.  | 24/O-ML    | ..... | 24/O-AR    |
| 11.  | 24/24-ML/L | ....  | 12/12-AR/L | 51.  | 4/12-AR/R  | ....  | 4/12-ML/L  |
| 12.  | 24/24-AR/L | ....  | 12/O-ML    | *52. | 12/O-AR    | ..... | 4/12-AR/L  |
| 13.  | 24/24-AR/R | ....  | 4/24-ML/L  | 53.  | 24/24-ML/L | ...   | 24/24-AR/L |
| 14.  | 4/O-ML     | ..... | 12/12-AR/R | 54.  | 12/O-ML    | ..... | 12/O-AR    |
| 15.  | 24/24-AR/R | ....  | 4/12-ML/R  | 55.  | 4/24-AR/R  | ....  | 4/24-ML/R  |
| 16.  | 4/O-ML     | ..... | 12/24-AR/L | 56.  | 24/12-AR/L | ...   | 12/24-ML/R |
| 17.  | 4/O-ML     | ..... | 24/O-AR    | 57.  | 12/O-ML    | ..... | 4/24-AR/R  |
| *18. | 12/O-ML    | ..... | 4/12-ML/L  | 58.  | 12/O-AR    | ..... | 4/12-ML/L  |
| 19.  | 24/24-ML/L | ....  | 4/O-AR     | *59. | 12/O-ML    | ..... | 24/24-ML/L |
| 20.  | 4/O-AR     | ..... | 24/12-ML/L | 60.  | 12/12-ML/L | ...   | 24/24-AR/L |
| 21.  | 24/12-ML/R | ....  | 24/24-AR/L | 61.  | 4/24-ML/L  | ....  | 12/12-AR/R |
| 22.  | 24/12-AR/R | ....  | 24/12-ML/L | 62.  | 12/O-AR    | ..... | 24/12-ML/R |
| 23.  | 4/O-AR     | ..... | 24/24-ML/R | 63.  | 12/24-ML/R | ...   | 24/24-AR/R |
| 24.  | 24/12-ML/L | ....  | 24/O-AR    | 64.  | 12/24-AR/L | ...   | 4/12-ML/R  |
| 25.  | 4/12-AR/L  | ..... | 4/O-ML     | 65.  | 24/12-AR/R | ...   | 4/24-ML/R  |
| 26.  | 4/12-ML/R  | ..... | 4/12-AR/R  | 66.  | 24/O-ML    | ..... | 12/24-AR/L |
| *27. | 12/O-AR    | ..... | 4/12-AR/R  | 67.  | 12/12-ML/L | ...   | 4/12-AR/L  |
| 28.  | 4/12-AR/L  | ..... | 4/24-ML/L  | 68.  | 4/12-AR/L  | ....  | 12/24-ML/R |
| 29.  | 12/O-ML    | ..... | 12/12-AR/L | 69.  | 12/O-ML    | ..... | 4/O-AR     |
| 30.  | 12/O-ML    | ..... | 12/24-AR/R | 70.  | 24/O-AR    | ..... | 4/O-ML     |
| 31.  | 24/O-AR    | ..... | 4/24-ML/R  | 71.  | 12/12-ML/R | ...   | 24/O-AR    |
| 32.  | 12/12-AR/R | ....  | 12/24-ML/R | *72. | 12/O-AR    | ..... | 24/24-AR/R |
| 33.  | 12/24-ML/L | ....  | 12/O-AR    | 73.  | 12/12-AR/R | ...   | 12/12-ML/L |
| 34.  | 12/O-AR    | ..... | 12/O-ML    | 74.  | 24/12-AR/L | ...   | 4/O-ML/L   |
| 35.  | 4/24-ML/L  | ..... | 12/O-AR    | 75.  | 24/12-AR/L | ...   | 12/12-ML/R |
| 36.  | 24/O-ML    | ..... | 4/12-AR/L  | 76.  | 4/24-ML/R  | ....  | 24/O-AR    |
| 37.  | 12/24-AR/R | ....  | 24/O-ML    | 77.  | 12/12-ML/L | ...   | 4/O-AR     |
| 38.  | 12/12-AR/L | ....  | 12/O-ML    | 78.  | 4/24-AR/L  | ....  | 4/12-ML/R  |
| 39.  | 12/24-ML/L | ....  | 4/O-AR     | 79.  | 4/12-ML/R  | ....  | 12/O-AR    |
| 40.  | 4/24-AR/R  | ..... | 24/12-ML/R | 80.  | 12/24-AR/L | ...   | 4/24-ML/L  |

KEY: First number - Volume of fire.  
 Second number - Distance from observers.  
 Third designation - Weapon type.  
 Fourth designation - Left, right, or center aiming point.

\* Indicates an experimental control trial.



Phase I (Continued)

81.	12/12-AR/R	....	24/12-ML/L	126.	24/12-ML/L	....	4/24-AR/L
82.	12/12-ML/R	....	4/24-AR/L	127.	24/0-AR	.....	12/24-ML/L
83.	24/12-ML/L	....	12/0-AR	128.	12/12-AR/R	....	4/12-ML/R
84.	24/0-AR	.....	24/0-ML	*129.	4/12-AR/L	.....	24/24-AR/L
85.	4/12-AR/R	.....	24/12-ML/R	130.	4/12-ML/R	.....	12/24-AR/R
86.	24/12-ML/L	....	4/12-AR/L	131.	12/0-AR	.....	4/0-ML
*87.	4/12-ML/R	.....	24/24-ML/R	132.	24/0-ML	.....	4/0-AR
88.	12/24-AR/L	....	12/12-ML/R	133.	12/12-AR/L	....	24/0-ML
*89.	4/12-AR/L	.....	24/24-AR/R	134.	12/12-ML/R	....	12/12-AR/R
90.	24/0-ML	.....	24/24-AR/L	135.	24/12-ML/L	....	4/0-AR
91.	4/24-ML/L	.....	24/24-AR/R	136.	24/12-ML/R	....	12/12-AR/L
92.	24/0-AR	.....	24/12-ML/R	137.	4/24-AR/L	.....	24/0-ML
93.	12/0-ML	.....	24/0-AR	138.	12/12-AR/R	....	4/0-ML
94.	4/24-AR/R	.....	4/0-ML	139.	4/24-ML/R	.....	4/12-AR/L
95.	12/0-AR	.....	24/24-ML/L	140.	4/12-AR/L	.....	12/0-ML
96.	24/0-ML	.....	12/12-AR/R	141.	12/24-ML/L	....	4/24-AR/L
*97.	12/0-ML	.....	24/24-ML/R	142.	12/12-ML/L	....	24/12-AR/R
98.	12/24-AR/R	....	24/12-ML/L	143.	12/12-AR/R	....	4/24-ML/L
99.	24/0-ML	.....	12/0-AR	*144.	12/0-ML	.....	4/12-ML/R
100.	4/12-ML/R	.....	24/0-AR	145.	24/12-AR/R	....	12/0-ML/L
101.	4/12-AR/R	.....	12/12-ML/L	146.	24/0-ML	.....	24/0-AR
102.	24/24-AR/L	....	12/24-ML/R	147.	4/12-ML/L	.....	24/12-AR/R
103.	4/0-ML	.....	4/24-AR/L	148.	24/12-AR/L	....	4/12-ML/L
104.	4/0-AR	.....	12/0-ML	149.	12/24-ML/R	....	12/12-AR/R
105.	24/24-ML/L	....	12/12-AR/L	150.	24/0-AR	.....	24/24-ML/L
106.	24/24-AR/L	....	12/0-ML	151.	4/24-AR/R	.....	24/24-ML/R
107.	24/24-AR/R	....	4/24-ML/L	152.	24/0-ML	.....	24/12-AR/R
108.	4/0-ML	.....	12/12-AR/R	153.	12/0-AR	.....	24/0-ML
109.	24/24-AR/R	....	4/12-ML/R	154.	4/24-ML/L	.....	4/0-AR
110.	4/0-ML	.....	12/24-AR/L	155.	12/0-ML	.....	24/24-AR/L
111.	4/0-ML	.....	24/0-AR	156.	24/0-AR	.....	12/12-ML/L
*112.	4/12-ML/L	.....	24/24-ML/L	157.	12/24-ML/R	....	24/12-AR/R
113.	4/12-ML/L	.....	4/12-AR/R	*158.	12/0-ML	.....	24/24-ML/L
114.	24/24-AR/L	....	24/24-ML/L	*159.	12/0-AR	.....	4/12-AR/R
115.	12/0-AR	.....	12/0-ML	160.	24/0-AR	.....	12/0-ML
116.	4/24-ML/L	.....	4/24-AR/L	161.	4/12-AR/R	.....	24/0-ML
117.	24/12-ML/R	....	12/24-AR/L	162.	4/12-ML/L	.....	12/12-AR/R
118.	12/0-AR	.....	4/24-ML/R	163.	24/0-AR	.....	24/0-ML
119.	12/0-ML	.....	4/12-AR/R	*164.	12/0-AR	.....	24/24-AR/L
120.	12/12-AR/R	....	24/24-ML/R	165.	12/24-ML/R	....	12/24-AR/R
121.	4/24-AR/L	.....	12/12-ML/R	166.	4/0-AR	.....	4/0-ML
*122.	12/0-AR	.....	24/24-AR/L	167.	4/24-ML/L	.....	4/24-AR/L
123.	12/0-ML	.....	24/12-AR/R	168.	24/12-AR/R	....	24/12-ML/R
124.	12/24-AR/R	....	24/12-ML/L	169.	12/12-AR/R	....	12/12-ML/L
125.	12/24-ML/R	....	4/12-AR/L	170.	12/24-ML/L	....	12/24-AR/R

Phase I (Continued)

171.	24/12-ML/R	....	24/24-AR/R	216.	4/0-ML	.....	4/24-AR/L
172.	4/24-AR/R	.....	12/24-ML/L	217.	4/0-AR	.....	12/0-ML
173.	4/24-ML/R	.....	24/12-AR/L	218.	24/24-ML/L	....	12/12-AR/L
174.	12/24-AR/L	....	4/0-ML	219.	24/24-AR/L	....	12/0-ML
175.	12/12-ML/R	....	12/0-AR	220.	24/24-AR/R	....	4/24-ML/L
176.	12/24-ML/L	....	24/0-AR	221.	4/0-ML	.....	12/12-AR/R
177.	24/0-AR	.....	4/12-ML/R	222.	24/24-AR/R	....	4/12-ML/R
178.	4/24-AR/R	.....	12/0-ML	223.	4/0-ML	.....	12/24-AR/L
179.	12/0-ML	.....	12/0-AR	224.	4/0-ML	.....	24/0-AR
180.	12/24-AR/L	....	12/0-ML				
181.	12/12-ML/R	....	12/24-AR/R				
182.	24/0-ML	.....	4/24-AR/L				
183.	12/0-AR	.....	12/24-ML/R				
184.	12/0-AR	.....	12/12-ML/L				
185.	4/12-ML/R	.....	4/24-AR/R				
*186.	4/12-AR/R	.....	24/24-AR/L				
187.	4/12-AR/L	.....	4/12-ML/L				
188.	4/12-ML/R	.....	4/0-AR				
189.	24/12-AR/R	....	24/0-ML				
*190.	12/0-ML	.....	24/24-ML/R				
191.	4/0-ML	.....	24/24-AR/R				
192.	24/12-ML/R	....	24/12-AR/L				
*193.	12/0-AR	.....	4/12-AR/L				
194.	24/12-AR/L	....	24/24-ML/R				
195.	4/0-ML	.....	24/12-AR/L				
196.	24/24-AR/R	....	4/0-ML				
197.	4/0-AR	.....	24/0-ML				
*198.	12/0-ML	.....	4/12-ML/L				
199.	4/0-AR	.....	12/24-ML/R				
200.	24/24-ML/R	....	4/12-AR/R				
201.	4/0-AR	.....	12/12-ML/L				
202.	24/24-ML/L	.....	4/24-AR/R				
*203.	4/12-ML/R	.....	24/24-ML/L				
204.	24/24-ML/R	....	12/0-AR/R				
205.	24/24-AR/L	....	12/12-ML/R				
206.	4/0-ML	.....	12/0-AR				
207.	4/0-AR	.....	4/24-ML/L				
208.	24/24-ML/R	....	12/24-AR/L				
209.	4/0-ML	.....	4/12-AR/R				
210.	24/24-AR/L	....	24/0-ML/L				
211.	24/24-AR/R	....	24/12-ML/R				
212.	4/0-ML	.....	4/0-AR				
213.	24/24-AR/L	....	24/24-ML/L				
*214.	12/0-AR	.....	24/24-AR/R				
215.	24/24-AR/L	....	12/24-ML/R				

Appendix IV

FIRING SCHEDULE FOR ABSOLUTE (ACTION) JUDGMENTS  
(Phase II)

- |                |                |                |
|----------------|----------------|----------------|
| 1. 12/24-I-MI  | 33. 24/12-L-AR | 65. 12/24-R-MI |
| 2. 24/12-L-MI  | 34. 4/0-MI     | 66. 12/24-R-AR |
| 3. 24/24-R-AR  | 35. 4/12-R-AR  | 67. 24/0-AR    |
| 4. 24/24-R-MI  | 36. 12/12-L-MI | 68. 4/0-MI     |
| 5. 4/0-MI      | 37. 4/12-L-AR  | 69. 24/0-MI    |
| 6. 4/24-L-MI   | 38. 12/0-MI    | 70. 24/12-L-MI |
| 7. 24/12-R-MI  | 39. 4/24-L-AR  | 71. 4/12-L-AR  |
| 8. 4/12-R-AR   | 40. 24/24-R-AR | 72. 24/12-R-AR |
| 9. 24/24-L-AR  | 41. 4/12-L-MI  | 73. 12/12-R-AR |
| 10. 12/12-R-AR | 42. 12/24-R-MI | 74. 4/12-L-MI  |
| 11. 24/24-L-MI | 43. 24/24-L-AR | 75. 12/0-MI    |
| 12. 12/0-MI    | 44. 24/12-R-MI | 76. 24/12-L-AR |
| 13. 4/12-L-MI  | 45. 12/12-R-MI | 77. 4/12-L-MI  |
| 14. 24/24-L-MI | 46. 4/12-R-AR  | 78. 4/12-R-MI  |
| 15. 24/0-AR    | 47. 4/12-R-MI  | 79. 24/12-R-AR |
| 16. 4/12-L-AR  | 48. 12/12-L-AR | 80. 24/12-R-MI |
| 17. 4/12-R-MI  | 49. 4/0-MI     | 81. 12/0-AR    |
| 18. 12/24-L-MI | 50. 24/0-MI    | 82. 12/0-MI    |
| 19. 24/12-R-AR | 51. 12/24-R-AR | 83. 12/12-L-AR |
| 20. 4/24-R-AR  | 52. 24/24-R-MI | 84. 24/0-MI    |
| 21. 24/12-L-MI | 53. 4/24-L-AR  | 85. 4/0-AR     |
| 22. 12/12-L-MI | 54. 4/24-R-MI  | 86. 12/12-R-AR |
| 23. 4/24-R-MI  | 55. 12/12-L-AR | 87. 24/0-AR    |
| 24. 12/12-R-MI | 56. 24/12-L-AR | 88. 12/12-R-MI |
| 25. 12/0-AR    | 57. 24/0-MI    | 89. 24/12-L-AR |
| 26. 12/24-L-AR | 58. 12/12-L-MI | 90. 12/0-AR    |
| 27. 4/0-AR     | 59. 4/12-L-MI  | 91. 12/12-L-MI |
| 28. 4/12-R-MI  | 60. 4/0-AR     | 92. 4/12-R-AR  |
| 29. 4/24-R-AR  | 61. 12/24-L-AR | 93. 24/0-AR    |
| 30. 12/0-AR    | 62. 12/12-R-MI | 94. 12/12-R-AR |
| 31. 4/24-L-MI  | 63. 24/12-R-MI | 95. 4/0-AR     |
| 32. 12/12-L-AR | 64. 4/12-L-AR  | 96. 24/12-R-AR |

---

KEY: First designation - Volume of fire.  
Second designation - Distance from observer.  
Third designation - Right, left or center aiming point.  
Fourth designation - Weapon type.

Appendix V

TABLES OF THE PERCENTAGE OF CASES IN WHICH AR FIRE WAS  
CONSIDERED MORE DANGEROUS THAN M1 FIRE FOR COMPARATIVE JUDGMENTS  
(Phase I)

TABLES OF THE PERCENTAGE OF CASES IN WHICH AR FIRE WAS CONSIDERED MORE DANGEROUS THAN M1 FIRE FOR COMPARATIVE JUDGMENTS<sup>1</sup>

COMBAT EXPERIENCED

M1 Rifle

RDS/Ft.	4/24	4/12	4/0	12/24	12/12	12/0	24/24	24/12	24/0
<u>AR</u> 4/24	68 60	60 30	37 60	10 30	10 30	3 30	37 30	13 30	7 30
4/12	77 30	58 60	40 30	30 30	23 30	20 30	47 30	13 30	3 30
4/0	93 30	83 30	63 60	73 30	47 30	12 60	67 30	27 30	10 30
12/24	93 30	57 30	42 60	58 60	30 30	20 30	73 15	11 45	13 30
12/12	90 30	73 30	67 60	87 30	58 60	37 30	50 60	33 30	17 30
12/0	87 30	87 30	83 30	90 30	60 30	45 60	70 30	63 30	33 30
24/24	83 60	53 45	43 30	80 60	43 30	33 60	60 60	44 45	10 30
24/12	93 30	77 30	60 30	90 30	80 30	57 30	63 30	58 60	27 30
24/0	90 30	87 30	93 60	83 30	83 30	70 30	87 30	87 30	43 60

1. The percentages are given in the upper portion of each cell. The number of cases on which the percentages are based are located in the lower portion of each cell.

Phase I (Continued)

NON-COMBAT EXPERIENCED

M1 Rifle

RDS/Ft. 4/24 4/12 4/0 12/24 12/12 12/0 24/24 24/12 24/0

4/24	42 60	50 30	53 60	13 30	3 30	13 30	10 30	3 30	7 30
4/12	37 30	50 60	40 30	23 30	10 30	13 30	20 30	7 30	0 30
4/0	50 30	43 30	28 60	23 30	3 30	13 60	17 30	10 30	7 30
12/24	97 30	90 30	85 60	60 60	70 30	57 30	33 15	22 45	23 30
12/12	93 30	87 30	88 60	67 30	67 60	37 30	37 60	33 30	13 30
12/0	97 30	77 30	93 30	77 30	67 30	67 60	20 30	43 30	23 30
24/24	78 60	71 45	93 30	90 60	83 30	77 60	72 60	67 45	30 30
24/12	87 30	90 30	97 30	80 30	87 30	83 30	77 30	65 60	70 30
24/0	97 30	90 30	98 60	93 30	87 30	87 30	40 30	60 30	55 60

AR

Appendix VI

SUMMARY TABLE: ANALYSIS OF VARIANCE OF ACTION JUDGMENTS VALUES  
(Phase II)



SOURCE	DF	SUM OF SQUARES	MEAN SQUARE	ERROR TERM*	F	SIG.
Experience	1	655.61	655.61	b	13.319	.005
Weapon	1	315.87	315.87	1	46.657	.005
Volume	2	5,236.85	2,618.425	2	194.245	.005
Dist.	2	218.39	109.195	3	11.768	.005
Weapon x Vol.	2	52.40	26.20	1	3.870	.025
Weapon x Dist.	2	.33	.165	2	.012	NS
Vol. x Dist.	4	78.62	19.655	3	2.118	NS
W x V x D	4	29.35	7.3375	7	.150	NS
Weapon x Exp.	1	.41	.41	1	.061	NS
Vol. x Exp.	2	60.71	30.355	2	2.252	NS
Dist. x Exp.	2	95.10	47.55	3	5.124	.01
W x V x Exp.	2	4.44	2.22	4	.021	NS
W x D x Exp.	2	1.03	.515	5	.046	NS
V x D x Exp.	4	32.73	8.1825	6	.161	NS
W x V x D x Exp.	4	6.14	1.535	7	.031	NS

ERROR SOURCE	DF	SUM OF SQUARES	MEAN SQUARE
Between	29	2,033.84	70.132
Within	510	9,012.94	17.672
b	28	1,378.23	49.223
1	28	189.55	6.770
2	56	754.88	13.480
3	56	519.62	9.279
4	56	6,005.32	107.238
5	56	6,240.58	111.439
6	112	5,675.25	50.672
7	112	5,485.70	48.979

\*The error term used to test the significance of main effect and interaction is specified by a number (or letter b) and located under the error source table.

# **EXHIBIT 6**

U60-247

**"DTIC USERS ONLY"**

PSYCHOLOGICAL EFFECT OF PATTERNS OF SMALL ARMS FIRE

RESEARCH STUDY REPORT VI

WILLARD S. VAUGHAN, JR.  
PEYTON G. WALKER

MILITARY PROJECT OFFICER  
CAPT. ROBERT F. ROSER

MILITARY FIELD SPECIALIST  
SP 3 RALPH A. POND

DATA ANALYSTS  
PFC SHELDON KRAMER  
PFC ALAN BROOKS

PSYCHOLOGICAL RESEARCH ASSOCIATES  
507 EIGHTEENTH STREET, SOUTH  
ARLINGTON 2, VIRGINIA

PRA REPORT 57-16

JULY 1957

Reproduced From  
Best Available Copy

U-2508

19981103 020

## PSYCHOLOGICAL EFFECT OF PATTERNS OF SMALL ARMS FIRE

### A. PURPOSE

THIS IS ONE OF A SERIES OF INVESTIGATIONS OF THE PSYCHOLOGICAL COMPONENT OF FIRE EFFECTIVENESS CONDUCTED AS PART OF THE PLATOON ORGANIZATION STUDIES RESEARCH PROGRAM.<sup>1</sup> PREVIOUS WORK IN THE AREA OF PSYCHOLOGICAL EFFECT HAS BEEN REPORTED IN RESEARCH STUDY REPORTS III AND IV. RESEARCH STUDY REPORT III OBTAINED WRITTEN RESPONSES FROM INFANTRYMEN CONCERNING THE COMPARATIVE DANGEROUSNESS OF OVERHEAD AR AND MI FIRE OF VARYING VOLUMES AND DISTANCES FROM THEM.<sup>2</sup> THIS STUDY ALSO OBTAINED INFORMATION CONCERNING THE TACTICAL ACTIONS INFANTRYMEN CONSIDERED APPROPRIATE WHEN TAKEN UNDER FIRE BY AUTOMATIC AND SEMI-AUTOMATIC WEAPONS DELIVERING VARIOUS VOLUMES OF FIRE AT DIFFERENT DISTANCES FROM THE TROOPS. RESEARCH STUDY REPORT IV OBTAINED QUESTIONNAIRE RESPONSES FROM COMBAT EXPERIENCED VETERANS CONCERNING THE RELATIVE DANGEROUSNESS OF WEAPONS THAT HAD BEEN FIRED AGAINST THEM IN COMBAT.<sup>3</sup>

THIS STUDY EXTENDS INVESTIGATION OF VARIABLES EXAMINED IN THE PREVIOUS WORK AND ATTEMPTS TO OBTAIN A MORE OPERATIONAL DEFINITION AND QUANTIFICATION OF THE WILLINGNESS OF MEN TO EXPOSE THEMSELVES TO THE FIRE OF SMALL ARMS WEAPONS.

### B. DEFINITION OF PSYCHOLOGICAL EFFECT

THE FIRE EFFECTIVENESS ASSESSMENT MODEL ASSUMES THAT EACH WEAPON SYSTEM, AS A FUNCTION OF ITS FIRE CHARACTERISTICS, HAS A MEASURABLE EFFECT UPON THE ACTIONS OF THE ENEMY; FIRE EFFECTIVENESS IS DEFINED AS THE DEGREE TO WHICH THE EFFECTIVENESS OF THE ENEMY'S RETURN FIRE IS REDUCED.<sup>4</sup> FIRE EFFECTIVENESS MAY BE DIVIDED INTO TWO COMPONENTS: PHYSICAL AND PSYCHOLOGICAL EFFECTS OF FIRE. THE PHYSICAL EFFECTS OF FIRE ARE TO KILL OR TO WOUND AND THUS REDUCE THE NUMBER OF ENEMY WHO ARE ABLE TO RETURN FIRE. THE PSYCHOLOGICAL EFFECT OF FIRE IS TO NEUTRALIZE THE ENEMY AND THUS REDUCE THE AMOUNT OF BATTLE TIME DURING WHICH THE ENEMY IS WILLING TO RETURN FIRE.

---

<sup>1</sup>THE PLATOON ORGANIZATION STUDIES RESEARCH PROGRAM WAS CONDUCTED BY PSYCHOLOGICAL RESEARCH ASSOCIATES FOR COMBAT OPERATIONS RESEARCH GROUP, CONTINENTAL ARMY COMMAND; AND RESEARCH OFFICE, EXPERIMENTATION CENTER OF THE COMBAT DEVELOPMENT EXPERIMENTATION CENTER. THE STUDY REPORTED HERE WAS CONDUCTED AT FT. BENNING, GEORGIA DURING OCTOBER 1956.

<sup>2</sup>PSYCHOLOGICAL EFFECTS OF SMALL ARMS FIRE ON COMBAT EXPERIENCED AND NON-EXPERIENCED INFANTRYMEN, RESEARCH STUDY REPORT III, PRA REPORT 57-9 JUNE 1957. 260-244

<sup>3</sup>PSYCHOLOGICAL EFFECTS OF PLATOON WEAPONS - A QUESTIONNAIRE STUDY, RESEARCH STUDY REPORT IV, PRA REPORT 57-10, JUNE 1957.

<sup>4</sup>THEORETICAL FRAMEWORK FOR THE STUDY OF PLATOON FIRE CAPABILITY, RESEARCH MEMORANDUM, PSYCHOLOGICAL RESEARCH ASSOCIATES, OCTOBER, 1956.

THE CONCEPT OF PSYCHOLOGICAL EFFECT IS VIEWED AS A REDUCTION IN THE EFFECTIVENESS OF ENEMY FIRE AS A RESULT OF FIRING TIME LOST BY THE ENEMY DUE TO HIS UNWILLINGNESS TO EXPOSE HIMSELF TO INCOMING FIRE. IN ORDER TO EVALUATE REDUCTION IN ENEMY EFFECTIVENESS IN TACTICALLY MEANINGFUL TERMS, IT IS NECESSARY TO FIRST QUANTIFY THE DAMAGE THE ENEMY COULD POTENTIALLY EFFECT, IN TERMS OF ACCUMULATED HIT PROBABILITIES, IF HE EXPOSED HIMSELF CONTINUOUSLY THROUGHOUT THE DURATION OF THE BATTLE. SECOND, THE DAMAGE THE ENEMY CAN ACTUALLY EFFECT, AS A FUNCTION OF THE DISTRIBUTION OF HIS EXPOSURE TIMES THROUGHOUT THE BATTLE, MUST BE QUANTIFIED IN TERMS OF THE HIT PROBABILITIES HE ACCUMULATES DURING THOSE DISCRETE EXPOSURES. THE DIFFERENCE BETWEEN THESE TWO PROBABILITY VALUES QUANTITATIVELY DEFINES PSYCHOLOGICAL EFFECT AND IS A TACTICALLY MEANINGFUL MEASURE.

AN EXPERIMENTAL APPROACH TO THE PROBLEM OF ASSESSING PSYCHOLOGICAL EFFECT DEFINED IN THIS MANNER REQUIRES TWO KINDS OF INFORMATION: (1) DIRECT MEASUREMENT OF THE DURATION OF EACH EXPOSURE OF THE ENEMY AS A RESULT OF INCOMING FIRE OF VARYING CHARACTERISTICS; AND, (2) AN EVALUATION OF THE EFFECTIVENESS OF VARYING DEGREES OF ENEMY EXPOSURE DURATIONS CORRESPONDING TO SPECIFIC WEAPONS FIRED BY THE ENEMY; THE FRIENDLY TARGETS; THE TERRAIN; VISIBILITY; ETC. CHARACTERISTIC OF THE BATTLE. WITH THESE TWO KINDS OF INFORMATION, ANY GIVEN EXPOSURE DURATION OF AN ENEMY ARMED WITH A WEAPON OF A GIVEN CLASS CAN BE ASSIGNED A VALUE IN TERMS OF THE HIT PROBABILITY HE ACCUMULATES DURING THAT INTERVAL. GIVEN THE DISTRIBUTION OF ENEMY EXPOSURE DURATIONS AND THE ENEMY'S EFFECTIVENESS VALUES ASSOCIATED WITH EACH EXPOSURE, THE ACTUAL PHYSICAL EFFECTIVENESS OF THE FIRER IS ASSESSED. THIS ACTUAL VALUE CAN THEN BE COMPARED WITH THE POTENTIAL VALUE THAT THE ENEMY FIRER COULD HAVE ACCUMULATED HAD HE BEEN CONTINUOUSLY EXPOSED DURING THE BATTLE. THE DIFFERENCE BETWEEN POTENTIAL AND ACTUAL HIT PROBABILITY VALUES REPRESENTS THE PSYCHOLOGICAL EFFECT OF FRIENDLY FIRE ON THAT ENEMY FIRER.

THIS REPORT AND RESEARCH STUDY REPORT II PROVIDE THE SORT OF COMPLEMENTARY INFORMATION REQUIRED FOR THE QUANTIFICATION OF PSYCHOLOGICAL EFFECT. RESEARCH STUDY REPORT II REPORTS HIT PROBABILITIES ACCUMULATED BY AR AND MI WEAPONS AS A FUNCTION OF FIRING TIME DURATION UNDER SPECIFIED BATTLEFIELD CONDITIONS.<sup>2</sup> THE STUDY DESCRIBED IN THIS REPORT DETERMINES EXPOSURE TIME DURATION DISTRIBUTIONS FOR INFANTRYMEN SUBJECTED TO INCOMING FIRE OF VARYING CHARACTERISTICS. THUS, THE CRITERION OF PSYCHOLOGICAL EFFECT USED IN THIS STUDY, AVERAGE DURATION OF EXPOSURE TIME, IS AN INTERMEDIATE ONE AND REQUIRES INTEGRATION WITH FIRE EFFECTIVENESS DATA OF THE SORT OBTAINED IN RESEARCH STUDY REPORT II. PROCEDURES FOR INTEGRATING THESE TWO KINDS OF DATA TO ARRIVE AT A TACTICALLY MEANINGFUL MEASURE OF PSYCHOLOGICAL EFFECT ARE ILLUSTRATED IN FIRE CAPABILITY OF INFANTRY WEAPONS.<sup>3</sup>

<sup>1</sup>THE TERMS FRIENDLY AND ENEMY ARE USED AS CONVENIENT FRAMES OF REFERENCE. BOTH ANTAGONISTS PRODUCE AND RECEIVE FIRE AND ITS EFFECTS.

<sup>2</sup>CUMULATIVE HIT PROBABILITY OF SMALL ARMS WEAPONS, RESEARCH STUDY REPORT II, PRA REPORT 57-8, JUNE 1957.

<sup>3</sup>FIRE CAPABILITY OF INFANTRY WEAPONS, PRA REPORT 57-6, JUNE 1957.

C. INDEPENDENT VARIABLES

THE WEAPONS INVESTIGATED IN TERMS OF THEIR PSYCHOLOGICAL EFFECT WERE THE M1 RIFLE, THE AUTOMATIC RIFLE AND THE LIGHT MACHINE GUN. THE FIRE CHARACTERISTICS OF THESE WEAPONS WHICH WERE SYSTEMATICALLY VARIED AND RELATED TO DEGREE OF TARGET EXPOSURE WERE AS FOLLOWS:

1. NUMBER OF ROUNDS PER BURST
2. NUMBER OF BURSTS PER MINUTE
3. DISTANCE OF FIRE FROM TARGET PERSONNEL
4. TEMPORAL AND SPATIAL DISTRIBUTION OF FIRE

D. PROCEDURES

1. RANGE LAYOUT

SIX PARTIALLY COVERED TWO-MAN PITS, APPROXIMATELY SEVEN YARDS APART AND REPRESENTING A DEFENSIVE SECTOR, WERE CONSTRUCTED 100 YARDS DOWNRANGE FROM A FIRING LINE. EACH PIT WAS SEPARATED INTO TWO COMPARTMENTS. EACH WAS FITTED WITH AN APPARATUS THAT ALLOWED THE SOLDIER IN THE COMPARTMENT TO MOVE HIS TARGET TO EITHER OF TWO POSITIONS: COVERED, OR EXPOSED TO FIRE FROM UPRANGE. THIS CONSTRUCTION PERMITTED TWO INFANTRYMEN TO MANIPULATE TARGETS AT EACH POSITION INDEPENDENTLY.

AN AIMING POINT WAS PLACED BEHIND EACH PIT 10 YARDS FURTHER DOWNRANGE AND DIRECTLY IN LINE WITH THE CENTER OF EACH PIT. THE EXPOSED POSITION OF EACH OF THE TARGET PAIRS WAS IN A DIRECT LINE BETWEEN THE FIRER'S AIMING POINT AND HIS POSITION UPRANGE. WHEN THE DEFENDER EXPOSED HIS TARGET, IT WAS DIRECTLY IN THE WEAPON'S LINE OF FIRE. WHEN THE DEFENDER COVERED HIS TARGET, IT WAS SHIFTED BEHIND A BARRICADE OF SANDBAGS.

EACH OF THE SIX DEFENDER PITS WAS OPPOSED BY A WEAPON POSITION UPRANGE DIRECTLY IN LINE WITH THE AIMING POINT CORRESPONDING TO THAT PIT. DEPENDING ON THE WEAPON CALLED FOR ON EACH FIRING TRIAL, A LIGHT MACHINE GUN, M1 OR AR WAS EMPLACED AT EACH OF THESE FIRING POSITIONS. THE FIRE OF THESE WEAPONS WAS CONTROLLED BY AN NCO FIRE CONTROLLER ASSIGNED TO EACH POSITION.

TWELVE NCO DATA RECORDERS WERE POSITIONED BEHIND THE FIRING LINE. EACH RECORDER OBSERVED ONE TARGET AND RECORDED FREQUENCY AND DURATION OF TARGET EXPOSURES DURING EACH TRIAL. THE SIX FIRE CONTROLLERS AND THE TWELVE DATA RECORDERS WERE ON A COMMON TELEPHONE NET WITH THE CONTROL OFFICER WHO COORDINATED THEIR ACTIVITIES. A DIAGRAM OF THE RANGE LAYOUT IS PRESENTED IN FIGURE 1.

2. TEST TROOPS

A. COMPOSITION AND EXPERIENCE. TEST TROOPS WERE COMBAT EXPERIENCED VETERANS FROM THE THIRD INFANTRY DIVISION, FORT BENNING, GEORGIA. ALL TEST TROOPS HAD BEEN IN ONE OR MORE COMBAT ZONES DURING THEIR ARMY CAREERS. THE AVERAGE COMBAT EXPERIENCE OF THE GROUP WAS 14

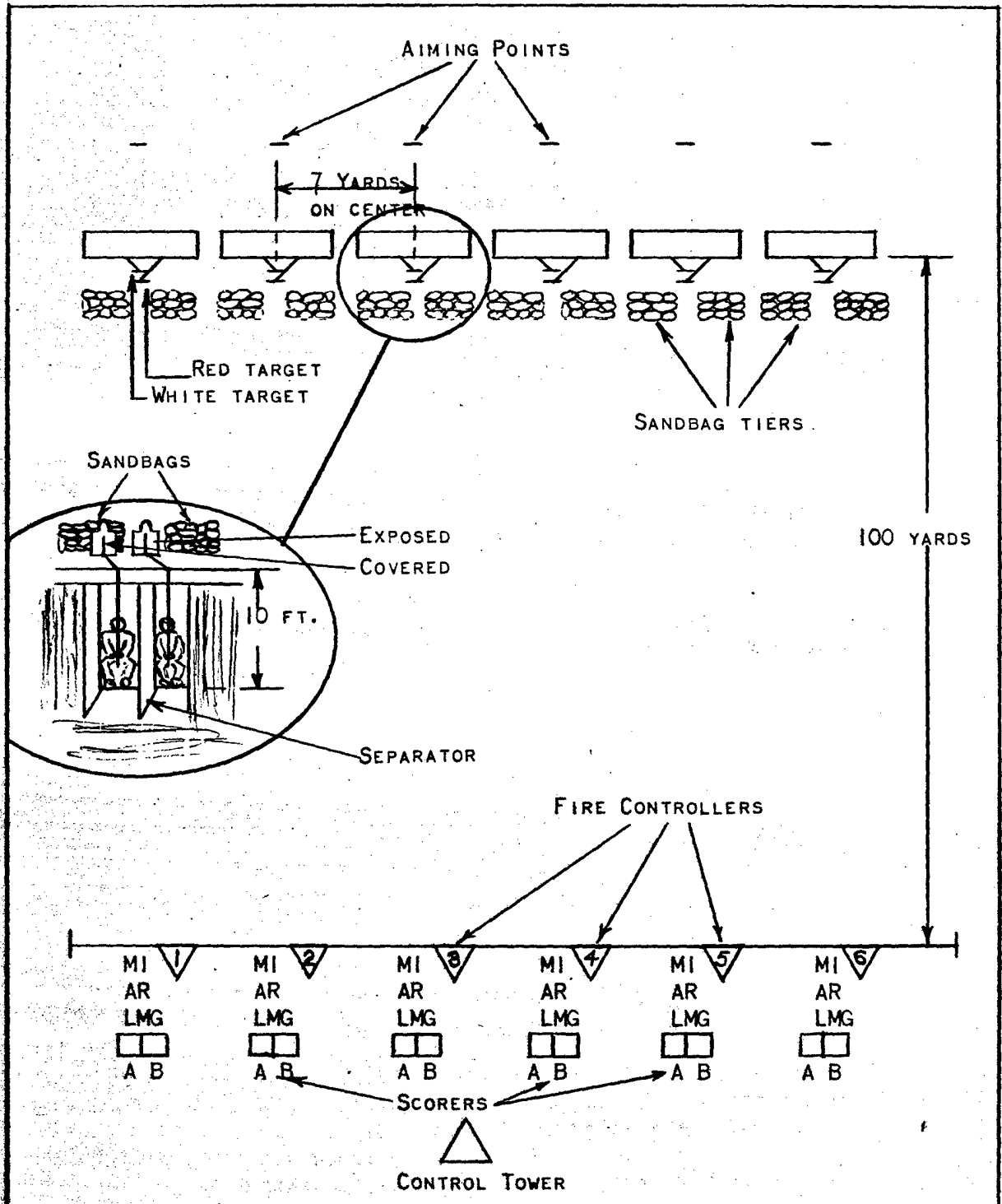

FIGURE I - RANGE LAYOUT  
PSYCHOLOGICAL EFFECT OF  
PATTERNS OF SMALL ARMS  
FIRE

MONTHS. 91% HAD PARTICIPATED IN AN ACTIVE DEFENSE AGAINST AN ENEMY ASSULT AND 67% HAD BEEN FIRED ON BY ENEMY EQUIVALENTS OF WEAPONS USED IN THIS STUDY. TWELVE MEN WERE ASSIGNED EACH DAY TO THE TWELVE TARGET LOCATIONS IN THE SIX PITS DOWN RANGE. TO MINIMIZE PRACTICE EFFECTS, TWELVE DIFFERENT MEN WERE TESTED ON EACH OF THE FIVE DAYS OF THE STUDY AND THEIR PIT ASSIGNMENTS WERE SHIFTED DURING THE COURSE OF EACH DAY'S FIRING TRIALS.

B. ORIENTATION AND TASK INSTRUCTIONS. EACH GROUP OF TROOPS WAS ORIENTED TO THE PURPOSE AND PROCEDURES OF THE STUDY PRIOR TO THEIR PARTICIPATION. THE GENERAL FIELD LAYOUT WAS DESCRIBED AND THEY WERE FAMILIARIZED WITH THE OPERATION OF THE TARGET APPARATUS. THE MAJOR POINTS STRESSED IN THE ORIENTATION WERE:

- (1) EACH TRIAL WILL BE OF THREE MINUTES DURATION.
- (2) THE FIRE FOR EACH TRIAL WILL BE RIGIDLY CONTROLLED AND UNAFFECTED BY TARGET PLAY DOWN RANGE.
- (3) FROM TRIAL TO TRIAL THE FIRE WILL BE FROM DIFFERENT WEAPONS, IN DIFFERENT VOLUMES, NUMBERS OF BURSTS AND DISTRIBUTION OF THE FIRE ACROSS THE SECTOR.
- (4) A FIELD TELEPHONE IN EACH PIT DOWNRANGE WILL RING TO SIGNAL THE BEGINNING AND END OF EACH FIRING TRIAL.
- (5) TARGETS WILL BE IN THE COVERED POSITION AT THE START OF EACH TRIAL.
- (6) DURING EACH TRIAL, EXPOSE AND COVER THE TARGET AS THOUGH IT REPRESENTED YOU IN A DEFENSE POSITION IN COMBAT.
- (7) EXPOSE THE TARGET WHEN YOU WOULD EXPOSE YOURSELF IN A COMBAT SITUATION. PUT THE TARGET IN COVER WHEN YOU FEEL THAT YOU WOULD TAKE COVER IN A COMBAT SITUATION.

### 3. EXPERIMENTAL CONDITIONS

#### A. DESCRIPTION OF THE VARIABLES STUDIED

##### (1) WEAPONS

THE PSYCHOLOGICAL EFFECT OF THE MI RIFLE, AR AND LMG WERE COMPARED.

##### (2) NUMBER OF ROUNDS PER BURST

WEAPONS WERE COMPARED FIRING THEIR CHARACTERISTIC VOLUME PER BURST AND FIRING EQUAL SIX-ROUND BURSTS. THE MI FIRED SINGLE ROUND BURSTS; THE AR FIRED TWO-ROUND BURSTS AND THE LMG FIRED SIX-ROUND BURSTS. THE VOLUME OF FIRE PER BURST OF THE MI AND AR WAS EQUATED TO THE LMG'S CHARACTERISTIC BURST VOLUME BY INCREASING THE NUMBER OF MI AND AR FIRERS.



(3) BURSTS PER MINUTE

WEAPONS WERE COMPARED WHEN FIRING 1, 4, 6 AND 12 BURSTS PER MINUTE. EACH FIRING TRIAL WAS OF THREE MINUTES DURATION.

(4) DISTANCE OF FIRE FROM TARGET PERSONNEL

THE SIX PITS WERE APPROXIMATELY SEVEN YARDS APART. EACH PATTERN OF OVERHEAD FIRE AT ANY SINGLE TARGET LOCATION PROVIDED COMPARATIVE PSYCHOLOGICAL EFFECT DATA AT SEVERAL DISTANCES. FIRE OVER EITHER OF THE END PITS FOR EXAMPLE, YIELDED TARGET EXPOSURE DATA AT DISTANCES 0, 7, 14, 21, 28 AND 35 YARDS FROM THE OVERHEAD FIRE.

(5) TEMPORAL DISTRIBUTION OF OVERHEAD FIRE

TO INVESTIGATE DIFFERENCES IN THE PSYCHOLOGICAL EFFECT OF THE MANNER IN WHICH OVERHEAD BURSTS OF FIRE WERE DELIVERED THROUGH TIME, A RANDOM DISTRIBUTION OF BURSTS WAS COMPARED WITH A SYSTEMATIC DISTRIBUTION FOR 4 AND 6 BURSTS PER MINUTE. BOTH SYSTEMATIC AND RANDOM DISTRIBUTIONS OF FIRE THROUGH TIME BEGAN WITH A BURST IN THE FIRST SECOND OF THE TRIAL. IN THE SYSTEMATIC CONDITION, REMAINING BURSTS WERE DISTRIBUTED IN REGULAR INTERVALS THEREAFTER; WHILE FOR THE RANDOM CONDITION, THE REMAINING BURSTS OCCURRED APERIODICALLY THROUGHOUT THE TRIAL.

(6) TEMPORAL AND SPATIAL DISTRIBUTION OF SECTOR FIRE

BURSTS OF 4, 6 AND 12 PER MINUTE WERE DISTRIBUTED ACROSS THE SIX PIT SECTOR. DIFFERENCES IN TECHNIQUES OF DISTRIBUTING FIRE ACROSS A SECTOR IN ACHIEVING PSYCHOLOGICAL EFFECT WERE INVESTIGATED. TRIALS WERE INCLUDED WHERE THE BURSTS WERE DELIVERED ACROSS THE SECTOR IN A SYSTEMATIC SPATIAL AND TEMPORAL PATTERN. THE DEGREE OF PSYCHOLOGICAL EFFECT ACHIEVED BY THIS TECHNIQUE WAS COMPARED WITH THE RESULTS FROM TRIALS WHERE THE BURSTS WERE DELIVERED ACROSS THE SECTOR IN A RANDOM SPATIAL AND TEMPORAL PATTERN. THE SPATIALLY SYSTEMATIC PATTERNS BEGAN WITH A BURST AT AN END PIT AND THE REMAINING BURSTS WERE FIRED IN SEQUENCE ACROSS THE SECTOR. TRIALS OF TWELVE BURSTS PER MINUTE DELIVERED THE FIRST SIX BURSTS IN A LEFT-TO-RIGHT PATTERN AND THE REMAINING SIX BURSTS, RIGHT-TO-LEFT. THE SPATIALLY RANDOM PATTERNS DELIVERED THE BURSTS ACROSS THE SECTOR IN AN ORDER DRAWN FROM A TABLE OF RANDOM NUMBERS.

B. METHOD OF PRESENTATION OF TRIALS

SYSTEMATIC VARIATIONS IN EACH OF THE MAJOR VARIABLES AND THEIR COMBINATIONS REQUIRED 230 FIRING TRIALS.<sup>1</sup> A FIRING SCHEDULE WAS PREPARED WHICH SPECIFIED FOR EACH TRIAL THE WEAPON, NUMBER OF BURSTS, VOLUME PER BURST, PIT OR ORDER OF PITS RECEIVING FIRE AND THE EXACT SECOND IN WHICH EACH BURST OF FIRE WAS TO OCCUR.<sup>2</sup> EACH FIRE CONTROLLER WAS GIVEN THIS SCHEDULE OF TRIALS AND WAS INSTRUCTED AND PRACTICED IN ITS USE. THE FIRE CONTROL OFFICER COORDINATED THE FIRE DELIVERY SYSTEM THROUGH TELEPHONE COMMUNICATION TO ALL FIRE CONTROLLERS. FOR EACH TRIAL, THE CONTROL OFFICER INDICATED THE TRIAL TO BE FIRED, ALERTED THE TEST TROOPS IN THE PITS AT THE BEGINNING OF EACH TRIAL BY A TELEPHONE RING SIGNAL, AND INITIATED A TAPED RECORDING OF A TIME COUNT FROM 0 TO 179 SECONDS CARRIED BY WIRE TO THE FIRE CONTROLLERS EQUIPPED WITH HEADSETS. THE FIRE CONTROLLERS INSTRUCTED THEIR FIRERS AS TO THE VOLUME OF FIRE PER BURST PRIOR TO EACH TRIAL AND INITIATED THE FIRE BY TAPPING THE FIRER AT THE APPROPRIATE SECOND(S) DURING THE TRIAL.

4. RESPONSE MEASURES

A. DATA RECORDED

(1) TARGET EXPOSURE - THOSE SECONDS DURING WHICH EACH TARGET WAS EXPOSED THROUGHOUT EACH TRIAL WERE RECORDED.

(2) TARGET HITS - WHEN A TARGET WAS EXPOSED IN THE SECOND DURING WHICH A BURST WAS FIRED AT THAT TARGET POSITION, A HIT ON THAT TARGET WAS RECORDED.

B. DATA COLLECTION PROCEDURES

A TRAINED OBSERVER RECORDED THE ACTIVITY OF EACH TARGET ON EACH TRIAL. EACH RECORDER WAS EQUIPPED WITH A TELEPHONE HEADSET THROUGH WHICH HE RECEIVED THE TIME COUNT FROM 0 TO 179 SECONDS AND A RECORDING FORM ON WHICH TO RECORD THE ACTIVITY OF HIS ASSIGNED TARGET. THE RECORDING FORM PERMITTED IDENTIFICATION OF THE FIRING TRIAL, THE PIT AND TARGET OBSERVED, AND ENABLED THE RECORDER TO ENTER THE EXACT SECOND OF THE TRIAL IN WHICH THE TARGET WAS EXPOSED AND THE SECOND IN WHICH IT WAS RETURNED TO THE COVERED POSITION FOR EACH EXPOSURE OF THE TARGET DURING A TRIAL.<sup>3</sup>

---

<sup>1</sup>THE ORIGINAL TEST DESIGN INCLUDED BURSTS OF 2 AND 3 PER MINUTE. THESE TRIALS WERE OMITTED DURING THE COURSE OF THE EXPERIMENT DUE TO TIME RESTRICTIONS.

<sup>2</sup>THE FIRING SCHEDULE IS PRESENTED IN APPENDIX I.

<sup>3</sup>THE RECORDING FORM IS PRESENTED IN APPENDIX I.

WHEN THE RECORDER'S ASSIGNED TARGET WAS EXPOSED DURING THE OCCURRENCE OF FIRE OVER THE POSITION, HE INDICATED ON THE RECORDING FORM THAT THE TARGET HAD BEEN HIT DURING THAT EXPOSURE.

#### 5. DATA PROCESSING AND ANALYSIS

A DATA PROCESSING FORM WAS PREPARED WHICH CONSOLIDATED FOR EACH FIRING TRIAL THE DISTRIBUTION OF FIRE AND THE CONDITION OF EACH TARGET FOR EACH SECOND OF THE 180 SECOND PERIOD.<sup>1</sup> FOR EACH SECOND OF THE TRIAL, ONE OF THE FOLLOWING ENTRIES WAS MADE ON THE PROCESSING FORM FOR EACH OF THE TWELVE TARGETS:

- A - ACTIVE: TARGET EXPOSED AND NOT RECEIVING FIRE
- N - NEUTRALIZED: TARGET COVERED AND NOT RECEIVING FIRE
- K - KILLED: TARGET EXPOSED AND RECEIVING FIRE
- C - COVERED: TARGET COVERED AND RECEIVING FIRE

THE DATA PROCESSING FORM SUMMARIZED THE FOLLOWING INFORMATION FOR EACH OF THE TWELVE TARGETS FOR EACH TRIAL:

- A. FREQUENCY OF EXPOSURES
- B. FREQUENCY OF NEUTRALIZATIONS
- C. DURATION OF EXPOSURE TIME
- D. DURATION OF NEUTRALIZED TIME
- E. FREQUENCY OF KILLS

THE SUMMARY DATA CONTAINED ON THE PROCESSING FORMS WERE REVIEWED. CRITERIA WERE ESTABLISHED FOR SELECTING THOSE TEST TROOPS WHO FOR ANY GIVEN TRIAL WERE NOT COOPERATING WITH THE STATED OBJECTIVES OF THE STUDY. CASES WERE ELIMINATED WHERE THE TARGET REMAINED COVERED MORE THAN 90% OF THE TRIAL TIME UNDER CONDITIONS OF LIGHT FIRE, OR WHERE THE TARGET REMAINED EXPOSED MORE THAN 90% OF THE TRIAL TIME UNDER CONDITIONS OF HEAVY FIRE. DATA FOR A FEW TRIALS WERE ELIMINATED ON THIS BASIS.<sup>2</sup>

TRIALS WERE GROUPED ACCORDING TO THE FIRING CONDITIONS WHICH THEY REPRESENTED.<sup>3</sup> FOR EACH CONDITION OF THE FIRE CHARACTERISTICS INVESTIGATED, TWO FREQUENCY DISTRIBUTIONS WERE GENERATED: EXPOSURE TIME DURATIONS AND NEUTRALIZED TIME DURATIONS. AS THE EXPOSURE TIME DURATION DISTRIBUTIONS MORE CLOSELY APPROXIMATED THE NORMAL FORM, THESE SCORES WERE ANALYZED<sup>4</sup> AND RELATED TO DIFFERENCES IN THE FIRE CHARACTERISTICS INVESTIGATED.

---

<sup>1</sup>THE DATA PROCESSING FORM IS PRESENTED IN APPENDIX I.

<sup>2</sup>THE OMITTED CASES ARE INDICATED ON THE PROCESSING FORMS.

<sup>3</sup>THE GROUPING OF TRIALS ACCORDING TO CONDITION OF FIRE IS PRESENTED IN APPENDIX I.

<sup>4</sup>SIGNIFICANCE OF DIFFERENCES WERE TESTED WITH THE T-TEST, SEE EDWARDS, A. L., EXPERIMENTAL DESIGN IN PSYCHOLOGICAL RESEARCH, RINEHART AND Co., NEW YORK: 1950 (CHAPTER 8).

E. RESULTS

THIS SECTION PRESENTS GRAPHS SUMMARIZING THE RESULTS OF THE STUDY. SIGNIFICANCE TESTS ARE REPORTED IN APPENDIX II AND SUMMARY DATA ARE REPORTED IN APPENDIX III.

1. WEAPONS

FIGURE 2 PRESENTS A GRAPH OF THE AVERAGE DURATION OF TARGET EXPOSURE ASSOCIATED WITH OVERHEAD FIRE FROM THE THREE WEAPONS STUDIED. THE WEAPONS FIRED EQUAL VOLUMES PER BURST AND EQUAL NUMBERS OF BURSTS PER TIME SO THAT ANY DIFFERENCES AMONG WEAPONS IN THEIR PSYCHOLOGICAL EFFECT WERE ATTRIBUTABLE TO CHARACTERISTICS INHERENT IN THE WEAPONS THEMSELVES. THERE WERE NO STATISTICALLY SIGNIFICANT DIFFERENCES AMONG THE WEAPONS UNDER THESE CONDITIONS. THIS RESULT DOES NOT SUPPORT THE FINDINGS OF THE RESEARCH STUDY REPORT III WHERE COMBAT EXPERIENCED INFANTRYMEN JUDGED AR FIRE TO BE MORE DANGEROUS THAN MI FIRE. THIS DISCREPANCY MAY BE A FUNCTION OF THE DIFFERENCES IN THE KIND OF RESPONSE USED IN THE TWO STUDIES TO DEFINE PSYCHOLOGICAL EFFECT. THE PREVIOUS STUDY USED VERBAL JUDGMENTS WHILE THE PRESENT STUDY USED TARGET EXPOSURE DURATIONS AS MEASURES OF PSYCHOLOGICAL EFFECT.

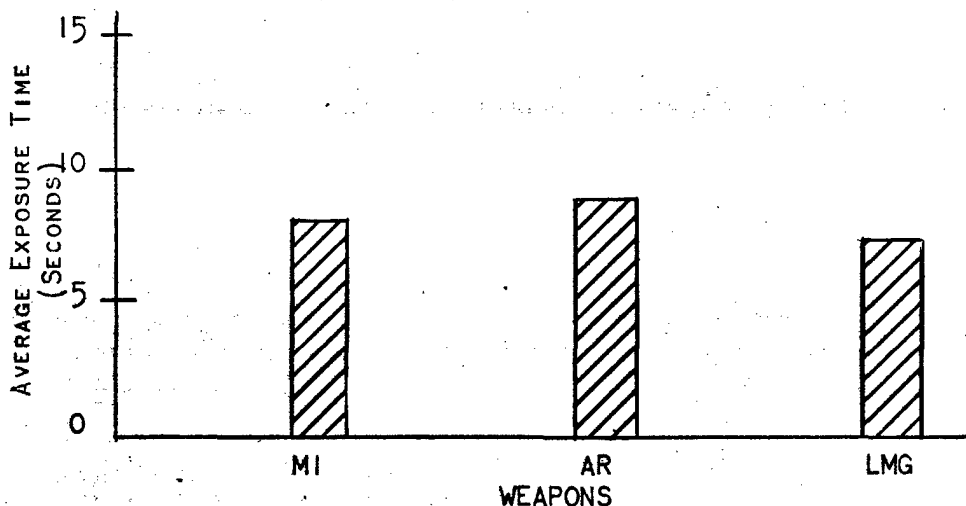

FIGURE 2 - AVERAGE EXPOSURE TIME AS A FUNCTION OF WEAPON TYPE WHEN WEAPONS FIRED EQUAL VOLUME BURSTS

2. NUMBER OF ROUNDS PER BURST

FIGURE 3 PRESENTS A GRAPH OF THE RELATIONSHIP BETWEEN AVERAGE DURATION OF TARGET EXPOSURE AND VARIATIONS IN NUMBER OF ROUNDS PER BURST OF OVERHEAD FIRE. THERE WERE NO SIGNIFICANT DIFFERENCES IN PSYCHOLOGICAL EFFECT AMONG 1, 2 AND 6 ROUNDS PER BURST SUMMED OVER ALL VARIATIONS IN NUMBER OF BURSTS PER TIME.

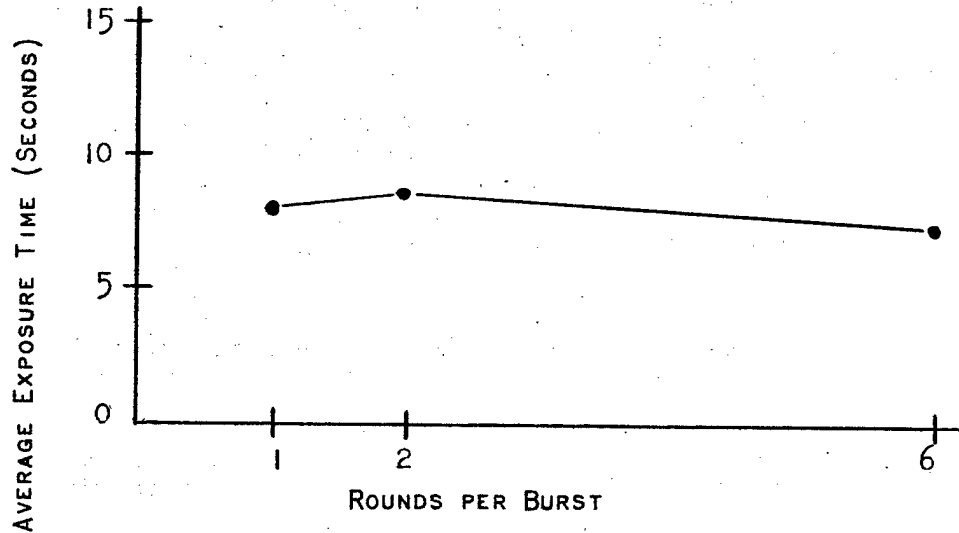

FIGURE 3 - AVERAGE EXPOSURE TIME AS A FUNCTION OF NUMBER OF ROUNDS PER BURST (DATA COMBINED OVER BURSTS AND COMBINED OVER WEAPONS AT 6 ROUNDS PER BURST.)

3. NUMBER OF BURSTS PER MINUTE

FIGURE 4 PRESENTS A GRAPH OF THE RELATIONSHIP BETWEEN THE AVERAGE DURATION OF TARGET EXPOSURE AND VARIATIONS IN NUMBER OF BURSTS PER MINUTE. THE AVERAGE EXPOSURE DURATION DECREASED AS THE NUMBER OF BURSTS OF OVER-HEAD FIRE INCREASED FROM 1 TO 12 BURSTS PER MINUTE.

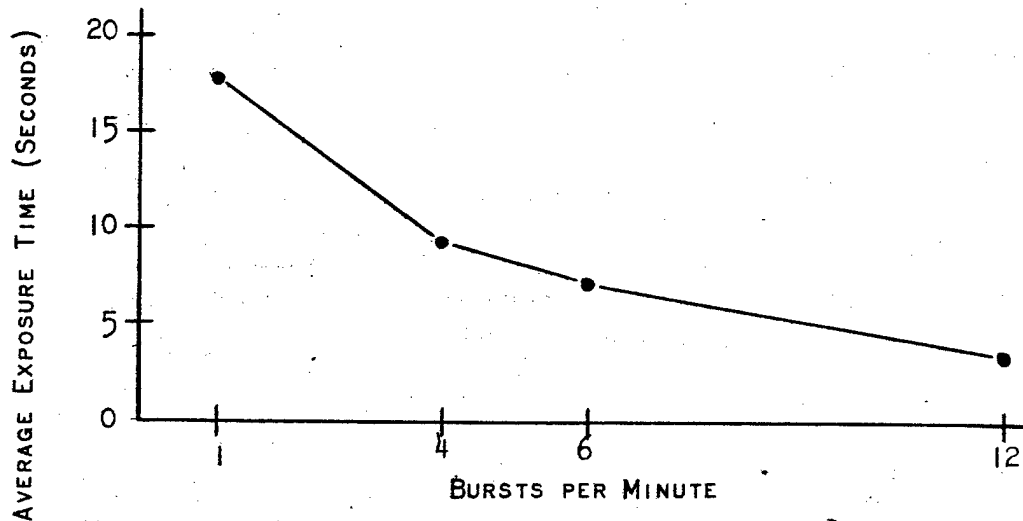

FIGURE 4 - AVERAGE EXPOSURE TIME AS A FUNCTION OF NUMBER OF BURSTS (DATA COMBINED OVER ALL WEAPONS AND VOLUMES PER BURST.)

#### 4. DISTANCE FROM OVERHEAD FIRE

FIGURE 5 PRESENTS A GRAPH OF THE RELATIONSHIP BETWEEN THE AVERAGE DURATION OF TARGET EXPOSURE AND LATERAL DISTANCE OF SUBJECTS FROM INCOMING FIRE. AS THE NUMBER OF CASES AT 28 AND 35 YARDS WAS SMALL, THE DATA FROM THESE DISTANCES WERE COMBINED, AVERAGED AND REPORTED IN FIGURE 5 AS A DISTANCE OF 31 1/2 YARDS. AVERAGE EXPOSURE TIME INCREASED WITH DISTANCE FROM THE OVERHEAD FIRE. THIS RESULT SUPPORTS THE FINDINGS OF RESEARCH STUDY REPORT III USING VERBAL JUDGMENTS AS THE CRITERION OF PSYCHOLOGICAL EFFECT.

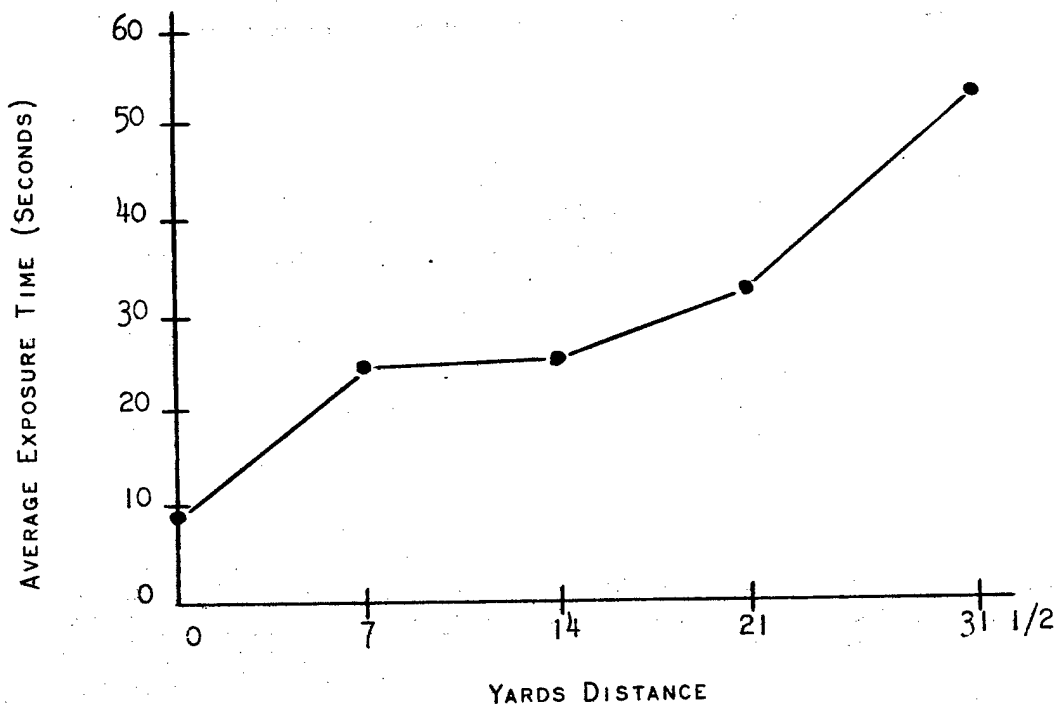

FIGURE 5 - AVERAGE EXPOSURE TIME AS A FUNCTION OF DISTANCE FROM OVERHEAD FIRE (DATA COMBINED FOR ALL WEAPONS AT 6 BURSTS PER MINUTE. WEAPONS FIRED UNEQUAL VOLUMES PER BURST.)

#### 5. TEMPORAL DISTRIBUTION OF OVERHEAD FIRE

FIGURE 6 PRESENTS A GRAPH OF THE RELATIONSHIPS BETWEEN THE AVERAGE DURATION OF TARGET EXPOSURE AND RANDOM VS. SYSTEMATIC TEMPORAL DELIVERY OF FIRE FOR 4 AND 6 BURSTS PER MINUTE. FOR 4 BURSTS PER MINUTE, TEMPORALLY RANDOM FIRE PRODUCED A SIGNIFICANT DECREASE IN AVERAGE EXPOSURE TIME AS COMPARED TO TEMPORALLY SYSTEMATIC DELIVERY. FOR 6 BURSTS PER MINUTE, HOWEVER, THE DIFFERENCE WAS NOT SIGNIFICANT.

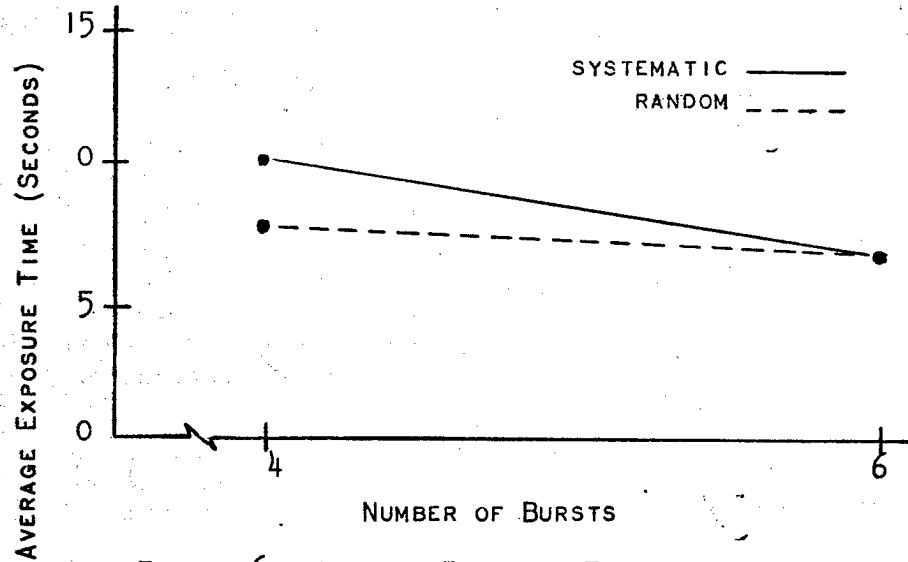

FIGURE 6 - AVERAGE EXPOSURE TIME AS A FUNCTION OF SYSTEMATIC AND RANDOM TEMPORAL DISTRIBUTION OF OVERHEAD FIRE (DATA COMBINED OVER WEAPONS FIRING UNEQUAL ROUNDS PER BURST.)

6. TEMPORAL AND SPATIAL DISTRIBUTION OF SECTOR FIRE

A. PSYCHOLOGICAL EFFECT

FIGURE 7 PRESENTS A GRAPH OF THE RELATIONSHIPS BETWEEN AVERAGE DURATION OF TARGET EXPOSURE AND RANDOM VS. SYSTEMATIC TEMPORAL AND SPATIAL DELIVERY OF BURSTS ACROSS THE SIX PIT SECTOR. THERE WERE NO DIFFERENCES IN AVERAGE TARGET EXPOSURE DURATION FOR TEMPORALLY AND SPATIALLY RANDOM FIRE AS OPPOSED TO TEMPORALLY AND SPATIALLY SYSTEMATIC FIRE.

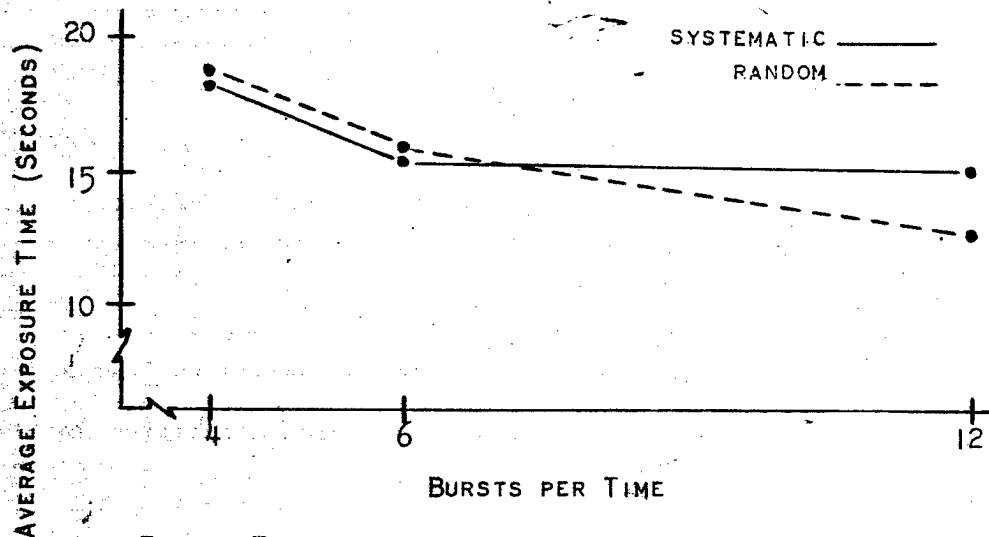

FIGURE 7 - AVERAGE EXPOSURE TIME AS A FUNCTION OF RANDOM VS. SYSTEMATIC TEMPORAL AND SPATIAL DISTRIBUTION OF FIRE (DATA COMBINED OVER WEAPONS FIRING UNEQUAL ROUNDS PER BURST,)

B. KILL EFFECT

FIGURE 8 PRESENTS A GRAPH OF THE RELATIONSHIP BETWEEN DIFFERENCES IN DISTRIBUTION OF SECTOR FIRE AND THE PERCENT OF TARGET HITS RELATIVE TO THE TOTAL NUMBER OF POTENTIAL TARGETS PER BURST FOR 4, 6, AND 12 BURSTS PER MINUTE. THE PROPORTION OF TARGET KILLS ASSOCIATED WITH THE RANDOM CONDITION OF FIRE DELIVERY IS CONSISTENTLY HIGHER THAN THAT ASSOCIATED WITH THE SYSTEMATICALLY DELIVERED FIRE. WHILE THERE SEEMS TO BE NO DIFFERENCES IN AVERAGE EXPOSURE DURATION BETWEEN THE TWO CONDITIONS OF FIRE DISTRIBUTION, THE FREQUENCY OF HITS IS SIGNIFICANTLY GREATER WHEN THE FIRE IS DISTRIBUTED RANDOMLY AGAINST AN INTELLIGENT "ENEMY".

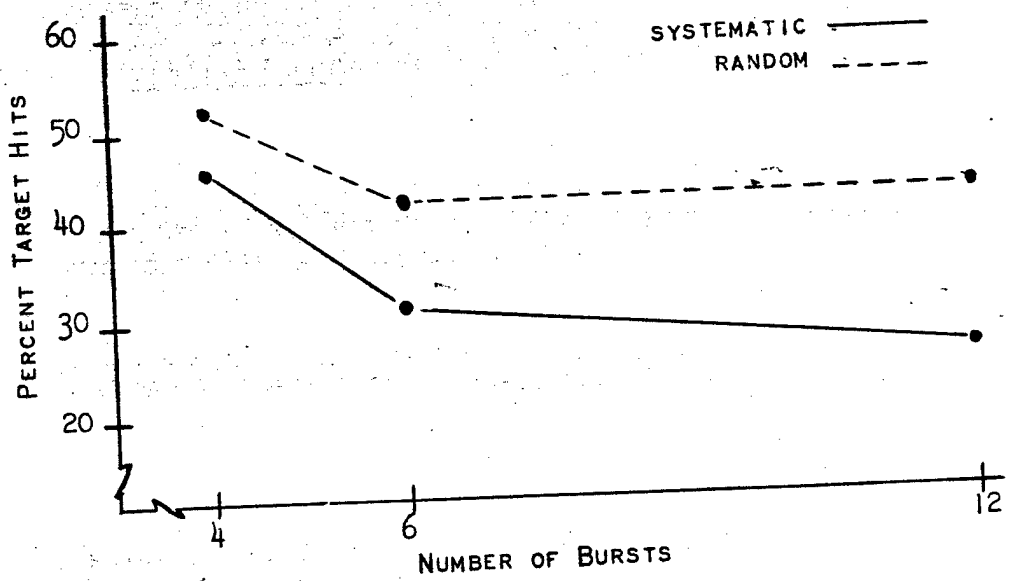

FIGURE 8 - PROPORTION OF TARGET HITS PER BURST FOR SECTOR FIRE OF 4, 6 AND 12 BURSTS PER MINUTE AS A FUNCTION OF RANDOM AND SYSTEMATIC DISTRIBUTION OF FIRE (DATA COMBINED OVER WEAPONS AND ROUNDS PER BURST.)

F. CONCLUSIONS

1. DIFFERENCES AMONG THE MI, AR, AND LMG RESULTED IN NO DIFFERENTIAL EFFECT ON AVERAGE DURATION OF TARGET EXPOSURE WHEN FIRING EQUAL NUMBERS OF BURSTS AND ROUNDS PER BURST.
2. DIFFERENCES IN NUMBER OF ROUNDS PER BURST OF FIRE RESULTED IN NO DIFFERENTIAL EFFECT ON AVERAGE DURATION OF TARGET EXPOSURE.
3. AVERAGE DURATION OF TARGET EXPOSURE DECREASED AS THE NUMBER OF BURSTS PER TIME INCREASED.



4. AVERAGE DURATION OF TARGET EXPOSURE INCREASED AS DISTANCE FROM OVERHEAD FIRE INCREASED.

5. A TEMPORALLY RANDOM DISTRIBUTION OF 4 BURSTS PER MINUTE OF OVERHEAD FIRE RESULTED IN A SHORTER AVERAGE DURATION OF TARGET EXPOSURE THAN A TEMPORALLY SYSTEMATIC DELIVERY. THERE WERE NO DIFFERENCES BETWEEN THE TWO TYPES OF FIRE DELIVERY FOR 6 BURSTS PER MINUTE.

6. RANDOM TEMPORAL AND SPATIAL DELIVERY OF FIRE ACROSS THE SIX PIT SECTOR DID NOT EFFECT A DIFFERENCE IN AVERAGE DURATION OF TARGET EXPOSURE DURATION AS COMPARED WITH A SYSTEMATIC TEMPORAL AND SPATIAL DISTRIBUTION. ON THE OTHER HAND, THE RELATIVE FREQUENCY OF TARGET HITS WAS SIGNIFICANTLY AFFECTED BY DIFFERENCES IN TEMPORAL AND SPATIAL DELIVERY. THE RANDOM SPATIAL AND TEMPORAL DISTRIBUTION RESULTED IN SIGNIFICANTLY MORE TARGET HITS AS COMPARED TO THE SYSTEMATIC DISTRIBUTION.

G. IMPLICATIONS SUPPORTING CURRENT TRAINING DOCTRINE

RESULTS OF THIS STUDY SHOULD BE CROSS-VALIDATED; ESPECIALLY THOSE THAT HAVE TO DO WITH THE PSYCHOLOGICAL EFFECT OF INDIVIDUAL BURSTS OF MI AS COMPARED WITH BURSTS FROM AUTOMATIC WEAPONS. THESE RESULTS ARE NOT CONSISTANT WITH THOSE FOUND IN RESEARCH STUDY REPORT III. HOWEVER, IN GENERAL, CONSISTENCY OF FINDINGS OF THE TWO STUDIES HAVE THE FOLLOWING TACTICAL IMPLICATIONS WHICH REINFORCE CURRENT TRAINING DOCTRINE.

A. H. 27

1. MAXIMUM PSYCHOLOGICAL EFFECT CAN BE ACHIEVED AT A MINIMAL AMMUNITION EXPENSE BY FIRING REPEATED SHORT BURSTS. THUS, WEAPONS SHOULD BE CAPABLE OF FIRING SUCH BURSTS AND TRAINING DOCTRINE SHOULD EMPHASIZE IT

2. A RANDOM PATTERN OF FIRE PRODUCES AS MUCH PSYCHOLOGICAL EFFECT AS A SYSTEMATIC PATTERN AND KILLS MORE TARGETS. FIRERS SHOULD BE TRAINED NOT TO MAINTAIN A SYSTEMATIC PATTERN OF FIRE BUT TO PLACE FIRE ON TARGET AREAS IN A RANDOM MANNER. BY FIRING IN THIS MANNER, THE ENEMY CANNOT DIAGNOSE A SYSTEMATIC PATTERN OF FIRE AND USE IT TO HIS ADVANTAGE.

H. GENERAL IMPLICATIONS

RESULTS OF THE STUDY REPORTED HERE AND THOSE REPORTED IN RESEARCH STUDY REPORT II GIVE PROMISE OF PROVIDING QUANTITATIVE SOLUTION TO PROBLEMS OF WEAPON SELECTION AND DETERMINATION OF TRAINING DOCTRINE FOR THE PLATOON. FROM THIS STUDY, WE CAN DETERMINE CHARACTERISTICS OF FIRE THAT KEEP A SOLDIER DOWN FOR GIVEN PERIODS OF TIME - OR, STATED IN OPPOSITE TERMS, THAT INFLUENCE HIM TO STAY UP TO RETURN FIRE ONLY FOR GIVEN INTERVALS OF TIME.

FROM RESEARCH STUDY REPORT II, WE CAN DETERMINE THE SOLDIER'S HIT EFFECTIVENESS DURING TIME INTERVALS OF VARIOUS LENGTHS WHEN HE IS EXPOSED AND FIRING. THESE TWO SETS OF DATA CAN BE BROUGHT TOGETHER AS ILLUSTRATED IN FIRE CAPABILITY OF INFANTRY WEAPONS. IT IS THEN POSSIBLE TO DETERMINE WHAT WEAPONS, TECHNIQUES OF FIRING AND DISTANCE OF FIRE FROM ENEMY PERSONNEL ARE REQUIRED TO NEUTRALIZE.

ADMITTEDLY THE "TRUE" VALUES OF PSYCHOLOGICAL EFFECT ARE NOT KNOWN. HOWEVER, IT CAN BE CLAIMED THAT CONSISTENCY OF RESULTS IN THIS AND PRIOR STUDIES ON PSYCHOLOGICAL EFFECT LENDS INFERENTIAL VALIDITY TO REPORTED RESULTS. IT IS, OF COURSE, PROBABLE THAT THE ABSOLUTE AMOUNT AND TYPE OF FIRE REQUIRED TO NEUTRALIZE MAY DIFFER BETWEEN THESE STUDY FINDINGS AND THE AMOUNT AND TYPE OF FIRE REQUIRED IN COMBAT. HOWEVER, IT IS LIKELY THAT THE RELATIONSHIP BETWEEN RELATIVE AMOUNTS AND TYPES OF FIRE DELIVERED AND THE ENEMY'S DISPOSITION TO TAKE COVER WILL REMAIN GENERALLY IN LINE WITH FINDINGS REPORTED HERE. MORE IMPORTANTLY, THIS STUDY PROVIDES METHODS AND BASIC DATA FROM WHICH FURTHER RESEARCH IN THE AREA CAN BE GENERATED TO REFINE AND ADJUST THESE RESULTS.

THE CONCEPT OF REDUCTION IN ENEMY EFFECTIVENESS AS THE MEASURE OF FRIENDLY FIRE EFFECTIVENESS, AND THE DEVELOPMENT OF THE METHODOLOGY FOR ASSESSING THE CONTRIBUTION OF PSYCHOLOGICAL AND PHYSICAL EFFECTS TO THIS REDUCTION OF ENEMY EFFECTIVENESS HAS IMPORTANT IMPLICATIONS FOR THE DEVELOPMENT OF A COMPREHENSIVE MILITARY SCIENCE. ONCE THE FIRE PARAMETERS WHICH MAKE MAJOR CONTRIBUTIONS TO PHYSICAL AND PSYCHOLOGICAL EFFECTS HAVE BEEN IDENTIFIED AND QUANTIFIED UNDER A SUFFICIENT VARIETY OF BATTLEFIELD CONDITIONS, THE NECESSARY AMOUNTS AND TYPES OF FIRE CAN BE ADJUSTED BY THE FIELD COMMANDER TO ACHIEVE REQUIRED EFFECTIVENESS. DEPENDING UPON THE PARTICULAR REQUIREMENTS OF THE COMBAT ACTION, THE COMMANDER CAN UTILIZE WEAPONS AND SPECIFY THEIR FIRE TO ACHIEVE MAXIMUM PSYCHOLOGICAL EFFECT, MAXIMUM KILLS, OR HE CAN CHOOSE TO FIX THE FIRE CONDITIONS TO ACHIEVE AN OPTIMIZATION OF KILLING AND NEUTRALIZING EFFECTS.

TO THE EXTENT THAT THE RELATIONSHIPS BETWEEN FRIENDLY FIRE INPUTS AND ENEMY FIRE OUTPUTS ARE REFINED, THE FIELD COMMANDER WITH INFORMATION REGARDING THE ENEMY'S STRENGTH CAN SELECT THE SPECIFIC WEAPON INPUTS REQUIRED TO HOLD THE ENEMY OUTPUT TO A MINIMUM OR REDUCE IT THROUGH TIME TO A TACTICALLY DISASTEROUS LEVEL.

# **EXHIBIT 7**

**UNCLASSIFIED** #18154



**AD NUMBER**

**AD-488 336**

**NEW LIMITATION CHANGE**

**TO**

**DISTRIBUTION STATEMENT - A**

Approved for Public Release; Distribution Unlimited.

**Limitation Code: 1**

**FROM**

**DISTRIBUTION STATEMENT - NONE**

No Prior DoD Distribution Security Control Statement Assigned.

**Limitation Code: NONE**

**AUTHORITY**

U.S. Army Operational Test and Evaluation Command, CSTE-IMZ, Alexandria, VA, via memo., dtd June 3, 1996 signed by Mr. Gary C. Miller, DCS/Info. Management.

**THIS PAGE IS UNCLASSIFIED**

FOR OFFICIAL USE ONLY

①  
PK

488336

AD No. \_\_\_\_\_  
DDC FILE COPY

# SMALL ARMS WEAPON SYSTEMS (SAWS).

PART ONE: MAIN TEXT.

SOURCE DATA  
SMALL ARMS  
WEAPONS SYSTEM  
STUDY  
MAY 96

- ⑪ 10 May 66
- ⑫ 272 p.

SEP 12 1966  
Abr



U. S. ARMY COMBAT DEVELOPMENTS COMMAND  
EXPERIMENTATION COMMAND FORT ORD, CALIFORNIA

Reproduced From  
Best Available Copy

PROTECTIVE MARKING OF THIS DOCUMENT WILL  
BE TERMINATED 3 YEARS AFTER ORIGINATION.

FOR OFFICIAL USE ONLY

COPY NO. \_\_\_\_\_

1037210

19991122107

THIS REPORT IS FOR INFORMATION ONLY. ACTION COPIES ARE SUBMITTED DIRECTLY TO COMMANDING GENERAL, US ARMY COMBAT DEVELOPMENTS COMMAND. THE VIEWS EXPRESSED IN THIS REPORT ARE THOSE OF THE COMMANDING GENERAL, US ARMY COMBAT DEVELOPMENTS COMMAND EXPERIMENTATION COMMAND AND ARE NOT NECESSARILY THOSE OF THE US ARMY COMBAT DEVELOPMENTS COMMAND OR THE DEPARTMENT OF THE ARMY.

**SMALL ARMS WEAPON SYSTEM (SAWS)  
FIELD EXPERIMENT**

**In Two Parts**

**PART ONE: MAIN TEXT**

**FOR OFFICIAL USE ONLY**

**HEADQUARTERS  
UNITED STATES ARMY COMBAT DEVELOPMENTS COMMAND  
EXPERIMENTATION COMMAND  
Fort Ord, California**

**SMALL ARMS WEAPON SYSTEMS (SAWS)  
FIELD EXPERIMENT**

~~(GDCEC 65-4)~~

10 May 1966

**APPROVED:**

*L. G. Cagwin*

**L. G. CAGWIN  
Major General, United States Army  
Commanding**

**FOR OFFICIAL USE ONLY**



**BLANK PAGE**

#### AUTHORITY

1. Letter, CDCRE-E, HQ, USACDC, 23 February 1965, subject: US Army Combat Developments Command Experimentation Center Experiment - Small Arms Weapon Systems (SAWS)
2. Directive, US Army Combat Developments Command, 5 March 1965, subject: Army Small Arms Weapon Systems Program (SAWS)
3. Outline Plan USACDCEC Experiment 65-4, Small Arms Weapon Systems (SAWS) (U), July 1965
4. Letter, CDCRE-E, HQ, USACDC, 7 September 1965, subject: Outline Plan, Small Arms Weapon Systems (SAWS) Experiment

#### CORRELATION

The Small Arms Weapon Systems (SAWS) Experiment is identified as USACDC Action Control No. M3523 and supports the following:

- |                         |   |
|-------------------------|---|
| a. Army Concept Program | Army 75   |
| b. Army Tasks           | 1: High Intensity Conflict<br>2: Mid Intensity Conflict<br>3: Low Intensity Conflict Type I<br>4: Low Intensity Conflict Type II<br>7: Complementing Allied Landpower |
| c. Phase                | Evaluation  |
| d. Functions            | Firepower   |

#### CONTRACTUAL AGREEMENT

##### Scientific Support

Research Office, USACDCEC, Stanford Research Institute,  
Contract No. DA 04-200-AMC-1104(X).

#### **ACKNOWLEDGMENT**

**The United States Army Combat Developments  
Command Experimentation Command wishes to  
express appreciation to the United States Army  
Training Center, Infantry, Fort Ord, California,  
for its outstanding cooperation and support during  
the conduct of the SAWS experiment.**

CONTENTS

Part One: Main Text

ABSTRACT . . . . . xvi

SECTION I INTRODUCTION

A. Purpose . . . . . 1-1  
B. Scope . . . . . 1-1  
C. Objectives . . . . . 1-2  
D. Phasing and Location . . . . . 1-3  
E. Concept . . . . . 1-3  
F. Conduct of the Experiment . . . . . 1-4

SECTION II EXPERIMENTAL DESIGN

A. General Characteristics of the Design . . . . . 2-1  
B. Experimentation Materiel . . . . . 2-1  
    1. Weapons and Ammunition . . . . . 2-2  
    2. Organization of Materiel for Experimentation . . . . . 2-8  
C. Instrumentation . . . . . 2-8  
D. Experiment Personnel . . . . . 2-15  
    1. Source of Support Personnel . . . . . 2-15  
    2. Source of Experimentation Subjects . . . . . 2-15  
    3. Organization of Experimentation Subjects . . . . . 2-15  
    4. Training Program for Experimentation Subjects . . . . . 2-16  
E. Experimentation Procedures . . . . . 2-22  
    1. Uniform Operational Policies - General . . . . . 2-22  
    2. Control and Balance of Weapon Mix Structure and Equipment . . . . . 2-22  
    3. Modes of Fire . . . . . 2-23  
    4. Control for Differences in Firer Location and Opportunity . . . . . 2-23  
    5. Control of Squad Leader Variability . . . . . 2-23  
    6. Control for Effects of Learning . . . . . 2-23  
    7. Data Collection Procedures - Primary Measures . . . . . 2-24  
    8. Administrative Procedures . . . . . 2-24

CONTENTS (Continued)

F. Experimentation Tactical Situations . . . . . 2-25

1. Situation 1: Rifle Squad in Line Assault . . . . . 2-27

2. Situation 2: Rifle Squad as a Base of Fire Supporting the Assault . . . . . 2-27

3. Situation 3: Machinegun Squad in Fire Support of the Assault . . . . . 2-30

4. Situation 4: Rifle Squad in Approach to Contact . . . . . 2-30

5. Situation 5: Rifle Squad as a Base of Fire Supporting the Advance . . . . . 2-30

6. Situation 6: Machinegun Squad in Fire Support of Advance . . . . . 2-35

7. Situation 7: Rifle Squad in Defense Against Attack . . . . . 2-35

8. Situation 8: Rifle Squad in Night Defense Against Attack . . . . . 2-38

9. Situation 9: Machinegun Squad in Defense Against Attack . . . . . 2-38

10. Summary of Tactical Situations . . . . . 2-38

G. Effectiveness Measures (Evaluation Criteria) . . . . . 2-41

1. Effectiveness Concept . . . . . 2-41

2. Measures of Effectiveness . . . . . 2-42

3. Effectiveness Qualities - Combat Effectiveness Components . . . . . 2-48

SECTION III METHODOLOGY FOR THE PRESENTATION OF RESULTS

A. Organization of Results . . . . . 3-1

B. Data Presentation Format . . . . . 3-1

C. Explanation and Description of Data . . . . . 3-3

1. Performance and Statistical Probability Measures . . . . . 3-3

2. Combined Use of Descriptive Performance Measures and Statistical Probability Data . . . . . 3-6

3. Standard Scores . . . . . 3-7

4. SAWS Target Effects and Overall Effectiveness Scores . . . . . 3-10

5. Expected Scores . . . . . 3-11

6. Graphical Presentation of Measures as a Function of Time and Range . . . . . 3-12

7. Histogram (Bar Graph) Presentation of Near Misses as a Function of Target Location . . . . . 3-18

D. Analysis and Derivation of Conclusions . . . . . 3-20

CONTENTS (Continued)

SECTION IV TRAINING RESULTS

- A. Rifle . . . . . 4-1
  - 1. Disassembly and Assembly . . . . . 4-1
  - 2. Trainfire Record Range . . . . . 4-3
  - 3. 25-meter Rifle in Automatic Mode . . . . . 4-7
  - 4. 200-meter Rifle in the Automatic Mode . . . . . 4-7
- B. Automatic Rifle . . . . . 4-9
  - 1. Disassembly and Assembly . . . . . 4-9
  - 2. Interim Transition Record . . . . . 4-9
  - 3. 25-meter Automatic Rifle . . . . . 4-9
- C. Machinegun . . . . . 4-9
  - 1. Assembly and Disassembly . . . . . 4-9
  - 2. Record Firing, Tables II, III, and IV . . . . . 4-9
- D. Contamination of Training Scores by Weather . . . . . 4-17

SECTION V MATERIEL RELIABILITY RESULTS

- A. Purpose of Reliability Data . . . . . 5-1
- B. Data Collected and Observations . . . . . 5-2
- C. Reliability Results and Findings . . . . . 5-2
  - 1. Major Causes of Malfunctions in US 7.62mm Weapons . . . . . 5-7
  - 2. Major Causes of Malfunctions in 5.56mm Weapons . . . . . 5-7
- D. Effect of Malfunctions on Experimentation . . . . . 5-12

SECTION VI SQUAD WEAPON MIX FIRE EFFECTIVENESS RESULTS

- A. Rifle Squad Experiment . . . . . 6-1
  - 1. Situation 1: Rifle Squad in Line Assault . . . . . 6-1
  - 2. Situation 2: Rifle Squad as Base of Fire Supporting the Assault . . . . . 6-20
  - 3. Situation 4: Rifle Squad in Approach to Contact . . . . . 6-37
  - 4. Situation 5: Rifle Squad as a Base of Fire Supporting the Advance . . . . . 6-48
  - 5. Situation 7: Rifle Squad in Defense Against Attack . . . . . 6-69

CONTENTS (Continued)

6.	Situation 8: Rifle Squad in Night Defense Against Attack . . . . .	6-78
7.	Combined Results - Rifle Squad Experiment . . . . .	6-89
B.	Supplementary Rifle Squad Experiment . . . . .	6-93
1.	MC Versus MB . . . . .	6-93
2.	CX Versus CY . . . . .	6-93
3.	MC Versus CY . . . . .	6-96
C.	Machinegun Squad Experiment . . . . .	6-99
1.	Situation 3: Machinegun Squad in Fire Support of the Assault . . . . .	6-99
2.	Situation 5A: Machinegun Squad as a Base of Fire Supporting the Advance (375 to 560 meters) . . . . .	6-99
3.	Situation 6: Machinegun Squad in Fire Support of the Advance (446 to 753 meters) . . . . .	6-100
4.	Situation 9: Machinegun Squad in Defense Against Attack . . . . .	6-101
5.	Discussion . . . . .	6-101
 SECTION VII DUPLEX AMMUNITION EXPERIMENT		
A.	Rifle Duplex Ammunition Experiment . . . . .	7-1
B.	Automatic Rifle Duplex Ammunition Experiment . . . . .	7-18
C.	M60 Machinegun Duplex Ammunition Experiment . . . . .	7-18
 SECTION VIII LETHALITY DATA IMPLICATIONS . . . . .		
		8-1
 SECTION IX CONCLUSIONS . . . . .		
		9-1

Part Two: Annexes

ANNEXES

- A Squad Organization and Operational Policies
- B Ranges, Instrumentation, and Data Collection
- C Materiel
- D Correlation Analysis
- E Small Arms Lethality

CONTENTS (Continued)

F	Bibliography	
G	Distribution	
<b>Figures</b>		
2-1	US 7.62mm Weapons . . . . .	2-3
2-2	Colt 5.56mm Weapons . . . . .	2-4
2-3	Stoner 63 5.56mm Weapons . . . . .	2-5
2-4	Soviet-type 7.62mm Weapons . . . . .	2-6
2-5	Types of Ammunition . . . . .	2-7
2-6	Standing, Kneeling, and Head and Shoulder Targets	2-13
2-7	Acoustic Near Miss Sensor . . . . .	2-14
2-8	Panel Near Miss Sensor . . . . .	2-14
2-9	Situation 1, Range A . . . . .	2-28
2-10	Situation 2, Range A . . . . .	2-29
2-11	Situation 3, Range A . . . . .	2-31
2-12	Situation 4, Approach to Contact, Range B . . . . .	2-32
2-13	Situation 4, Range B . . . . .	2-33
2-14	Situation 5, Range B . . . . .	2-34
2-15	Situation 6, Range B . . . . .	2-36
2-16	Situation 7, Range C . . . . .	2-37
2-17	Situation 8, Range C . . . . .	2-39
2-18	Situation 9, Range C . . . . .	2-40
2-19	Example of Sustainability . . . . .	2-46
3-1	Distribution of Data, Hypothetical Weapon-Squad Mix A and Mix B in Situation 1 . . . . .	3-14
3-2	Distribution of Data, Hypothetical Weapon-Squad Mix C in Situation 2 . . . . .	3-15
3-3	Example of CET as a Function of Range . . . . .	3-17
3-4	Histogram (Bar Graph) Presentation, Near Misses as a Function of Target Location . . . . .	3-19



CONTENTS (Continued)

4-1	Disassembly Time of Rifles . . . . .	4-4
4-2	Assembly Time of Rifles . . . . .	4-5
4-3	Disassembly Time of Automatic Rifles . . . . .	4-11
4-4	Assembly Time of Automatic Rifles . . . . .	4-12
4-5	Disassembly Time of Machineguns . . . . .	4-15
4-6	Assembly Time of Machineguns . . . . .	4-16
4-7	Range 19 Record Scores as a Function of Time of Day . . . . .	4-19
4-8	Range 18 Record Scores as a Function of Haze Conditions . . . . .	4-19
4-9	Rifle Squad Technique of Fire Range (Linear Targets) . . . . .	4-20
4-10	Rifle Squad Technique of Fire Range (Oblique Targets) . . . . .	4-21
4-11	Rifle Squad in Approach to Contact Range . . . . .	4-22
4-12	Rifle Squad in Assault Range . . . . .	4-23
4-13	Squad in Defense Range (Rifle or Machinegun) . . . . .	4-24
4-14	Machinegun Support of Attack Range . . . . .	4-25
4-15	Machinegun Support of Assault Range . . . . .	4-26
6-1	Summary of Results--Situation 1 . . . . .	6-5
6-2	Vertical Profile--Situation 1 . . . . .	6-7
6-3	Cumulative Number of Near Misses and Targets Hit--Situation 1 . . . . .	6-8
6-4	Number and Distribution of Near Misses --Situation 1 . . . . .	6-14
6-5	Summary of Results--Situation 2 . . . . .	6-23
6-6	Vertical Profiles--Situation 2 . . . . .	6-25
6-7	Cumulative Number of Rounds Fired, Targets Hit, Near Misses, and Percent of Ammunition Remaining--Situation 2 . . . . .	6-26
6-8	Number and Distribution of Near Misses --Situation 2 . . . . .	6-32

CONTENTS (Continued)

6-9	Summary of Results--Situation 4 . . . . .	6-41
6-10	Cumulative Number of Targets Hit and Percent of Ammunition Remaining--Situation 4 . . . . .	6-43
6-11	Summary of Results--Situation 5 . . . . .	6-51
6-12	Summary of Results--Situation 5 (Array X) . . . . .	6-53
6-13	Summary of Results--Situation 5 (Array Y) . . . . .	6-55
6-14	Cumulative Number of Rounds Fired, Targets Hit, Near Misses, and Percent of Ammunition Remaining--Situation 5 . . . . .	6-57
6-15	Number and Distribution of Near Misses--Situation 5 . . . . .	6-63
6-16	Summary of Results--Situation 7 . . . . .	6-71
6-17	Cumulative Exposure Time, Targets Hit, Rounds Fired, Total Hits, and Percent of Ammunition Remaining . . . . .	6-73
6-18	Summary of Results--Situation 8 . . . . .	6-81
6-19	Cumulative Exposure Time--Situation 8 . . . . .	6-83
7-1	Cumulative Number of Targets Hit--Situation 1 . . . . .	7-7
7-2	Number and Distribution of Near Misses--Situation 1 . . . . .	7-8
7-3	Cumulative Number of Targets Hit--Situation 2 . . . . .	7-9
7-4	Number and Distribution of Near Misses--Situation 2 . . . . .	7-10
7-5	Cumulative Number of Targets Hit--Situation 4 . . . . .	7-11
7-6	Cumulative Number of Targets Hit--Situation 5 . . . . .	7-12
7-7	Number and Distribution of Near Misses--Situation 5 . . . . .	7-13
7-8	Cumulative Exposure Time--Situation 7 . . . . .	7-14
7-9	Cumulative Exposure Time--Situation 8 . . . . .	7-14
7-10	Cumulative Number of Targets Hit . . . . .	7-25
7-11	Cumulative Exposure Time . . . . .	7-27
7-12	Number and Distribution of Near Misses--Situation 1 . . . . .	7-28

CONTENTS (Continued)

7-13	Cumulative Number of Targets Hit-- Situation 3 . . . . .	7-34
7-13	Cumulative Number of Targets Hit-- Situation 4 . . . . .	7-35
7-14	Number and Distribution of Near Misses --Situation 3 . . . . .	7-36
7-14	Number and Distribution of Near Misses --Situation 6 . . . . .	7-37
7-15	Cumulative Exposure Time--Situation 9 . . . . .	7-38
 Tables		
2-1	Comparative Weight and Ammunition Basic Loads by Weapons . . . . .	2-9
2-2	Squad Weapon Mixes and Squad Ammunition Basic Loads . . . . .	2-12
2-3	Basic Marksmanship Rifle Instruction . . . . .	2-17
2-4	Basic Marksmanship Automatic Rifle Instruction . . . . .	2-19
2-5	Basic Marksmanship Machinegun Instruction . . . . .	2-19
2-6	Transition Training . . . . .	2-20
2-7	Personnel Trained and Cross-trained . . . . .	2-21
2-8	Hypothetical Example of Cumulative Exposure Time (CET) . . . . .	2-45
Subtable A	Cumulative Exposure Times . . . . .	3-5
Subtable H	Cumulative Exposure Time p Factors . . . . .	3-5
4-1	Rifle and Assembly Test . . . . .	4-2
4-2	Rifle Record Fire Qualification Scores . . . . .	4-6
4-3	Average Number of Hits by Rifle in Automatic Mode (25-meter Range) . . . . .	4-8
4-4	Average Number of Hits by Rifle in Automatic Mode (200-meter Range) . . . . .	4-8
4-5	Automatic Rifle Disassembly and Assembly Tests . . . . .	4-10
4-6	Automatic Rifle Interim Transition Record . . . . .	4-13
4-7	Automatic Rifle Average Hits Underarm (Unsupported) and Hip/ling Positions (25-meter Range) . . . . .	4-13

CONTENTS (Concluded)

4-8	Machinegun Disassembly and Assembly Tests . . . . .	4-14
4-9	Machinegun Tables II, III, IV Average Number of Hits . . . . .	4-17
5-1	Malfunctions and Stoppages of Weapons . . . . .	5-3
5-2	Malfunctions Rates . . . . .	5-5
Table a	Sum of Raw Scores Across All Targets (Events Weighted Unequally) . . . . .	6-38
Table b	Average of 12 Event Standard Scores (Events Weighted Equally) . . . . .	6-38
Table c	Ambush Event (10 Targets - 21 to 34 Meters) . . . . .	6-39
6-1	Effects of Special Weapon Mixes . . . . .	6-94
6-2	Comparative Scores of Special Weapon Mixes . . . . .	6-97
7-1	Raw Score Results (Rifle Duplex Experiment) . . . . .	7-2
7-2	Expected Duplex Score (Rifle Duplex Experiment) . . . . .	7-5
7-3	Expected Duplex Scores Compared With Top Ranked Rifle Mixes (Rifle Duplex Experiment) . . . . .	7-16
7-4	Raw Score Results (Automatic Rifle Duplex Experiment) . . . . .	7-19
7-5	Expected Duplex Scores (Automatic Rifle Duplex Experiment) . . . . .	7-21
7-6	Raw Score Results (Machinegun Duplex Experiment) . . . . .	7-23
7-7	Expected Duplex Scores (Machinegun Duplex Experiment) . . . . .	7-32

## ABSTRACT

Field experimentation was conducted to determine the relative effectiveness of rifle and machinegun squads armed with US 7.62mm, Soviet 7.62mm, Colt 5.56mm and Stoner 5.56mm weapons. This report describes the experiment, the effectiveness measures used, the results, and the conclusions. Results are concerned with training, materiel reliability, and the fire effectiveness of squads armed with the different weapons and firing both simplex and duplex ball ammunition. Measures of effectiveness were the level of target effects and the ability of the weapons to sustain the effects. Data includes the number of targets hit, total number of hits on targets, number of near misses as an indication of suppressive effects, and the amount of ammunition expended--all as a function of time. Squad size, organization, and weapon system weight were held constant.

Squads armed with low impulse 5.56mm weapons were superior to squads armed with 7.62mm weapons in target effects, sustainability of effects, and overall effectiveness. Duplex ball ammunition was generally superior to simplex ball ammunition at close ranges. Data are related to lethality indices in a separate classified annex. Considerations of lethality support experimentation results indicating the superiority of 5.56mm weapons.

## **FOR OFFICIAL USE ONLY**

### **SECTION I**

#### **INTRODUCTION**

This report describes USACDCEC SAWS (small arms weapon systems) field experimentation completed 21 February 1966. A previous USACDCEC SAWS report, dated 31 January 1966, included only the experimentation completed by 24 December 1965.

This report supersedes the 31 January report, updating it with the field experimentation and associated analyses conducted after 24 December. All conclusions of the previous report remain valid, but they have been supplemented. Additional input data refinements and a more precise treatment of computer produced data have resulted in some changes in the numerical data presented for some of the experimental situations. These data refinements accentuate and clarify differences in weapon mixes presented in the 31 January report but result in no significant changes in either the performance measures or the rank order of weapons.

The report consists of nine sections. This first section identifies the purpose, scope, objectives, phasing and location, concept and general conduct of the experiment. Section II details the experimentation design, including a description of the experimentation ranges and the effectiveness criteria used. Section III explains the method of data presentation and analysis. Sections IV, V, and VI present the results of the experiment as related to training, materiel reliability, and fire effectiveness, and Section VII presents the results of an experiment comparing simplex ball and duplex ball ammunition. Section VIII consists of a brief note on the implications of existing lethality data to the SAWS findings, referring the reader to a separate classified annex for the primary lethality analysis. Major USACDCEC conclusions of the SAWS experiment and analysis are presented in Section IX. Reference data are contained in Annexes A through C. A separate volume is planned to provide detailed engineering design information and specifications of the instrumentation used in the SAWS experiment.

#### **A. PURPOSE**

The purpose of the SAWS field experiment was to assist in the evaluation of designated candidate small arms weapon systems as part of the Army-wide SAWS program.

#### **B. SCOPE**

The following specific experimentation tasks were assigned by USACDC directives:

1. Determination of the relative fire effectiveness of dismounted squads armed with various mixes of rifles, automatic rifles, and machine-guns, including Soviet-type weapons.

2. Determination of the relative fire effectiveness of squads armed with standard US 7.62mm weapons firing duplex ball ammunition, compared with squads firing ball ammunition.

3. Provision of certain data, such as firing scores, that might provide some insight into the relative ease or quality of training afforded by the different weapon systems, as a byproduct of the preparatory training phase of the experiment.

### C. OBJECTIVES

The outline plan approved by USACDC assigned eight main objectives:

1. As a byproduct of experimental design, development of a quantitative effectiveness criterion by which rifle and machinegun squads armed with candidate weapon systems, can be compared under tactical conditions.

2. Provision of hard data for determining the combat effectiveness of candidate weapons within an organizational and tactical context.

3. Provision of data to assist in determining the increases or decreases, if any, in manpower implied by the candidate weapon systems for use in cost effectiveness analysis.

4. Provision of comparative data on the tactical ammunition consumption rates of candidate weapons, relative to target effects achieved, as one input into cost effectiveness studies of increases or decreases in ammunition requirements implied by the various weapons.

5. As a byproduct of the preparatory training phase of the experiment, provision of data on the relative training effectiveness of the candidate weapons.

6. Identification of weapon characteristics that produced superior fire effectiveness within an experimental organizational and tactical context.

7. Provision of data resulting from the field experimentation for use in computer simulation.

8. Contribution to such Infantry Rifle Unit Study (IRUS) answers as the SAWS project can practically afford without prejudice to the constraints of time, resources, and SAWS objectives.

#### D. PHASING AND LOCATION

The experiment was accomplished at Fort Ord in four phases.

Phase I -- Preparation (23 February 1965-30 September 1965)

Phase II -- Training (24 August 1965-21 October 1965)

Phase III -- Field Experimentation (22 October 1965-21 February 1966)

First Increment (22 October 1965-24 December 1965)

Second Increment (3 January 1966-21 February 1966)

Phase IV -- Analysis and Reporting (18 December 1965-10 May 1966)

#### E. CONCEPT

The experiment was conducted to determine the relative fire effectiveness of rifle squads and machinegun squads armed with candidate weapons in the context of rifle platoons and companies in various tactical situations. Squad weapon system weight and the size and control structure of the squad were held constant. Squads were armed with the candidate weapon systems and Soviet-type weapons. The squads were then employed in the same representative tactical situations on instrumented ranges using selected firing techniques.

The experiment was unique because it integrated the following related aspects of the experimental design:

- 1) Evolution and application of a meaningful measure of combat fire effectiveness of infantry squads
- 2) Procurement and installation of instrumentation to sense and record events that supported the measure of fire effectiveness as a function of time and target arrays that realistically simulate an enemy in tactical situations
- 3) Assignment of enough soldiers (975) as experimentation subjects to allow the assignment of six independent squads to each weapon mix, permitting a balancing of runs to reduce the effects of differences in individuals and extraneous variables in the environment.



## F. CONDUCT OF EXPERIMENT

The experiment was designed to provide immediate answers for the SAWS evaluation while concurrently making a long term contribution to knowledge of the effectiveness of infantry small arms in a tactical and organizational context in support of IRUS.

USACDCEC used 975 experimentation subjects in the experiment, with the subjects organized into infantry squads armed with candidate weapon mixes. The squad weapon mixes were evaluated in nine meaningful tactical situations on three instrumented ranges. A total of 1007 record runs were conducted.

The field experiment was conducted in a platoon framework employing nine-man rifle squads and seven-man machinegun squads. The instrumented ranges provided target arrays consisting of targets that simulated the important aiming cues associated with personnel targets. The design of the instrumentation permitted collection of target hits, near misses, and rounds fired as a function of time, all of which can be related to various combat firing distances. The sensing and recording of data was largely automated. The large number of record runs and the depth of data established a data base that has been only partially analyzed for this report.

Formal weapon training was conducted to ensure that all personnel were equally qualified, to the extent possible, to participate as experimentation subjects.

Exploratory firing was conducted to obtain data for assessing best firing techniques, to identify operational policies, to validate safety and control procedures, and to evolve the most meaningful tactical situations.

The first increment of field experimentation, conducted from 22 October 1965 to 24 December 1965, addressed the objectives assigned and provided the data base for the initial findings and main conclusions of the 31 January 1966 report. The first increment also identified the need for additional high priority experimentation. This follow-on experimentation, from 3 January to 21 February 1966, completed the initially planned and follow-on experiments. Completion of this additional field experimentation has allowed the initial findings to be refined and expanded.

## SECTION II EXPERIMENTAL DESIGN

Part A describes the general characteristics of the experiment. Part B describes the weapons used in the experiment and the manner in which they were organized into mixes of weapon types in a squad context. Part C provides a broad general description of the instrumentation and equipment used in the experiment. (A detailed description of instrumentation appears in Annex B.) Part D discusses the organization, control, and training of personnel. (The training programs and implications of training for the various weapons are more fully discussed in Section IV.) Part E details experimentation procedures, including operational policies and administrative procedures. The control and balance of experimental variables is discussed in this section. Part F details each of the experimental tactical situations used to evaluate the performance of the various weapon mixes. The SAWS combat effectiveness criteria are outlined in Part G, and their value in the SAWS analysis is discussed here.

### A. GENERAL CHARACTERISTICS OF THE DESIGN

The USACDCEC field experiment was designed to measure the fire effectiveness of three US and one foreign weapon families in a small unit organizational context and in representative tactical situations. To achieve this objective, three tactical ranges were constructed, each representing separate but related squad tactical situations. Each range provided two rifle squad situations and one machinegun squad situation; the experiment encompassed six rifle squad and three machinegun squad scenarios.

Instrumented target arrays were laid out for each tactical situation and targets were programmed to appear to the experimentation subjects, in conjunction with the firing of weapons simulators, in a way that would provide subjects visual and audible target cues normally encountered in combat. Instrumentation designed to measure near misses in relation to targets was used on two of the ranges. All target elements were designed to detect hits (and some to detect near misses) as a function of time. Important qualities of the experiment are the recording of events as a function of time and the inclusion of near misses as an indication of suppressive effects. Included in the experiment are three primary design elements: 1) the competing weapons and their associated mixes within a constant size organization, 2) the targets and their associated instrumentation, and 3) the tactical situations embodied in the three ranges.

**B. EXPERIMENTATION MATERIEL**

**1. Weapons and Ammunition**

The experimentation weapons consisted of 13 weapons of four families. The weapons, listed below, are illustrated in Figures 2-1 through 2-4.

<u>US 7.62mm</u>	<u>Colt 5.56mm</u>	<u>Stoner 5.56mm</u>	<u>Soviet 7.62mm</u>
M14 rifle	M16E1 rifle	Stoner rifle	AK47 rifle
M14E2 AR*	Colt AR	Stoner AR	- - -
M60 bipod MG**	- - -	Stoner bipod MG	RPD (squad level) bipod MG
M60 tripod MG	- - -	Stoner tripod MG	DPM (company level) bipod MG

Weapons of the US 7.62mm family and the M16E1 rifle of the Colt family are currently standard US weapons. The other 5.56mm weapons (Colt automatic rifle and Stoner family) are US developmental weapons. Weapons of the Soviet family are Soviet-type weapons found in several armies. Those used in the experiment were manufactured in East Germany, the Soviet Union, and Communist China; parts and ammunition were interchangeable. The Stoner family was designed for maximum interchangeability of parts and components between weapon types, although the other weapon families also possess varying degrees of interchangeability of parts between weapon types.

A basic purpose of this experiment, implied in the candidate weapons selected, was to evaluate fire effectiveness of low muzzle impulse and high muzzle impulse weapons.\*\*\* The Stoner and Colt 5.56mm systems are of the low muzzle impulse type. The standard US 7.62mm weapons are high muzzle impulse weapons firing the standard US 7.62mm (NATO) cartridge. The Soviet rifle and RPD squad-level machinegun cartridges are considered intermediate impulse cartridges, while the Soviet company-level machinegun (DPM) fires a cartridge with energy similar to the US 7.62mm (NATO) cartridge. Figure 2-5 illustrates the ammunition types used in the SAWS Field Experiment.

The nominally standard US 7.62mm duplex cartridge has two tandem loaded 7.62mm projectiles that together weigh slightly more than

\* AR - Automatic Rifle

\*\* MG - Machinegun

\*\*\* Table C-6 (Annex C) presents the comparative ammunition characteristics of low impulse 5.56mm ammunition and high impulse US 7.62mm ammunition.

M14 Rifle

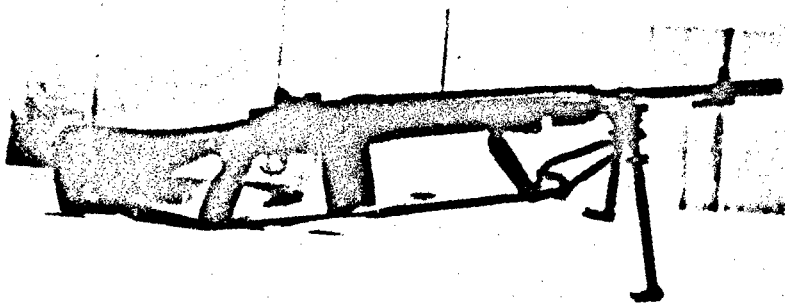
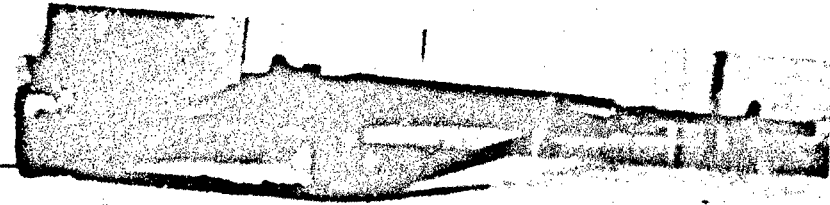

M14E2 Automatic Rifle

M60 Machinegun, Bipod Mounted

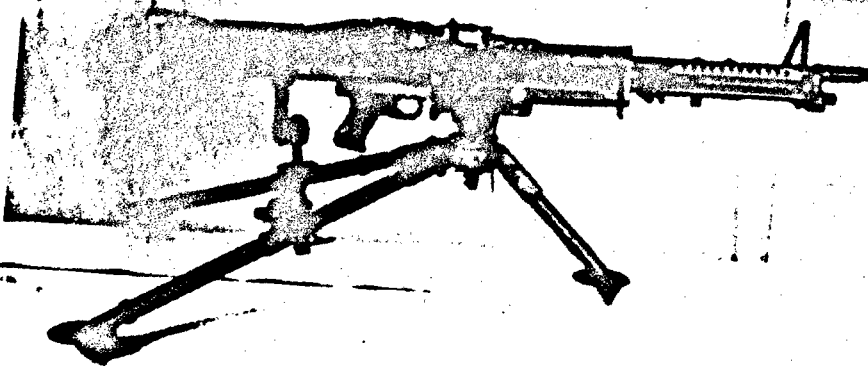
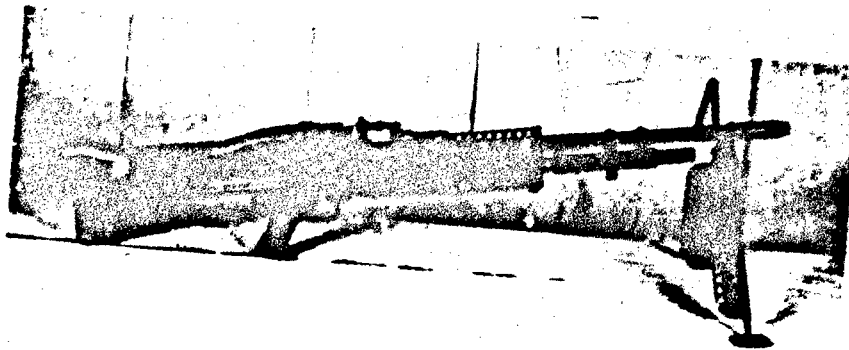

M60 Machinegun, Tripod Mounted

Figure 2-1 US 7.62mm WEAPONS

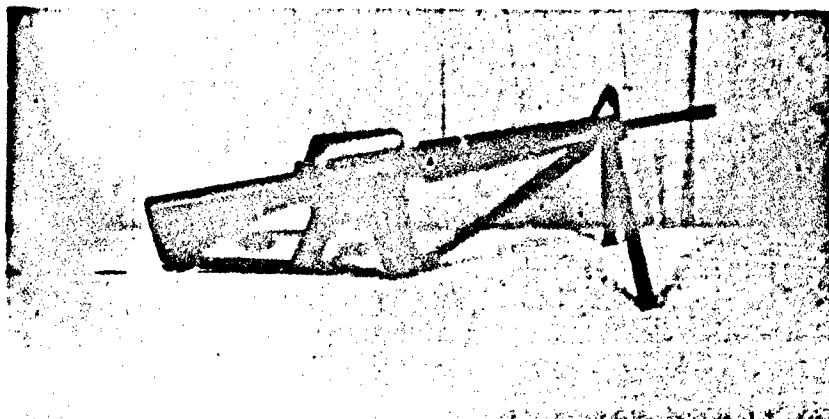

**M16E1 Rifle**

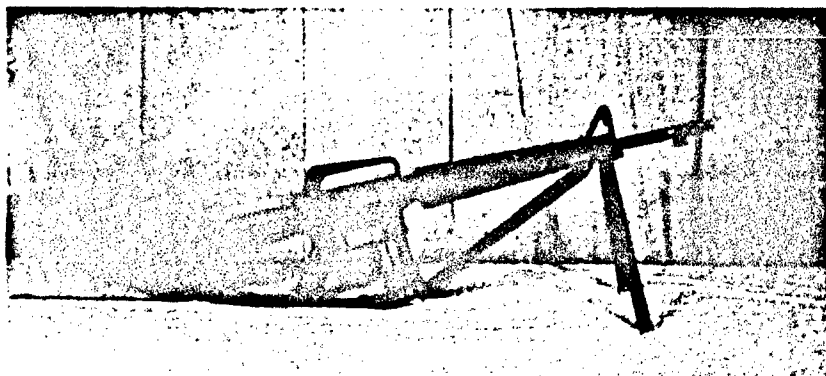

**Colt Automatic Rifle**

**Figure 2-2 COLT 5.56mm WEAPONS**

Rifle

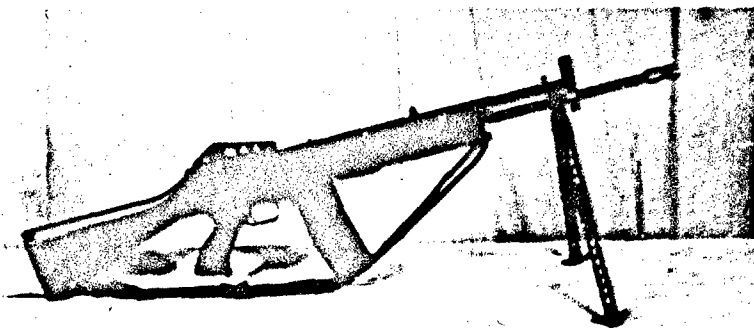

Automatic Rifle

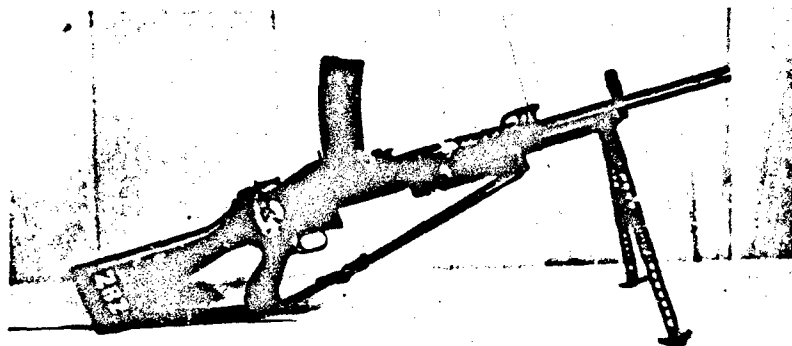

Machinegun,  
Bipod Mounted

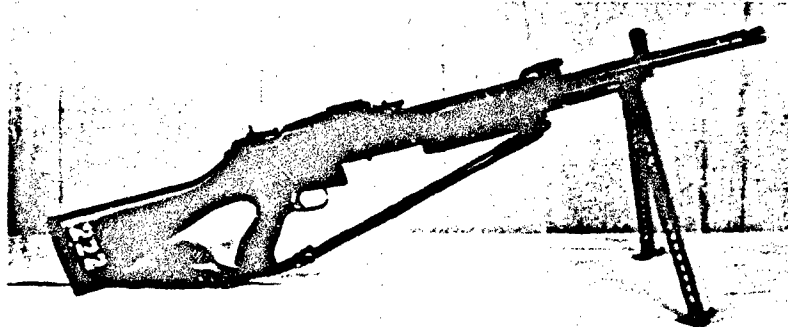

Machinegun,  
Tripod Mounted

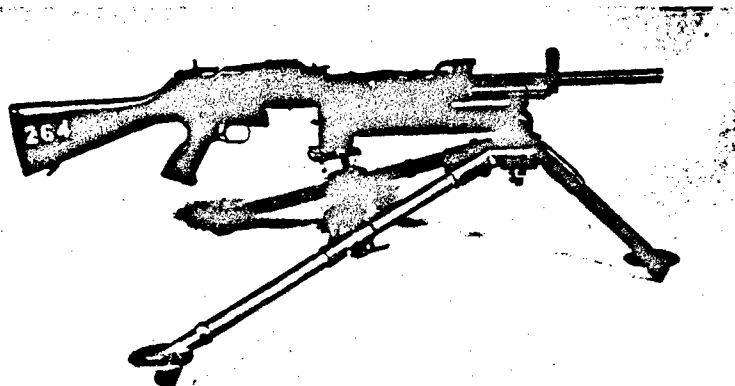
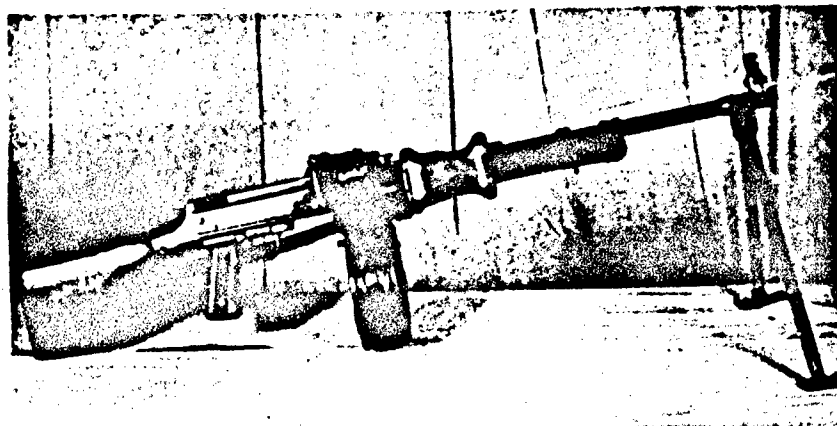
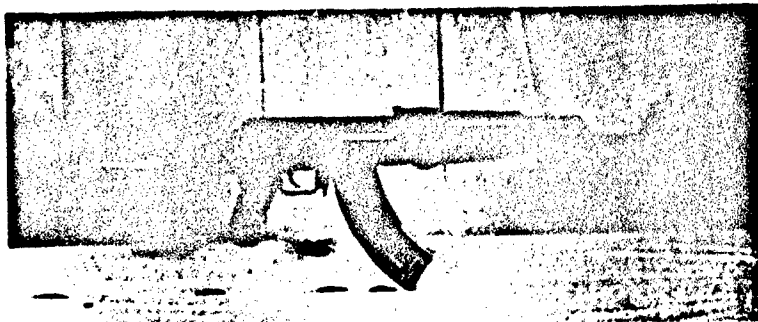
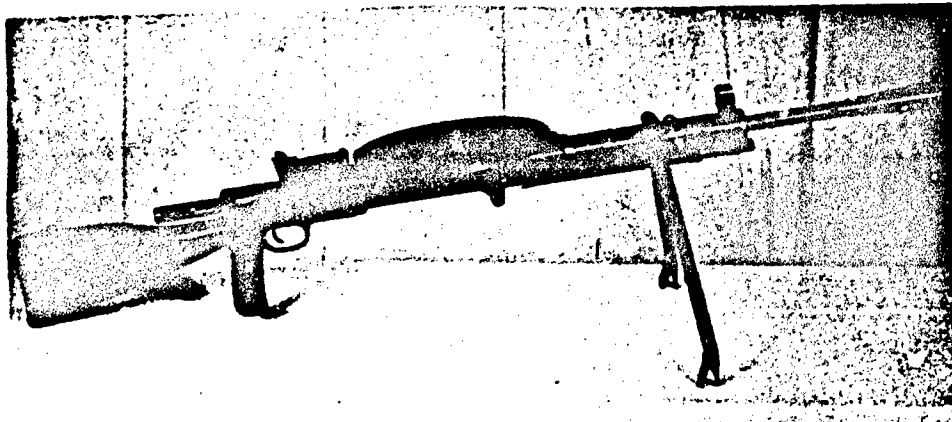

Figure 2-3 STONER 63 5.56mm WEAPONS  
2-5

AK47 Rifle



RPD Machinegun,  
Bipod Mounted



DPM Machinegun, Bipod Mounted

Figure 2-4 SOVIET-TYPE 7.62mm WEAPONS

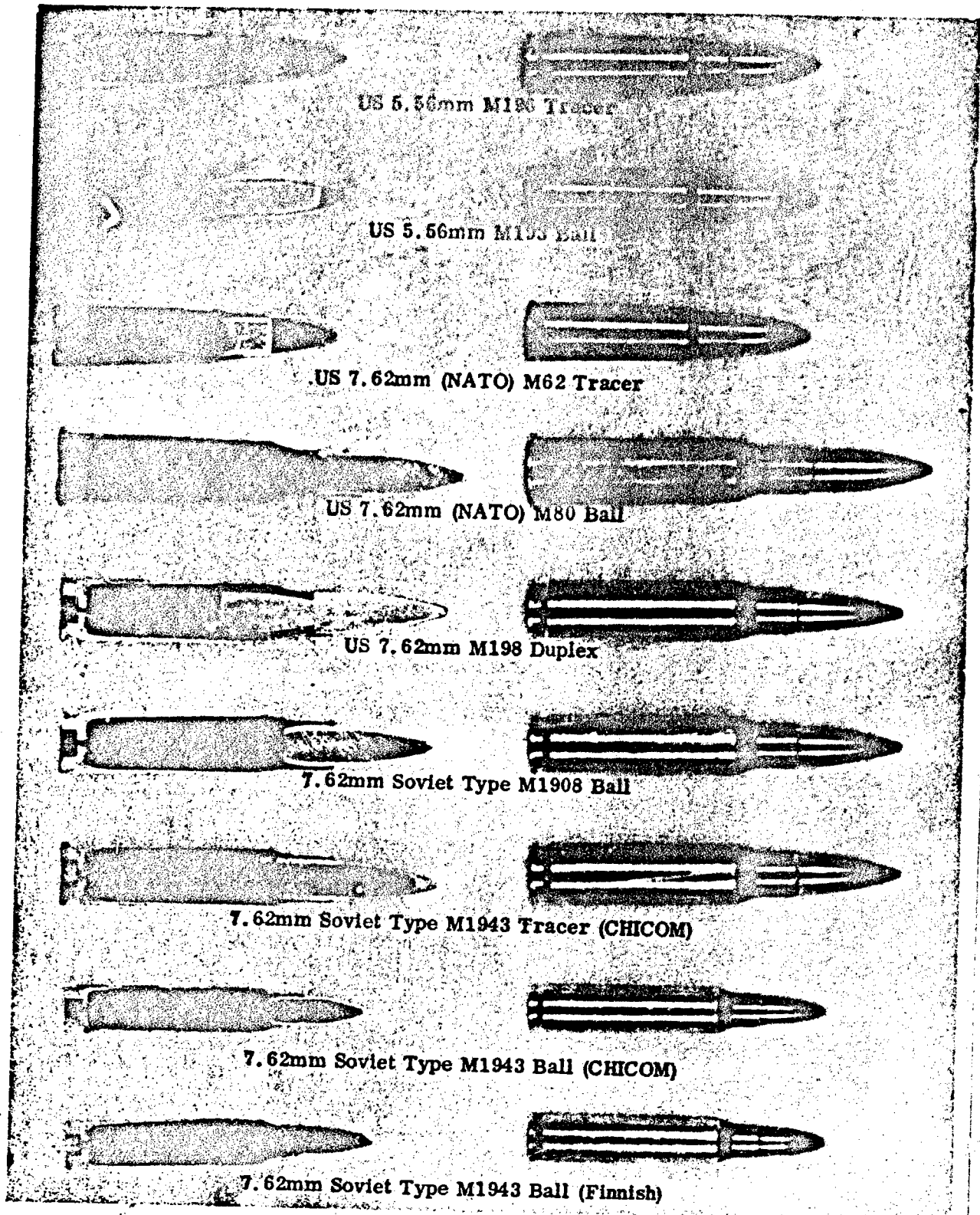

Figure 2-5 TYPES OF AMMUNITION



the standard simplex projectile and have a lower velocity than the simplex round. The duplex round was designed to increase hit probability at ranges to about 300 meters.

Details of weapons and ammunition characteristics are listed in Annex C.

The candidate weapons, ammunition, and spare parts for the experiment were selected and provided by the Army Materiel Command (AMC). Except for the Soviet-type weapons, the weapons were in new condition when USACDCEC received them.

Weight characteristics of the candidate and Soviet weapons are summarized in Table 2-1. This table also shows the weapon ammunition basic loads used in this experiment. System weights used in determining the relative fire effectiveness of the experimentation weapons were those of the current standard 7.62mm weapons with currently prescribed basic loads. These weights were adopted to hold squad systems weight constant and the weights represent current Army weight doctrine; these current ammunition loads have been determined to approach the maximum permissible weight and to be heavier than desirable.\* For detailed comparative data on weapons and ammunition, see Annex C.

## 2. Organization of Materiel for Experimentation

For comparisons, system weights and the size and structure of the squad were held constant, but the weapon mixes were varied. These mixes are shown in Table 2-2.\*\* Squad ammunition basic loads for these weapon mixes, based on the individual weapon loads given in Table 2-1, are also shown in Table 2-2.

## C. INSTRUMENTATION

On each range were instrumented target arrays connected by buried cables to a control and recording van behind the firers. Each target element of an array consisted of some or all of the following components:

- 1) A target body with a hit sensor, representing a kneeling or standing soldier or the head and

\* A Study to Conserve the Energy of the Combat Infantryman, USACDC, 5 February 1964.

\*\* The squad weapons mixes were selected to permit comparison of the weapons for the SAWS experiment; they were also designed to provide building blocks of data that could be used, with an IRUS scaling experiment, to compute the small arms fire effectiveness of alternative squad, platoon, and company organization.

Table 2-1  
COMPARATIVE WEIGHT AND AMMUNITION BASIC LOAD

Item	Rifles in Rifle Squad					ARs and MGs in Rifle Squads				
	M14	M14E2	M16E1	Stoner	AK47	M14E2	Colt AR	Stoner AR	M60 Bipod MG	Stoner Bl MG
Weapon (unloaded)	9.69 lb	12.56 lb	6.87 lb	8.25 lb	8.75 lb	12.56 lb	8.00 lb	10.62 lb	24.37 lb	11.44 lb
Weapon (loaded)	11.27 lb	14.14 lb	7.87 lb <sup>A</sup>	9.52 lb <sup>B</sup>	10.87 lb <sup>B</sup>	14.14 lb	9.00 lb <sup>A</sup>	11.89 lb <sup>B</sup>	31.77 lb <sup>C</sup>	16.43 lb
Bipod and case		c	0.75 lb	1.32 lb		c	0.75 lb	1.32 lb	c	1.32 lb
Bipod										
Carbine barrel kit										
Ammunitions available at system weight current in Army 7.62mm weapon <sup>N</sup>	100 rd 17.59 lb	60 rd <sup>D</sup> (17.30 lb)	300 rd (17.62 lb)	180 rd (17.19 lb)	120 rd (17.23 lb)	260 rd 33.10 lb	724 rd (33.10 lb)	492 rd (33.08 lb)	120 rd <sup>H</sup> (33.08 lb)	600 rd (32.72 lb)
Weapon system weight equal numbers of rounds	17.59 lb 100 rd	20.46 lb (100 rd)	11.12 lb (100 rd)	14.15 lb (100 rd)	16.44 lb (100 rd)	33.10 lb 260 rd	17.50 lb (260 rd)	23.12 lb (260 rd)	48.41 lb <sup>I</sup> (260 rd)	21.56 lb (260 rd)

NOTE: System weights and ammunition basic loads for all weapons in rifle squad on one-man loads. Those for machinegun squads are based on three-man (a three-man gun team).

<sup>A</sup> 30-round aluminum magazine

<sup>B</sup> 30-round steel magazine

<sup>C</sup> Bipod organic to the weapon

<sup>D</sup> 60 rounds at rifle system weight; however, 80 rounds were allowed

<sup>E</sup> 100-round bandoleer

<sup>F</sup> 150-round bandoleer

<sup>G</sup> 100-round drum

<sup>H</sup> A rifleman was used as a caliber .45 pistol. Computed (17.59 lb) and the gunner ammunition in bandoleer

<sup>I</sup> Includes weight of the pistol

<sup>J</sup> 47-round drum

<sup>K</sup> 200-round metal box

<sup>L</sup> 900-round metal box

<sup>M</sup> System weight is based on 60 rounds of ammunition in bandoleer for assistant gunner and 60 rounds for rifleman

<sup>N</sup> Computed on the basis of cartridge is 5.55 percent

<sup>O</sup> Three 900-round metal boxes

**Table 2-1  
AMMUNITION BASIC LOADS BY WEAPON**

ARs and MGs in Rifle Squads				MGs in Machinegun Squads					
Stoner AR	M60 Bipod MG	Stoner Bipod MG	RPD MG	M60 Tripod MG	Stoner Tripod MG	DPM MG	M60 Bipod MG	Stoner Bipod MG	RPD MG
10.62 lb	24.37 lb	11.44 lb	14.93 lb	24.06 lb	10.81 lb	22.00 lb	24.37 lb	11.44 lb	14.93 lb
11.89 lb <sup>b</sup>	31.77 lb <sup>e</sup>	16.43 lb <sup>f</sup>	20.66 lb <sup>c</sup>	31.46 lb <sup>e</sup>	15.80 lb <sup>f</sup>	27.70 lb <sup>j</sup>	31.77 lb <sup>e</sup>	16.43 lb <sup>f</sup>	20.66 lb <sup>c</sup>
1.32 lb	c	1.32 lb	c			c	c	1.32 lb	c
				17.37 lb	19.37 lb				
				12.56 lb	5.87 lb	4.88 lb	12.56 lb	5.87 lb	
492 rd (33.08 lb)	120 rd <sup>m</sup> (33.08 lb)	600 rd (32.72 lb)	300 rd <sup>c</sup> (32.12 lb)	800 rd 129.65 lb <sup>m</sup> 900 rd 129.49 lb	2298 rd <sup>l</sup> (120.63 lb) 2545 rd <sup>f</sup> (129.63 lb)	752 rd <sup>j</sup> (126.98 lb)	1000 rd <sup>k</sup> (129.28 lb) 1123 rd <sup>e</sup> (129.60 lb)	2850 rd <sup>o</sup> (129.06 lb) 3059 rd <sup>f</sup> (129.63 lb)	1833 rd <sup>c</sup> (129.62 lb)
23.12 lb (260 rd)	48.41 lb <sup>i</sup> (260 rd)	21.56 lb (260 rd)	30.28 lb (260 rd)	129.65 lb 800 rd <sup>k</sup> 129.49 lb 900 rd <sup>e</sup>	74.18 lb (800 rd) <sup>l</sup> 74.89 lb (900 rd) <sup>f</sup>	132.73 lb (800 rd) <sup>j</sup>	112.59 lb (800 rd) <sup>k</sup> 112.43 lb (900 rd) <sup>e</sup>	56.76 lb (800 rd) <sup>l</sup> 57.47 lb (900 rd) <sup>f</sup>	69.67 lb (800 rd) <sup>c</sup>

basic loads for all weapons in rifle squads are based on three-man loads  
machinegun squads are based on three-man loads

<sup>m</sup> A rifleman was used as an ammunition bearer and armed with a caliber .45 pistol. Combined system weight for the rifleman (17.59 lb) and the gunner (33.10 lb) provided 294 rounds of ammunition in bandoleers for a total weight of 50.63 lb

<sup>b</sup> allowed <sup>i</sup> Includes weight of the pistol carried by the ammunition bearer

<sup>j</sup> 47-round drum

<sup>k</sup> 200-round metal box

<sup>l</sup> 900-round metal box

<sup>m</sup> System weight is based on weight of M60 tripod MG, 800 rounds of ammunition in metal boxes, and caliber .45 pistols for assistant gunner and ammunition bearer

<sup>n</sup> Computed on the basis of the ball cartridge, 7.62mm duplex cartridge is 5.55 percent heavier

<sup>o</sup> Three 900-round metal boxes plus a 150-round bandoleer

shoulders of a soldier in a foxhole, colored field green with a dirt-smearred decal face. (Figure 2-6)

- 2) A mechanism to raise and lower the target on computer command and to lower it when it was hit.
- 3) A target weapon signature simulator (weapon simulator) that provided realistic auditory and visual weapon cues of noise, blast and flash of a rifle, automatic rifle, or machinegun, according to computer programmed commands, and shut off when the target was hit (not all target elements had, or needed, simulators).
- 4) A near miss sensor to sense misses within 2 meters of the target body. These sensors were used for the target elements in five of the nine tactical situations. Two types of near miss sensors were used on different ranges: an acoustic sensor (Figure 2-7) at the shorter firing distances and a camouflaged panel sensor at the longer distances (Figure 2-8).

The individual target elements, grouped tactically in arrays, were programmed to give weapon signature cues and to raise and lower targets according to programmed exposure times. Exposure times were selected to portray movements representative of the combat situation being portrayed. The programmed total target exposure times for each situation are given in Appendix 4 to Annex B.

In addition to the target array instrumentation, microphones were placed at each static firing position to allow the rounds fired to be counted and recorded as a function of time. (Manual counts of remaining ammunition were made for the two tactical situations where experimentation subjects were moving.)

The control and recording van housed a control console and an on-line computer with a magnetic tape recorder. Reproducibility of target system behavior for each squad in a situation was provided by computer command program.

The following basic data were recorded as a function of time to the nearest 0.01 minute: hits (both first hits and any subsequent hits before the targets fell completely), near misses, target up and target

Table 2-2  
**SQUAD WEAPON MIXES AND SQUAD AMMUNITION BASIC LOADS A**

Nine-man rifle squad: squad leader and two four-man fire teams													
US 7.62mm Mix			Colt 5.56mm Mix			Stoner 5.56mm Mix			Soviet 7.62mm Mix			Hybrid Mix	
Weapons (No. and Type)	Load (rounds)		Weapons (No. and Type)	Load (rounds)		Weapons (No. and Type)	Load (rounds)		Weapons (No. and Type)	Load (rounds)		Weapons (No. and Type)	Load (rounds)
9 M14 rifles	1290		9 M16E1 rifles	3618		9 Stoner rifles	2352		9 AK47 rifles	1504		--	--
9 M14E2 rifles	1080		9 Colt ARs	3323		--	--		--	--		--	--
7 M14 rifles 2 M14E2 ARs	1220		7 M16E1 rifles 2 Colt ARs	3548		7 Stoner rifles 2 Stoner ARs	2244		--	--		--	--
5 M14 rifles 2 M60 bipod MGs	1088		-- --	-- --		7 Stoner rifles 2 Stoner bipod MGs	2460		7 AK47 rifles 2 RPD bipod MGs	1440		7 M16E1 rifles 2 Stoner bipod MGs	3322 <sup>B</sup>
Seven-man machinegun squad: squad leader and two three-man machinegun teams													
2 M60 bipod MGs	2246 <sup>C</sup>					2 Stoner bipod MGs	6118 <sup>C</sup>		2 RPD bipod MGs	3678			
2 M30 tripod MGs	1600 <sup>B</sup>					2 Stoner tripod MGs	4596 <sup>B</sup>		2 DPM bipod MGs	1504			

<sup>A</sup>Basic loads at equal squad weapon systems weight: 189.33 pounds for rifle squad and 259.30 pounds for machinegun squad (See Table 2-1)

<sup>B</sup>1200 rounds (in bandoleers) for MGs, 2122 rounds for rifles

<sup>C</sup>In bandoleers

<sup>D</sup>In boxes

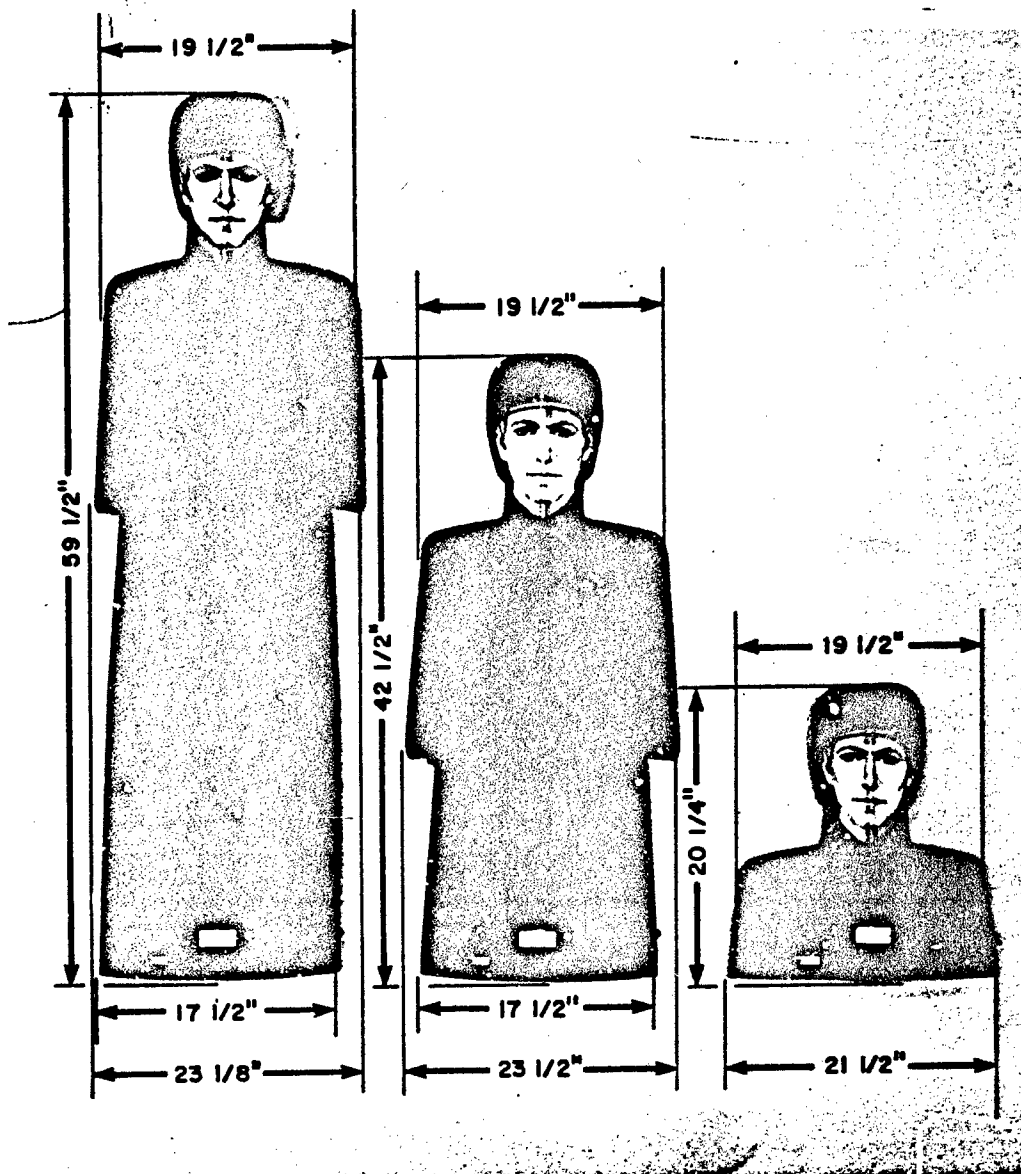

Figure 2-6  
STANDING, KNEELING, AND HEAD AND SHOULDER TARGETS  
(903, 623, 237 sq in. areas, respectively)

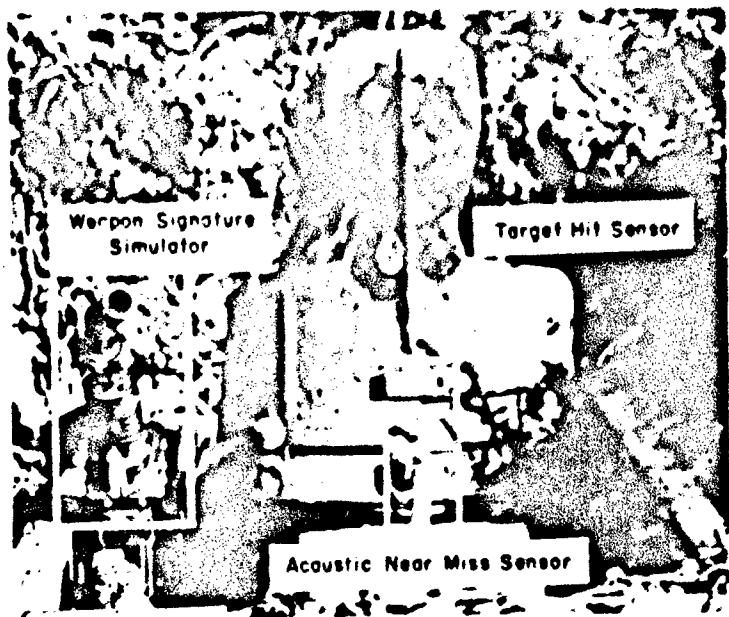

Figure 2-7 ACOUSTIC NEAR MISS SENSOR  
(Head and Shoulder Target)

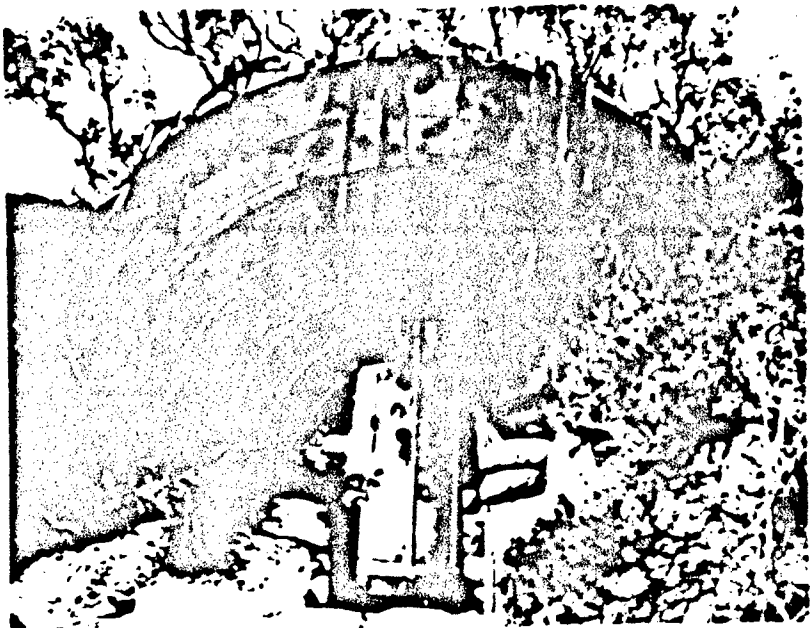

Figure 2-8 PANEL NEAR MISS SENSOR  
(Kneeling Target)

down, weapon signature simulator on and off, and rounds fired per weapon. The instrumentation was capable of discriminating between individual rounds to 5 milliseconds.

The instrumentation is described in further detail in Annex B. A supplemental detailed technical report will be published at a later date.

#### **D. EXPERIMENT PERSONNEL**

##### **1. Source of Support Personnel**

Support personnel for purposes of administrating and supporting the general conduct of the experiment (other than experimentation subjects) were from Project Team II, Experimentation Support Group, and the 194th Armored Brigade of USACDCEC.

##### **2. Source of Experimentation Subjects**

Experimentation subjects were provided by the 194th Armored Brigade. Subjects assigned to the six primary mixes--UA, UB, CA, CB, SA, and SB (the mixes equipped with nine rifles and with seven rifles and two automatic rifles)--were from infantry companies of the 41st Infantry Battalion. Subjects assigned to the other weapon mixes--SC, UC, UD, RA, and RC--were from armored and artillery units as well as from the 41st Infantry; they had all been previously trained and had qualified with the M14 rifle.

##### **3. Organization of Experimentation Subjects**

###### **a. Organization into Squad Weapon Mixes**

Experimentation subjects were organized into: (1) nine-man rifle squads consisting of a squad leader and two four-man fire teams, and (2) seven-man machinegun squads consisting of a squad leader, two machinegunners, two assistant machinegunners, and two ammunition bearers.

###### **b. Sample Size - Implications**

As far as practical, to randomize and balance uncontrolled variables--such as differences in the abilities of experimentation subjects, effects of weather, the effects of time of day (especially light), changing conditions of vegetation, and the motivational effects of proximity to weekends and holidays--six squads were assigned to each weapon mix. The use of six squads allowed them to be scheduled to fire in balanced matrices in each tactical situation with respect to date and time of day. A total of 105 squads, consisting of 975 experimentation subjects (including super-numeraries) was required.



**c. Matching of Personnel**

The number of personnel available allowed them to be assigned initially at random, on the basis of 72 men to the rifle mix--six nine-man experimentation squads plus nine-man squads from which supernumeraries were drawn to replace personnel lost for illness or other reasons--and 42 men to the machinegun mix. On completing the training phase, subjects were reassigned within their weapon type. The same number of experts, sharpshooters, and marksmen were assigned to each experimentation squad within a mix.

To conduct the experiment, special measures had to be taken to select experimentation subjects that could be retained for each phase of the experiment and, where necessary, to obtain their deferment from overseas levy.

Personnel records of all personnel were reviewed and cataloged, both at the time of initial assignment and at the completion of training, to ensure that personnel of all mixes were as closely equivalent as possible on all variables that could be expected to correlate with performance.

**4. Training Program for Experimentation Subjects**

The training phase of the experiment was conducted from 24 August to 21 October 1965 on Fort Ord Infantry Training Center ranges. Results of training tests and an analysis of the SAWS training program appear in Section IV (Training Results).

**a. Training Objectives**

Training objectives were to make all personnel proficient with their respective SAWS weapons, and to obtain data on the relative effectiveness of training inherent to the various weapons.

**b. Training Program**

The training program consisted of basic marksmanship and transition training, and followed current Army marksmanship courses outlined in Army Subject Schedules 7-111 and 7-112 dated November 1964; FM 23-71 dated July 1964; FM 23-16 dated June 1965; and FM 23-67 dated October 1964.

**(1) Basic Marksmanship Instruction**

Basic marksmanship instruction included mechanical training, instructional and qualification firing, target detection, and night firing. Where weapon differences prevented combined training--for

**Table 2-3  
BASIC MARKSMANSHIP  
RIFLE INSTRUCTION**

Subject	Total Hours	Ammunition per Firer
Orientation and Mechanical Training	4	0
Target Detection	6	0
Preparatory Marksmanship (25 meter firing)	14	132
Field Firing	4	56
Record Firing (includes 3 hours of concurrent target detection)	16	192
Night Firing	5	44
Familiarization of Automatic Technique	12	258
<b>Total</b>	<b>61</b>	<b>682</b>

**NOTE:** Modifications to Combat Readiness Marksmanship Proficiency Standard Course A1: Orientation and Mechanical Training was increased from 2 to 4 hours; Record Firing was increased from 8 to 16 hours to provide learning factors; Night Firing was increased from 2 to 5 hours to provide 3 hours of refresher on techniques; and familiarization of Automatic Fire Technique was included to prepare experimentation subjects for automatic firing with rifles.

example, mechanical training, sight adjustment and establishing battle-sight zero--qualified instructors using equivalent training aids and instructional material taught the experimentation subjects each weapon system separately. The hours of basic instruction presented are shown, with the ammunition used, in Tables 2-3, 2-4, 2-5, and summarized here:

Rifle Marksmanship (Combat                    61 hours  
Readiness Marksmanship  
Proficiency Standard Course

A-1, modified to include 12 hours of automatic fire)

Automatic Rifle Marksmanship 29 hours

Machinegun Marksmanship 34 hours  
(Tables I through VI)

**(2) Transition Training**

After completing basic marksmanship, rifle and machinegun squads were given separate transition training designed to train them to perform effectively as members of rifle and machinegun squads and to acquaint them with the safety and range procedures employed on the SAWS field experimentation ranges (Table 2-6).

Rifle squad transition training consisted of 24 hours of instruction as outlined in Army Subject Schedule 7-111 dated November 1964 and TC 23-9 dated January 1965. It included controlled tactical firing exercises in the approach to contact, assault, and defense.

Machinegun squad transition training consisted of eight hours of instruction in crew drill and controlled tactical firing exercises in support of the attack, support of the assault, and defensive firing.

**c. Supplementary Training**

Supplementary training was provided later to meet requirements caused by normal attrition and the need for new squads. This training was given at various times in November 1965, December 1965, and January 1966. The 228 personnel trained or cross trained as riflemen, automatic riflemen, or machinegunners are reflected in the totals shown in Table 2-7. Personnel who had received no previous training were given the full complement of training. Personnel being cross trained received instruction on disassembly, assembly, functioning, zero firing, automatic fire techniques, trigger manipulation, loading, and range safety as necessary. All personnel received equivalent amounts of training.

**d. Training Facilities**

Facilities used during training included classrooms and target detection and firing ranges. Infantry Training Center classrooms and ranges at Fort Ord were used during basic marksmanship training without modification. Sketches of ranges used for transition training appear in Section IV.

**Table 2-4  
BASIC MARKSMANSHIP  
AUTOMATIC RIFLE INSTRUCTION**

Subject	Total Hours	Ammunition per Firer
Orientation and Mechanical Training	2	0
Target Detection	2	0
Preparatory Marksmanship (25 meter firing)	12	236
Record Practice (Instructional Firing)	4	79
Record Practice (Qualification Firing)	4	74
Night Firing	5	104
<b>Total</b>	<b>29</b>	<b>493</b>

**NOTE:** Modifications to Army Subject Schedule 7-111: Mechanical Training was given to familiarize firers with new weapon systems; refresher training in Target Detection and Night Firing was given because these areas are covered in Basic Rifle Marksmanship Training of which this training is normally a part.

**Table 2-5  
BASIC MARKSMANSHIP  
MACHINEGUN INSTRUCTION**

Subject	Total Hours	Ammunition per Firer
Orientation and Mechanical Training	3	0
Bipod Firing (Table I)	4	42
Tripod Firing, Practice (Table II)	4	108
Tripod Firing, Record Practice (Table III)	4	78
Tripod Firing, Record (Table IV)	4	108
Transition Firing, Practice & Record (Table V)	8	396
Day Defensive Field Firing (Table VI)	7	200
<b>Total</b>	<b>34</b>	<b>932</b>

**NOTE:** Modifications to Army Subject Schedule 7-111: Mechanical Training was increased from 2 to 3 hours; Table VII (Assault Firing) and Table VIII (Day and Night Predetermined Firing) were deleted as not pertinent to the SAWS Experiment.

**Table 2-6  
TRANSITION TRAINING**

Subject	Total Hours	Ammunition * per Firer	
		Rifles	ARs
<b>Rifle Squad</b>			
Orientation	4	0	0
Squad Technique of Fire	4	20	40
Squad in the Approach to Contact	8	60	120
Squad in the Assault	4	100	260
Squad in the Defense	4	60	100
<b>Total</b>	<b>24</b>	<b>240</b>	<b>520</b>

Subject	Total Hours	Ammunition* per Firer
<b>Machinegun Squad</b>		
Support of Attack and Assault Firing	5	700
Defense Firing	3	200
<b>Total</b>	<b>8</b>	<b>900</b>

\* Indicates amount of ammunition allocated for the exercise, not necessarily amount expended which varied from firer to firer.

Table 2-7  
PERSONNEL TRAINED AND CROSS-TRAINED

Type Training	Personnel Trained (Initial Weapon) Training Course	Personnel Not Completing Training	M14 Riflemen Retrained		Stoner Riflemen Retrained	RPD MG Personnel Retrained	M60 Ammunition Bearers	Stoner Riflemen	MG Refamiliarization	Stoner MG Retrained in AR Role
			Completed Training	Did Not Complete Training						
<u>Riflemen</u>										
M14	184	9 <sup>A</sup>								
M14E2 (rifle role)	71	5 <sup>A</sup>								
Colt	128	3 <sup>A</sup>								
Stoner	128	12 <sup>A</sup>			8			4		
AK47	100	1 <sup>A</sup>								
<u>Automatic Riflemen</u>										
M14E2	16									11
Colt AR	16									
Stoner AR	16									
M60 MG (AR role)	16									
Stoner MG (AR role)	16									
RPD MG (AR role)	16									
<u>Machinemen</u>										
M60 (bipod)	46 <sup>C, D</sup>		24 <sup>B</sup>				3 <sup>C</sup>		12	
M60 (tripod)	40 <sup>E (F), G</sup>	1 <sup>A</sup>	24 <sup>D</sup>	1 <sup>A</sup>			(3) <sup>C</sup>		10	
Stoner (bipod)	40 <sup>C</sup>				24				10	16
Stoner (tripod)	37 <sup>C</sup>				23				14	
RPD (bipod)	15	15 <sup>B</sup>							13	
DPM (bipod with tripod group)	34 [14] <sup>B</sup>								8	
<b>TOTALS</b>	<b>975</b>	<b>46</b>	<b>48</b>	<b>1</b>	<b>47</b>	<b>6</b>	<b>3</b>	<b>4</b>	<b>66</b>	<b>29</b>

<sup>A</sup> Figures include personnel who were not sufficiently trained to be used in field experimentation because of PCS, death, hospitalization, AWOL, confinement, or emergency leave.

<sup>B</sup> Personnel did not complete original training because of ammunition shortages, but 14 completed training at a later date.

<sup>C</sup> Received both bipod and tripod training.

<sup>D</sup> To be used as ammunition bearers.

<sup>E</sup> Indicates same personnel as shown in column above marked with <sup>C</sup>.

[ ] indicates footnote applies to number within.

**e. Training Data Collected**

The following types of data were collected during training:

- 1) Timed disassembly and assembly of weapons
- 2) Hits on targets
- 3) Size and type of shot groups
- 4) Number of targets engaged and number hit
- 5) Round dispersion
- 6) Ammunition expenditure
- 7) Number and type of malfunctions
- 8) Individual qualification

The primary measures of training performance were the firing scores taken on various ranges at fixed points during training. Each time firing scores were taken, each weapon system group had had the same amount of training of the same kind under comparable conditions. Results of the training program and firing scores are given in Section IV (Training Results).

**E. EXPERIMENTATION PROCEDURES**

**1. Uniform Operational Policies - General**

Uniform operational policies established for each tactical situation included policies for the situation and for each type of weapon in each mix of each family. These policies governed the ammunition basic load, the burst length (for example, semiautomatic or two round), the ammunition mix (such as the ratio of ball to tracer), the firing position (shoulder pointed, for example), the type of support (with or without sling or bipod), and the type of weapon zero and sight setting. In addition, a standard policy was used for assigning sectors of fire and for assigning weapons to foxholes and to positions in moving formations. These policies and firing techniques were derived from standard doctrine and, where doctrine was not specific, from exploratory firing. They are tabulated by situation in Annex A.

**2. Control and Balance of Weapon Mix Structure and Equipment**

As discussed in paragraph D-3, firers assigned to each mix of weapons were matched, as far as possible. They were also matched in assignments to the weapon types in a mix. When tracers were used by only a portion of a mix (for example, automatic rifles) they were also used by the firers in corresponding positions in all other mixes. This ensured that differences in the mixes would be a function of weapon

differences, rather than tracer rounds employed.

The schedule of runs was equally balanced in a matrix, providing for randomizing and balancing out the effects of extraneous variables (paragraph E-3 of Section I).

When not in use, experimentation weapons were held in guarded vans, and periods of care and cleaning were supervised.

### 3. Modes of Fire

Doctrine and exploratory firing indicated that the best mode of fire for the M14 rifle was semiautomatic fire in all situations. Since the limited time available for the experiment did not permit use of more than one technique of fire for each weapon in each tactical situation, the M14 rifle was fired semiautomatically and the other candidate rifles were, with several exceptions, fired in two round bursts.\* Exceptions were the defense situations (Situations 7 and 8), where time permitted comparison of all rifles in both automatic and semiautomatic fire. Another exception was the base of fire situation in the attack against delaying action (Situation 5), where all rifles fired only semiautomatically. Automatic rifles and machineguns were fired, respectively, in identical burst lengths in each tactical situation.

### 4. Control for Differences in Firer Location and Opportunity

The effects of such differences in firer opportunity as intervisibility were controlled, as far as possible. The squad leader and the same special weapons (such as automatic rifles) were always assigned to the same foxholes or positions. The other firers were assigned from right to left in the descending order of their training phase marksmanship scores.

### 5. Control of Squad Leader Variability

Squad leaders exercised administrative control over experimentation squad except during actual experimentation runs. The effects of the variability of squad leaders was controlled by using standardized, firing policies and eliminating the free play of squad leaders' opportunities.

### 6. Control for Effects of Learning

To minimize transference effects between weapons and other undesirable learning effects, each squad was trained only in the weapons of its specific weapon mix, and each squad fired each situation only once.

\* As a rifle, the M14E2 was fired in two-round bursts because the directive required that it be fired automatically. The AK47 was fired semiautomatically in Situations 1, 2, 4, 5, and in the second series for Situations 7 and 8.



Measures were taken to ensure that the experimentation subjects would not see the tactical situations before firing them. Steps were also taken to ensure that experimentation personnel had equal access to their assigned experimentation weapons during the experiment. When not in use, the experimentation weapons were held in guarded vans. During the experiment, experimentation subjects were also denied access to their TO&E weapons. However, the experimentation subjects, all soldiers of the 194th Armored Brigade had previously been trained in the M14 rifle. Some had also been trained in the M14E2 automatic rifle and M60 machinegun. This bias in favor of the US 7.62mm system was not desirable, but could not be avoided because only previously trained soldiers were available for use as experimentation subjects.

**7. Data Collection Procedures - Primary Measures**

**a. Primary Measures Data**

Most of the SAWS data were provided as output from the SDS 910 computer located on each range in the form of magnetic tapes. These data included hits, near misses, and rounds fired as a function of time.

To ensure the proper collection of valid data, a range officer, an operations analyst, (range scientist), an instrumentations maintenance officer, and a field engineer were always present at each range. In addition, test firing was also done on a regular basis for the purpose of exercising, adjusting, and calibrating the instrumentation before and during the experiment.

**b. Supplementary Data**

In addition to the data collected by instrumentation, meteorological data were taken continuously at each range. Reliability data were gathered during each squad trial. Target instrumentation calibration was checked between each squad trial and the results recorded. This included a manual count of hits on targets and near miss sensor panels, and a count of remaining ammunition.

**8. Administrative Procedures**

**a. Briefings and Debriefings**

Squads were given identical administrative and semitactical briefings on each range immediately before firing, and were debriefed for information about weapon malfunctions immediately after firing.

#### b. Safety Procedures

Because of the scale and nature of the experiment, special safety measures were necessary to reduce the possibilities of accidents, without detracting from the essential realism or validity of the experiment. Among the safety measures used were briefings on scale models and actual terrain immediately before firing with respect to safety limits, the use of specially trained controller teams at each firing line and in each moving firing situation, provision of cook-off pits for safe disposition of jammed hot weapons, and procedures for clearing hot weapons after a trial by shooting off the last round. Moving pictures were taken of controllers and firers during each squad run. These were shown later for study and correction of safety procedures and weapons malfunctions.

#### F. EXPERIMENTATION TACTICAL SITUATIONS

Experimentation was based on nine tactical squad firing situations grouped three to a range. The three situations on each range were inter-related parts of a platoon and company framework situation but fired separately for reasons of data collection and safety. The three platoon-company framework situations selected were:

- 1) Assault against defense (Range A)
- 2) Attack against delaying action (Range B)
- 3) Defense against attack (Range C)

These three platoon-company framework situations were constructed to ensure that squad situations could be related for analysis and synthesis (especially later for IRUS purposes) and to provide for the measurement of representative mechanisms and modes of fire of small unit small arms combat.

Each tactical situation constituted a model consisting of selected terrain characteristics, target array layouts, friendly firer layouts, firing distances and range-target frequencies, and timing of events representative of the situation being portrayed. (See Annex B for range sketch maps and detailed range information, to include Target System Command Program Tables.) These tactical situations, together with the effectiveness criteria, provide the fundamental basis for the analysis. The component situations and their effectiveness values can be weighted, if desired, to modify the basic model, within limits.

The target layouts were determined by examining the dispositions and dimensions given in US, Soviet, and other doctrine and, where possible, adopting dimensions that were common to the several doctrines. Detailed intervisibility and survey data were collected during layout of the ranges. As far as possible, such target behaviors as type of individual target body,

up and down movement, target exposure times, and weapon simulator cues were based on tactical realism.

The firing distances used in the tactical situations were chosen to represent the frequent and useful ranges of small arms combat with additional longer range increments added for purposes of securing a broader data base. The maximum range fired by rifle squads was 560 meters and the maximum for machineguns was 753 meters. \* Safety considerations and available terrain did not have an important effect on the firing distances selected. The percentages of targets by range for the nine tactical situations are shown below:

Range (Meters)	Percentage of Targets <sup>a</sup>	
	Rifle Squad	MG Squad
0-50	15	2
51-150	35 <sup>b</sup>	11
151-250	10	8
251-350	16	17
351-500	16	29
500-650	8	21
651-750	0	12

<sup>a</sup> Includes targets used in the night situation and targets presented more than once in a given situation

<sup>b</sup> Includes targets on assault course that ranged from 148 to 15 meters

The nine squad situations consisted of six rifle squad situations and three machinegun squad situations. Of the six rifle squad situations, two involved moving firing and one involved a night firing situation. The nine situations are tabulated below and described in the following paragraphs.

\* Preliminary experimentation on Range B (Situations 5 and 6) showed that firers could distinguish neither targets nor target array locations at these longer ranges, even when provided with more substantive auditory cues and visual cues than they would have in combat. This was true, even though individual targets had camouflaged semicircular near miss panels 4 meters in diameter behind them. The squads were therefore provided additional specific intelligence of the target array locations so that firing data could be collected at these ranges.

<u>Assault Against Defense (Range A)</u>	<u>Attack Against Delaying Action (Range B)</u>	<u>Defense Against Attack (Range C)</u>
1. Rifle squad in line assault	4. Rifle squad in approach to contact	7. Rifle squad in defense against attack
2. Rifle squad as base of fire supporting the assault	5. Rifle squad as a base of fire supporting the advance	8. Rifle squad in night defense against attack
3. Machinegun squad in fire support of the assault	6. Machinegun squad in fire support of advance*	9. Machinegun squad in defense against attack

1. Situation 1: Rifle Squad in Line Assault

Situation 1, focusing on the left target array on Range A (Figure 2-9), represented a 100-meter assault by a squad in line formation. The action lasted 2 minutes. The assaulting troops employed marching fire as they moved up the slope. Firing commenced 115 meters from the nearest target and ceased 15 meters from it. The target array being assaulted occupied a position 50 meters wide and 30 meters deep with the elevation rising 4 meters from the front to rear on the same slope as the assaulting troops. The array consisted of 17 head and shoulders targets representing concealed and partially concealed dug-in enemy soldiers, as a squad with other company elements as part of a reinforced rifle company in defense. Although irregular, the lateral interval between targets averaged 6 meters. Each target in the array had an acoustic near miss sensor, and all but three had weapons simulators.

Situation 1 evaluated rifle squad weapons mixes in marching fire against targets in foxholes at ranges of 148 to 15 meters.

2. Situation 2: Rifle Squad as a Base of Fire Supporting the Assault

This situation was also located on Range A (Figure 2-10). In addition to the target array used in the assault situation, this situation included an additional array to the right. The right array contained 13 head and shoulders targets (a squad with other company elements) occupying a position 50 meters wide and 35 meters deep with elevation rising 4 meters.

\* Machinegun squads fired this situation from two different positions. In follow-on experimentation in January, the machinegun squads fired from the same positions used by the rifle squad in Situation 5.

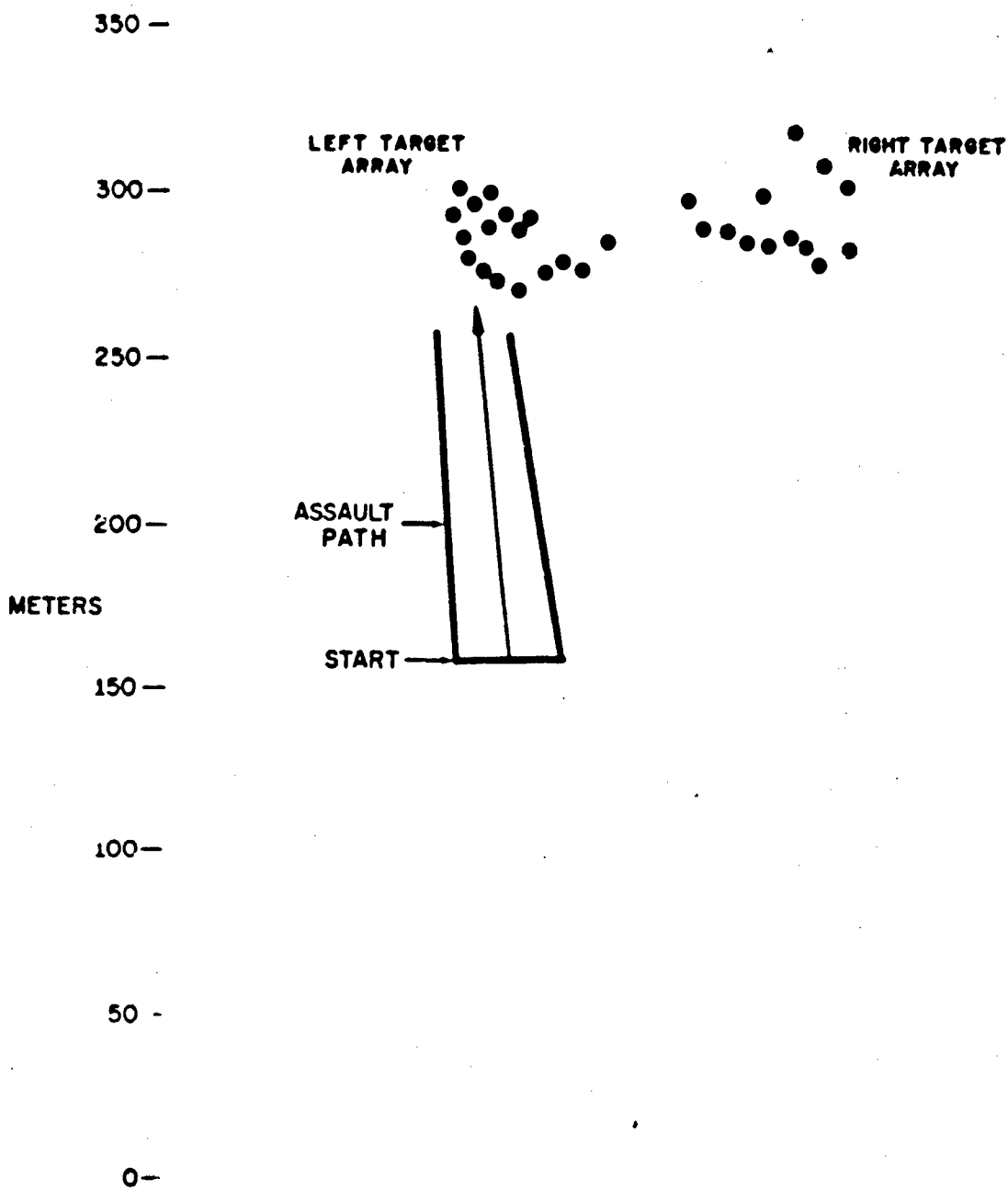

Figure 2-9  
SITUATION 1, RANGE A

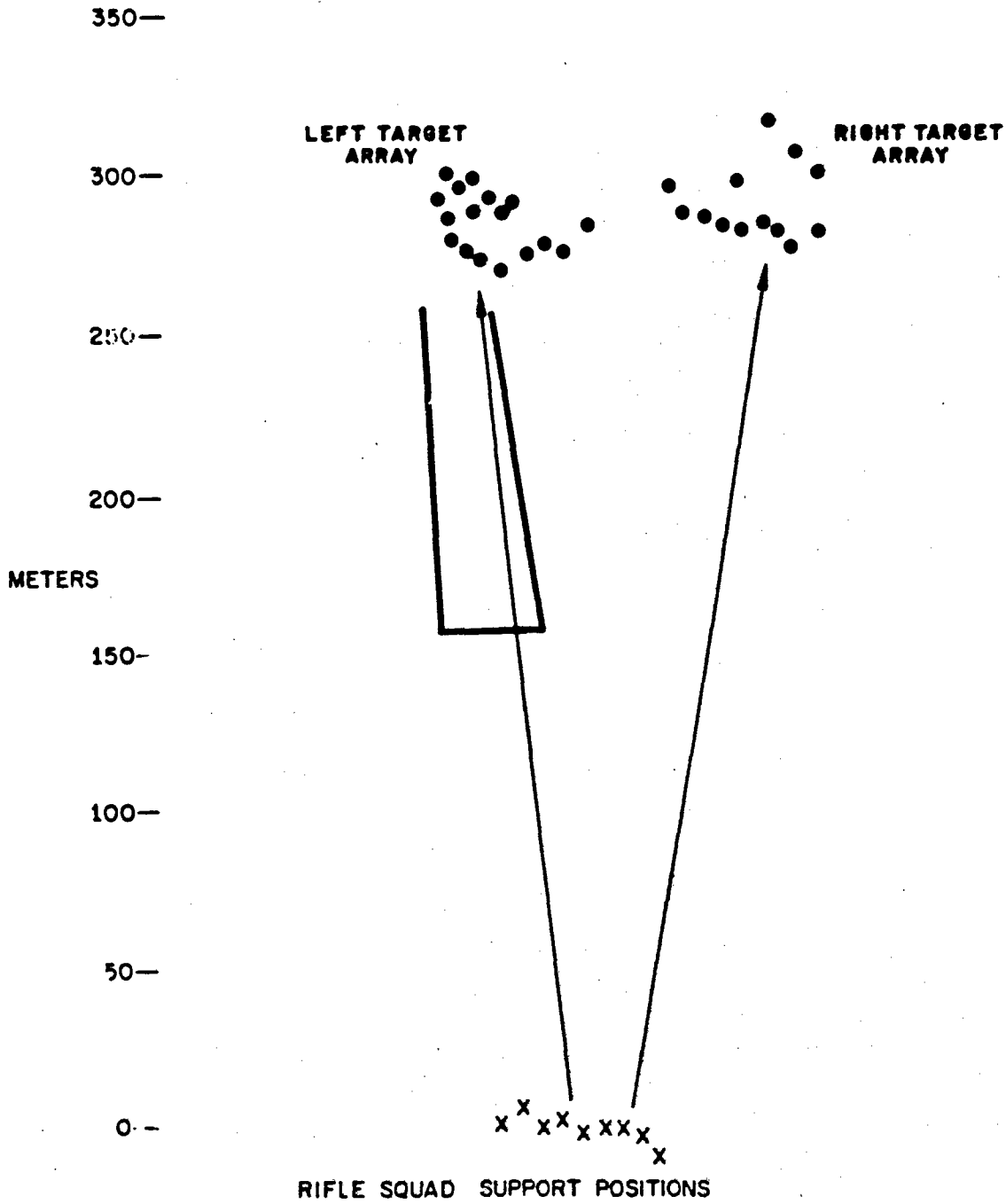

Figure 2-10  
SITUATION 2, RANGE A

from the front to the rear. All but two of the targets were equipped with weapons simulators, and all had acoustic near miss sensors.

The firers were located in nine shallow foxholes, laterally about 6 meters apart and staggered in depth along the forward edge of a ridge. The foxholes represented typical hastily prepared individual battlefield positions. The squad fired first on the left target array (the array used in Situation 1) and then shifted its fire to the right target array to simulate the shifting of fire as the assault troops closed on the enemy. The distances from the firers to the two target arrays was from 263 to 326 meters.

Situation 2 evaluated rifle squad weapon mixes firing supporting fire from hastily prepared foxholes at concealed and unconcealed targets in foxholes at a range of 263 to 326 meters.

3. Situation 3: Machinegun Squad in Fire Support of the Assault

This situation utilized the same terrain, targets and firing positions as that used by the rifle squad in Situation 2. However, this situation depicted a machinegun squad in support of a rifle squad in the assault. The two machineguns of the squad were positioned 25 meters apart (Figure 2-11).

4. Situation 4: Rifle Squad in Approach to Contact

This situation, located on Range B (Figure 2-12), included 12 events and employed 40 targets (four head and shoulders, 32 kneeling and four standing). The 12 events were laid out along a course over which the rifle squad advanced in a sweep formation as a line of skirmishers. The events represented action by snipers, scattered enemy security elements, and an ambush. The overall course was 430 meters long (Figure 2-13).

As the squad approached an event at a location identical for each squad, the targets--30 equipped with weapons simulators--were actuated and the men stopped and fired. The firing distances for the events varied from 19 to 180 meters. Target exposure times varied from 2 to 10 seconds. The targets were not equipped with near miss sensors.

The approach to contact situation evaluated the rifle squad mixes in standing quickfire at briefly exposed visible targets. This situation, in which firers were time stressed, was designed especially to evaluate the pointing characteristics of small arms.

5. Situation 5: Rifle Squad as a Base of Fire Supporting the Advance

The rifle squad occupied unprepared prone firing positions averaging 6 meters lateral distance apart and staggered 48 meters along the forward edge of a ridge (Figure 2-14). Squads representing fire support of an advancing rifle squad (Situation 4) delivered fire on two target arrays. The

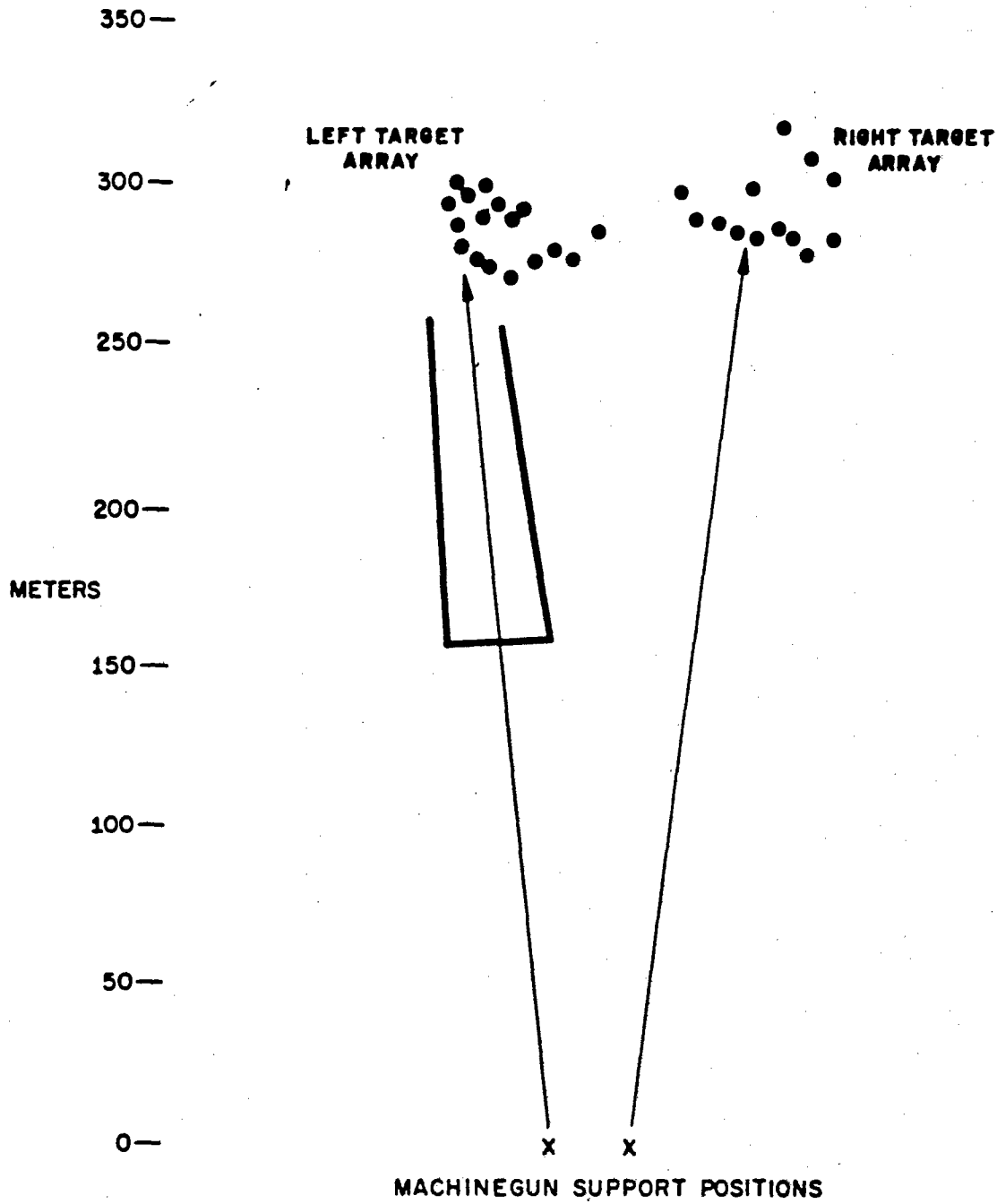

Figure 2-11  
SITUATION 3, RANGE A



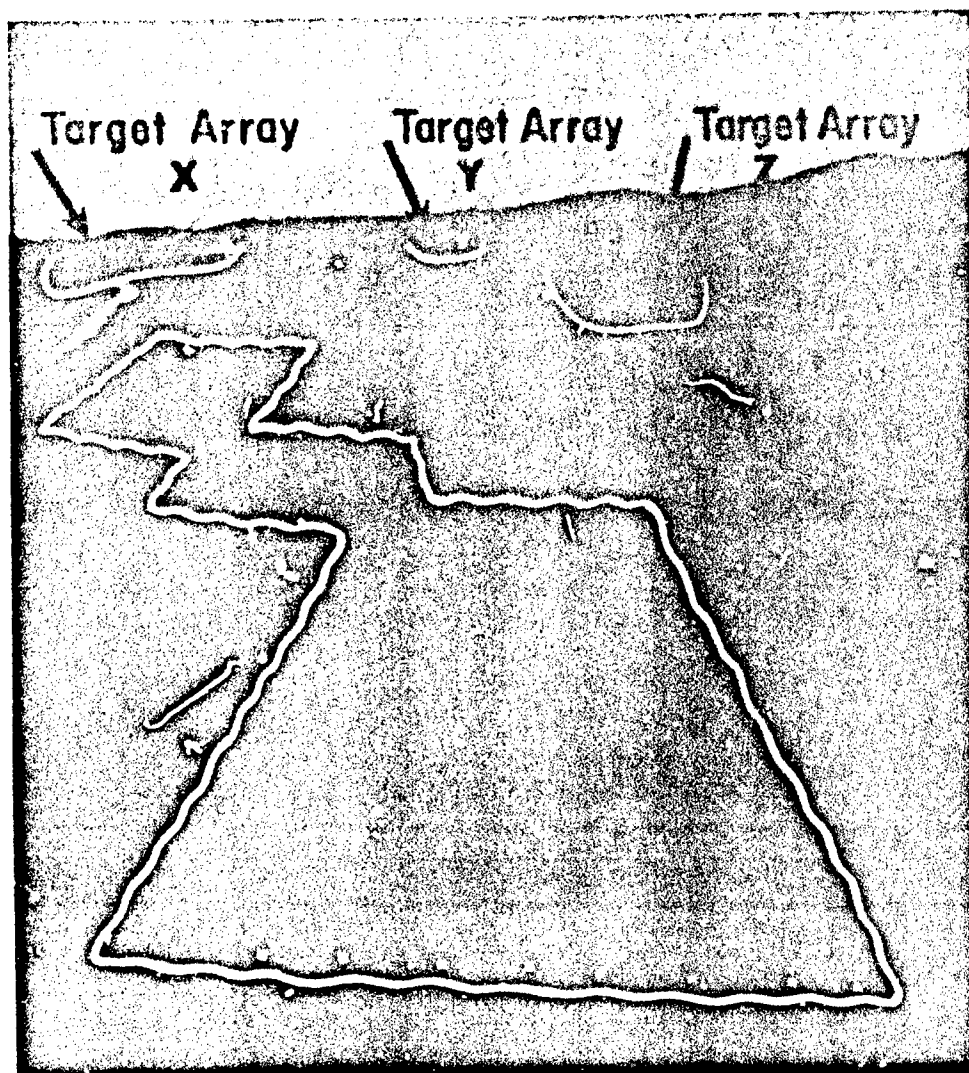

Figure 2-12  
SITUATION 4, APPROACH TO CONTACT, RANGE B

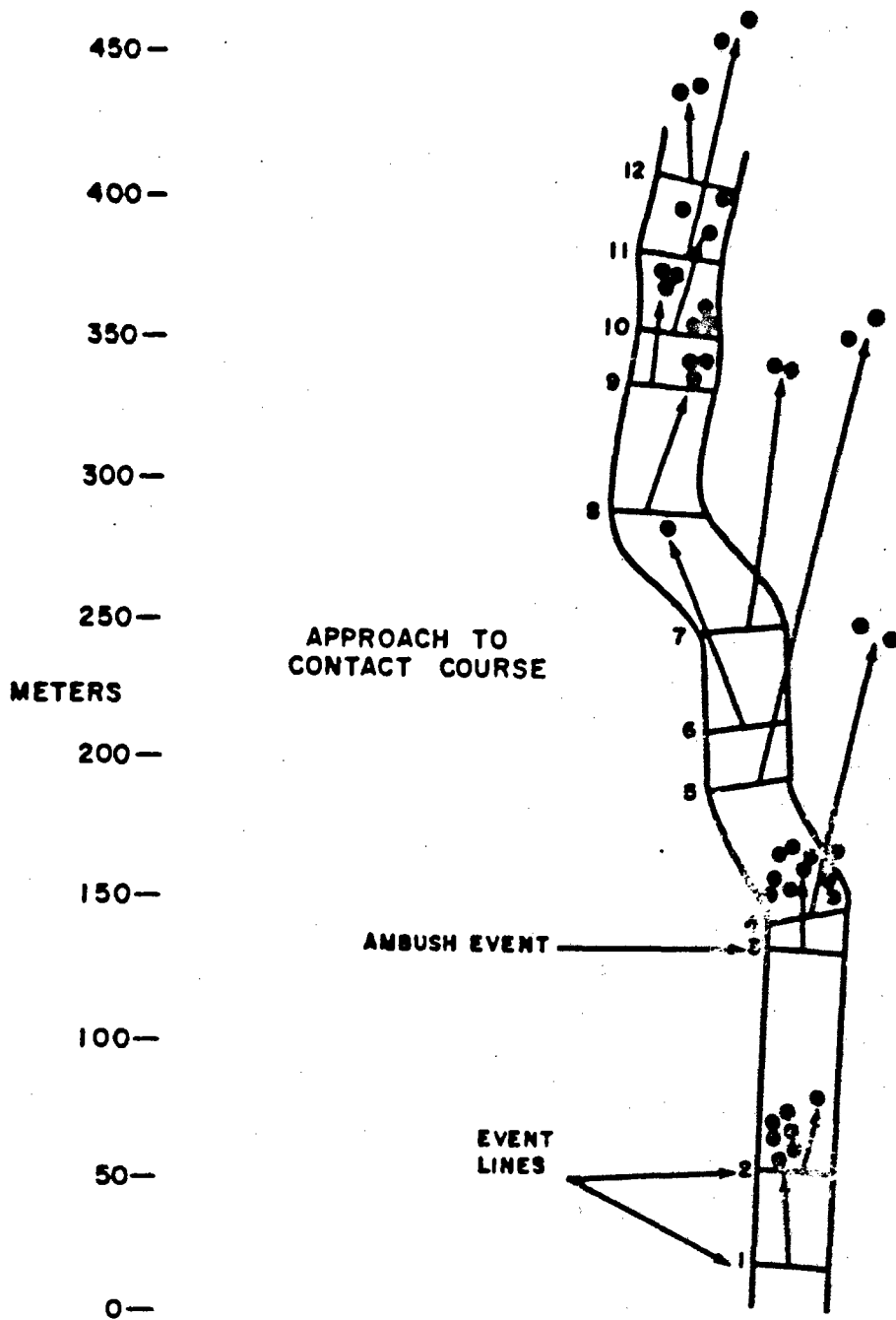

Figure 2-13  
SITUATION 4, RANGE B

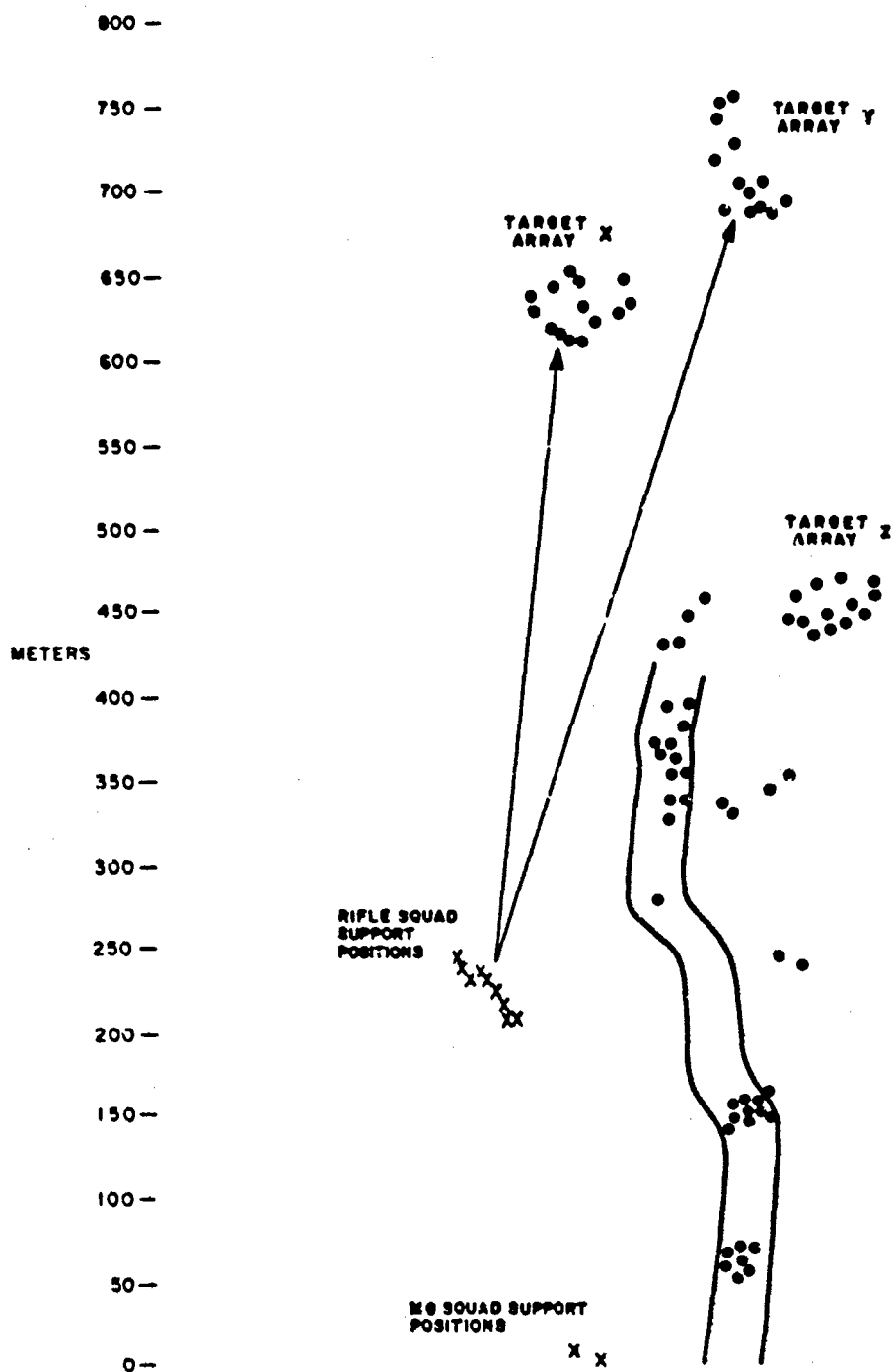

Figure 2-14  
SITUATION 5, RANGE B

arrays represented partially dug-in enemy in a delaying position. Target Array X contained 14 targets (five head and shoulders and nine kneeling) occupying an area 60 meters wide and 42 meters deep, with an elevation from front to rear targets of about 7 meters. Its range from the firers was 379 to 445 meters. Six of the 14 target elements in this array had weapon simulators. The more distant Target Array Y with three head and shoulders, three kneeling and seven standing targets, was 477 to 560 meters from the firers, occupying an area 45 meters wide and 62 meters deep with elevations rising about 7 meters. Six of the 13 targets had weapon simulators. The targets of both arrays were equipped with near miss sensors. The rifle squad initially fired on Target Array X and then shifted its fire to Array Y, firing 2 minutes on each array.

Situation 5 evaluated rifle squad weapons mixes delivering long range supporting fire from prone positions against concealed partially dug-in targets at ranges of 379 to 560 meters.

6. Situation 6: Machinegun Squad in Fire Support of Advance

This situation was also on Range B (Figure 2-15). Machineguns of the machinegun squad weapon mixes occupied positions about 12 meters apart along the forward edge of a knoll 240 meters to the rear of the rifle squad position of Situation 5. In addition to firing upon Target Arrays X and Y discussed in Situation 5, Target Array Z was also fired upon and contained 13 targets occupying an area 52 meters wide and 32 meters deep, with an elevation from front to rear targets of about 7 meters. Like Arrays X and Y, all targets of this array had near miss sensors and six were equipped with weapons simulators. Target Array Z was located to the right of Target Arrays X and Y at a shorter range and contained five head and shoulders and eight kneeling targets. Ranges to the three target arrays from the machinegun squad position were 603 to 646 meters for Array X, 690 to 753 meters for Array Y, and 446 to 488 meters for Array Z. Firing time was 2 minutes on each array.

Situation 6 evaluated the machinegun squad weapon mixes in firing long range supporting fire from prone positions at concealed and partially concealed, partially dug-in targets at ranges from 446 to 753 meters. It was designed to evaluate long-range fire effectiveness of the weapons under tactical conditions.

7. Situation 7: Rifle Squad in Defense Against Attack

This situation took place on Range C (Figure 2-16). There were 50 targets, four head and shoulders, 17 kneeling and 29 standing, located and programmed to raise and lower to represent an attack becoming an assault. Some of the targets appeared more than once. The attack began at a range of 344 meters and culminated with targets appearing in an

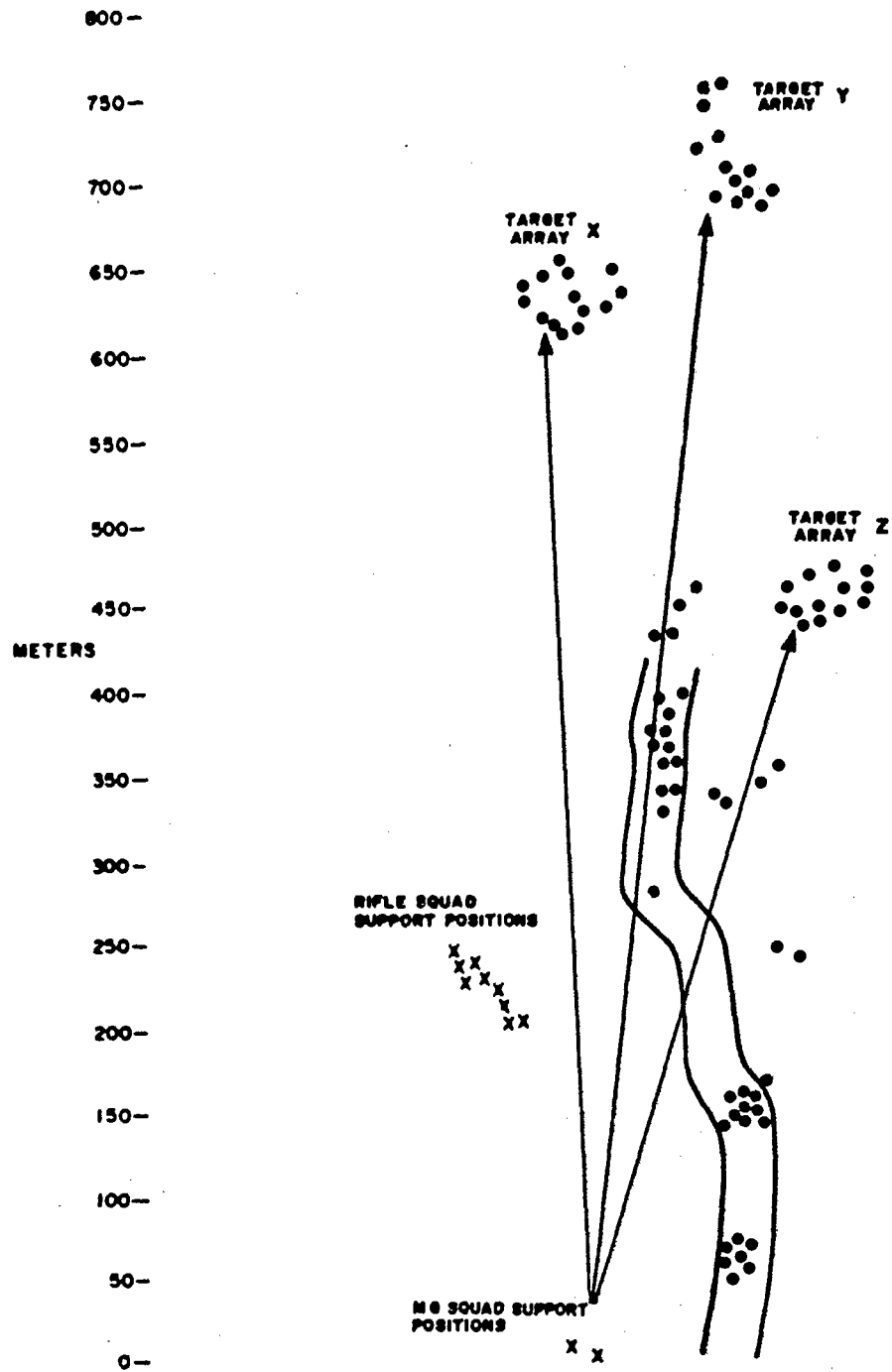

Figure 2-15  
SITUATION 6, RANGE B

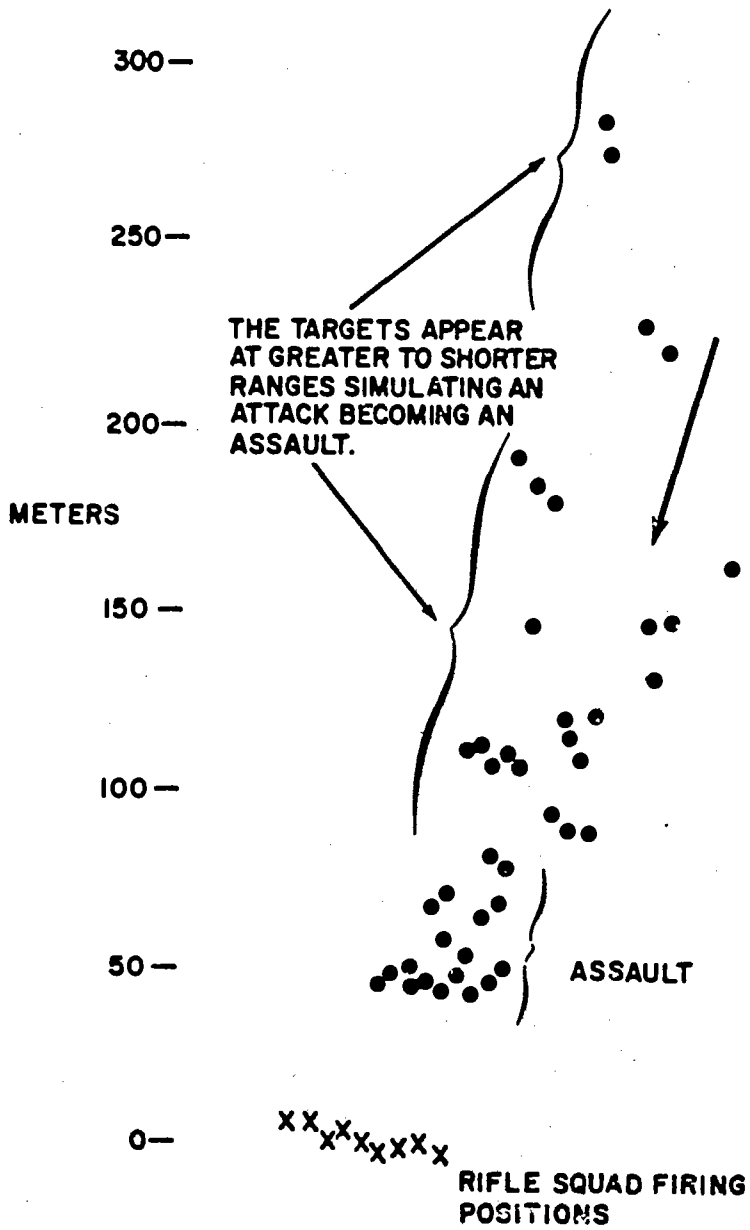

Figure 2-16  
SITUATION 7, RANGE C

assault formation 43 meters from the firing positions. Thirty of the 50 targets had weapon simulators; none had near miss sensors. The defending squad occupied hastily prepared foxholes averaging 6 meters lateral distance apart.

Situation 7 (daylight defense) evaluated rifle squad weapons mixes in firing from hastily prepared foxholes at visible targets advancing from 344 to 43 meters.

8. Situation 8: Rifle Squad in Night Defense Against Attack

The night situation was also located on Range C and was similar to Situation 7. However, the scenario was slightly shorter. Thirty-two of the 50 targets used in Situation 7 were utilized; 22 targets were equipped with weapons simulators. Some of the targets appeared more than once. There were three head and shoulders, nine kneeling and 20 standing targets; they were located and programmed to raise and lower to represent an attack becoming an assault. The attack began at a range of 234 meters and culminated with targets appearing in an assault formation 43 meters from the firing position (Figure 2-17). Simulator flash and sound were the main cues for firers in this night situation.

Situation 8 evaluated rifle squad weapons mixes firing night defense from hastily prepared foxholes at target flash and sound cues of targets "advancing" from 234 to 43 meters.

9. Situation 9: Machinegun Squad in Defense Against Attack

This situation utilized the same terrain, targets and firing positions as that used by the rifle squad in day defense (Situation 7). However, in this situation the machineguns occupied selected foxholes of the position that had been occupied by the rifle squad (Figure 2-18).

This situation evaluated the machinegun squad weapon mixes firing from hastily prepared foxholes at visible targets advancing from 344 to 43 meters.

10. Summary of Tactical Situations

The nine tactical situations, together with the effectiveness criteria discussed in paragraph G of this section, provide the model for the experiment and analysis of squad-level small arms fire effectiveness. The model can be adjusted (within limits) by weighting the situations and the effectiveness measures within a situation. The logic underlying the experimental design, terrain selection, tactical target arrays, instrumentation, and programming of events in these tactical situations was to present squads armed with different weapons and weapon mixes with situations

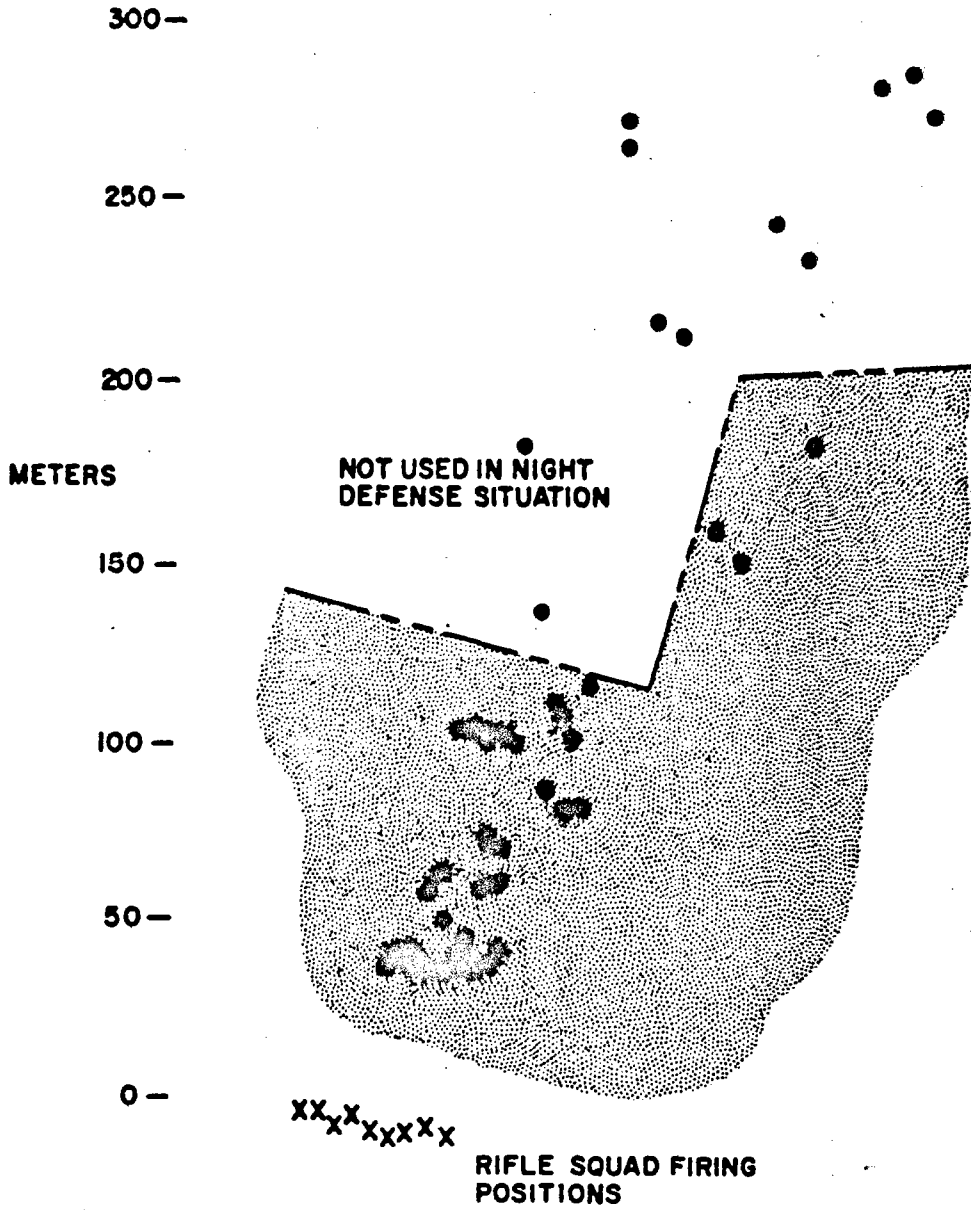

Figure 2-17  
SITUATION 8, RANGE C



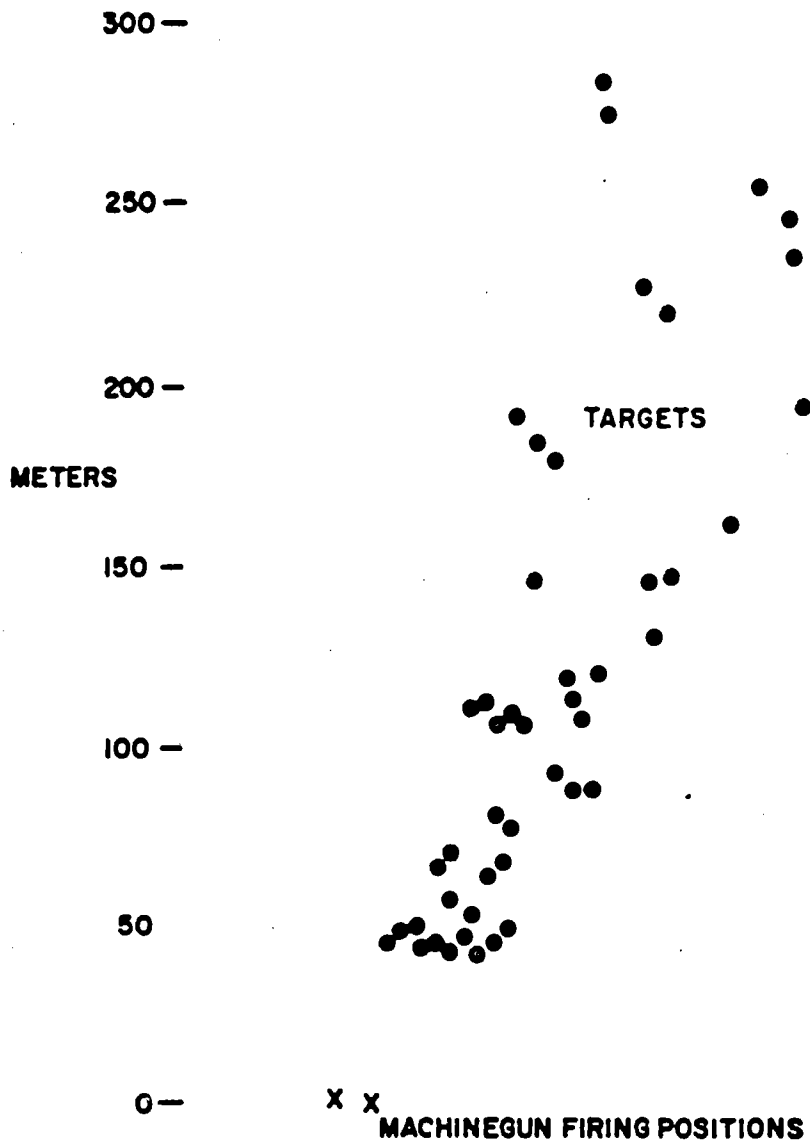

Figure 2-18  
SITUATION 9, RANGE C

that would impose on the man-weapon systems, conditions, interactions, and modes of fire reasonably representative of combat. Target acquisition was included as an integrated part of the effectiveness evaluation of the man-weapon systems. Firers were subjected to the stress and uncertainties of intervisibility problems and the knowledge that, if and when revealed, targets would be fleeting or exposed for unpredictable periods. However, stress was not otherwise included.

The final elements of the tactical situations were the operational policies of friendly elements--the basic loads of ammunition, ammunition mixes, burst lengths, and firing policies used with each tactical situation. These are discussed in paragraph E of this section and presented in tabular form in Annex A.

#### G. EFFECTIVENESS MEASURES (EVALUATION CRITERIA)

This subsection describes the effectiveness measures used in evaluating and ranking the squad weapon mixes. It consists of three paragraphs: Paragraph 1, discussing the qualitative effectiveness concept from which the measures are derived; Paragraph 2, presenting the effectiveness measures themselves; and Paragraph 3, discussing other effectiveness qualities.

##### 1. Effectiveness Concept

The effectiveness measures selected for use in the experiment were derived from the following qualitative effectiveness concept, which also served to guide their use. This concept is necessarily judgmental as a hypothesis, as must be the starting point and foundation of any effectiveness criteria. It also depends particularly on informed military judgment or military experience, since system evaluation implies that the things measured must be valuable qualities of the systems, in the context and environment of their use.

The purpose of the infantry fire fight is to gain fire superiority. Other factors being equal, small arms fire superiority prevents the enemy's fire or movement, permitting mission accomplishment.

Achievement of fire superiority requires two elements: 1) attaining a greater magnitude of target effects than the enemy, as a function of time, and 2) sustaining this level of target effects longer than the enemy can sustain his level of target effects, and long enough to accomplish the mission. These two elements are referred to here as target effects and sustainability.

Neither element is meaningful unless related to time. The two-sided nature of the fire fight places a premium on achieving results (target

effects) more quickly than the opponent can achieve them. The concept of sustainability also implies time.

**a. Target Effects**

To understand target effects, the nature of the target and the friendly firers must be considered.

In combat, the infantry small arms target is normally a group target--an array of individual targets dispersed in width, depth, and usually height. The target arrays frequently present a pattern in shape, structure, and size. Normally most of the targets in the array are concealed or partially concealed, and firing on the array is often directed at a combination of cues--such as terrain form (for example, the military crest of a hill), and target weapon signatures--and movement, rather than at fully visible individual human targets. When targets are not concealed, they are usually very near or exposed only briefly.

Friendly firers are also a group (in this experiment, a squad) and behave in a group context. The individual man-weapon interacts with others in the group at the firing position (for example, muzzle blast and dust), in feedback of target intelligence (for example, incidental observation of another's tracer or of the ground strike of another's bullets), and in effects on the enemy target array.

Thus, the fire effects produced have characteristics that may differ significantly from those of single weapons fired at single visible targets. Within this context of group firers and group targets, the two principal target effects produced by small arms weapons are hits and near misses, and they combine in their effects on a target array.

**(1) Target Hits**

The effects of hits on individual targets of an array are highly sensitive to the timing of the hits and to the damage they inflict on the array. First hits on individual targets are more important than subsequent hits on the same target. In combat the target may drop and cease to be a target after the first hit and, in any event, there is little utility in killing a target more than once.

**(2) Near Misses**

If near enough and in sufficient volume, near misses cause the target soldier to seek cover and thereby take his weapon out of action or prevent his movement. Suppressive effects of small arms, particularly automatic or rapidly firing weapons, may have a greater effect on the outcome of infantry actions than the lethal effects of hits. Near misses,

however, will not produce suppression if the weapons and firing doctrine cannot produce casualties. The nearness of a miss as a function of time is only one factor contributing to suppression, but it is a necessary condition if a weapon is to have any suppressive effect. For purposes of ranking weapons, near misses can be dealt with by recording them as a function of time, without having to define the quantitative level of near misses that constitutes suppression.

Near miss data also provides information on distribution of fire. Information on the distribution of fire greatly extends our knowledge of the behavior of weapon systems, and firing doctrine.

**b. Sustainability**

**Sustainability**—the other element needed to achieve fire superiority—is the length of time a weapon can fire at the ammunition consumption rate required to achieve a level of target effects with the amount of ammunition that the weapon system affords within specified weight limits. It is not used in the sense of reliability or durability.

The sustainability element of fire superiority then is the measure of how long the fire (level of target effects) can be kept up. With respect to a single small arms weapon, it is a function of three factors: 1) the weight rate of ammunition consumption in achieving a level of target effects, 2) the system weight of the weapon, and 3) the weight limitation on the weapon system portion of the soldier's combat load carrying capacity. Sustainability in a small arms system is highly sensitive to system weight, since the infantryman is severely weight-limited. System weight limits used for the experiment are discussed on page 2-8.

**c. Interrelationships**

Hits cannot be related to near misses in an absolute sense because of the impossibility of defining the level of near misses constituting suppression for a given situation. However, the relative value of hits or near misses as a measure can be obvious for a given situation. There are also the possibilities of examining near misses parametrically.

The relationship between sustainability and target effects is clearer. A gain in sustainability potential can be taken out at the unit commander's option as 1) within limits, a higher level of effects, 2) greater sustainability at an equal level of effects, 3) reduced soldier's load at the same level of effects (increase in mobility), or 4) some combination of these.

**2. Measures of Effectiveness**

Based on the qualitative effectiveness concept, three primary measures of effectiveness were selected: cumulative target exposure

time, near misses, and percentage of ammunition remaining (sustainability). In addition, two collateral measures were selected: targets hit and total hits.

**a. Primary Measures of Effectiveness**

**(1) Cumulative Exposure Time**

Each target of an array was programmed to be exposed for a predetermined period that was identical for each squad in a given tactical situation. In the day defense situation, for example, the sum of the programmed exposure times for all the targets of the entire array of 50 targets was 15.976 minutes. However, individual targets fell when hit, reducing their exposure time and thus the total or cumulative exposure time of the array. For programmed total exposure times for each tactical situation, see Appendix 4 to Annex B. In the hypothetical example shown in Table 2-8 there are ten targets in an array with a programmed total exposure time of 12.400 minutes. The sequence of ten targets shows that some targets were raised earlier and stayed up longer than others. The total target exposure time for targets attacked by Squad A is therefore shortened from the programmed 12.400 minutes to 5.700 minutes. This 5.700 minutes total exposure time is the cumulative exposure time (CET) for Squad A. Similarly, Squad B achieves a CET of 8.800 minutes. To the extent that a squad rapidly acquires and hits targets the CET will be less. A lower CET indicates that friendly forces in a fire fight are subjected to fewer man-minutes of return fire from the target array and consequently suffer fewer casualties and other effects. Therefore, the concept takes considerable account of vulnerability.

CET of the target system is a primary measure of fire effectiveness. It reflects both the number of targets in a group that were hit and the timeliness in which they are hit.

**(2) Near Misses**

Near miss data were obtained in three of the six rifle squad situations and two of the three machinegun squad situations. \* Near misses passing within a 2 meter hemisphere about the target were sensed by an acoustic sensor; where camouflaged panel sensors were used (Situations 5 and 6), near misses were sensed by a 2 meter semicircular panel centered behind the target body. In both cases near misses were recorded as a function of time.

\* The rifle squad situations were the assault (Situation 1), base of fire in support of the assault (Situation 2), and base of fire in support of the attack against delaying action (Situation 5). The two machinegun squad situations were those in support of the rifle squad in the assault (Situation 3) and in fire support of the advance (Situation 6).

**Table 2-8  
HYPOTHETICAL EXAMPLE OF  
CUMULATIVE EXPOSURE TIME (CET)**

Target Number	Target Sequence (minutes)		Individual Target Exposure Time (minutes)		
	Programmed Up Time	Programmed Down Time	Programmed <sup>A</sup> Exposure Time	Squad A <sup>B</sup>	Squad B <sup>B</sup>
1	0	1.700	1.700	.500	.300
2	.500	2.000	1.500	.500	1.200
3	.600	2.200	1.600	.700	1.500
4	1.000	2.500	1.500	.600	1.500 <sup>C</sup>
5	1.200	2.000	.800	.800 <sup>C</sup>	.800 <sup>C</sup>
6	1.800	3.000	1.200	.200	1.100
7	2.200	4.000	1.800	1.000	1.000
8	3.500	4.500	1.000	.600	.500
9	4.000	4.300	.300	.300 <sup>C</sup>	.300 <sup>C</sup>
10	4.500	5.500	1.000	.500	.600
Programmed Total Exposure Time (minutes)			12.400		
Cumulative Exposure Time (minutes)				5.700	8.800

<sup>A</sup> Programmed down time minus programmed up time

<sup>B</sup> Hit time minus programmed up time (targets went down when hit)

<sup>C</sup> Target not hit

The measure of near misses used in the present report is total near misses. Near misses are a primary measure because of the importance of suppressive fire effects. However, because of instrumentation procurement limitations near misses could not be measured in all tactical situations.

### (3) Sustainability

The primary determinant of weapon sustainability (in the sense that it is used here) is the length of time that available ammunition can sustain an attained level of effects. The measure of sustainability used here is the percentage of ammunition remaining for a squad mix when the squad weapon system weight constraint (starting system weight), tactical situation, and record run time are held constant for all squad mixes. In Figure 2-19, for example, if Squad Weapon Mix B used 50 percent of its ammunition load to attain a given level of effects, it would have only half the sustainability (ability to maintain the same level of effects longer) of Squad Weapon Mix A that attained the same level of effects with an expenditure of only 25 percent of its ammunition.

#### b. Collateral Measures

Collateral measures, as defined here, are lesser included functions of primary measures and therefore are subordinate to primary measures. They are performance measures, rather than effectiveness measures. However, the collateral measures of the number of targets hit and total number of hits provide some limited insights into weapon system behavior and sometimes facilitate interpretation of the primary measures.

##### (1) Targets Hit

This measure indicates the number of targets hit in a given target system, but gives no indication of the amount of time required to secure the hits. When related to total targets, it provides a measure of fire distribution and some insight into the cumulative exposure time measure. If the same number of targets in an array are hit, but at different times, the cumulative exposure time will be different.

##### (2) Total Hits

This measure takes into account multiple hits on targets. Since targets in this experiment fell on receiving a first hit, multiple hits could occur, as in combat, only because of rapid fire from a single weapon or because two or more firers acquired and hit a target almost simultaneously. The total hit measure has collateral worth as an effectiveness measure, especially if two systems rank equally in other respects.

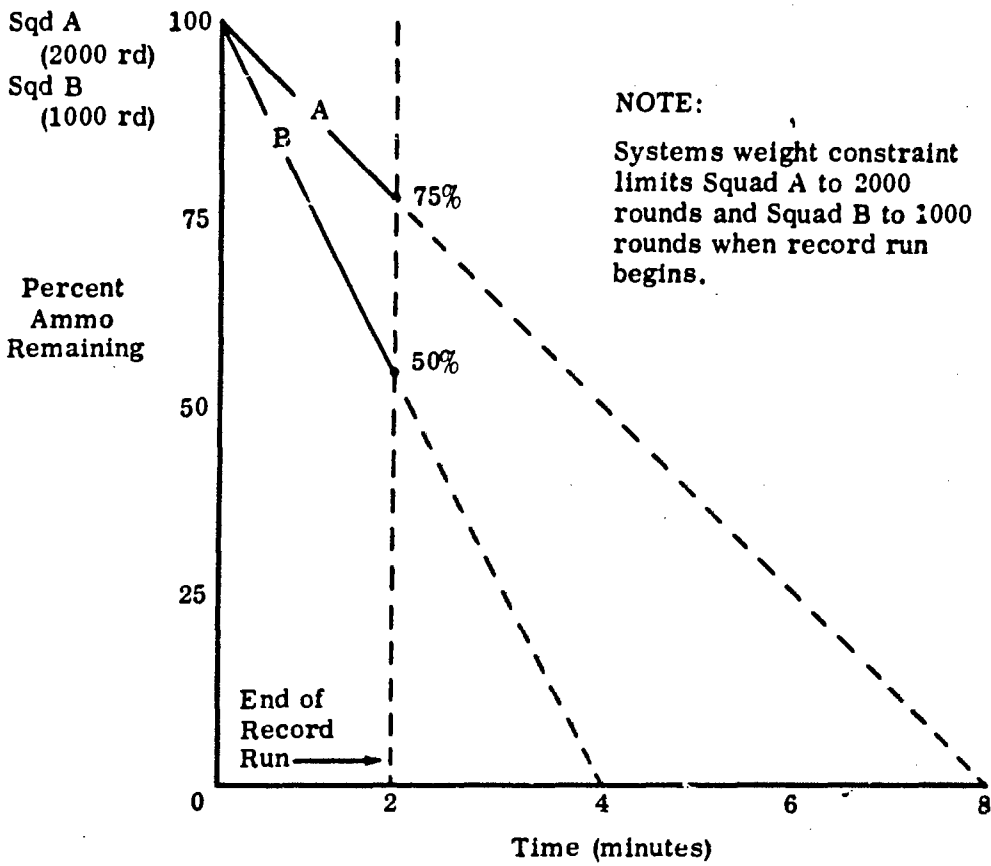

Figure 2-19  
EXAMPLE OF SUSTAINABILITY



### (3) Correlations

A correlation analysis was run on measures of effectiveness, both primary and collateral, to determine the extent of the relationships of the various measures to each other, and to gain further understanding of the nature of these relationships. Tables describing these relationships are presented in Annex D.

#### 3. Effectiveness Qualities - Combat Effectiveness Components

Combat effectiveness components important to the evaluation of small arms weapon systems include the following:

- a) Fire Effectiveness
- b) Weight reduction
- c) Tactical versatility
- d) Reliability
- e) Training
- f) Collateral applications

They are discussed and related to the output of the SAWS field experiment, in turn.

##### a. Fire Effectiveness

USACDCEC's primary contribution is in this area. This report provides the fire effectiveness results, and relates lethality to the effectiveness results.

##### b. Weight Reduction (Mobility)

Weight reduction results--rankings of squad weapon mixes according to the amount of weight that can be eliminated from the soldier's or squad's combat load if a sustainability advantage is taken out (even partly) in weight reduction--can be computed from the weights of the weapon systems and the sustainability results presented in Section VI. The shorter, lighter weapons were naturally more easily carried and therefore increased the soldier's mobility.

##### c. Tactical Versatility

This quality includes: 1) the relative capability of candidate weapons to perform the functions of the rifle, carbine, submachinegun,

automatic rifle, antitank grenade launcher, and M79 grenade launcher with the fewest number of weapon types; and 2) the relative suitability of the weapons for use by airborne, airmobile, mechanized and amphibious forces. The USACDCEC SAWS experiment implicitly covers some aspects of tactical versatility, particularly in the area of dismounted rifle and machinegun squads. For example, rifles, automatic rifles and machineguns were all fired in the automatic rifle role.

**d. Reliability**

This quality includes reliability, durability, ruggedness, and performance under extreme conditions. The experiment provided data on reliability-durability and operation in the field, including sandy conditions. Reliability results are presented in Section V:

**e. Training**

Training effectiveness for the experiment is discussed in paragraph D-4 of this section and in Section IV.

**f. Collateral Applications**

This includes such matters as suitability for use in the Military Assistance Program (MAP). The distinction between this quality and tactical versatility is one of degree. Insight into these areas can be derived from USACDCEC fire effectiveness, weight reduction, and reliability data. USACDCEC's answers to the essential elements of analysis (EEA) provided to USACDC by separate letter further relate USACDCEC SAWS data and results to some of these broader questions of collateral applications.\*

---

\* Letter, CDEC-TB, HQ USACDCEC, 1 April 1966, Subject: Essential Elements of Analysis (EEA), Small Arms Weapons System (SAWS) Program.

**BLANK PAGE**

### SECTION III

#### METHODOLOGY FOR THE PRESENTATION OF RESULTS

##### A. ORGANIZATION OF RESULTS

The data and results from which the USACDCEC SAWS conclusions were evolved are presented in Sections IV through VIII. Each Section deals with a particular type of experiment or data base.

Section IV deals with training implications.

Section V presents the results of the USACDCEC analysis of the materiel reliability data collected during the experimentation.

Section VI details the results of fire effectiveness experimentation designed to discriminate among squads armed with different weapon mixes. That section is divided into three parts. Part A, dealing with the rifle squad mixes for which experimentation was originally planned and mixes provided for either in the USACDCEC outline plan or in a subsequent directive from USACDC Headquarters; Part B, covering follow-on rifle squad experimentation and presenting results of an investigation into the feasibility of adopting a rifle squad equipped only with Colt automatic rifles, or with a combination of Colt rifles and Stoner machineguns; Part C, discussing the comparative machinegun experiment.

Section VIII is a brief note discussing the relationship between current lethality data and the USACDCEC SAWS results and conclusions.

Section IX presents USACDCEC SAWS conclusions.

##### B. DATA PRESENTATION FORMAT

The numerical results for situations in most cases are presented within the framework of a single large consolidated table (comprised of subtables) and a set of graphs. Tables and graphs for each situation are accompanied by brief descriptions of the situations, summaries of the respective tables and graphs, a list of standard scores, and a summary analysis.

Three types of data are presented: descriptive statistical performance measures; probability measures, and graphic presentations of the data as a function of time and range, where applicable.

Performance measures, (the effectiveness and collateral measures discussed in Section II, are used to rank the squad mixes. Probability measures provide the means of determining the extent to which experimentally observed differences are chance results caused by variations in the experiment.

If observed differences have a low probability of occurring because of experimental variations, it may be considered with a high degree of confidence that the differences in performance measures are caused by system differences. Performance measures and their ranking should not be used without reference to statistical probability measures.

Sections IV, V, and VII do not deal directly with fire effectiveness results. These data are presented primarily in a descriptive narrative format.

For purposes of brevity and clarity, it was necessary to assign a two-letter code designation to each weapon mix. The weapon mixes are referred to by this code in most of the tables and graphs of the report. The key is presented below.

- UA - 9 M14 Rifles
- UB - 7 M14 Rifles and 2 M14E2 ARs
- UC - 5 M14 Rifles and 2 M60 MGs
- UD - 9 M14E2 Rifles
  
- CA - 9 M16E1 Rifles
- CB - 7 M16E1 Rifles and 2 Colt ARs
  
- SA - 9 Stoner Rifles
- SB - 7 Stoner Rifles and 2 Stoner ARs
- SC - 7 Stoner Rifles and 2 Stoner MGs
  
- RA - 9 AK47 Rifles
- RC - 7 AK47 Rifles and 2 RPD MGs
  
- CX - 9 M16E1 Rifles (Same mix as CA, but used in follow-on experimentation as a control mix)
- CY - 9 Colt ARs
  
- MB - 7 M16E1 Rifles and 2 Colt ARs  
(Same mix as CB, but used in follow-on experimentation as a control mix)
- MC - 7 M16E1 Rifles and 2 Stoner MGs

## C. EXPLANATION AND DESCRIPTION OF DATA

### 1. Performance and Statistical Probability Measures

A difference will usually emerge if the characteristics of two mixes are measured. For example, one mix may measure 22 and another 20. A question then arises: does the observed difference represent a real difference in mixes, or is it due either to chance elements that affected the experiment or due to sampling variations?

There is no absolute yes or no answer, but statistical techniques can provide the probability that an observed difference is due to chance variation. This is the likelihood that a wrong decision would be made by rejecting (on the basis of the experimental observations) the hypothesis that there is no real difference in the systems.

In the example where one mix performance measured 20 and another 22, the probability can be estimated that if the experiment were repeated many times, a difference of two or more would occur from chance. Such a probability might turn out to be, for example, .03. If the mix that measured 22 were selected on this basis, there is a probability of .03 that the selection was wrong--wrong in the sense that there may be no differences in the system.

If a probability level of .20 is selected for rejecting the hypothesis of no real differences, there is a high risk in concluding that the observed performance difference reflects a real difference in mixes.

It is also possible to make another kind of erroneous decision, that of accepting the hypothesis that differences in a performance measure are due to chance when in fact there is a real difference in the performance of the mixes. The ability of a statistical test to indicate real difference in performance measures depends on the magnitude of the real difference and on the size of samples. These two factors influence the probability of observed differences in the performance measure and the magnitude of observed differences that will lead to rejection of the null hypothesis that there are no system differences. In this experiment, the sample sizes were as large as possible within the practical limit of the experiment, so that real differences in performance measures would have the greatest likelihood of being detected. Some real differences undoubtedly will remain undetected, but the rejection probability should be valid for any differences that are labeled significant.

The appropriate probability level for rejection is a matter of judgment involving a certain amount of risk. A low level for rejecting the hypothesis that the observed difference is real reduces the risk of erroneously concluding that there is a real difference when there is not, but it increases the risk of rejecting a mix that might in fact be superior in the quality measures.

To facilitate this judgment process, the report, for the majority of the results, presents a subtable for each measure presented in a situation, showing the probabilities that can be attached to experimentally observed differences in each possible pair of squad mixes. The probabilities are presented in numbers up to .40. These tables might indicate, for example, that the chance that the observed difference between mixes A and B could be equal to or greater than the measured amount is .08. As these probability figures more closely approach the value of .50, the risk that the experimentally measured differences were caused by chance factors becomes greater.\*

Presented on the following pages are Subtables A and H from the table for Situation 2, which treats cumulative exposure time (CET).

Subtable A shows the mean (average) raw CET score in minutes of total target exposure time of each squad mix, and the standard deviation (SD) of each mix's score. Finally, it shows the mean standard score ( $z'$ ). (The standard score concept will be discussed further below.) At the bottom of Subtable A is shown the mean (average) of the squad mix mean scores ( $\bar{X}$ ), and its standard deviation (SD).

Each measure for the rifle squad experiment is also illustrated in a series of bar graphs located on the same foldout page as the numerical data and probability table presentations. The bar graphs portray the mean (average) scores of all mixes, the range of all squad scores, and the ranges of the six squad scores comprising the highest and lowest scoring mix for each measure for each situation. In addition to these bar graphs, histograms (a type of bar-graph representation) and graphical representations of distributions of measures as a function of time and range are presented for some experimentation situations. These two methods of data presentations are explained in paragraphs C-6 and C-7 of this section.

The bar graph for Situation 2 (Rifle Squad As A Base of Fire Supporting the Assault) should be referred to for comparison with Subtable A being discussed here. The first block of the graph shows CETs that were also treated in the first table of statistical figures, Subtable A. The first bar on the left shows the mean scores corresponding to mean CETs in Subtable A; the second bar shows the range of all squad scores regardless of

---

\* It should be noted that these probabilities are not offered as precise confidence levels for formal tests of null hypotheses. Such a test would require either an a priori statement of the particular pair of mean values to be compared, or a composite analysis of variance with the pairwise test being used to identify significant analysis of variance contributions. In the absence of a significant F test these probabilities should only be considered to provide a rough indication of the relative importance of the magnitude of the differences tested.

Subtable A—CUMULATIVE EXPOSURE TIMES

Mix	$\bar{X}$ CET	SD	Standard Scores z'
UA	77.5	2.3	77.1
CA	78.2	10.0	71.2
UD	78.6	8.3	68.3
UB	80.0	6.6	59.0
SC	80.4	9.4	53.8
SB	81.0	10.1	48.9
SA	82.0	9.1	41.4
CB	82.1	4.6	40.4
UC	84.2	7.2	23.6
RA	85.1	10.9	16.6
$\bar{X}$	80.9		
SD	2.52		

Subtable H—CUMULATIVE EXPOSURE TIME p FACTORS

	UA	CA	UD	UB	SC	SB	SA	CB	UC	RA
UA		>.40	.38	.22	.24	.21	.14	.03	.03	.07
CA			>.40	.38	.35	.32	.26	.20	.13	.15
UD				>.40	.37	.33	.26	.19	.12	.15
UB					>.40	>.40	.32	.24	.15	.17
SC						>.40	.39	.35	.23	.23
SB							>.40	>.40	.27	.27
SA								>.40	.32	.31
CB									.28	.28
UC										>.40



the squad mix; the third bar shows the range of scores of the leading rifle squad mix (the UA mix composed of nine M14 rifles); and the fourth bar shows the CET score range for the lowest ranking rifle mix (the RA mix composed of nine AK47 rifles) (page 6-23).

The performance measure tables and the graphs complement each other, both showing the mean average scores for each mix in rank order. The tables also provide standard deviations, while the graphs provide the range of scores contributing to these deviations.

## 2. Combined Use of Descriptive Performance Measures and Statistical Probability Data

Subtables A and H (CET for Situation 2) shown above can be used to illustrate how the two types of data should be used. Subtable A indicates that mix UA (nine M14 rifles) ranks first with a CET of 77.5 minutes and mix CA (nine Colt rifles) is second with mean CET of 78.2 minutes. Subtable A does not state whether this difference as measured in the experiment is a statistically significant difference. In other words, if further experiments were conducted, what are the odds the results would go the other way? If the odds are high, it should be concluded that the measured difference is not statistically significant and that, for practical purposes, one system appears as good as the other as far as the particular measure is concerned.

In the case of the UA and CA comparison, a measure of such odds can be obtained by referring to the Subtable H adjacent to Subtable A, which shows probability (p) factors (for the two sample t-statistics). In the cell of row UA and of Column CA is the factor  $p > .40$ . This p-value indicates that a low level of statistical confidence attaches to the experimentally observed difference in Situation 2 CET as between UA and CA. As far as the experimental results are concerned, UA and CA in this situation appear about equally effective in CET.

In a comparison of UA with UC (five M14s and two M60s), however, one can read across the p-value table and see the number .03. In this comparison, confidence in the conclusion that UA is superior to UC is relatively high.

The combined use of statistical probability measures and the performance measures can serve as an aid for analysts and decision makers. In the case of the UA and CA comparison ( $p > .40$ ) discussed above, there is little evidence for concluding that there is a real difference between mixes on the measure of CET. However, the systems may very well be different regarding the other effectiveness measures. Subtable B for Situation 2 (page 6-23) shows that in near misses CA scored 323 and UA scored 259. The statistical probability is .05. Similarly, in sustainability (Subtable C) (page 6-23) CA scored 50.5 and UA 22.0, with  $p = .001$ . Thus it

might be concluded in this situation that the CET qualities of CA and UA are a toss up but that the experimental evidence strongly supports the conclusion that CA is superior to UA in near misses and sustainability. On this basis it might then be concluded that the experimental results in Situation 2 indicate that CA is the superior mix.

Successive pairs of systems can be analyzed by situation and event in the same fashion as above. Such a process, however, is time consuming and requires judgment at numerous points. One important type of judgment centers on what is the appropriate probability that should be used. Other judgments must center on possible tradeoffs suggested by the data. For example, System A produces 10 percent more near misses than System B but, relative to B, has 30 percent less sustainability in terms of the percent of ammunition remaining. Is such a tradeoff, or price in sustainability, worth the extra near misses? In part, the answer would depend on the absolute sustainability scores attained. It is one thing if A has a sustainability score of 80, and B, 50; perhaps another if A had 40 and B had 10. In the latter case a hypothetical squad might be in poor condition to resist an immediate counterattack after a successful attack.

However, it may be neither practical nor possible to go through a detailed analysis of the kind suggested here as a means of evaluating weapon mixes. It is therefore, desirable to provide an evaluation and appraisal of weapon mixes, preferably by a less involved method. To facilitate such an analysis, the concept of standard scores is useful. Hence, a short discussion of standard scores is presented in each subtable for each experimentation measure and in summary subtables.

### 3. Standard Scores

Scores obtained for weapon mixes for each of the measures in the SAWS experiment are not directly comparable between situations or between measures. For example, CET is measured in minutes, near misses in actual number, and sustainability in percent of ammunition remaining. Moreover, CET may average 3 minutes in one situation and 20 in another. In dealing with such observations, it is desirable to have scores that can be easily compared. This is what standard scores do.

Consider the following hypothetical example for a situation.

Measure of Effectiveness	Mean Score $\bar{X}$	SD	Raw Scores		Deviations		Standard Score (Z)		Adjusted Std Score (Z)	
			Mix		Mix		Mix		Mix	
			A	B	A	B	A	B	A	B
Near Misses	155.7	26.4	196	162	40.3	6.3	1.53	.24	79.8	80.6
CET	33.7	8.2	20	44	-13.7	10.3	-1.67	1.25	16.6	75.0

In this example, the mean score ( $\bar{X}$ ) represents the average of the raw scores of the ten mixes in a given situation. The example also shows the standard deviation (SD) of these raw score averages.

Consider next the raw score measures for Mixes A and B. Note, for example, Mix A's near miss performance deviates from the mean score of all mixes by 40.3. When this raw deviation for the mix is divided by the standard deviation of the group score (26.4), the standard score (Z) of 1.53 is obtained.

Such measures have a mean of zero and a standard deviation 1. To eliminate negative scores and put them on a scale similar to conventional scoring methods, they can be adjusted by selected constant factors. For the purpose of this experiment, they were adjusted as follows:

$$z' = 50 + 20 \frac{X_1 - \bar{X}}{SD}$$

where the expression in the brackets represents the standard score z, as shown in the table above, and z' represents the adjusted standard scores.\*

The standard score, therefore, is used in this report as a numerical representation, or index, to facilitate understanding the relative effectiveness of each weapon system mix in each situation. A standard score that is below 50 automatically indicates that the actual performance of that weapon mix was above the average for that measure.

The standard scores not only provide an immediate index of whether weapons systems performance is above or below the average but they also provide an immediate visual index of how far that squad weapon mix's performance deviates from the average in relation to how far the other mixes deviate from the same average.

\*  $X_1$  is the raw score of the mix,  $\bar{X}$  is the average raw score of all mixes, and SD is the standard deviation of the raw scores for all mixes.

The standard scores thus provide a ready means of combining the various performance measures. All performance measures (CET, near misses, sustainability, number of targets hit, and total number of hits) now have an identical average score of 50 and identical standard deviation of 20. Thus, if a weapon mix is above average in both CET and near misses, the results of combining these standard scores, no matter what weights were assigned to each must show a resulting mean (average) standard score of above 50--since its above average performance on both measures required it to have a standard score of above 50 on both measures. Therefore, although raw scores of different variables cannot be meaningfully combined, the standard scores can.

The combining of standard scores rather than the direct averaging of ranks, or some similar method, also takes into consideration the relative superiority or inferiority of the performances of different mixes on different measures. For example, it will be noted that mix UA did better than mix SB on the target effectiveness measure of CET in Situation 5--but that mix SB did better in the other target effectiveness measures of the number of near misses. If a decision were to be made to weight these two measures equally, the conclusion might be drawn that UA and SB were equal to each other in target effects, since UA was higher than SB on one of the measures while SB was higher on the other measure. A comparison of the standard scores presented below, however, might lead to a different conclusion.

Mix	CET		Near Misses			Target Effects
	Rank Order	Std Score	Rank Order	Std Score	Rank Order	Std Score*
UA	1	54.45	2	46.7	2	(Av of CET and NM) 50.57
SB	2	53.67	1	71.3	1	62.49

\* If CET and near misses were weighted equally

Therefore, combining standard scores to assist in the interpretation of results automatically considers that although mix UA was better than mix SB in CET, the difference was very slight; but that in the case of near misses, when SB was better than UA, the difference was relatively much larger.

\* If CET and near misses were weighted equally.

#### 4. SAWS Target Effects and Overall Effectiveness Scores

Subtables F and G of the consolidated tables for each situation present the average standard scores for each mix in target effects and overall effectiveness. Subtable F provides, in rank order, the overall standard scores for target effects (CET and near misses) combined. Subtable G presents the overall standard scores, in rank order, of the weapon mixes for target effects (CET and near misses) combined with the third primary effectiveness measure of sustainability (percentage of basic load of ammunition remaining at the conclusion of each situation).

Subtable F, therefore, presents the overall standard scores of weapon mixes rank ordered according to their overall target effects. For illustrative purposes, CET (representing targets hit as a function of time) has been equated in Subtable G with near misses (representing the number of near misses per unit of time). There are, mathematically, an infinite number of weightings that can be given other than the arbitrary 1-to-1 weights presented. If it were desired, for example, to weight near misses in the assault twice as much as CET, then the near miss standard score provided in Subtable B would be multiplied by 2, added to the CET standard score for Subtable A, and the result divided by 3.

In Situation 4 (Rifle Squad Approach to Contact), Situation 7 (Rifle Squad in Day Defense), Situation 8 (Rifle Squad in Night Defense), and Situation 9 (Machinegun Squad in Day Defense) near misses were not measured. Therefore, the overall target effects standard scores presented in Subtable F are based solely on CET. Thus, for these situations, the standard scores in Subtable F are identical to those in Subtable A (CET).

Subtable G presents the combined overall standard scores for each situation for all of the primary effectiveness measures (CET, near misses, and sustainability). In other words, Subtable G combines each of the primary effectiveness measures used in the experiment into an overall effectiveness criterion and rank orders the weapons mixes accordingly. It must be emphasized that these rank orders, for illustrative purposes only, weight each of the primary effectiveness measures equally. Thus, CET, near misses, and sustainability each contribute to one-third of each weapon mix's overall rank order, which in effect weights target effects (CET and near misses) two-thirds and sustainability one-third.

In Situations 4, 7, 8, and 9, where scores for target effects are based solely on first hits as a function of time (CET), target effects are still weighted two-thirds and sustainability one-third. Thus, regardless of the situation, the overall ranking of weapon mixes, as presented in Subtable G, is always the result of giving sustainability a weight of one-third.

For rifle squad Situation 2 (Base of Fire supporting the Assault), Situation 5, Rifle Squad as a Base of Fire Supporting the Advance), Situation 7 (Defense Against Attack), and Situation 8 (Night Defense Against Attack), there is a fifth column for each Subtable C (Sustainability). This

column (titled "Sustainability Time") lists, in minutes, the amount of time that each of the given squad mixes would be able to sustain itself in that situation. Thus, if a squad weapon mix fired 75 percent of its ammunition over the 4 minute duration of Situation 2 (Base of Fire Supporting the Assault), the weapon mix was considered capable of sustaining itself in such a situation for 5.33 minutes.\*

5. Expected Scores

The method of computing expected scores was the same for Series 1 and 2 of Situations 7, Series 1 and 2 of Situation 8, and the duplex experiment. The equations used to calculate expected scores for primary and collateral measures and the basic proportions used in these calculations were the same for each situation. This basic format was constructed as follows:

	<u>Experimentation</u> <u>Squads</u>	<u>Control</u> <u>Squads</u>
Series 1 (first firing)	$A_m$	$B_m$
Series 2 (second firing)	$C_d$	$D_m$

M = The mode of fire (ball or duplex, automatic or semiautomatic) used by all squads of the mix during their first firing of the situation

\* The figures presented in the subtables of the various tables for each event provide the USACDCEC SAWS data in terms of means (averages), standard deviations, standard scores, and probabilities (illustrating levels of significance). However, there are a number of technical rules for the precise interpretation of these statistics; and a number of mathematical assumptions that must be satisfied if these are to be used precisely and in the most meaningful manner. In the final analysis, each score and statistic presented can be looked at and considered only in conjunction with all other statistics of the table. Thus, rank orders of weapons systems and standard scores have full meaning only in conjunction with the values in the probability subtables (H, I, J, K, and L). Furthermore, for a precise interpretation, it is necessary to be thoroughly familiar with the many assumptions inherent to the various statistical procedures and measures used and to understand thoroughly the mathematical relationships between these measures. An attempt has therefore been made to provide sufficient data to allow the reader to reconstruct the various situations, perform his own analyses, and draw his own conclusions. In this respect the chi square values for Bartlett's Test for Homogeneity of Variance as well as F values and corresponding probabilities for these F ratios are also presented.

**D = The mode of fire used by three of the six rifle squads during the second firing, and the mode against which a comparison with the first firing's M mode was desired**

**A<sub>m</sub>=Average scores for the three experimental squads (usually the odd numbered squads of the mix) after their first firing in M mode**

**B<sub>m</sub>=Average score for the three control squads (usually the even numbered squads of the mix) after their first firing in M mode**

**D<sub>m</sub>=Average score for the three control squads after their second firing of the situation using M mode**

**C<sub>d</sub>=Average score for the three experimental squads after their second firing of the situation, but using D mode rather than M, which was used during their first firing, and which control squads continued using**

The equation used to calculate the expected mix score (the score that would have been expected of the entire six squad mixes from the first firing of the situation if mode D, rather than M, had been used) reads:

$$\text{Mix Expected} = \frac{(A+B) \left(1 + \frac{BC - AD}{AD}\right)}{2}$$

**6. Graphical Presentation of Measures as a Function of Time and Range**

Results for rifle squad situations are also presented in the form of graphs. Hits, near misses, total hits, percent of ammunition expended, and number of rounds fired are illustrated all as a function of time and range. Except for Situations 7, and 8, time is represented on one axis and the measure of effectiveness on the other. All the measures indicated above may not be represented on all graphs.

Because the targets were programmed to rise and fall in sequence at different times in Situations 7 and 8, either individually or in groups, distributions of the effectiveness measures as a function of scenario time were not applicable. For Situation 7 and 8, therefore, the measures have been cumulatively plotted, starting with the targets at the greatest range (which came up first) and cumulating the measures through the assault targets that were closest to the firers and came up last.

These graphs present the relative effectiveness of the various weapon mixes at different ranges, and at different times in each situation. They also permit a ready analysis by weapon mix of the relationship of the various measures to each other at varying ranges and times.

For example, Figure 3-1 illustrates the distribution of targets hit and near misses for hypothetical Mixes A and B in Situation 1 (Rifle Squad in Line Assault).

The time scale is presented at the bottom of each graph. The range scale is presented on the center line between two graphs.

An examination of the graphs by comparing the maximum point of each curve (intersection of curves with right vertical axis) shows that Weapon Mixes A and B are equivalent in total number of near misses (400), but that Mix B is superior to Mix A in the number of targets hit during the Assault Situation (6.5 versus 4.5). Examination shows that the squads of Mix A averaged their first target hit (indicated by \* on the curve) in the Assault at a range of 50 meters from the targets while Mix B averaged its first hit in the Assault at a range of 100 meters from the targets. A comparison of the curves further shows that Mix A squads hit, on the average, only one target during the movement from 130 meters in to 50 meters, while Mix B during the same time of movement across the same amount of ground had hit an average of three targets. However, the slopes and increase in curve ordinates between 50 meters and the end of the assault (30 meters from the targets in the experiment due to danger of damaging ground level target instrumentation) shows that both mixes averaged an identical 3.5 targets hit during this period. Examination of these graphs indicates that both mixes were equivalent in the Assault in their suppressive fire effects as a function of near misses and in their ability to hit targets at a range of 50 meters and closer, but that Mix B is superior in its ability to hit targets at ranges of more than 50 meters. Mix B's overall superiority at the completion of the Assault is therefore due solely to its superiority in attaining hits at ranges of more than 50 meters.

Figure 3-2 presents data for hypothetical Mix C from Situation 2 (Rifle Squad as a Base of Fire in Support of the Assault, ranges of 269 to 326 meters). The center vertical dashed line represents the division between the two target arrays. (See Section II for a description of Situation 2.) The first 2 minutes of fire were directed at the left array of 17 targets. At the end of 2 minutes (indicated by the time scale on the horizontal axis) firers shifted fire to the right array to reproduce the effects of the shift of fire that is necessary when the assault element closes with the enemy position.



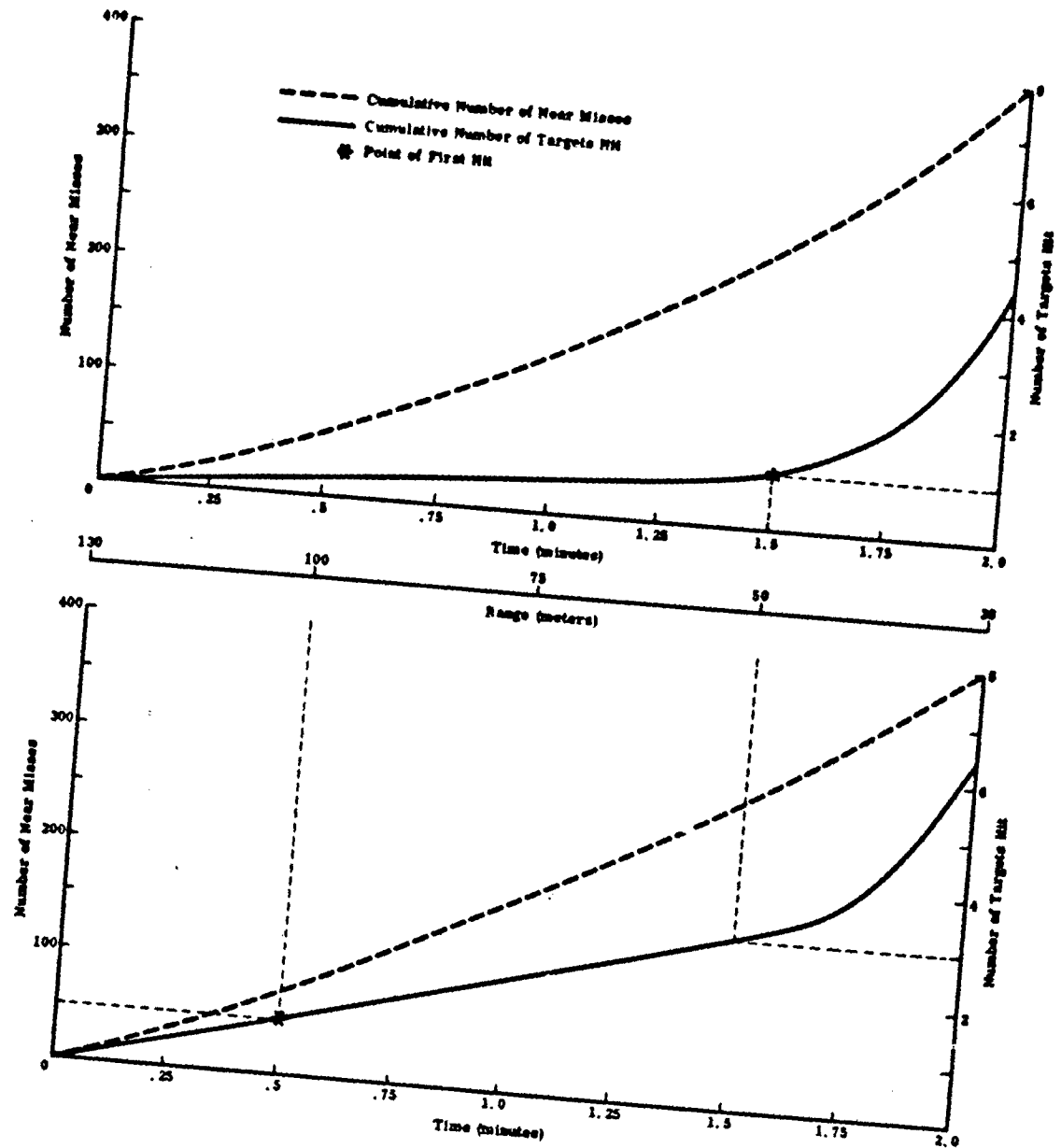

Figure 3-1 DISTRIBUTION OF DATA, HYPOTHETICAL WEAPON-SQUAD MIX A (top) AND MIX B (bottom) IN SITUATION 1 (RIFLE SQUAD IN THE LINE ASSAULT)

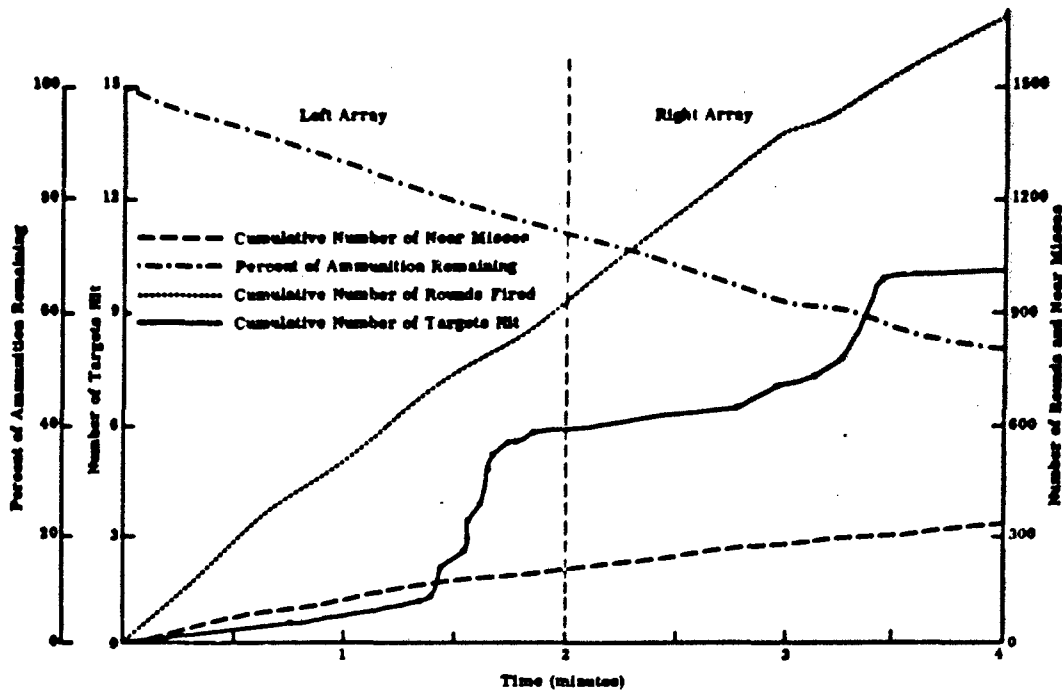

Figure 3-2 DISTRIBUTION OF DATA, HYPOTHETICAL WEAPON-SQUAD MIX C IN SITUATION 2 (RIFLE SQUAD AS A BASE OF FIRE IN SUPPORT OF THE ASSAULT)

In this example (Figure 3-2) it can be seen that the number of rounds fired and the number of near misses rose steadily and at a constant rate throughout the 4 minutes of fire. For every near miss registered within 2 meters of a target there were 5 rounds fired. By comparing the ends of the curves, it can also be seen that there were 1700 rounds fired and 10.5 targets hit, or one target hit for each 162 rounds fired. But, unlike near misses and ammunition expenditure, most of the targets hit for each array were hit during the latter portion of the 2 minute firing times. The graph shows that even though the rate of ammunition consumption and near misses for hypothetical Mix C is constant during the entire situation, the rate of hits is not. There were practically no hits during the first minute of fire on each array; however, during the latter part of the firing on each array the rate of hits increased at an extremely high rate. A gentle sloping curve, therefore, indicates that there were few hits while a steep slope of the curve indicates a high rate of hits.

Figure 3-3 presents an example of cumulative exposure time (CET) plotted as a function of range for a situation similar to Situation 7. In this situation targets rose individually or in small groups for brief exposures. The program provided for a sequence of target exposures starting at distant ranges and culminating in the exposure of ten close range (approximately 45 meter) targets. The exposure times of each target are cumulated from the most distant target through the closest target (from left to right on the horizontal axis of the graph). If every target were hit at precisely the same instant that it appeared, the target exposure time would be theoretically zero and the CET curve would be a horizontal line corresponding with the horizontal axis of the graph. On the other hand, if no target were ever hit, each target would remain up for its entire programmed exposure time, represented in Figure 3-3 by the curve labeled CPET (cumulative programmed exposure time). Therefore, all curves for all mixes must fall somewhere between the CPET curve and the horizontal axis. Thus, the mix with the CET curve closest to the horizontal axis hits the targets the quickest. The intersection of this curve with the right vertical axis of the graph represents the CET of that mix for the entire situation. A comparison of the slopes of the curves of any two mixes for any range increment will show which weapon mix was superior at that range. The mix with the curve that has the steepest slope at any given range is the poorest mix at that range.

Also illustrated are curves for the number of targets hit, the total number of hits and ammunition expenditure. From Figure 3-3, it can be seen that ammunition expenditure was greatest at the longer ranges while the number of targets hit was the least, and that it took longer to hit the targets that were hit. At the closest ranges (45 to 60 meters), however, there was very little ammunition expended (almost horizontal slope of the "rounds fired" and "percent of ammunition remaining" curves), yet the curves for both number of first hits (targets hit) and number of total hits on targets increases sharply in slope. Furthermore, not only are more

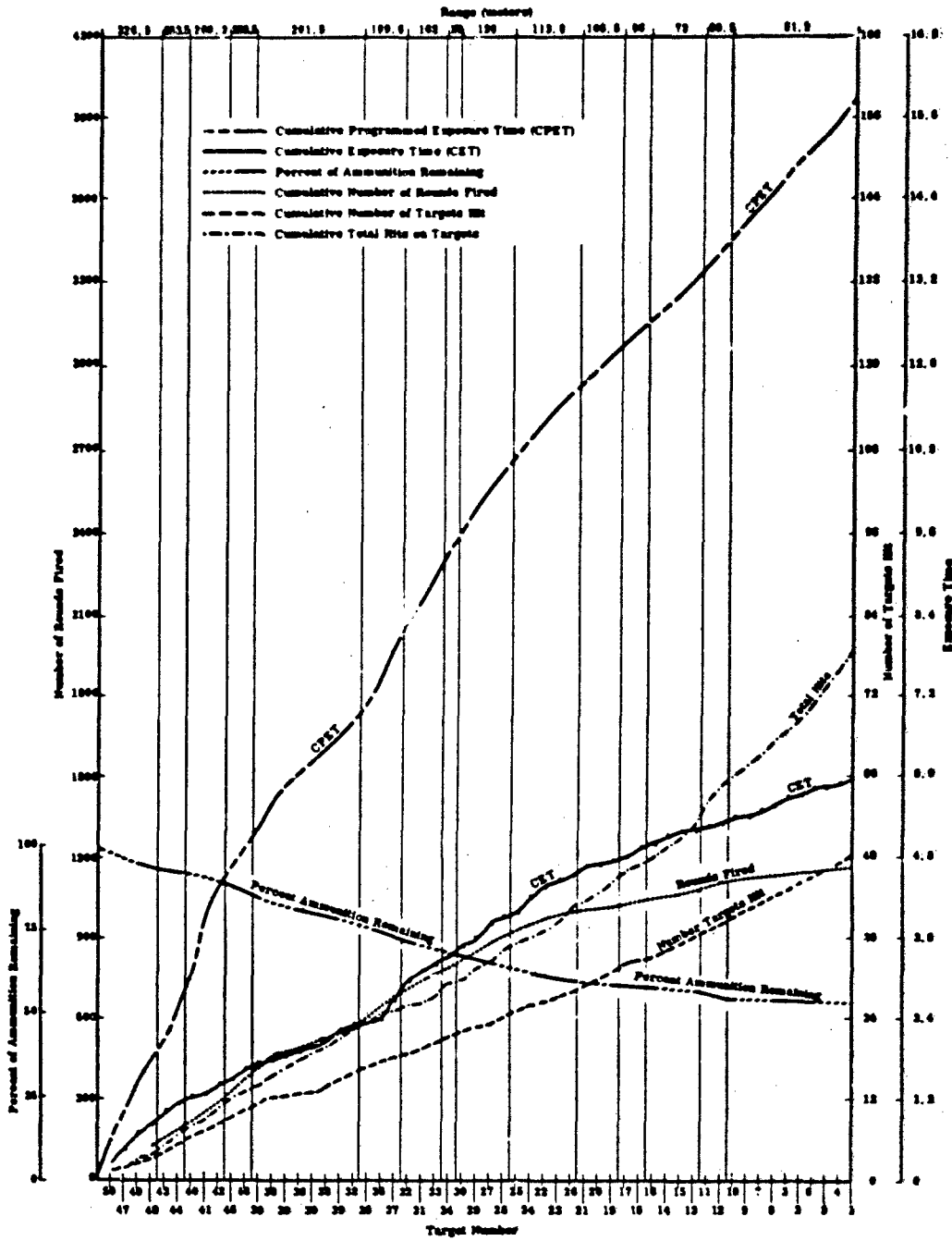

Figure 3-3 EXAMPLE OF CET AS A FUNCTION OF RANGE

targets hit but they are hit more quickly, as indicated by the relatively flat CET curve at the 45 and 60 meter ranges. The fact that the targets were hit so quickly can, of course, be related here to the fact that very little ammunition was expended. Had the targets not been hit so quickly, they would have been fired at for a longer time with a resulting increase in the amount of ammunition expended.

These graphical presentations of the distribution of effectiveness measures as a function of time and range permit a ready comparison of the behavior of the various effectiveness measures within a weapons mix, while at the same time permitting a comparison of the mixes with each other at varying ranges and under varying conditions.

#### 7. Histogram (Bar Graph) Presentation of Near Misses as a Function of Target Location

For situations where near misses were recorded, the distribution of near misses across the target arrays are presented in the form of histograms, as in Figure 3-4. There is one histogram for each mix for each applicable situation. Each vertical bar represents one target. The height of the bar depicts the average total number of near misses by the six squads of the weapon mix for that target. Each set of histograms is accompanied by a schematic sketch (to scale) of the target array to which the histogram applies. The type of weapon simulator associated with each target and the target number is given at the bottom of each vertical bar. The targets (vertical bars) are shown from left to right in the same order that they appear in the actual array (and in the inset schematic).

A comparison of the relative effects of automatic firing and semiautomatic firing weapons regarding distribution of fire patterns is possible through a comparison of these histograms, as is a comparison of the relative suppressive effects of the different weapon systems and mixes. An analysis of the distribution of fire in the target area relative to the type of enemy fire from the position allows conclusions to be drawn regarding the extent to which fire is drawn to automatic weapons as opposed to relatively slow firing semiautomatic rifles (indicated by R on the histogram).

The example (Figure 3-4) shows no apparent relationship between types of enemy weapon and distribution of fire at first glance. In fact, Position 10, a rifle position firing a small volume of semiautomatic fire (simulator fired spaced single shots), received more near misses than any other target. However, examination of the inset schematic of the target array shows that this target was located directly in front of a machinegun and down the slope from it. It is also located between many of the firers and three other targets (two rifles and one automatic rifle). Therefore,

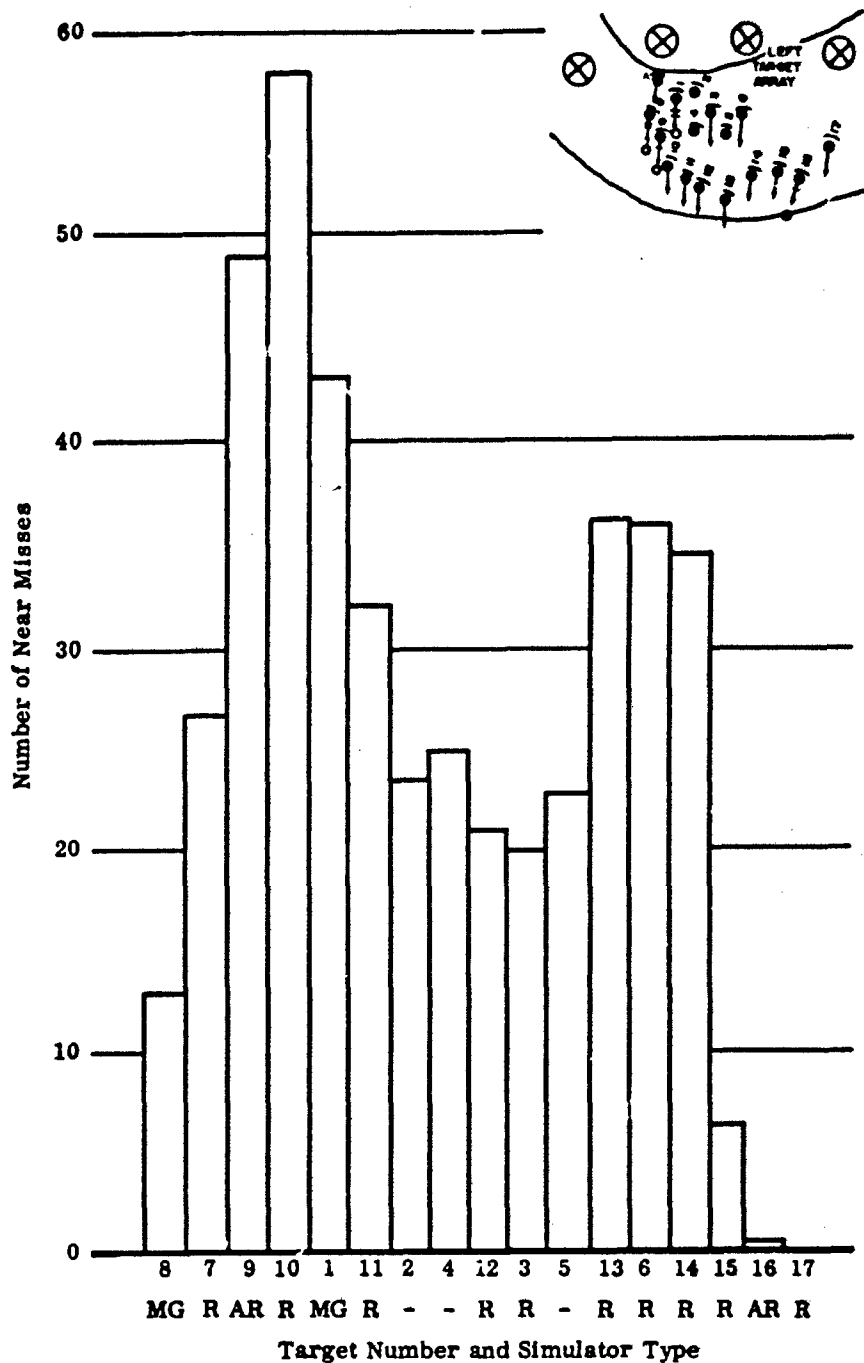

Figure 3-4 HISTOGRAM (BAR GRAPH) PRESENTATION, NEAR MISSES AS A FUNCTION OF TARGET LOCATION

It can be seen through a comparison of the histogram and the schematic sketch that rounds fired at a machinegun, an automatic rifle, and two other riflemen would all pass close to Target 10. Thus, one round of ammunition may register as a near miss on as many as four different targets, in the same manner that one round is capable of contributing to the suppressions of more than one soldier in combat. It also becomes obvious that a ratio of the total number of near misses (as registered in the SAWS experiment) to the number of rounds fired cannot be interpreted as the probability that any given round will be within a given distance of the target. For example, if 2000 rounds were fired by a weapon mix and 200 near misses were recorded, it does not mean that one out of every ten rounds ( $\frac{2000}{200} = 10$ ) passed within the 2 meter near miss zone of a target, because one round may have been registered as a near miss by two or more targets.

This histogram may therefore be used as a primary tool for analysis of the mechanisms of distribution of fire, interactions of target-firer characteristics, and for comparison of the various weapon mixes regarding both suppressive fire and distribution of fire characteristics. Not included in this report, but available at USACDCEC for analysis, are detailed breakdowns of near misses for each individual target as a function of time and range. When related to data regarding the frequency that specific targets were hit, analysis permits a determination of the pattern of random and aimed hits as a function of distribution of fire.

#### D. ANALYSIS AND DERIVATION OF CONCLUSIONS

The following five sections (Section IV through VII, and IX) present results of the SAWS experiments and deal with the USACDCEC SAWS conclusions and the analyses from which the conclusions were evolved.

USACDCEC has, in effect, presented the results of the SAWS experiment in a format of tables and graphs allowing independent mathematical analysis of the data presented. At the same time decision makers are permitted to integrate military judgment into the mathematical results.

In formulating its conclusions, USACDCEC has exercised military judgment only to the limited extent that on some occasions a judgmental decision had to be made, regarding, for example, the implications of the ability of a weapon to sustain itself when all other things were equal. If target effects are approximately equal for two weapon mixes, but one mix is significantly better than the other in its ability to sustain these effects, then the weapon mix with the sustainability advantage would normally be chosen. In like manner, although the average score for one mix might be superior to the average score for another mix, it becomes necessary to consider just how valid and of how much practical importance the differences are.

In combining scores for the presentation of combined overall results in the various tables, cumulative exposure time, near misses, and sustainability were weighted equally (except where near misses were not measured), as were each of the rifle squad situations. However, before any conclusions could be drawn on the basis of rank orders, raw scores, or standard scores, it was necessary to consider each difference in connection with the probabilities that the numerical differences were really valid differences and not the result of operations of chance factors. It was then necessary to conduct sensitivity analyses of the data to determine the degree of sensitivity of the rankings to changes in the weightings of the criterion measures and situations.

For example, Mix SC (seven Stoner rifles and two Stoner machineguns) ranks in the top position in combined target effects across all rifle situations. Sensitivity analysis showed that it also ranks at least third in every situation and was superior in target effects to every US 7.62mm mix in each of the six situations. Therefore, it does not matter how much any given situation is weighted, the mix composed of seven Stoner rifles and two Stoner machineguns always comes out superior to every one of the US 7.62mm mixes. It may therefore be concluded that Mix SC is superior to any 7.62mm weapon mix in target effects.

Analysis of the quantitative differences between weapon mixes (or systems), judged by the quality of the differences as indicated by various statistical measures including probabilities (statistical significance of the differences), provided the mathematical context from which USACDCEC SAWS conclusions were evolved.

As stated previously, the end results are relatively insensitive to varying the weights of the different situations and effectiveness criteria. No matter how much weight is assigned, the same weapon systems consistently come out ahead of the others in target effects, sustainability, and overall effectiveness.

Despite the numerous presentations in this volume, the data base has scarcely been touched. The quantity and nature of the SAWS data is sufficient to evoke and feed a thoughtful and fruitful analytical endeavor for many years. For example, the brief discussion describing the graphical and histogram presentations of data (paragraphs 6 and 7 of this section) provides the basis for an entire anatomy of analysis. Reflective examination of the time histories of fire effects, ammunition consumption, and distribution of fire effects provide keener insights into the use of small arms. There are numerous ways in which the data can be synthesized or combined to provide further insight into weapon choice, organization, and doctrine.



**BLANK PAGE**

## SECTION IV

### TRAINING RESULTS

The primary measures of training performance were firing scores on the various ranges. Firing scores were taken at fixed points in the training program. At each of the times firing scores were taken, each weapon system group had the same amount of training of the same kind under comparable conditions.

Thus, the scores obtained reflect, in part, any weapon system differences that might have existed when the measures were taken. However, these scores were also affected by such factors as weather, time of day, visibility, and motivation, all of which often differed from day to day. Their exact quantitative influence is often not assessable in precise measurable terms, and they must be often accepted as sources of uncontrolled variation. Where there were differences in group scores, the differences may have resulted from differences in ease or effectiveness of training, or from some other weapon system characteristics that are not affected by training, or from uncontrolled factors of the type mentioned above. The fact that the scores may have reflected more than one factor does not invalidate the results of the training assessment, but it makes for a less precise interpretation of results than would otherwise be the case. The interpretation of results also depends on the assumption that the selection process produced weapon system groups that were comparable in learning ability and trainability in small arms firing. There were no known sources of selection bias.

#### A. RIFLE

##### 1. Disassembly and Assembly

Four tests were carried out to determine the ability to disassemble and assemble the different weapons. For each test, the men were required to disassemble the rifle, and their performances were timed. Times required for all men to disassemble their weapons on the first trial of each test were averaged for each weapon system group. Assembly tests were carried out in the same manner. The first trial of each of the four tests was timed and weapon system group averages were computed. The average times for each test are presented in Table 4-1. When a man had difficulty in disassembling or assembling a part or parts of the weapon, he received assistance from the instructor. These periods of assistance are reflected in longer disassembly and assembly times. It is notable that as the men equipped with the Stoner and M16E1 became more familiar with their weapons they required less assistance, and their times rapidly decreased

**Table 4-1**  
**RIFLE**  
**DISASSEMBLY AND ASSEMBLY TEST**  
**(Average Times)**

Weapon	Test	Average Disassembly Time (Seconds)	Average Assembly Time (Seconds)
M14 (1)	1	47	75
	2	31	54
	3	23	53
	4	20	51
M16E1	1	119	207
	2	72	124
	3	50	99
	4	30	50
Stoner Rifle	1	116	172
	2	79	115
	3	69	99
	4	27	50
M14 (2)	1	42	69
	2	29	52
	3	26	52
	4	23	49
M14E2	1	47	74
	2	38	60
	3	29	57
	4	24	56
AK47 (1)	1	27	50
	2	22	33
	3	12	25
	4	10	24
AK47 (2)	1	36	63
	2	24	37
	3	16	30
	4	15	28

to approximate that of the M14 group (which had received training in their weapon before the training experiment). On the first test, the differences in performance times for the various weapons were quite marked: the AK47 times were shortest, followed by the M14 and M14E2, the Stoner rifle, and the M16E1. On each succeeding test, the differences were reduced, and by the fourth test they were small. These trends are presented graphically in Figures 4-1 and 4-2. The fourth test did not include removal of the Stoner forestock assembly or the Colt handguard assembly. Therefore, the times for the fourth Stoner and Colt test are not comparable to the results obtained on the earlier Stoner and Colt rifle tests or the other weapons tests.

The least difficult weapon to disassemble and assemble proved to be the AK47. Subjects also were able to disassemble or assemble this weapon more quickly than any other.

Although tight fitting parts caused initial difficulty with some US weapons, this situation was later corrected. It is concluded that there are no tactically significant differences among US weapons regarding ease of disassembly or assembly, or the times required for disassembly or assembly after equivalent training.

## 2. Trainfire Record Range

Two ranges were used in these firings. All groups fired the record ranges twice. On the second record firing, half of each weapons group fired on each of the two Fort Ord Record Ranges (Range 18 and 19) to balance out range differences. Each man fired about 96 rounds on the record range. Individual hit tabulations were made, and the scores were based on the average number of hits achieved by each weapon system group. The average scores for each group, and for each firing on each range are presented in Table 4-2. The scores range from 44.00 for an AK47 group on their second firing (Range 19) to 57.71 for an M14E2 group on their second firing (Range 18). It should be noted that all record firings were made in semiautomatic fire.

Only four groups of firings by different weapons are directly comparable. M14 Groups K and L are comparable to Colt Groups M and N. For all other record firings, condition of camouflage on the ranges, weather, time of day and other factors were different. Because of time and range limitations a balancing of record firings was not possible. However, it was clearly determined that record scores secured by firers were more a function of the particular range used and the time of day than of differences in either firing ability or weapons. For example, firers who fired on Range 18 in the afternoon always did extremely well and achieved a relatively large number of expert qualifications, regardless of the personnel or weapon used. In contrast, firers who fired on Range 19 in the early

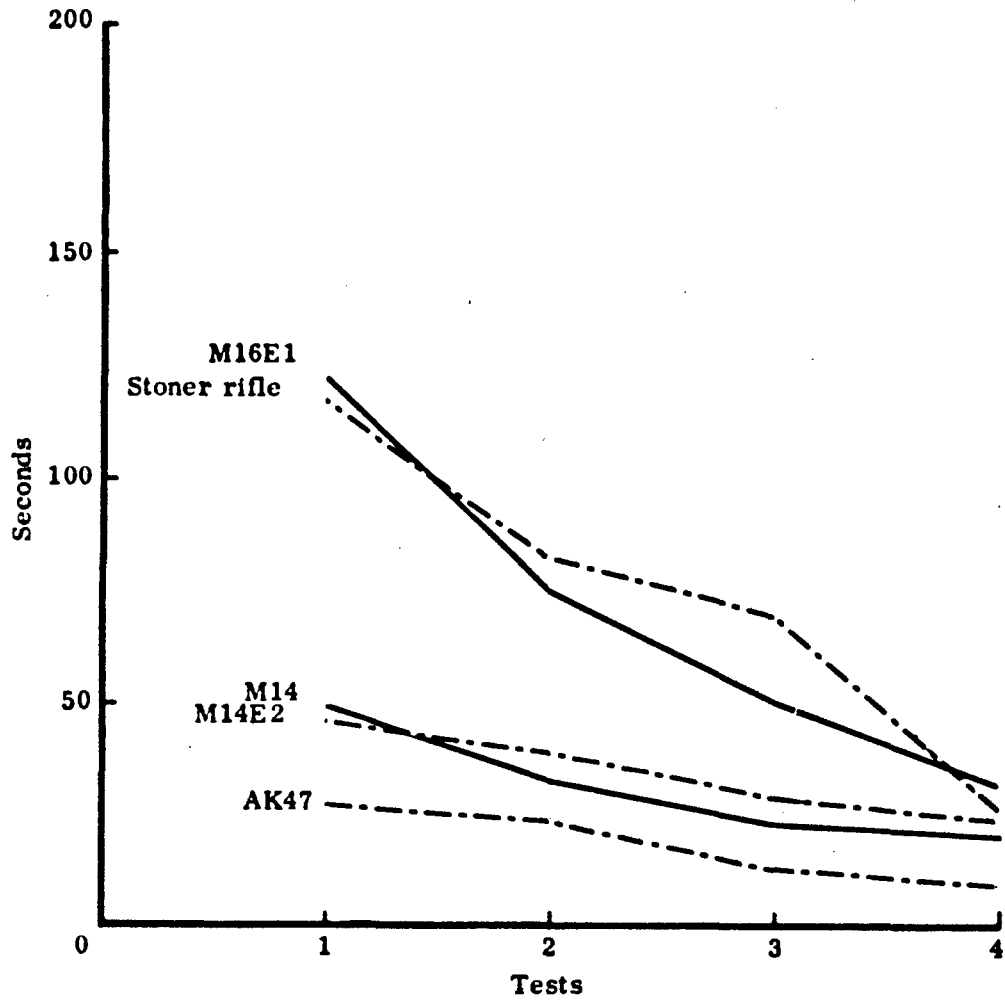

Figure 4-1  
DISASSEMBLY TIME OF RIFLES

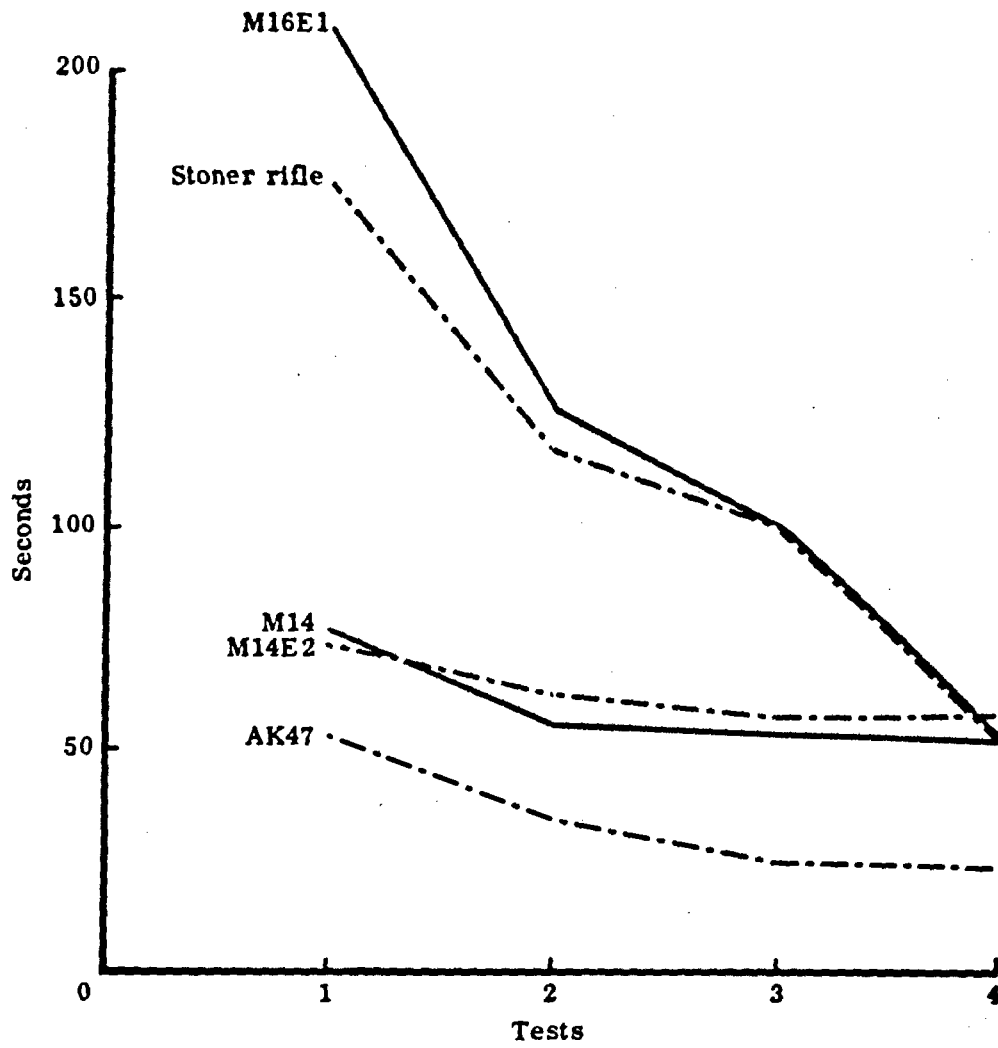

Figure 4-2  
ASSEMBLY TIME OF RIFLES

**Table 4-2  
RIFLE RECORD FIRE QUALIFICATION SCORES**

Weapon	Range	GP	N	Avg	$\sigma$	Date (1965)	Range	GP	N	Avg	$\sigma$	Date (1965)
M14 (128)	19	A	127	45.36	8.99	28 Aug	19	K	60	49.60	8.56	29 Sep
							18	L	55	50.27	8.61	29 Sep
M16E1 (128)	18	B	127	52.66	8.71	28 Aug	19	M	60	54.61	9.11	29 Sep
							18	N	62	56.81	8.16	29 Sep
Stoner (184)	19	C	84	44.45	10.65	7 Sep	19	O	39	48.64	8.54	25 Sep
							18	P	36	52.14	9.09	25 Sep
	18	D	86	54.20	9.48	7 Sep	19	Q	28	51.71	11.74	25 Sep
							18	R	56	54.92	9.83	25 Sep
M14 (56)	19	E	26	48.58	7.63	22 Sep	19	S	14	53.36	6.65	2 Oct
							18	T	12	56.50	6.14	2 Oct
	18	F	27	50.11	7.02	22 Sep	19	U	13	52.77	5.70	2 Oct
							18	V	14	55.93	6.65	2 Oct
M14E2 (72)	19	G	36	52.50	7.48	22 Sep	19	W	18	55.44	7.12	2 Oct
							18	X	17	51.24	9.26	2 Oct
	18	H	36	54.25	10.35	22 Sep	19	Y	16	51.56	5.89	2 Oct
							18	Z	17	57.71	7.53	2 Oct
AK47 (21)	18	I	21	47.38	7.78	22 Sep	19	AA	21	52.57	7.94	2 Oct
AK47 (35)	18	J	39	46.67	8.82	9 Oct	19	BB	34	44.00	7.69	23 Oct

**NOTE:**

Because of different range conditions, weather, and other factors, these scores are not comparable except as discussed in the text.

CODE: GP Group Designation  
 N Number of Personnel in Group  
 AV Average Record Score  
 $\sigma$  Standard Deviation

morning did poorly and were seldom able to qualify as experts, regardless of their marksmanship ability or the weapon used.

After the two groups had received equivalent training, the M14 combined group average score (K and L) was 49.4, and the group average score for the Colt rifles (M and N) was 55.71. A level of significance of .001 is attached to this difference. The fact that these Colt rifle scores were higher than the M14 scores is particularly significant when it is considered that, in addition to the SAWS training, the M14 firers had all previously qualified with the M14 and most of them had been using an M14 for more than two years, where the Colt firers first fired the M16E1 during the training period immediately preceding the record firings.

As in the experiment itself, the AK47 scores were low compared to scores of other weapons. This is attributed to the AK47's short barrel (short distance between sights) on the weapons, to varying lots and characteristics of ammunition, to low visibility (fog) conditions on the ranges during the last firing, to the relatively excessive amount of barrel wear of the weapons, and to the fact that the 13 experimental weapons (through 24 December 1965) were shared by all AK47 firers, which necessitated continuous zeroing adjustments. Because both front and rear sights are adjustable this weapon sharing problem may have had more significance for the AK47 than it would have had for other weapons.

### 3. 25 Meter Rifle in Automatic Mode

Each man fired 20 rounds in each of three positions--hip, under-arm, and standing. The average number of hits for each weapon group in each position is given in Table 4-3. Two groups of M14 firers and two groups of AK47 firers fired at different times, and their scores are tabulated separately. Scores varied greatly, and the large difference between scores for different groups assigned to the same weapon type is unexplainable. For example, one AK47 group finished first in two of three positions, but the other AK47 group finished last in the same two positions.

### 4. 200 Meter Rifle in the Automatic Mode

Two exercises were repeated three times for this test: in the first, 20 rounds were fired at point targets in 40 seconds; in the second, 30 rounds were fired at point targets in 50 seconds. All firings were in the prone position, but the M14E2, M16E1, and Stoner rifle used their integral bipods, and the M14 and AK47 fired without bipod. Averages for each weapon group in each exercise are given in Table 4-4.



**Table 4-3**  
**AVERAGE NUMBER OF HITS BY RIFLE IN AUTOMATIC MODE**  
**(25-meter Range)**

Weapon	Firing Position						N
	Hip		Underarm		Standing		
	Rank Order	Score	Rank Order	Score	Rank Order	Score	
M14 (sample)	6	2.21	5	3.12	3	9.81	124
M14 (sample)	4	3.46	3	3.44	6	9.56	54
Stoner rifle	2	4.34	2	4.11	1	10.60	160
M16E1	5	2.73	4	3.32	2	10.52	126
M14E2	3	4.12	6	2.41	7	7.60	68
AK47 (sample)	1	5.95	1	4.24	4	9.71	21
AK47 (sample)	7	2.16	7	2.32	5	9.61	38

**Table 4-4**  
**AVERAGE NUMBER OF HITS BY RIFLE IN AUTOMATIC MODE**  
**(200-meter Range)**

Weapon	Exercise 1 <sup>A</sup>			Exercise 2 <sup>A</sup>			N
	1	2	3	1	2	3	
M14 (sample 1) <sup>B</sup>	4.32	3.66	3.68	4.28	4.53	4.49	123
M14 (sample 2) <sup>B</sup>	4.02	3.43	3.22	4.24	4.80	4.76	51
Stoner rifle <sup>C</sup>	6.34	6.60	6.51	8.53	9.05	7.71	166
M16E1 <sup>C</sup>	7.28	7.47	7.43	9.61	9.17	9.22	126
M14E2 <sup>C</sup>	7.30	8.72	9.00	9.71	10.61	10.77	69
AK47 (sample 1) <sup>B</sup>	2.67	2.48	4.33	2.95	4.38	3.95	21
AK47 (sample 2) <sup>B</sup>	2.67	3.26	3.92	4.36	5.05	5.46	39

<sup>A</sup> Two exercises were each run three times. Exercise 1: 20 rounds, 40 seconds. Exercise 2: 30 rounds, 50 seconds.

<sup>B</sup> No bipod

<sup>C</sup> Bipod-supported

## B. AUTOMATIC RIFLE

### 1. Disassembly and Assembly

Four separate tests were conducted exactly like the rifle tests. The times required to complete each test successfully are given in Table 4-5. Trends are similar to trends for the rifle; that is, differences in time were relatively large on the first test, but they narrowed on each succeeding test until they were quite small by the fourth (Figures 4-3 and 4-4). The Stoner weapons showed the longest times and the M14E2 showed the shortest. On Test 4, the Stoner task was performed only up to the carrier cap assembly, which accounts in part for the shorter Stoner times.

### 2. Interim Transition Record

For this test, each weapon was fired in each of three lanes: in Lane 1 (foxhole position), 24 rounds were fired in 28 seconds; in Lane 2 (prone position), 36 rounds were fired in 36 seconds; in Lane 3 (prone), 14 rounds were fired in 28 seconds. Scores were tabulated separately for both hits and targets hit. The averages for each weapon group are given in Table 4-6.

### 3. 25-meter Automatic Rifle

In this test, each man fired 20 rounds in each of two positions (underarm unsupported and hipsling supported). The averages for each weapon are given in Table 4-7.

## C. MACHINEGUN

### 1. Assembly and Disassembly

The four tests used for the rifle and automatic rifle, were repeated for the machinegun. The times and numbers completing the first trial on each of the four tests are given in Table 4-8. The Stoner times were generally the longest for both assembly and disassembly, and the RPD times were the shortest. Also as before, the time differences on the first test were relatively large, but they were reduced as testing progressed. Figures 4-5 and 4-6 indicate the trends.

### 2. Record Firing, Tables II, III, and IV

For this test, each man fired 104 rounds on each table (course). The average number of hits for each of the weapon groups is given in Table 4-9. These results are not comparable because firing conditions for the various groups differed. The RPD and DPM were fired with bipods, and the others with tripods. The second M60 machinegun group and the second Stoner machinegun group consisted of retrained riflemen. This

**Table 4-5  
AUTOMATIC RIFLE  
DISASSEMBLY AND ASSEMBLY TESTS**

<b>Weapon</b>	<b>Test</b>	<b>Average Disassembly Time (Seconds)</b>	<b>Average Assembly Time (Seconds)</b>
<b>M14E2</b>	<b>1</b>	<b>42</b>	<b>59</b>
	<b>2</b>	<b>29</b>	<b>55</b>
	<b>3</b>	<b>27</b>	<b>58</b>
	<b>4</b>	<b>26</b>	<b>50</b>
<b>Colt AR</b>	<b>1</b>	<b>59</b>	<b>108</b>
	<b>2</b>	<b>39</b>	<b>72</b>
	<b>3</b>	<b>36</b>	<b>56</b>
	<b>4</b>	<b>34</b>	<b>61</b>
<b>Stoner AR</b>	<b>1</b>	<b>151</b>	<b>207</b>
	<b>2</b>	<b>117</b>	<b>178</b>
	<b>3</b>	<b>103</b>	<b>154</b>
	<b>4</b>	<b>53</b>	<b>104</b>
<b>Stoner Bipod MG (AR role)</b>	<b>1</b>	<b>162</b>	<b>263</b>
	<b>2</b>	<b>124</b>	<b>185</b>
	<b>3</b>	<b>69</b>	<b>164</b>
	<b>4</b>	<b>56</b>	<b>109</b>
<b>RPD (AR role)</b>	<b>1</b>	<b>43</b>	<b>124</b>
	<b>2</b>	<b>33</b>	<b>90</b>
	<b>3</b>	<b>28</b>	<b>75</b>
	<b>4</b>	<b>31</b>	<b>78</b>
<b>M60 MG (AR role)</b>	<b>1</b>	<b>62</b>	<b>90</b>
	<b>2</b>	<b>52</b>	<b>96</b>
	<b>3</b>	<b>43</b>	<b>75</b>
	<b>4</b>	<b>41</b>	<b>75</b>
<b>RPD (AR role)</b>	<b>1</b>	<b>52</b>	<b>118</b>
	<b>2</b>	<b>42</b>	<b>70</b>
	<b>3</b>	<b>29</b>	<b>71</b>
	<b>4</b>	<b>25</b>	<b>72</b>

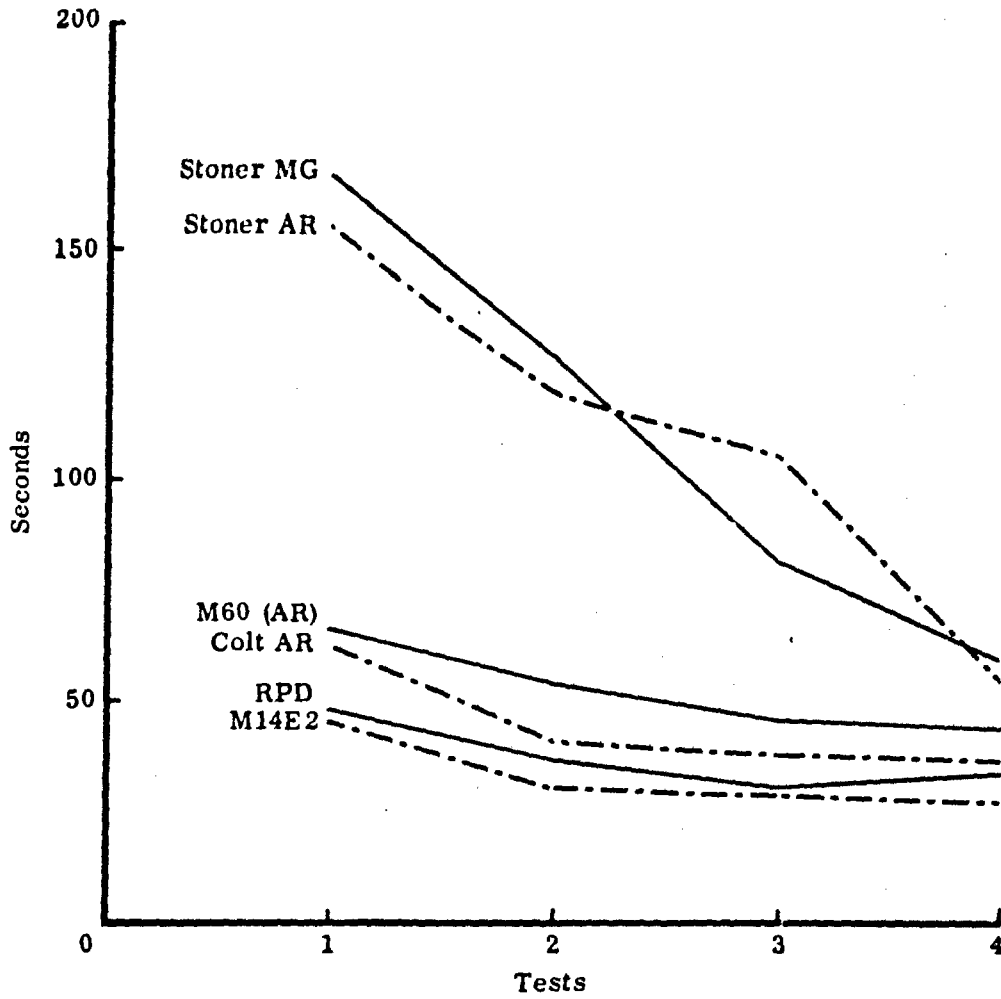

Figure 4-3  
DISASSEMBLY TIME OF AUTOMATIC RIFLES

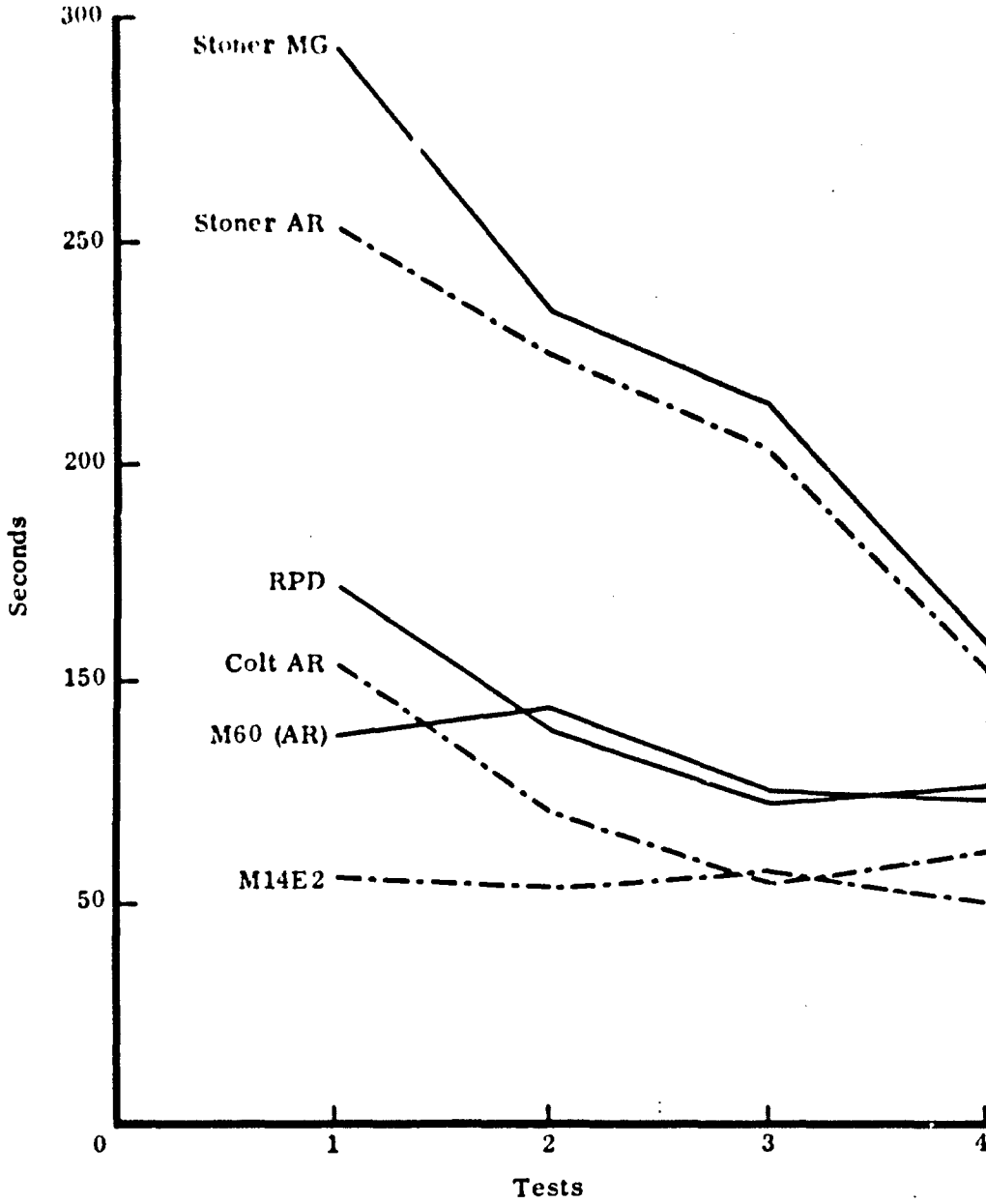

Figure 4-4  
ASSEMBLY TIME OF AUTOMATIC RIFLES

**Table 4-6  
AUTOMATIC RIFLE  
INTERIM TRANSITION RECORD**

Weapon	Average Hits	Average Targets Hit	N
Colt AR	30.69	11.25	16
M60 (AR role)	26.87	10.87	16
Stoner Bipod MG (AR role)	26.44	10.75	16
M14E2	25.53	10.46	13
RPD (AR role)	23.17	10.10	6
RPD (AR role)	22.00	10.00	10
Stoner AR	21.94	9.94	16

**Table 4-7  
AUTOMATIC RIFLE AVERAGE HITS  
UNDERARM (UNSUPPORTED) AND HIPSLING POSITIONS  
(25-meter Range)**

Weapon	Firing Positions		N
	Underarm	Hipsling	
Colt AR	2.88	1.94	16
M60 (AR role)	3.38	4.44	16
Stoner bipod MG (AR role)	3.75	3.75	16
M14E2	1.56	1.50	16
RPD (AR role)	2.50	3.83	6
RPD (AR role)	2.90	2.70	10
Stoner AR	4.21	3.71	14

**Table 4-8  
MACHINEGUN  
DISASSEMBLY AND ASSEMBLY TESTS**

Weapon	Test	Average Disassembly Time (seconds)	Average Assembly Time (seconds)
Stoner MG (bipod)	1	167	230
	2	138	168
	3	103	126
	4	109	148
Stoner MG (tripod)	1	168	246
	2	90	131
	3	100	134
	4	69	127
M60 MG (bipod)	1	89	115
	2	53	85
	3	46	71
	4	50	75
M60 MG (tripod)	1	95	131
	2	58	85
	3	49	73
	4	49	73
Stoner MG (bipod) Retrained Riflemen	1	113	195
	2	89	174
	3	78	159
	4	75	139
Stoner MG (tripod) Retrained Riflemen	1	99	159
	2	84	133
	3	70	127
	4	65	137
M60 MG (bipod) Retrained Riflemen	1	67	116
	2	70	107
	3	54	84
	4	55	85
M60 MG (tripod) Retrained Riflemen	1	78	106
	2	77	103
	3	54	84
	4	56	82
RPD	1	34	53
	2	35	54
	3	28	53
	4	25	39
DPM	1	68	128
	2	53	89
	3	42	87
	4	32	61

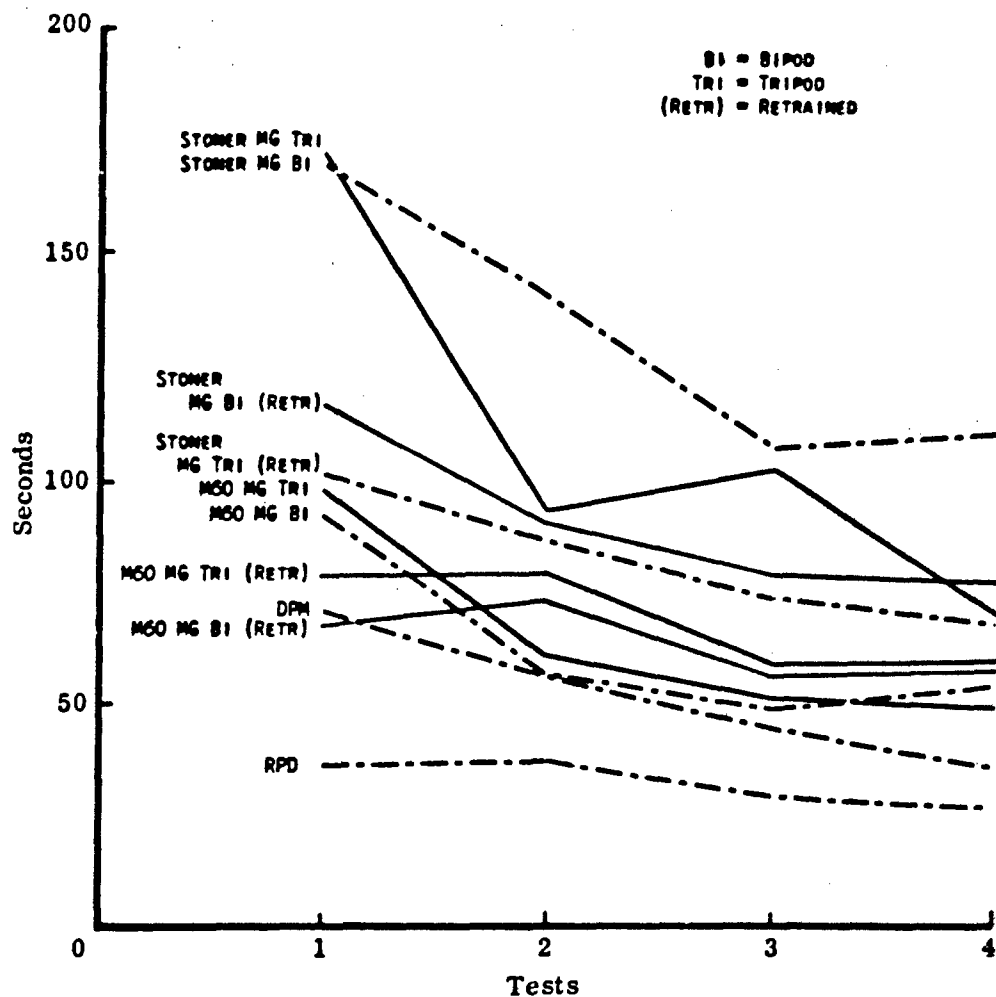

Figure 4-5  
DISASSEMBLY TIME OF MACHINEGUNS



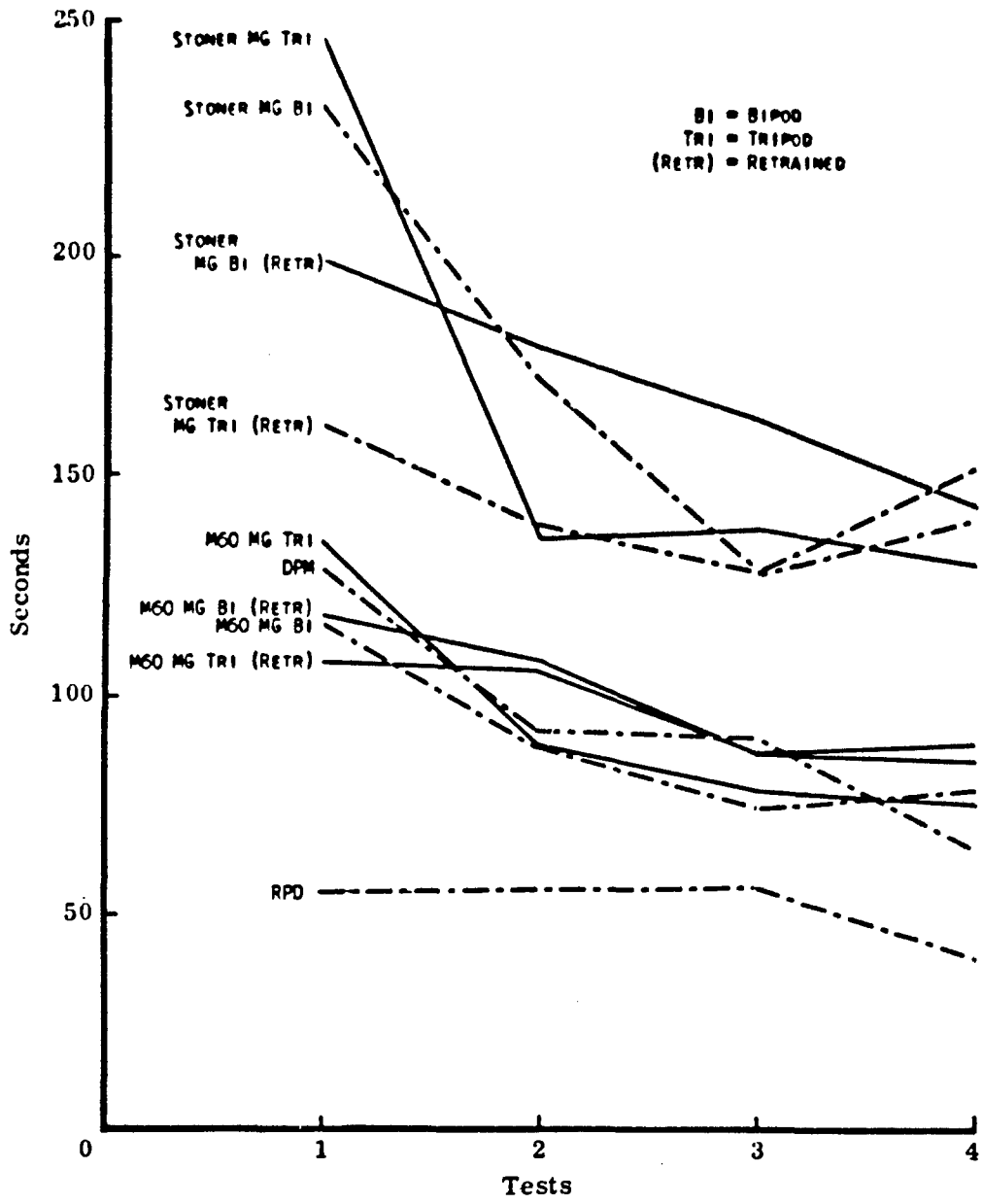

Figure 4-6  
ASSEMBLY TIME OF MACHINEGUNS

**Table 4-9**  
**MACHINEGUN TABLES II, III, IV**  
**AVERAGE NUMBER OF HITS**

Weapon	Table II	Table III	Table IV	N		
				II 32	III 35	IV 33
Stoner MG tripod	64.53	64.64	68.29			
RPD bipod	62.13	68.87	72.40	15		
M60 MG tripod	66.77	70.46	74.20	35		
DPM bipod	57.50	57.25	63.13	8		
M60 tripod Retrained Riflemen	67.33	69.29	75.02	48		
Stoner MG tripod (butt stock) Retrained Riflemen	72.96	73.09	74.38	47		

may have given them a special advantage. In addition, the second Stoner machinegun group fired with buttstocks attached.

**D. CONTAMINATION OF TRAINING SCORES BY WEATHER**

It was recognized before the experiment that weather conditions, particularly light conditions, would affect the firing scores. It was determined from exploratory firing runs with all weapons before the start of training, that these effects were particularly highly correlated with firings against visible point targets where aimed fire was involved, with minimal effects in those situations where area fire was employed.

It was possible during the experimentation runs on the three SAWS experimentation ranges to balance out the schedule of runs so that the same number of squads from each weapon mix ran the same number of times at each time of day. However, during the training phase due to constraints of time, the limited number of range personnel, and limited access to the Fort Ord Training Center ranges, it was not possible, except in rare instances, to balance out weather and time of day effects. Consequently, although training was standardized and although each group received equivalent amounts of training, the record firings on the record ranges are often not comparable.

The effects of time of day and position of the sun are illustrated in Figure 4-7 below. This figure shows the record firing scores of 11 consecutive firing orders of M14 riflemen, the first order having fired at 0800 in the morning and the last order at 1615 in the afternoon. The day was clear and sunny. At 0800 hours, however, for Order No. 1, the sun was in front of the firers, shining behind the targets and into the firers' eyes. On the 1230 hour run, however, the sun was behind the firers. Furthermore, the sun now shone on the front of the targets, and in many instances the targets reflected the sun like a mirror. The difference between the average scores for mixed firing at different times of day was sometimes greater than the difference between the best and worst men within each group. Thus, the difference between the average score of Order No. 1 (37.6) and Order No. 10 (50.8) may not be attributed to any difference in marksmanship ability, but instead must be attributed to differences in visual target acquisition resulting from the position of the sun.

In contrast to Range 19, the effects of visibility on Range 18 are illustrated in Figure 4-8 below. At 0800 hours it was too foggy to see the targets. By 0930 hours, it had cleared enough for range personnel to see the targets and firing was started, but thin fog and haze were still present. The day steadily cleared until for the fourth AK47 order at 1155 hours, all haze had disappeared, and the day was clear and sunny with unlimited visibility.

Following the completion of basic marksmanship training, rifle and machinegun squads were given separate transition training as explained in Section II, paragraph 4B2. The ranges on which this training occurred are presented as follows in diagrammatic form, Figures 4-9 through 4-15.

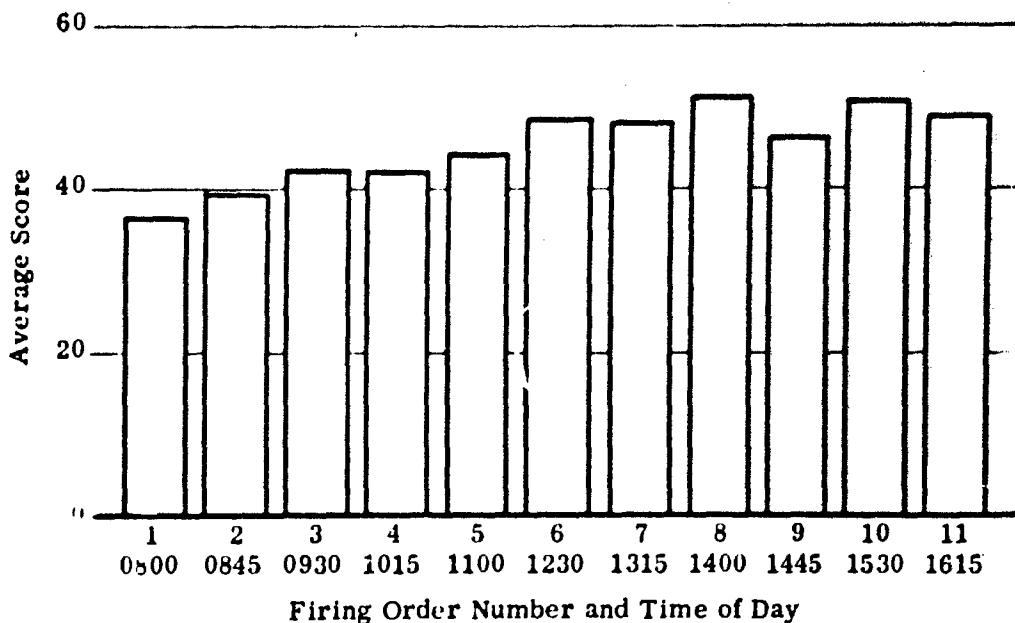

Figure 4-7 RANGE 19 RECORD SCORES AS A FUNCTION OF TIME OF DAY (Position of Sun)

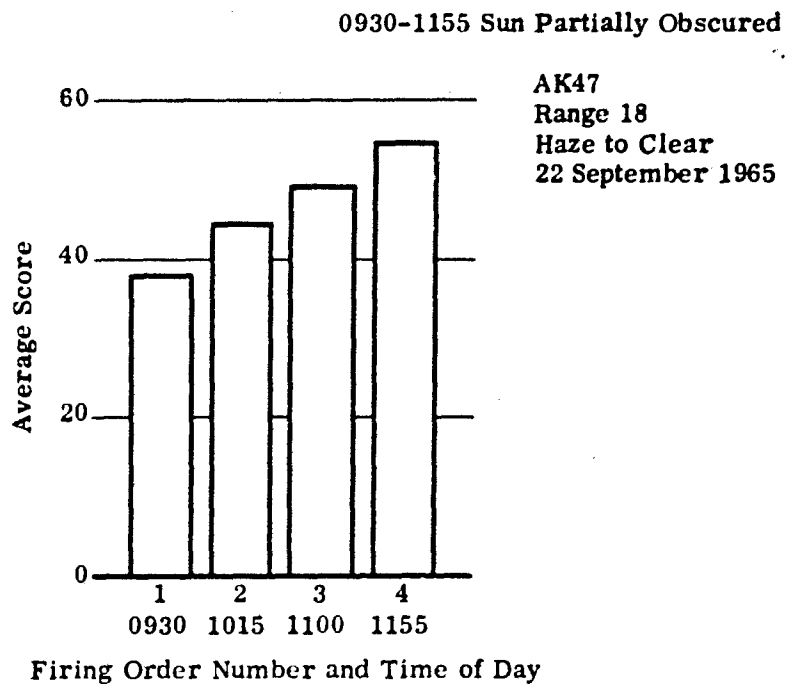

Figure 4-8 RANGE 18 RECORD SCORES AS A FUNCTION OF HAZE CONDITIONS

Rifleman: 10 Rounds  
Automatic Weapons: 20 Rounds

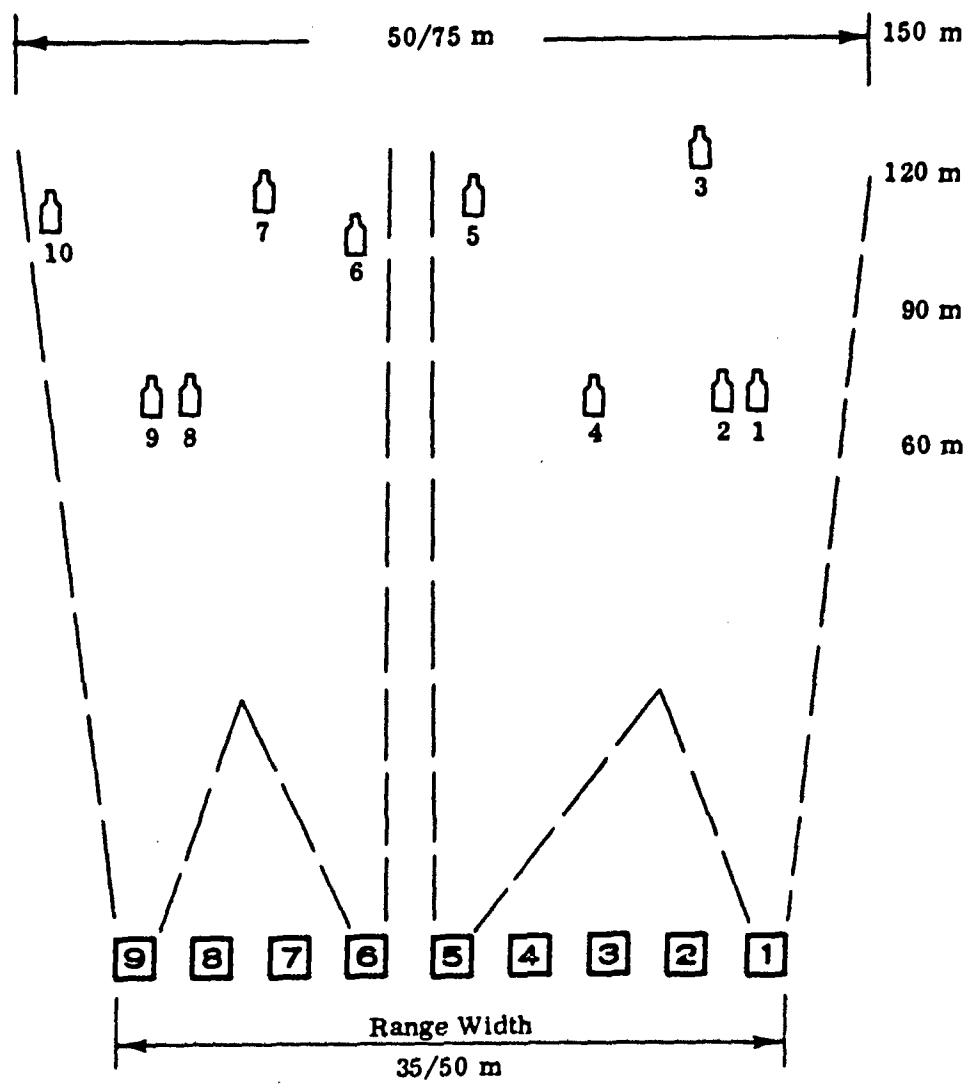

Figure 4-9  
RIFLE SQUAD TECHNIQUE OF FIRE RANGE (Linear Targets)

Rifleman: 10 Rounds  
Automatic Weapons: 20 Rounds

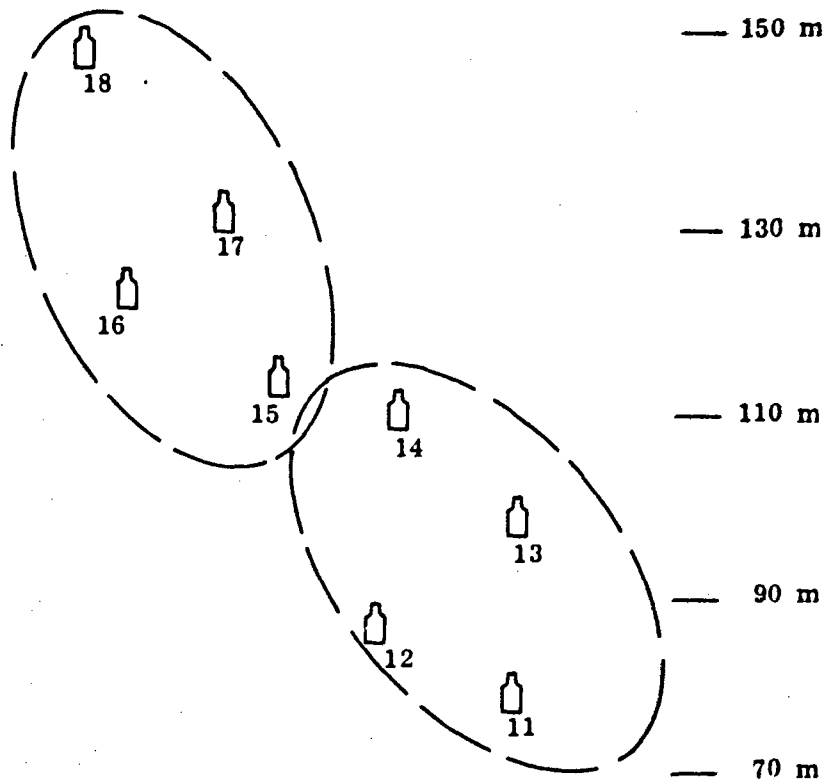

Figure 4-10  
RIFLE SQUAD TECHNIQUE OF FIRE RANGE (Oblique Targets)

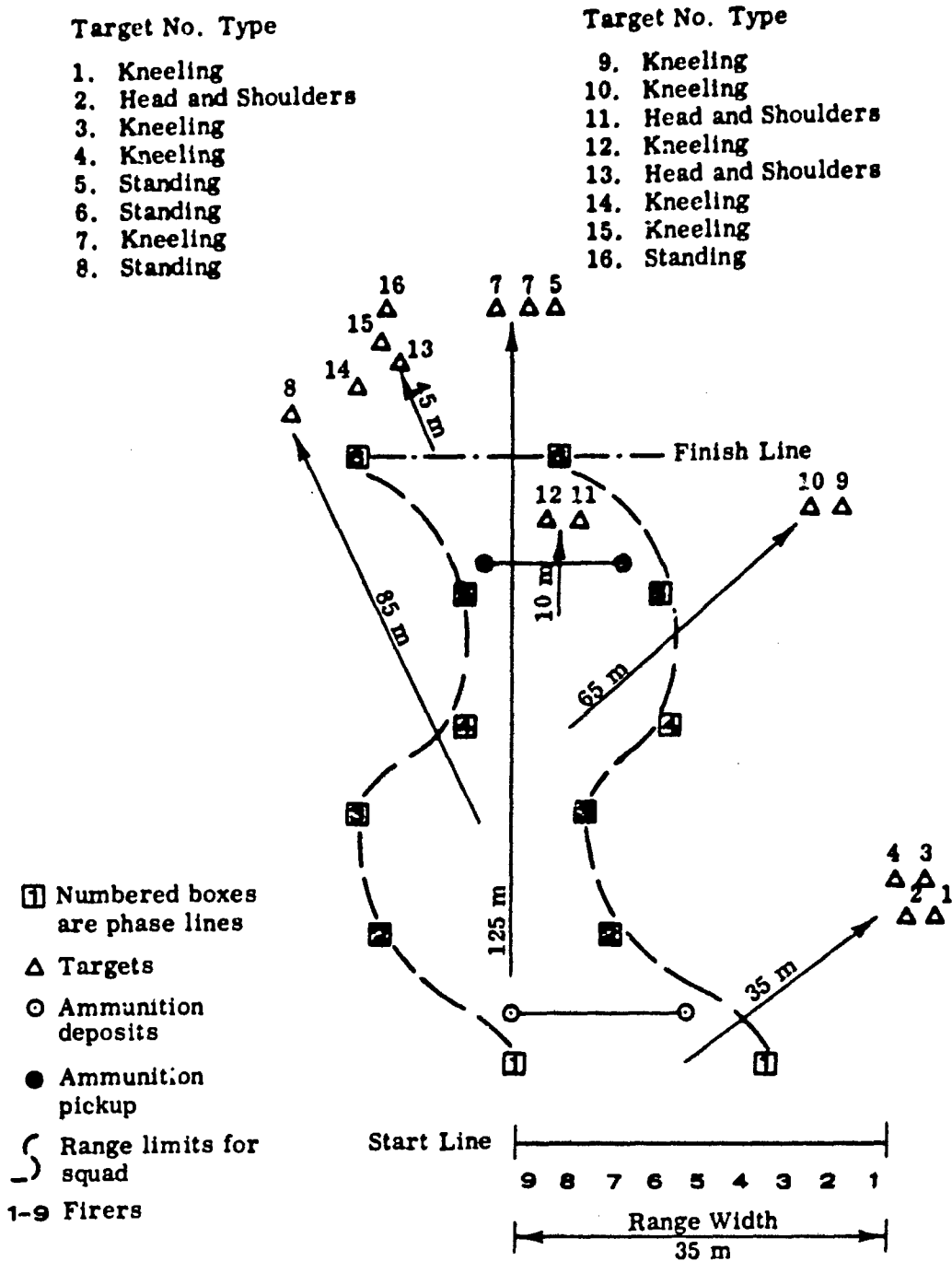

Figure 4-11  
RIFLE SQUAD IN APPROACH TO CONTACT RANGE

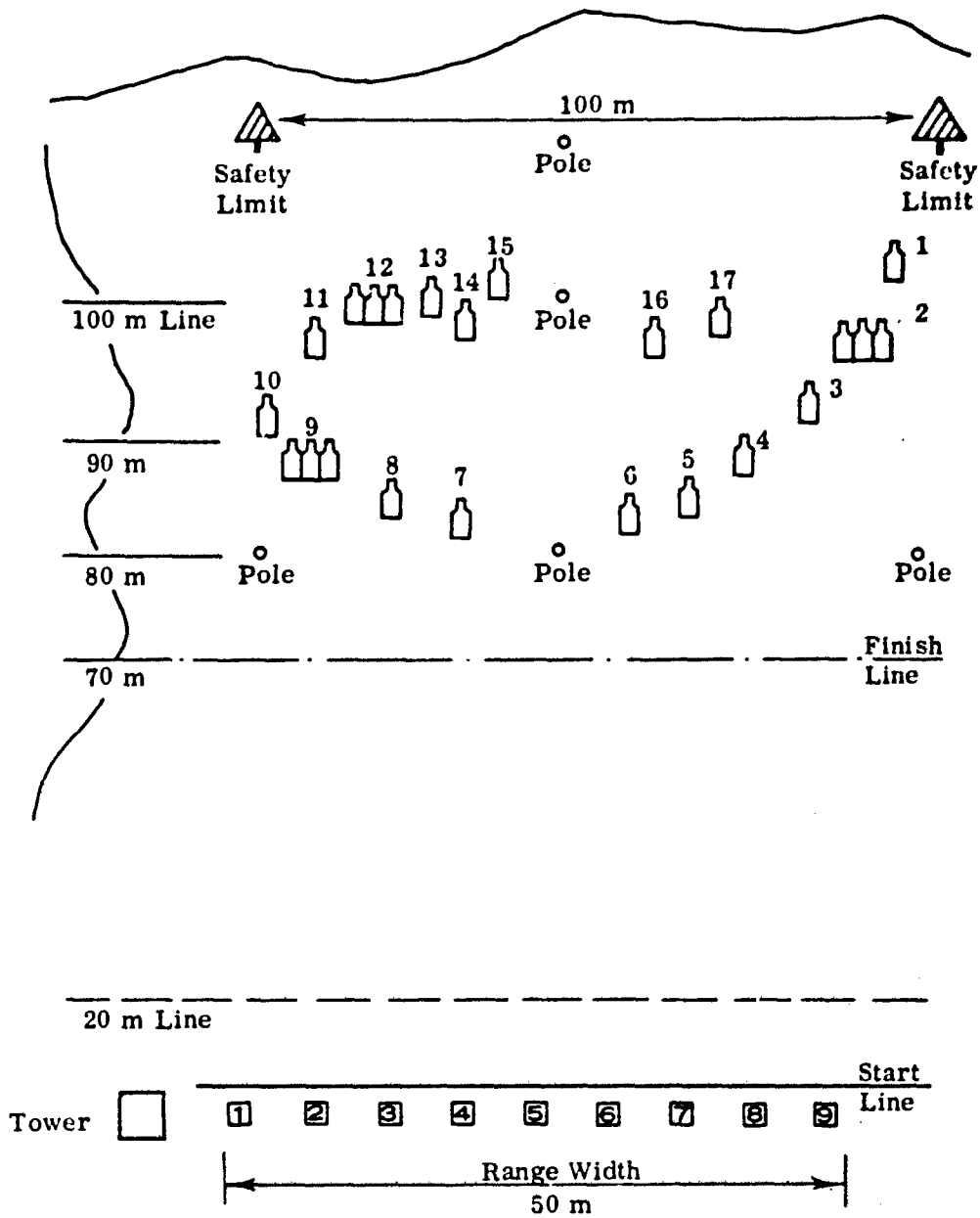

Figure 4-12  
RIFLE SQUAD IN ASSAULT RANGE



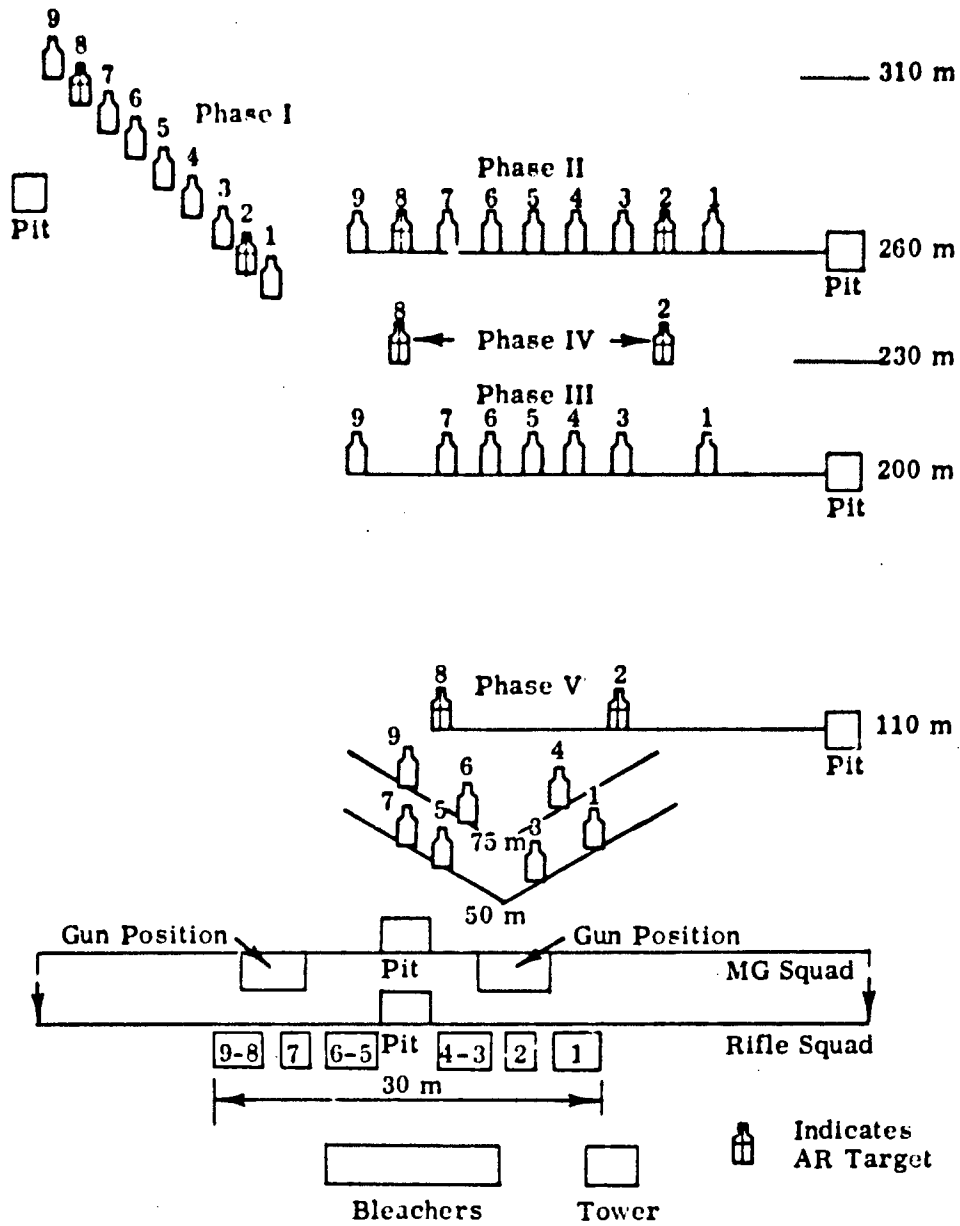

Figure 4-13  
SQUAD IN DEFENSE RANGE (Rifle or Machinegun)

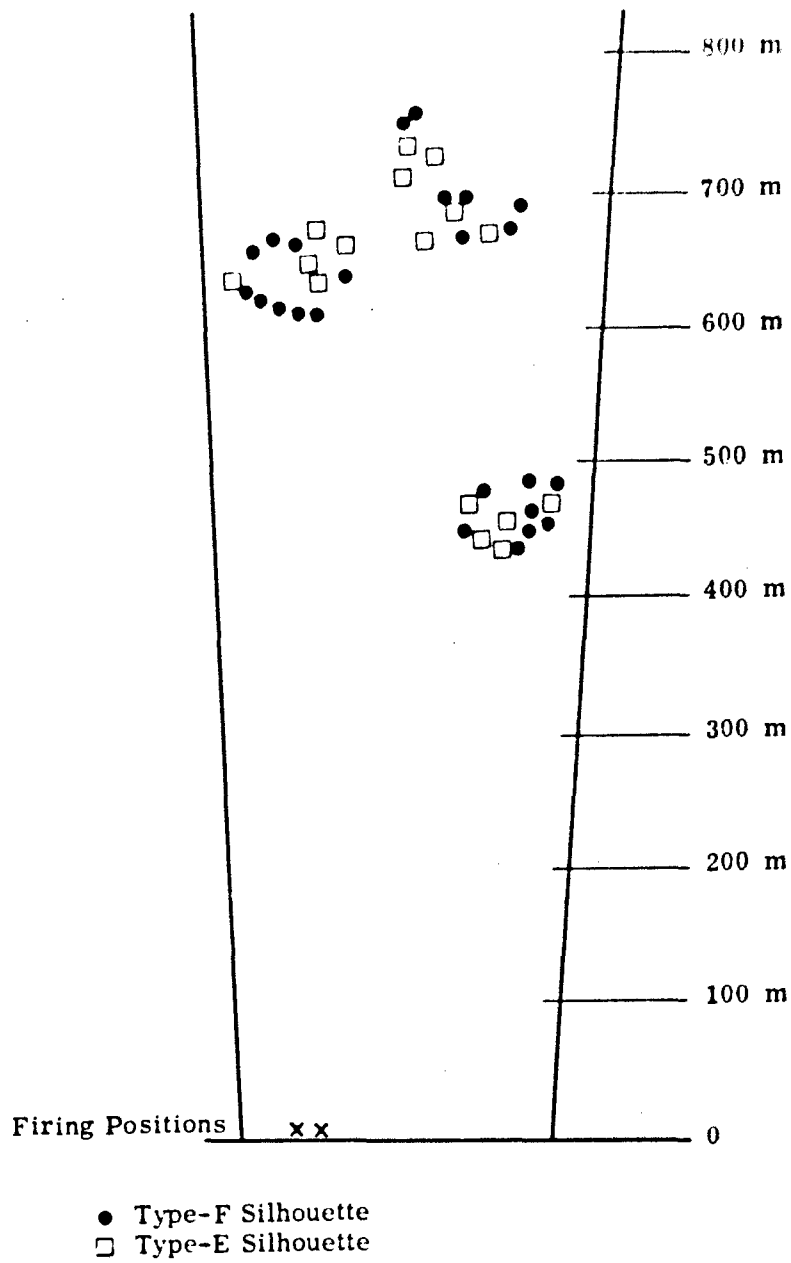
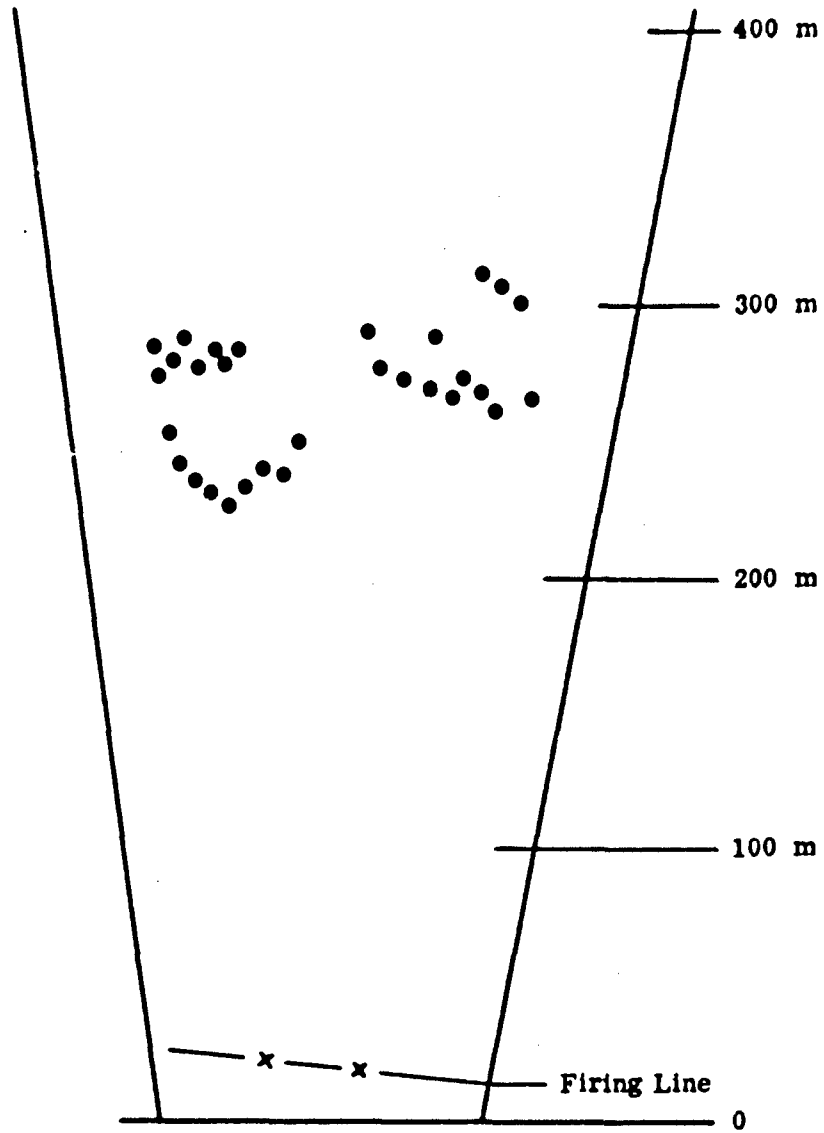

Figure 4-14  
MACHINEGUN SUPPORT OF ATTACK RANGE



● Type-F Silhouettes  
x Firing Position

Figure 4-15  
MACHINEGUN SUPPORT OF ASSAULT RANGE

## SECTION V

### MATERIEL RELIABILITY RESULTS

Reliability results are based on data recorded during training, exploratory, and field experimentation firing (Table 5-1), on investigations made to isolate major causes of malfunctions affecting the experiment, and on observations by technical personnel supervising weapons.

Included are indications of the purpose of reliability data, types of data, methods of collection, and results, including the major causes of malfunctions in certain weapons and the effects of materiel reliability on other results of the experiment.

#### A. PURPOSE OF RELIABILITY DATA

Reliability data were collected and observations were made for the following reasons:

- 1) To meet requirements of the USACDC directive which specified that reliability data be collected
- 2) To provide information and data that would assist in interpreting fire effectiveness data obtained in the experiment; for example, to obtain an indication of the effects of weapon stoppages occurring during the experiment on the level of target effects achieved by different squad weapon mixes
- 3) To assist in making judgments within the SAWS program, regarding the relative reliability of experimentation weapons as to whether there are any fundamental design reasons that might cause one weapon to be less reliable than another\*

---

\* The weapons should not be directly compared on the basis of current reliability performance, because they represent different stages of development and of production experience. For example, the AK47 has been standardized for 18 years and probably more than 15 million have been produced. The M14 has been standardized for eight years and about 1,400,000 have been produced. The M16E1 and M16 have been standardized about two years and about 173,000 have been produced for US military forces. This figure does not include production for foreign or commercial customers. The Colt automatic rifle is a developmental weapon, although an adaptation of the M16E1; and the Stoner weapons are test prototypes.

- 4) To provide detailed reliability data for development, procurement, and logistic agencies for such use as they may have.

## B. DATA COLLECTED AND OBSERVATIONS

Detailed reliability data were collected throughout the SAWS experiment--in the training phase, during exploratory firing, and in field experimentation. These data related to malfunctions, time out of action because of stoppages, and replacements of parts and accessories. They were recorded to relate weapon, firer, ammunition lot, weapon zero, rounds fired, trial and trial conditions, and date. Functioning of the weapons and ammunition was also closely observed by supervisory personnel. An attempt was made throughout the experiment to isolate major causes of materiel malfunctions. An AMC technical representative was attached to USACDCEC throughout.

Technical weapon officers and trained armorer artificers supervised the security, safety, maintenance, issue, and troop cleaning of weapons, as well as the storage, inspection, loading of magazines and belts, and issue of ammunition. Weapons were inspected at the time of issue to squads from the storage vans, at the range before the firing run, immediately after the run, after cleaning, and before they were stored again in the van. Two armorer artificers collected reliability data during each squad firing run and debriefed each squad immediately after the run for additional information on malfunctions.

The candidate weapons, ammunition, and spare parts for the experiment were selected and provided by AMC. The weapons, except for the Soviet-types, were in new condition when received by USACDCEC. The ammunition lots provided for the candidate weapons were selected by AMC as typical of ammunition in stock. The Soviet-type weapons were not new, were manufactured in several countries, did not have spare parts (other than by cannibalization), and used a variety of ammunition of varying condition and serviceability.

Data were taken during the experiment on bench rest accuracy of a sample of each weapon-ammunition combination. A summary of these data is given in Annex C.

## C. RELIABILITY RESULTS AND FINDINGS

Summary data on malfunctions and stoppages are shown in Table 5-1, by weapon family, weapon, and experiment phase. Further summary of these data, showing malfunctions per thousand rounds fired for each type weapon for the entire experiment and for the field experimentation only, is presented in Table 5-2.

Table 5-1 MALFUNCTIONS A

Malfunctions and Straggles	U.S. Weapons Family									Civil Weapons Family					
	M14			M14E2			M16			M16E1			Auto Rifle		
	A	B	C	D	E	F	G	H	I	J	K	L	M	N	O
	Trg	Expl	Expn	Trg	Expl	Expn	Trg	Expl	Expn	Trg	Expl	Expn	Trg	Expl	Expn
1 Failure to feed	4	11	74	1	2	25	1	3	12	44 <sup>b</sup>	33	199	16	7	120
2 Failure to eject		1	3			1	1	4	46	120	94	1510	2	15	37
3 Failure to extract	1	1	3	1		3	1	4	4	3	27	222		6	1
4 Failure to fire <sup>a</sup>	1	9	66			11	2	1	16	4	33	846		99	143
5 Failure of bolt to remain at rear after firing last round in magazine	2			2	3	2		4		59	169	94	2	21	9
6 Failure of bolt to seat off															
7 Short event										3					
8 Bolt overrode base of round in magazine			2						3	2					
9 Double feed										40 <sup>c</sup>	24	267	14 <sup>b</sup>	13	74
10 Failure of magazine to lock in rifle										3			1		
11 Failure to remain in assembly	3						9		3	1	1	6		2	
12 Partial stripping of round from link										2					
13 Failure of bolt to lock	1		4									16			1
14 Failure to chamber	3								1	1					4
15 Failure of bolt to go forward			3		2				4			9			
16 Failure of bolt to seat															
17 Bolt jammed	1														
18 Bolt overrode base of round in feeding			5								54	119		23	27
19 Link belt separation									3	11					
20 Failure on closure of bolt			3			2							4		5
21 Bolt catch engaged before last round in magazine was fired			1										4		
22 Total Malfunctions	16	22	164	4	7	44	14	31	104	354	457	2476	55	226	631
23 Total Rounds Fired: Trg Expl Expn	156,549	47,449	116,049	14,165	14,964	79,534	170,336	61,945	95,401	105,313	66,422	265,557	15,324	24,519	104,744
24 Total Rounds Fired <sup>b</sup>	320,527			116,667			327,722			437,692			142,675		
25 Malfunctions per 1000 rounds	.10	.46	1.41	.22	.37	.55	.04	.50	1.09	3.40	6.94	9.32	2.63	9.20	4.30
26 Number of weapons used	120	59	120	22	33	64	44	21	40	120	35	120	16	17	16
27 Average number of rounds fired per weapon	1305	812	964	426	575	1243	1471	2932	2345	474	1909	1213	413	1445	6549

NOTE: Some training and exploratory firing was concurrent with field experimentation.

Trg: Training  
Expl: Exploratory Firing  
Expn: Field Experimentation

<sup>a</sup> Most misfires with U.S. weapons apparently were due to the ammunition.

<sup>b</sup> Eighty-two failures to feed were not attributable to the weapons (they were caused by magazine lips bent in a magazine loader designed for another weapon).

**PPAGES OF WEAPONS**

Stinger Weapons Family								Rocket-Type Weapons								
Virt Rifle				M1				AK47			RPD MP			DPM MP		
R	S	T	L	V	W	X	Y	Z	71	72	73	74	75	76	77	
Expn	Tng	Expl	Expn	Tng	Expl	Expn	Tng	Expl	Expn	Tng	Expl	Expn	Tng	Expl	Expn	
29	3	3	4	27	27	21			24			49		19	114	
44	2	4	3	5	35	71		1	7						4	
49	2	7	1	17	26	138	3	1	74		2	7			4	
57		14	26	73	291	764	4	5		2	2	24	1	135 <sup>a</sup>	43	
90																
		1														
				1		40								1		
		9	16	100	24	47			2						4	
111	1	1	4									1				
							2									
		1		9		3										
						32				4						
7						2			2							
4	2	1	1	1		5		1	1		3				17	
9				53	4	12						1	2			
		4												1		
29																
				143	339 <sup>b</sup>	212 <sup>c</sup>					1	1				
4																
457	12	45	64	549	774	1349	9	4	112	6	10	43	4	149	242	
150,000	13,371	23,342	19,994	122,002	44,922	41,642	84,704	14,091	55,041	54,614	1,424	22,143	14,364	2,302	12,042	
	56,907			252,546			171,476			40,225			28,704			
1.01	.90	1.91	3.30	4.50	15.42	16.52	.09	.44	2.03	.11	7.00	3.74	.24	64.73	20.10	
1.0	16	17	16	44	19	40	26	10	26	7	4	7	3	3	3	
1257	430	1345	1250	2773	2575	2042	3796	1409	2119	4044	337	3149	4754	767	4014	

<sup>a</sup> rounds of fires not removing magazine when late action.

<sup>b</sup> Includes 47 instances of bad primers in ammunition.

<sup>c</sup> Due to faulty manufacture of belt links.

<sup>d</sup> rounds of fires not removing magazine when applying

<sup>e</sup> Total rounds fired for the experiment: 2,306,940 with experimentation weapons (an additional 542,547 rounds were expended in nonexperimentation firing).

Table 5-2  
MALFUNCTION RATES

Weapons <sup>A</sup>	Number of Weapons Used	Malfunctions per 1000 Rounds Fired		Average Number of Rounds Fired per Weapon	
		Total Experiment <sup>B</sup>	Field Experimentation Phase	Total Experiment <sup>C</sup>	Field Experimentation Phase
<u>Rifles</u>					
M14	120	0.63	1.41	3,085	968
M16E1	120	7.50	9.32	5,000	2,213
Stoner Rifle	120	1.90	3.03	5,127	1,257
AK47 <sup>D</sup>	26	0.75	2.03	7,724	2,119
<u>Automatic Rifles</u>					
M14E2 <sup>E</sup>	64	0.47	0.55	2,644	1,243
Colt AR	16	4.99	4.30	8,827	6,549
Stoner AR	16	2.16	3.30	3,471	1,250
<u>Machineguns</u>					
M60 MG	40	0.46	1.09	9,208	2,385
Stoner MG	40	10.58	16.52	7,390	2,042
RPD	7	1.23	3.74	11,614	3,169
DPM	3	13.76	20.10	9,569	4,014

<sup>A</sup> All weapons provided for the experiment were new, except the Soviet weapons

<sup>B</sup> Training phase, exploratory firing, and field experimentation

<sup>C</sup> The average number of rounds fired per weapon during the training, exploratory firing, and field experimentation phases

<sup>D</sup> The majority of the AK47 malfunctions occurred after 5000 rounds had been fired during the experiment. Thirteen weapons averaged more than 10,000 rounds apiece. In addition an unknown number of rounds had been fired from the weapons before they were forwarded to USACDCEC. However, the AK47 had significantly fewer malfunctions per weapon than any other weapon at the time it had fired a comparable number of rounds during the experiment.

<sup>E</sup> Includes use as a rifle



Comparative data on parts attrition are shown in Tables C-8 through C-21, Annex C.

The following findings are drawn from the results presented in Tables 5-1, 5-2, and Annex C, with respect to the level of reliability demonstrated in the experiment by candidate and Soviet weapon-ammunition combinations:

- 1) The AK47 was more reliable than any of the other experimentation weapons\*
- 2) The M14, M14E2, and M60 were more reliable than the Stoner and Colt Weapons
- 3) The Stoner machinegun and M16E1 showed the lowest reliability of the candidate weapons
- 4) The Stoner machinegun was least reliable of the candidate weapons, the remaining Stoner weapons ranked after the US 7.62mm weapons but ahead of Colt weapons in reliability

Causes of the principal malfunctions in the weapons are discussed in the following paragraphs.

\* The AK47 averaged 0.75 malfunctions per 1000 rounds fired throughout the entire experiment, based on 26 weapons used after January 1966. However, the majority of firing with the AK47 was done prior to 24 December 1965 with 13 weapons which averaged only .30 malfunctions per 1000 rounds while averaging 8007 rounds fired per weapon at that time. The AK47s were not new, had been manufactured in three different countries (the Soviet Union, East Germany and Red China) and had unknown prior combat and training usage. In addition, there were insufficient spare parts (of the 29 available weapons three were used for spare parts). This lack of weapons and spare parts required an extensive sharing of the AK47s which had an overall average rounds fired of 7724 rounds during the entire experiment compared to only 3085 rounds for the M14. However, the average for the original 13 AK47s was 10,926 rounds per weapon. Although the M14 malfunction rate was 0.63 (0.12 malfunctions per 1000 less than the AK47), many of the M14s had parts replaced with new parts whereas the AK47s were forced to use worn and theoretically unserviceable parts. However, all parts replaced (with used parts from other weapons) were in the original 13 AK47s, and in only one case was a part replaced under 7500 rounds. Because the majority of AK47 malfunctions occurred after 5,000 rounds had been fired and because the weapons had fewer malfunctions per 1,000 rounds when compared with the M14 at the same number of rounds fired, it is concluded that the AK47 is a significantly more reliable weapon than any of the US 7.62mm or 5.56mm weapons.

1. Major Causes of Malfunctions in US 7.62mm Weapons

There were few malfunctions in the US 7.62mm weapons. The 74 failures to feed (Table 5-1, line 1, Column C) in the M14 rifle were attributed to dirty magazines and the magazine follower sticking (through distortion of the magazine spring). The 66 failures to fire were the result of light firing pin indentations in the primer that were considered to be the result of weapons not being completely in battery on activation of the trigger.

2. Major Causes of Malfunctions in 5.56mm Weapons\*

Major causes of most malfunctions in the 5.56mm weapons are attributed to an interaction of ammunition (and belt link) deficiencies:

- 1) Weapon fouling, judged to be caused primarily by qualities of the propellant used in standard ball 5.56mm cartridge
- 2) Cycling of weapons in excess of design rates, judged to be caused by combinations of\*\*:
  - a) Pressure characteristics of the propellant used in the standard ball 5.56mm cartridge
  - b) Factory calibration of M16E1 rifles for a propellant with different pressure characteristics than that in the standard ball 5.56mm cartridge
  - c) Mismatch in internal ballistic (pressure) characteristics between the standard 5.56mm ball and tracer cartridges
- 3) Misfires caused by too low primer sensitivity and possibly (in the case of the Stoner machinegun) an interaction of low primer sensitivity with effects of too rapid weapon cycling caused by the pressure characteristics of the propellant

\* These major causes do not account for all the malfunctions experienced by the 5.56mm weapons. For example, early in the experiment the Stoner machinegun had malfunctions caused by improperly fabricated feed trays that were replaced. Accurate attribution of causes for all malfunctions is difficult because some ammunition deficiencies magnified incipient malfunctions.

\*\* Cyclic rates (upper limit) for the M16E1 rifle and Stoner machinegun are 800 and 850 rounds per minute respectively.

- 4) Incorrectly manufactured machinegun belt links
  - a. Fouling

Fouling in the 5.56mm weapons occurred throughout the experiment. Dirty chambers resulting from rapid carbon buildup caused most of the failures to extract (see Table 5-1, line 3, columns J through X) and some of the failures to chamber (line 14). Fouling remained a problem throughout the experiment, although cleaning and inspection of weapons were considered more stringent than would be possible during combat.

Inquiry to AMC determined that the propellant adopted for the standard 5.56mm ball cartridge is different from the original propellant used during the development and service testing of the M16E1 rifle and during the development of the Stoner weapons.\* A USACDCEC test of samples from the lot of standard ammunition used in the experiment showed more fouling than an AMC provided sample containing the original propellant. This supplemental fouling test was conducted using ammunition lots WCC 6098 and RA 5074. This limited test firing of 12,620 rounds indicated a malfunctions rate of 5.6 per 1000 rounds for the cartridge loaded with ball propellant as opposed to 0.91 for IMR propellant loaded cartridges. Results of this fouling test are tabulated in Annex C.

- b. Excessive Cyclic Rate

Excessive cyclic rates were noted early in the experiment. In addition, surging (uneven firing) was noted when ball and tracer were fired together. There was also an increasing incidence of malfunctions attributed to ammunition cycling the weapons beyond their design rates. The cyclic rates were higher than the design cyclic rates, particularly with the M16E1 rifle and Stoner machinegun.\*\* Surging also was most noticeable with the Stoner machinegun. It is concluded that this excessive cyclic rate (through induced cyclic and impact problems\*\*\*) caused, complicated, and multiplied such malfunctions as failures of the bolt to remain to the rear after the last round was fired from the magazine (see Table 5-1, line 5, columns J through X), failures to eject (line 2, columns J through X), and magazine feeding problems (lines 1, 9, and 18).

---

\* Frankford Arsenal, Tenth Memo Report on AR-15, Rifle/Ammunition System Investigation of Alternate Propellants for Use in 5.56mm M193 Ball Ammunition, dated 15 May 1964

\*\* Cyclic rate of up to 1000 rounds per minute

\*\*\* Impact forces increase with the square of the velocity

A concurrent propellant investigation by Frankford Arsenal showed that the propellant currently used in the 5.56mm ball cartridge cycles weapons faster than the original propellant.\*

Inquiry to AMC determined that, to meet a Government acceptance requirement, M16E1 rifles are calibrated at the factory for the gas port pressure of the original propellant rather than that of the propellant currently used in standard ball 5.56mm cartridges. Interaction of the higher gas port pressure of the current propellant and the sizing of the gas port for a propellant with a lower gas port pressure is considered the reason for the excessive cyclic rate in the M16E1 rifle.

Regarding the excessive cyclic rate and surging of the Stoner machinegun, it was noted that the 5.56mm tracer and ball rounds contained different propellants\*\* and cycled the 5.56mm weapons at different rates: tracer cartridges cycled the weapons at a slower rate than the ball cartridges. It is judged that because of this mismatch the gas port on the Stoner machinegun had to be sized for the slower cycling tracer cartridge to ensure weapons functioning. Since machinegun belt loadings normally are four ball and one tracer, the presence of the faster cyclic ball cartridges causes the gun to cycle above its design rate and to surge as the four faster and the one slower cartridges alternate through the gun. This mismatch also affects the functioning of the other 5.56mm weapons in automatic fire, but to a lesser extent than the machinegun, apparently because of the sustained automatic fire and more frequent use of tracers by the machinegun.

c. Primer Sensitivity

It was reported in a previous test of the Stoner weapons that there had been a high incidence of misfires, particularly in the machinegun\*\*\*. These misfires were attributed by some to an insufficient primer sensitivity of the 5.56mm cartridge and by others to a lack of sufficient recoil power in the Stoner machinegun. However, if these misfires were due to insufficient recoil power and if the sensitivity of the cartridge primer was not marginal, then misfires with the 5.56mm cartridge would tend to be limited to the machinegun. This was not the case in the SAWS experiment. After

\* USACDC Liaison Office, USA Weapons Command, Rock Island, Illinois, Liaison Report 385-65, 27 December 1965.

\*\* Copies of Ammunition Lot Inspection sheets furnished by AMC to USACDCEC to show that the ball ammunition furnished contains ball propellant (WC846) and that the tracer ammunition furnished contains IMR type propellant (CR 8136 and EX 8136).

\*\*\* Stoner 63 Weapon System Final Report, Project No. 44-63-08 of 29 April 1965, Marine Corps Landing Force Development Center, MCS, Quantico, Virginia, page 17.

It was decided that the ammunition was causing the machinegun to misfire and cycle at an abnormal rate, it was also decided that a reduction in the buffer preload resulting from the pounding of the buffer might reduce firing pin energy. It was indicated that this in turn might cause the rate of misfires to increase sharply after the weapons had been fired in heavy sustained fire, especially if primer sensitivity were marginal. Inquiry to AMC disclosed that there had been a decrease\* in primer sensitivity at the time of standardization of the 5.56mm ball cartridge, to overcome what was then considered a tendency of the round to fire on closure of the bolt in the M16E1 (then AR15) rifle. It was therefore desirable to examine the primer indentations of misfire cartridges. Therefore, provisions also were made to collect data regarding any instances of primers being too sensitive: that is, rounds firing when the bolt was closed without pulling the trigger. With respect to these points, the experiment produced the following information:

- 1) In 1,261,215 rounds fired by the 5.56mm weapons, there were no instances of cartridges firing when the bolt was closed without pulling the trigger and no cases where the primer indentations of misfire cartridges were sufficiently shallow to have clearly caused misfires.
- 2) Misfires occurred with all five of the 5.56mm weapons (see Table 5-1, line 4, columns J through X), rather than only with the Stoner machinegun. The four weapons other than the machinegun incurred 829 misfires in 1,008,629 rounds fired, or one per 1217 rounds.
- 3) Of the 1132 misfires experienced with the Stoner machinegun during the experimentation, 472 occurred during later sustained machinegun fire (Situations 3, 6, and 9). This could have been due to the reduction in the buffer preload, to the reuse of the belt links, or to some other cause. Measurements of the buffer taken after the completion of Situations 3, 6, and 9 showed that preloads were below the design minimum.\*\*

---

\* Primer sensitivity was decreased from "no fire" at 6 inch-ounces and "all fire" at 36 inch-ounces, to "no fire" at 12 inch-ounces and "all fire" at 48 inch-ounces. Ref: Frankford Arsenal - 1st Memo Report on AR15 Rifle Ammunition Systems, Investigation of Firing Pin Energy and Primer Sensitivity, data 4 April 1963 and Military Specification MIL-C-996-3D, dated 1 June 1964.

\*\* The preload specification is 245 pounds minimum and 260 pounds maximum. The average preload after firing Situations 3, 6, and 9, was 221 pounds.

This information therefore indicates that misfires in the 5.56mm weapons were due to the function of primers that were too insensitive.

d. Belt Links

During the experiment, it was noted that a major cause of Stoner machinegun malfunctions was belt link separations. Separations occurred as often as ten times per belt, frequently causing other malfunctions.

Comparisons of the links against design drawings showed that the links deviated from design drawings dimensions. At USACDCEC request, 30,000 links made to design drawing dimensions were obtained from AMC. A comparison test of the "old" and "new" links produced the following results.

An average of seven separations per belt occurred when eight belts of 150 rounds were fired, each using the old links. The number of separations by belt were 8, 3, 18, 5, 8, 0, and 7. These separations also caused 24 failures to feed, one failure to strip (stuffed round resulted), and two failures of bolt to go forward. No separations occurred with the new links when firing with seven 150-round belts and one 200-round belt. The 200-round belt had links that were used a second time.

The 30,000 links manufactured to proper design were then substituted for the originally supplied links for the machinegun squad portion of the experiment (Situations 3, 6, and 9). \* During this phase of the experiment (in which 28,000 rounds were fired) there were three belt separations, and these separations occurred with links that had been reused.

e. Other Ammunition Deficiencies

Although individuals adjacent to the firer normally could see both tracers, neither the US 7.62mm tracer cartridge nor the US 5.56mm tracer cartridge provided a trace that was visible enough to be used by the firer in adjusting fire, with or without sights, under daylight conditions. This deficiency negates the adjustment of fire for automatic weapons by the gunner observing his tracers.

The US 7.62mm duplex cartridge suffered pierced primers. This was judged to be caused by excessive chamber pressure. \*\*

---

\* Faulty type links already had been used with the Stoner machineguns throughout four of the six situations in the rifle squad portion of the experiment.

\*\* Current chamber pressure, temperature, and waterproofing deficiencies of this cartridge are given in Memorandum Report, Preproduction Test of Cartridge, 7.62mm, Ball, Duplex, M198, April 1965, Frankford Arsenal

#### **D. EFFECT OF MALFUNCTIONS ON EXPERIMENTATION**

Malfunctions in the 5.56mm weapons attributed to faulty ammunition and belt links degraded the fire effectiveness of all 5.56mm weapons, especially the M16E1 rifle and Stoner machinegun. In one tactical situation, for example, the M16E1 rifle had a weapon downtime due to stoppages of 6.97 percent of the situation time. The effects on the Stoner machinegun were judged to be sufficiently severe to disqualify the machinegun squad portion of the experiment.

The AK47 was the most reliable of the experimentation weapons. The US 7.62mm weapons (M14, M14E2, and M60) demonstrated fewer malfunctions than the US 5.56mm weapons. The Stoner machinegun and M16E1 had the highest malfunction rate. The reliability of the Stoner machinegun with the ammunition provided for the experiment was judged to be sufficiently low to invalidate the machinegun squad portion of the experiment. Major causes of malfunctions in the 5.56mm weapons were attributed to:

- 1) An interaction of ammunition deficiencies caused by changes made in the ammunition propellant and primer sensitivity at the time of the standardization of the 5.56mm ball cartridge
- 2) Deviations from design specifications in the manufacture of the machinegun belt links

Until the deficiencies in the ammunition and belt links are corrected (and it is considered that they are readily correctable), it is impossible for the Stoner 5.56mm machinegun to function at its maximum potential.

Neither 7.62mm nor 5.56mm tracer rounds provide a trace that is visible enough to the firer under daylight conditions for him to use it in adjusting his fire. The duplex round suffered pierced primers, apparently caused by excessive chamber pressure in the M14 and M14E2 rifles.

## SECTION VI

### SQUAD WEAPON MIX FIRE EFFECTIVENESS RESULTS

#### A. RIFLE SQUAD EXPERIMENT

The results are presented on foldout sheets and in separate tables and graphs for each situation. Included are raw score averages, standard scores, probability (p) values, F values,  $X^2$  values, ranges of scores for the measures of effectiveness and collateral measures, graphs of hits as a function of time and range where applicable, and histograms for the distribution of near misses by target where applicable.

The results for Mix RC (seven AK47 rifles and two RPD machineguns) are not included in the same tables and graphs as other mixes. Mix RC was fired later (January 1966). Because of differences in range conditions and weather, the RC results are not directly comparable to the other rifle squad mix results and are therefore presented separately.

##### 1. Situation 1: Rifle Squad in Line Assault

This situation evaluated rifle squad mixes in marching fire against concealed and partially concealed enemy targets in foxholes. The length of the assault was 100 meters, and the duration was 2 minutes. Enemy targets were engaged 115 to 148 meters from the line at which the assault started, and at distances of 15 to 48 meters from the point where the assault ended. The target array occupied a position 50 meters wide and 30 meters deep with a differential in target elevations of about 4 meters.

Results for the assault are tabulated and presented graphically in Figure 6-1.

The average number of near misses for all mixes combined are presented as a function of target location and simulator type in Figure 6-2. This figure presents the vertical profile of the target array showing to scale the elevation and width of the array. The position of each target is shown. Because the assault is progressing up a slope, the difference in the elevation of the actual targets as seen by the firers is less than that shown in the figure. The number associated with each target on the profile shows the average number of near misses for all rifle mixes, the simulator cues associated with each target, and the width of the near miss zone at each target. Although not shown, the height of the near miss sensing zone extends in a 2-meter semicircle from the center of the target.



The tabulation below indicates the approximate distance of the squad from the middle of the target array (in depth and width) in relation to the time in minutes that the squad progressed up the assault course. Exploratory firings on the assault range indicated that squad movement across the assault range was generally at a constant rate. All squads took approximately 2 minutes to complete the course.

Time Traveled (minutes)	Average Distance from Targets (meters)
.00	131
.25	119
.50	105
.75	94
1.00	81
1.25	69
1.50	56
1.75	44
2.00	31

Figure 6-3 illustrate the average number of targets hit and average number of near misses plotted as a function of time and range for each mix in the assault situation. The cumulative average hits by each mix at each point along the assault course are indicated by the ordinates of the curve at that point. The start of the assault (131 meters from the targets) is indicated by the left end of the curve and the completion of the assault (31 meters from the targets) is indicated by the right end of the curve.

Figure 6-4 shows the number of near misses for each target and their distribution as a function of target location and simulator type. Target locations are provided for purposes of comparison in insert maps.

The rank order of weapon mixes (other than Mix RC) with associated standard scores are presented below.

Target Effects Only			Overall Effectiveness*		
Rank	Mix	Standard Score	Rank	Mix	Standard Score
1	SB	70.1	1	CB	65.8
2	SA	68.9	2	SB	65.6
3	SC	65.2	3	SA	63.5
4	UB	59.8	4	CA	59.7
5	CB	57.9	5	SC	56.2
6	CA	47.1	6	UB	54.4
7	UA	42.2	7	UA	43.8
8	RA	35.7	8	RA	35.3
9	UD	28.2	9	UD	32.4
10	UC	25.9	10	UC	24.3

\* Sustainability weighted 1/3; Target effects 2/3

**Key:**

- |                                  |                                      |
|----------------------------------|--------------------------------------|
| UA - 9 M14 Rifles                | SB - 7 Stoner Rifles and 2 Stoner AR |
| UD - 9 M14E2 Rifles              | SC - 7 Stoner Rifles and 2 Stoner MG |
| UB - 7 M14 Rifles and 2 M14E2 AR | CA - 9 Colt Rifles                   |
| UC - 5 M14 Rifles and 2 M60 MG   | CB - 7 Colt Rifles and 2 Colt AR     |
| SA - 9 Stoner Rifles             | RA - 9 AK47 Rifles                   |

Mix RC results for Situation 1 are presented below.

CET	Near Misses	Percent Ammo Remaining	Targets Hit	Total Hits
29.08	3.67	25	2.4	2.4

EFFECTIVENESS MEASURES

COLLATERAL PERFORMANCE MEASURES

Cumulative Exposure Times				Number of Near Misses				Sustainability (% Ammo Remaining)						
A	Mix	$\bar{X}$ CET	SD	Standard Score z'	B	Mix	$\bar{X}$ Near Misses	SD	Standard Score z'	C	Mix	$\bar{X}$ % Remaining	SD	Standard Score z'
UB	24.1	2.4	81.8		SC	499.6	114.0	80.8		CA	72.2	5.2	85.0	
SB	24.4	1.7	73.4		SA	469.8	68.9	73.8		CB	69.9	3.5	81.4	
SA	24.8	1.9	64.1		SB	439.5	92.1	66.7		SB	52.8	6.0	56.4	
CB	25.1	2.0	56.3		CB	409.2	89.6	59.6		SA	51.1	8.2	52.7	
SC	25.3	2.1	49.6		CA	393.8	83.1	56.0		UA	47.5	6.7	47.3	
UA	25.5	1.2	47.2		RA	324.4	26.1	39.8		UB	45.2	11.9	43.8	
UD	25.5	1.9	44.8		UB	315.5	73.2	37.7		UD	43.4	10.3	41.0	
CA	25.8	1.4	38.2		UA	312.8	59.4	37.1		SC	41.3	8.3	37.8	
RA	26.1	0.8	31.5		UC	312.3	49.2	37.0		RA	39.2	2.9	34.6	
UC	26.8	2.4	14.9		UD	203.3	30.4	11.5		UC	30.3	9.5	21.0	
$\bar{X}$	25.32				$\bar{X}$	368.00				$\bar{X}$	49.29			
SD	.80				SD	85.49				SD	13.10			

Number of Targets Hit				Total Hits			
D	Mix	$\bar{X}$ Targets Hit	SD	Standard Score z'	E	Mix	$\bar{X}$ Hits
UB	5.1	1.8	79.3		SB	5.2	
SB	4.7	2.0	69.5		UB	5.1	
SA	4.4	0.8	62.4		SA	4.5	
CB	4.2	2.5	57.6		CB	4.5	
UA	4.0	1.1	53.8		SC	4.4	
SC	4.0	2.1	53.6		UA	4.1	
RA	3.1	1.7	31.9		RA	3.1	
CA	3.0	2.0	29.8		UC	3.1	
UD	2.9	1.4	27.4		CA	3.0	
UC	2.9	2.0	26.7		UD	2.9	
$\bar{X}$	3.86				$\bar{X}$	3.98	
SD	.04				SD	.887	

Target Effects		Overall Effectiveness			
F	Mix	Standard Score Target Effects	G	Mix	Overall Fire Effectiveness
SB	70.05		CB	65.77	
SA	68.95		SB	65.50	
SC	63.20		SA	63.53	
UB	59.75		CA	59.73	
CB	57.95		SC	56.17	
CA	47.10		UB	54.43	
UA	42.15		UA	43.87	
RA	35.65		RA	35.30	
UD	28.15		UD	32.43	
UC	25.95		UC	24.30	

Cumulative Exposure Time										
H	UB	SB	SA	CB	SC	UA	UD	CA	RA	UC
UB		.39	.26	.22	.19	.12	.13	.08	.05	.04
SB			.32	.29	.22	.12	.14	.07	.04	.04
SA				.38	.29	.16	.20	.09	.02	.05
CB					>.40	.35	.34	.24	.16	.11
SC						>.40	>.40	.34	.25	.17
UA							>.40	.33	.17	.14
UD								>.40	.28	.18
CA									.35	.21
RA										.29

Number of Near Misses								
I	SC	SA	SB	CB	CA	RA	UB	UC
SC		.30	.18	.09	.06	.005	.005	.04
SA			.27	.11	.06	.002	.003	.04
SB				.29	.19	.02	.02	.04
CB					.38	.04	.04	.04
CA						.06	.06	.04
RA							>.40	.04
UB								>.40
UC								

Sustainability (% Ammo Remaining)										
J	CA	CB	SB	SA	UA	UB	UD	SC	RA	UC
CA		.19	.000	.000	.000	.000	.000	.000	.001	.000
CB			.000	.000	.000	.000	.000	.000	.001	.000
SB				.35	.09	.10	.04	.02	.001	.000
SA					.21	.17	.09	.04	.009	.002
UA						.35	.22	.10	.02	.004
UB							.39	.28	.15	.02
UD								.36	.20	.02
SC									.31	.04
RA										.04

No. of Targets Hit										
K	UB	SB	SA	CB	UA	SC	RA	CA	UD	UC
UB		.36	.20	.25	.13	.19	.05	.04	.02	.04
SB			.37	.36	.25	.30	.10	.09	.05	.08
SA				>.40	.27	.34	.06	.07	.02	.06
CB					>.40	>.40	.22	.20	.15	.18
UA						>.40	.15	.15	.08	.13
SC							.23	.22	.16	.19
RA								>.40	>.40	>.40
CA									>.40	>.40
UD										>.40

Total Hits on Targets							
L	SB	UB	SA	CB	SC	UA	RA
SB		>.40	.20	.34	.25	.09	.03
UB			.26	.36	.28	.13	.04
SA				>.40	>.40	.19	.04
CB					>.40	.36	.19
SC						.37	.16
UA							.14
RA							
UC							
CA							

Note: Standard Scores computed from raw scores using scores to three decimal places.

UA - 9 M14 Rifles  
 UB - 7 M14 Rifles/2 M14E2 AR  
 UC - 5 M14 Rifles/2 M60 MG  
 UD - 9 M14E2 Rifles  
 CA - 9 Colt Rifles

CB - 7 Colt Rifles/2 Colt AR  
 SA - 9 Stoner Rifles  
 SB - 7 Stoner Rifles/2 Stoner AR  
 SC - 7 Stoner Rifles/2 Stoner MG  
 RA - 9 AK47 Rifles

$\bar{X}$  - Mean (Average)  
 SD - Standard Deviation  
 CET - Cumulative Exposure  
 z' - Standard Score ( $X =$

COLLATERAL PERFORMANCE MEASURES

Number of Targets Hit				Total Hits on Targets					
D	MIX	X Targets Hit	SD	Standard Score z'	E	MIX	X Hits	SD	Standard Score z'
	UB	5.1	1.8	79.3		SB	5.2	2.1	76.5
	SB	4.7	2.0	69.5		UB	5.1	1.8	75.1
	SA	4.4	0.8	62.4		SA	4.5	0.8	62.7
	CB	4.2	2.5	57.6		CB	4.5	3.2	62.3
	UA	4.0	1.1	53.8		SC	4.4	2.1	58.9
	SC	4.0	2.1	53.6		UA	4.1	1.1	51.0
	RA	3.1	1.7	31.9		RA	3.1	1.5	30.2
	CA	3.0	2.0	29.8		UC	3.1	2.0	29.1
	UD	2.9	1.4	27.4		CA	3.0	2.0	28.2
	UC	2.9	2.0	26.7		UD	2.9	1.4	26.0
	$\bar{X}$	3.86				$\bar{X}$	3.98		
	SD	.84				SD	.887		

Number of Near Misses

I	UC	SC	SA	SB	CB	CA	RA	UB	UA	UC	UD
.04	SC		.30	.18	.09	.06	.035	.005	.004	.004	.001
.04	SA			.27	.11	.06	.002	.003	.002	.001	.001
.05	SB				.29	.19	.02	.02	.01	.009	.001
.11	CB					.38	.04	.04	.03	.02	.001
.17	CA						.06	.06	.04	.04	.001
.14	RA							.40	.35	.32	.001
.18	UB								.40	.40	.004
.21	UA									.40	.002
.29	UC										.001

Total Hits on Targets

L	UC	SB	UB	SA	CB	SC	UA	RA	UC	CA	UD
.04	SB		>.40	.20	.34	.25	.09	.03	.04	.03	.02
.08	UB			.26	.36	.28	.13	.04	.05	.04	.02
.06	SA				>.40	>.40	.19	.04	.06	.05	.02
.18	CB					>.40	.36	.19	.18	.18	.14
.13	SC						.37	.16	.16	.15	.10
.19	UA							.14	.16	.15	.08
.40	RA								>.40	>.40	>.40
.40	UC									>.40	>.40
.40	CA										>.40

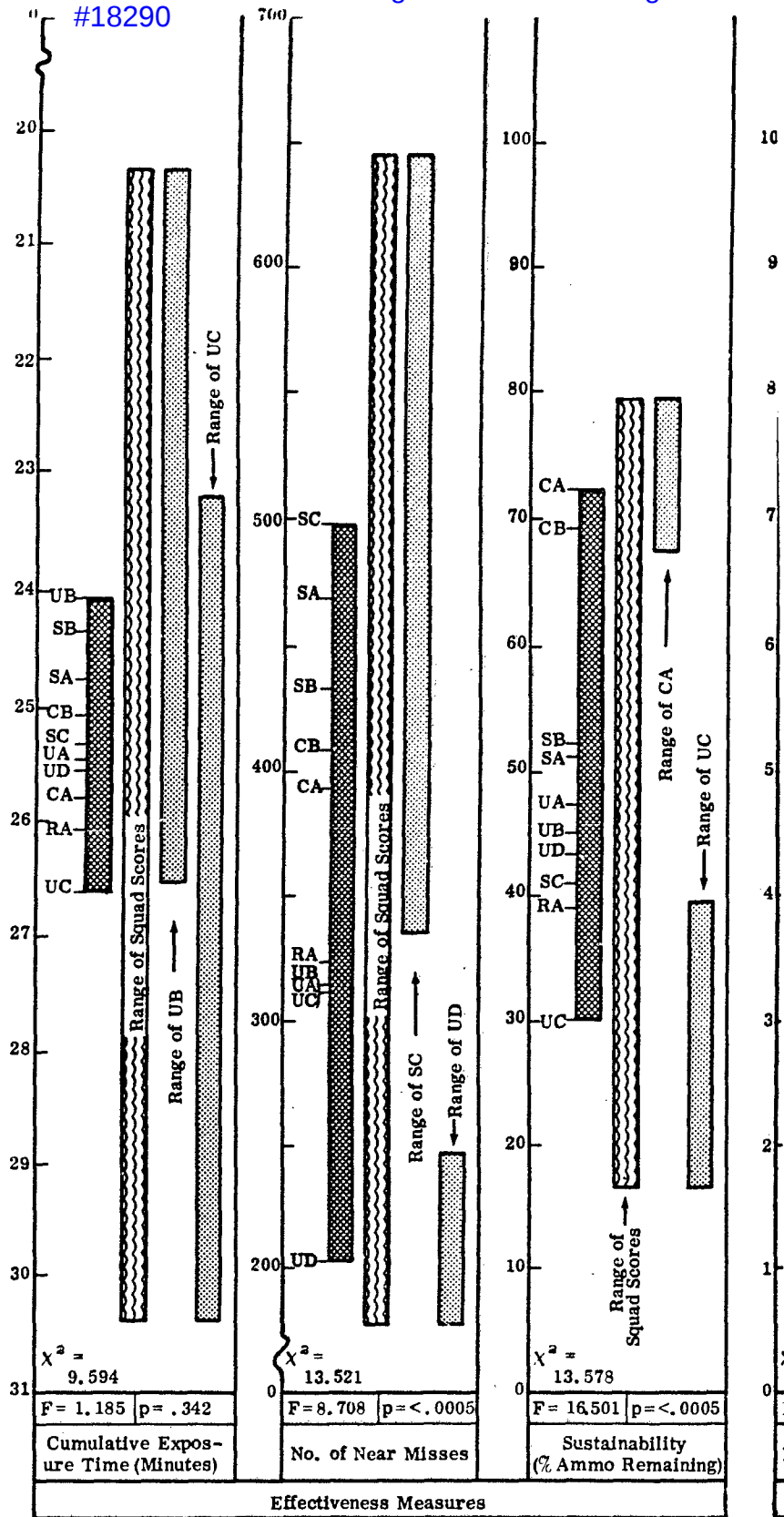

1/2 Colt AR  
1/2 Stoner AR  
1/2 Stoner MG

$\bar{X}$  - Mean (Average)  
SD - Standard Deviation  
CET - Cumulative Exposure Time  
z' - Standard Score ( $\bar{X} = 50$ ,  $SD = 20$ )

Figure 6-1 SUMMARY OF RESULTS--

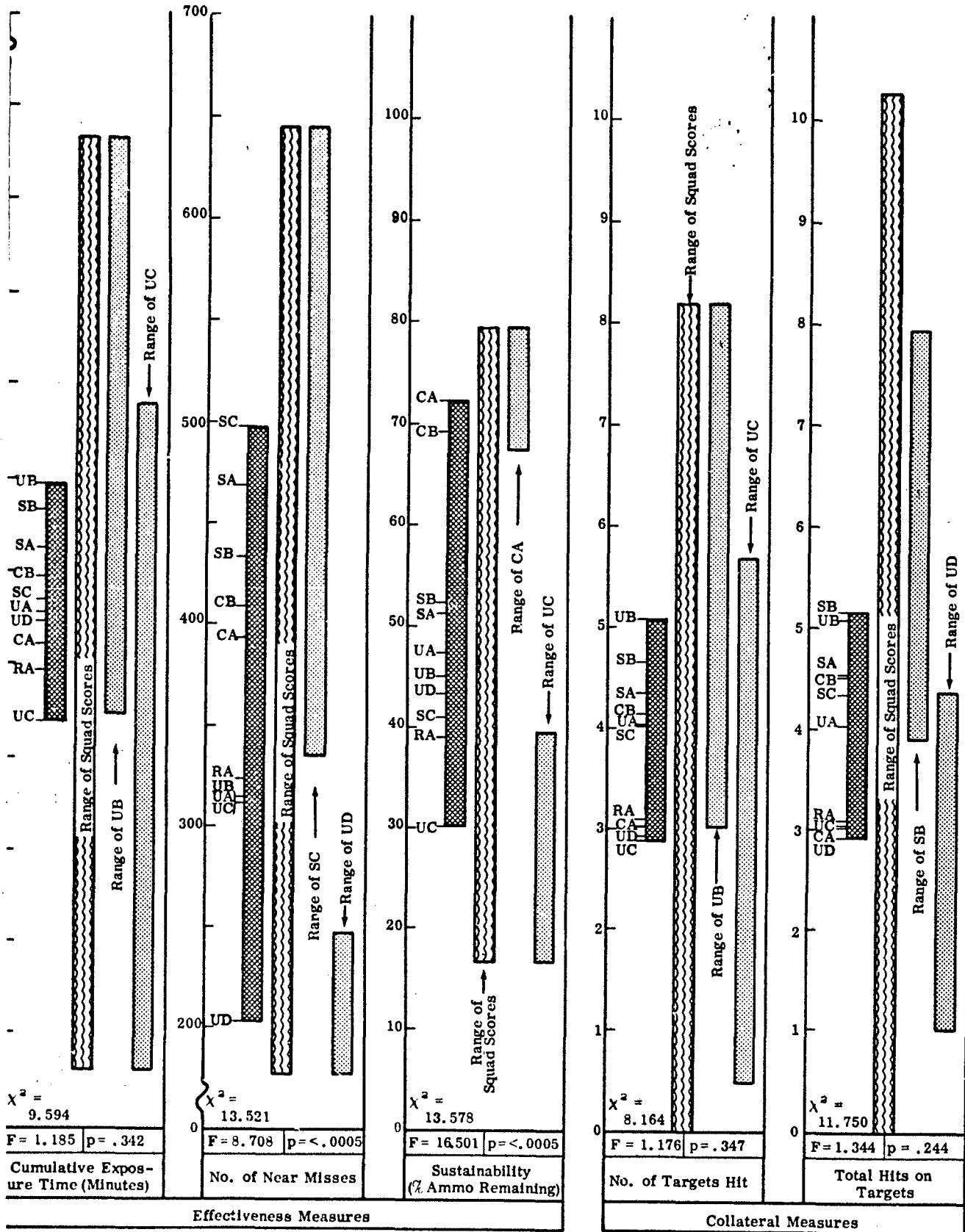

Figure 6-1 SUMMARY OF RESULTS--SITUATION 1

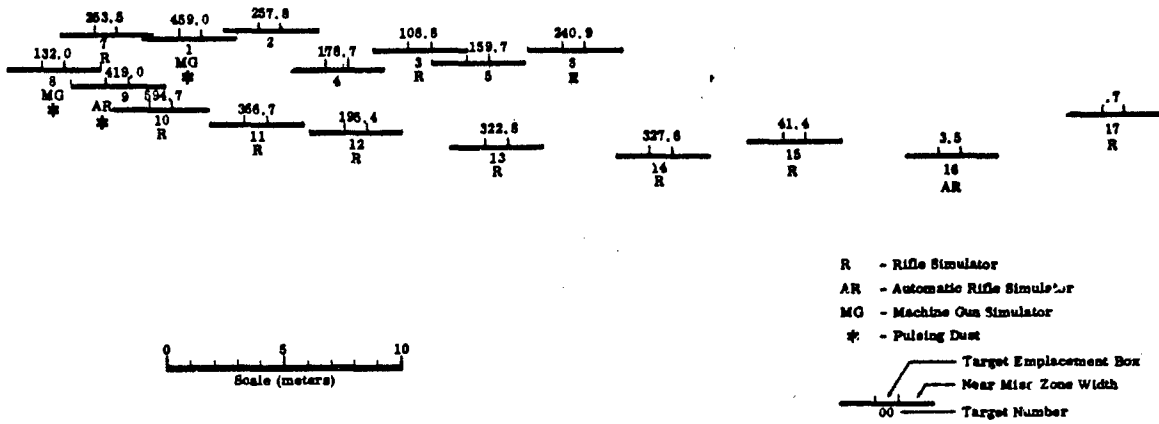

Figure 6-2  
VERTICAL PROFILE--SITUATION 1

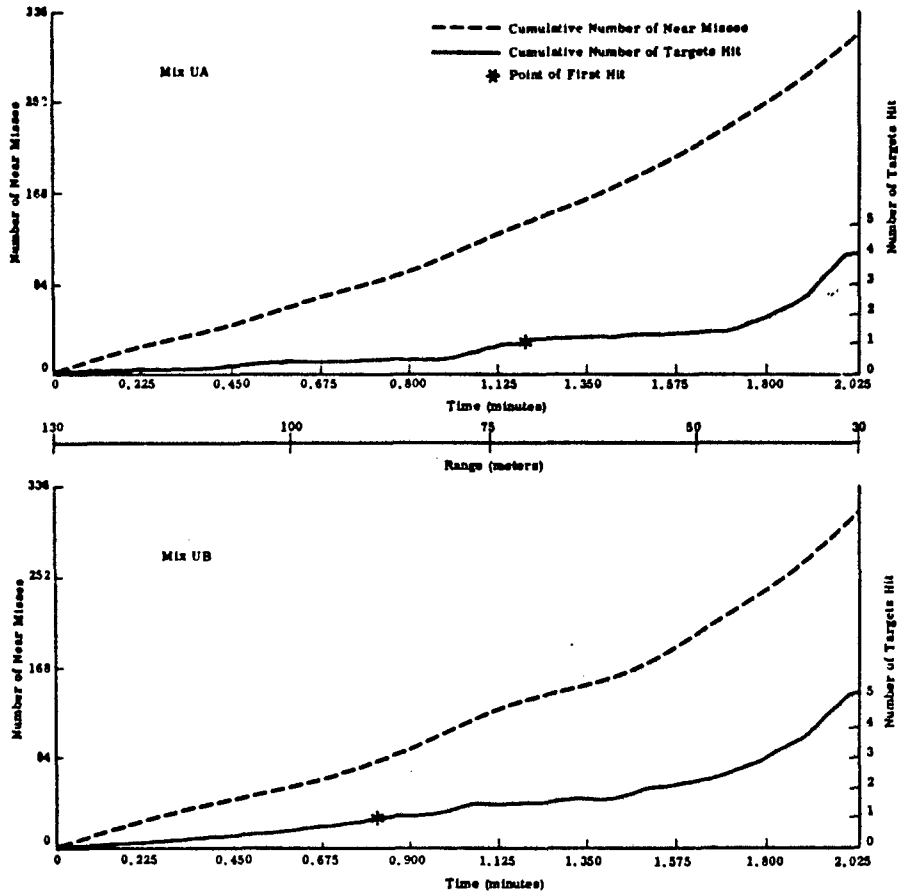

Figure 6-3 CUMULATIVE NUMBER OF NEAR MISSES AND TARGETS HIT--SITUATION 1

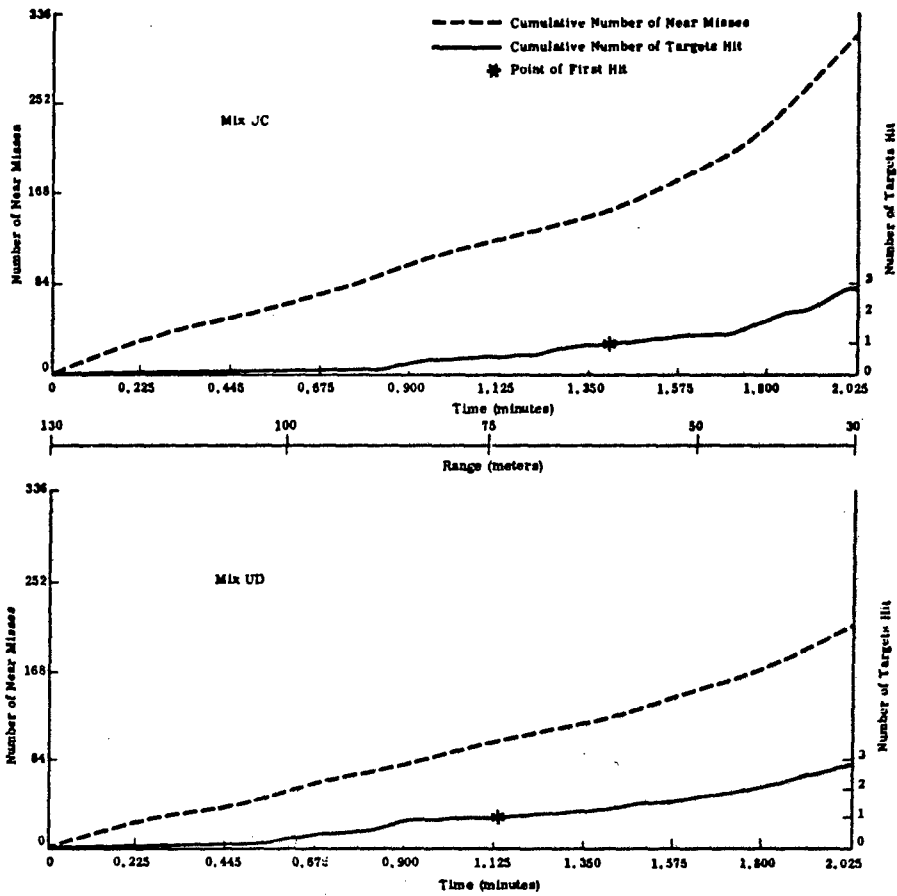

Figure 6-3 (Continued) CUMULATIVE NUMBER OF NEAR MISSES AND TARGETS HIT--SITUATION 1



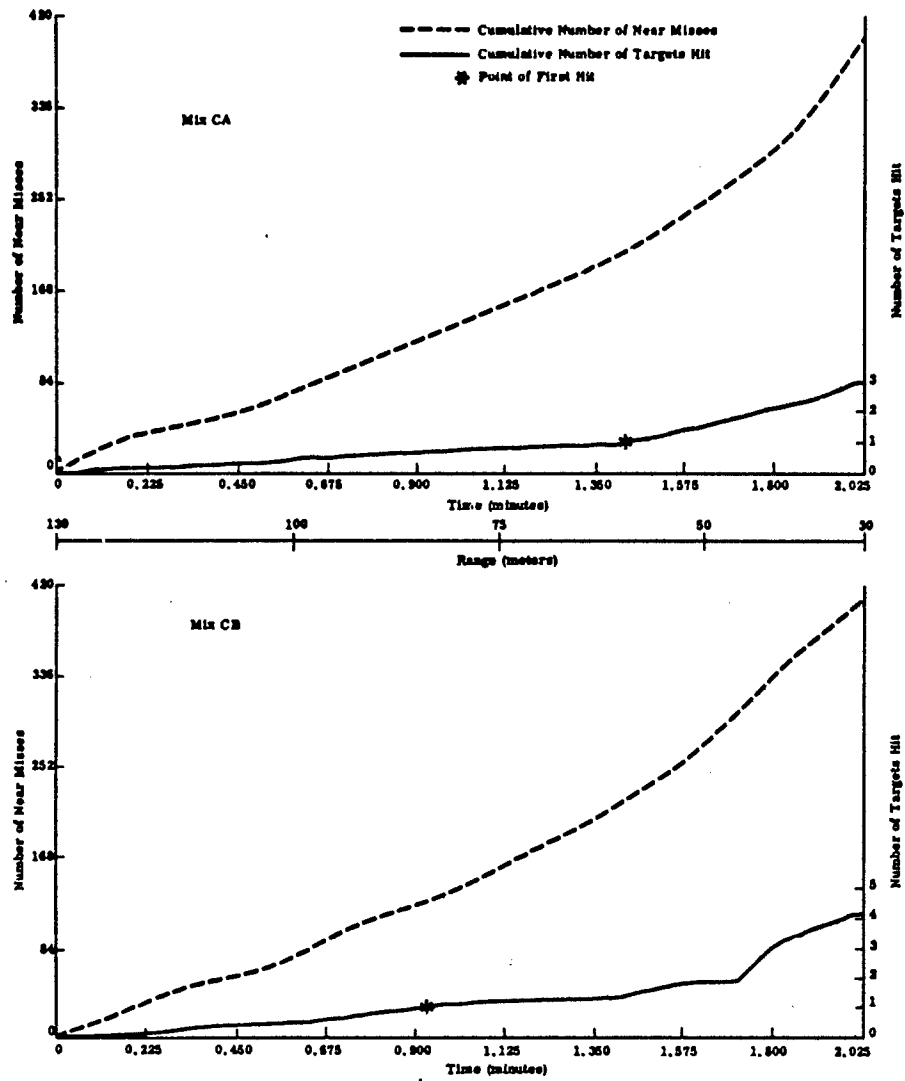

Figure 6-3 (Continued) CUMULATIVE NUMBER OF NEAR MISSES AND TARGETS HIT--SITUATION 1

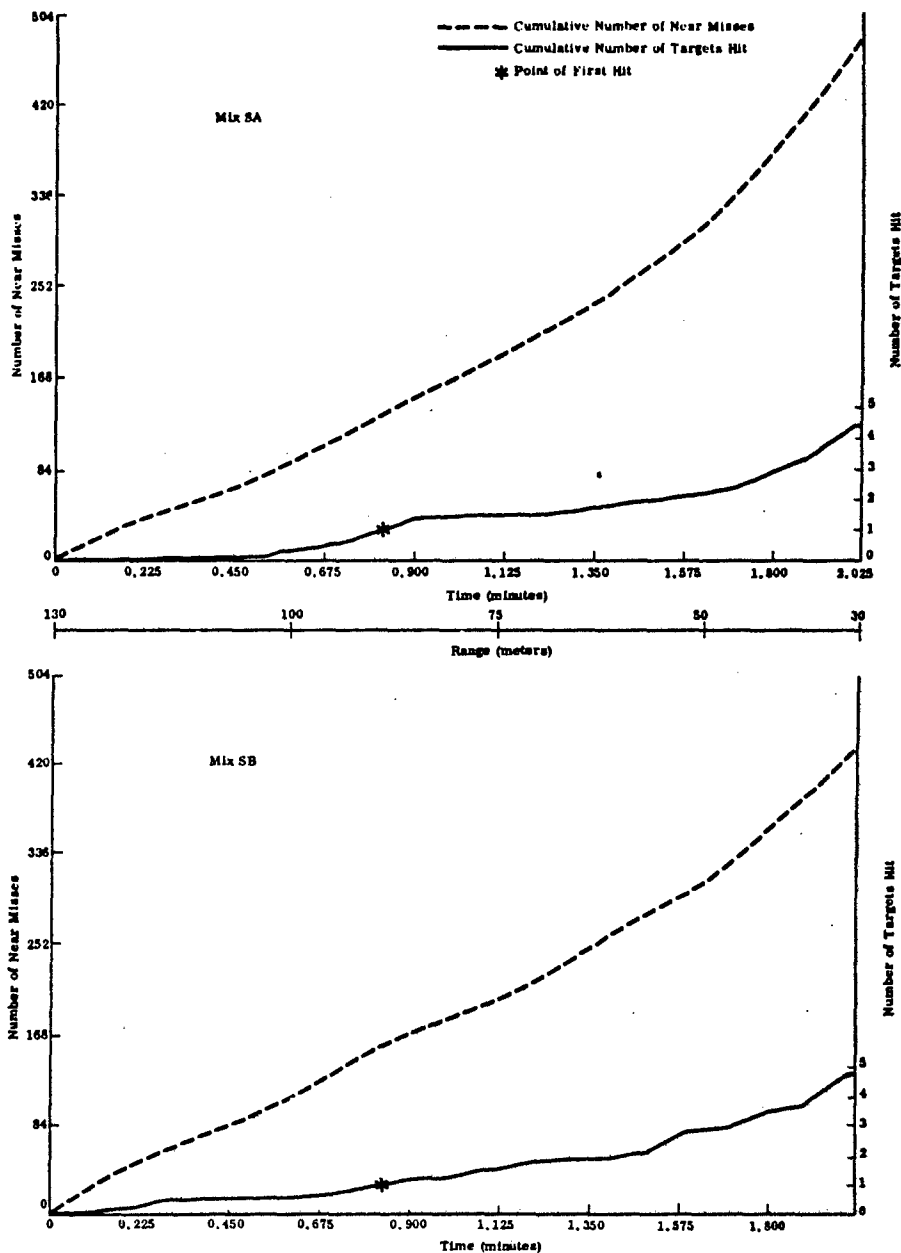

Figure 6-3 (Continued) CUMULATIVE NUMBER OF NEAR MISSES AND TARGETS HIT--SITUATION 1

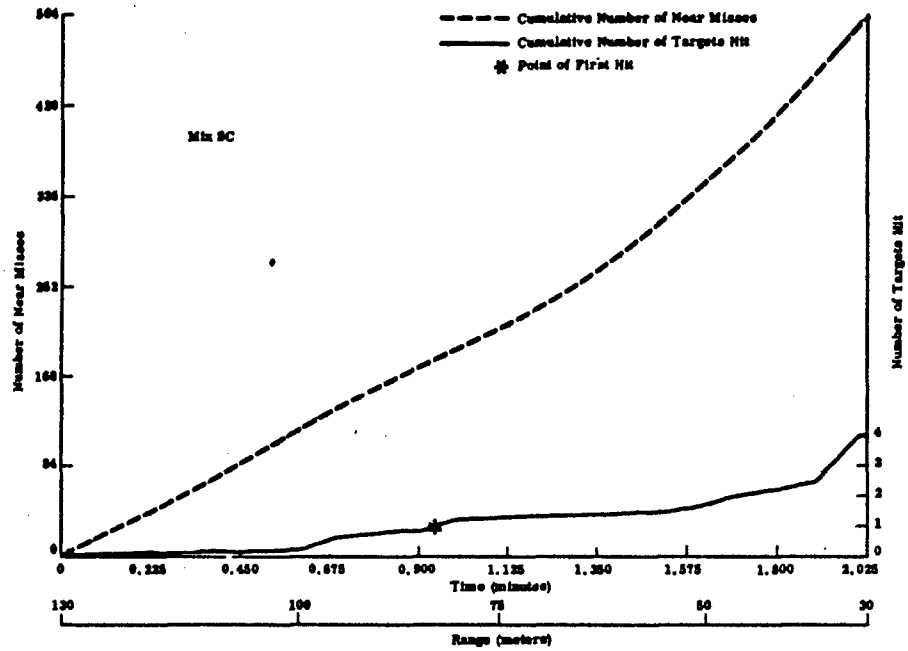

Figure 6-3 (Continued) CUMULATIVE NUMBER OF NEAR MISSES AND TARGETS HIT--SITUATION 1

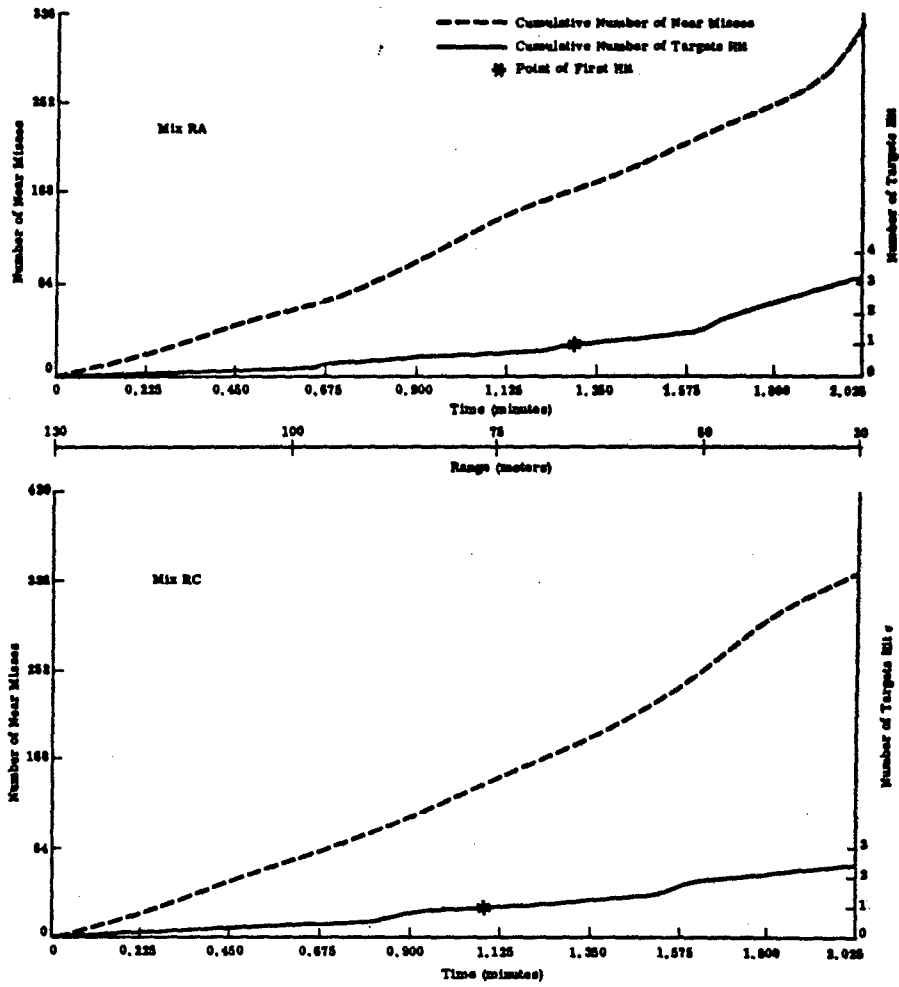

Figure 6-3 (Concluded) CUMULATIVE NUMBER OF NEAR MISSES AND TARGETS HIT--SITUATION 1

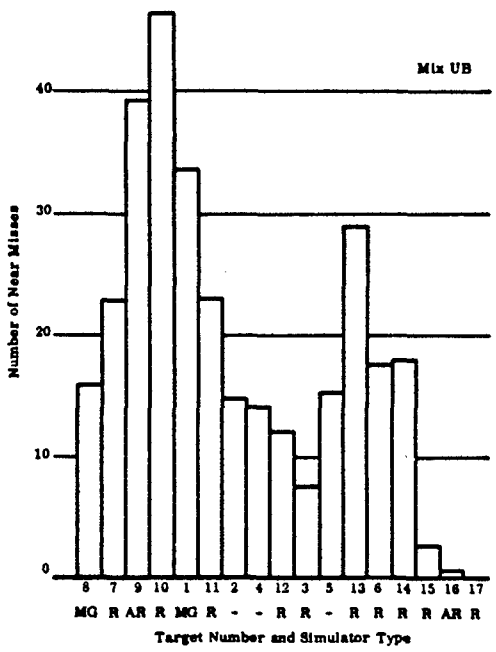
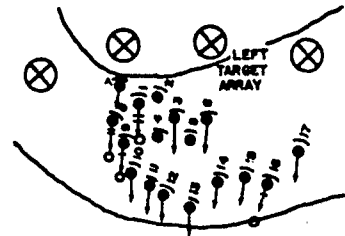
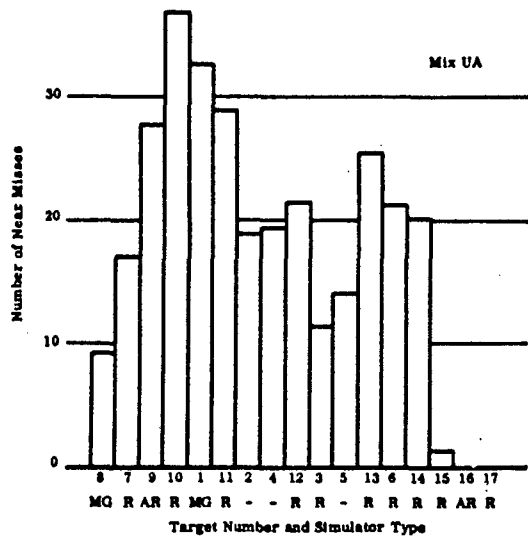

Figure 6-4 NUMBER AND DISTRIBUTION OF NEAR MISSES--SITUATION 1

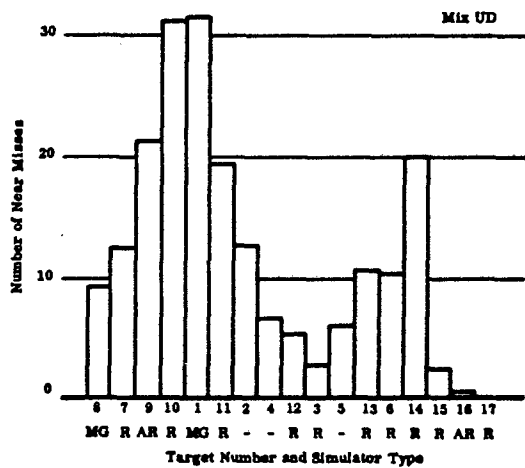
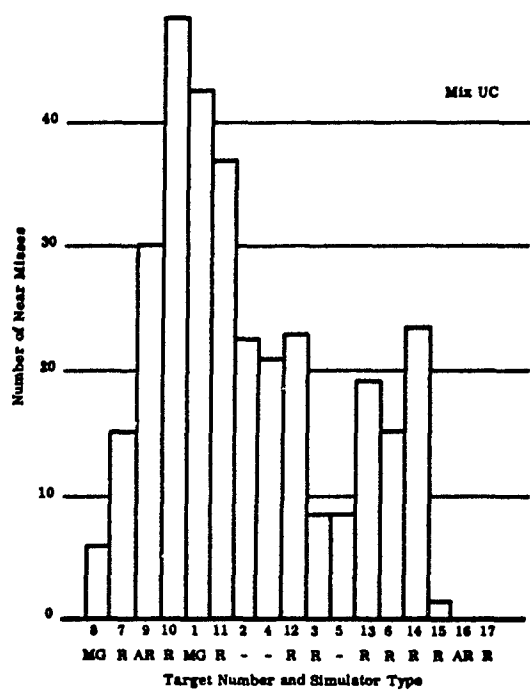

Figure 6-4 (Continued) NUMBER AND DISTRIBUTION OF NEAR MISSES--SITUATION 1

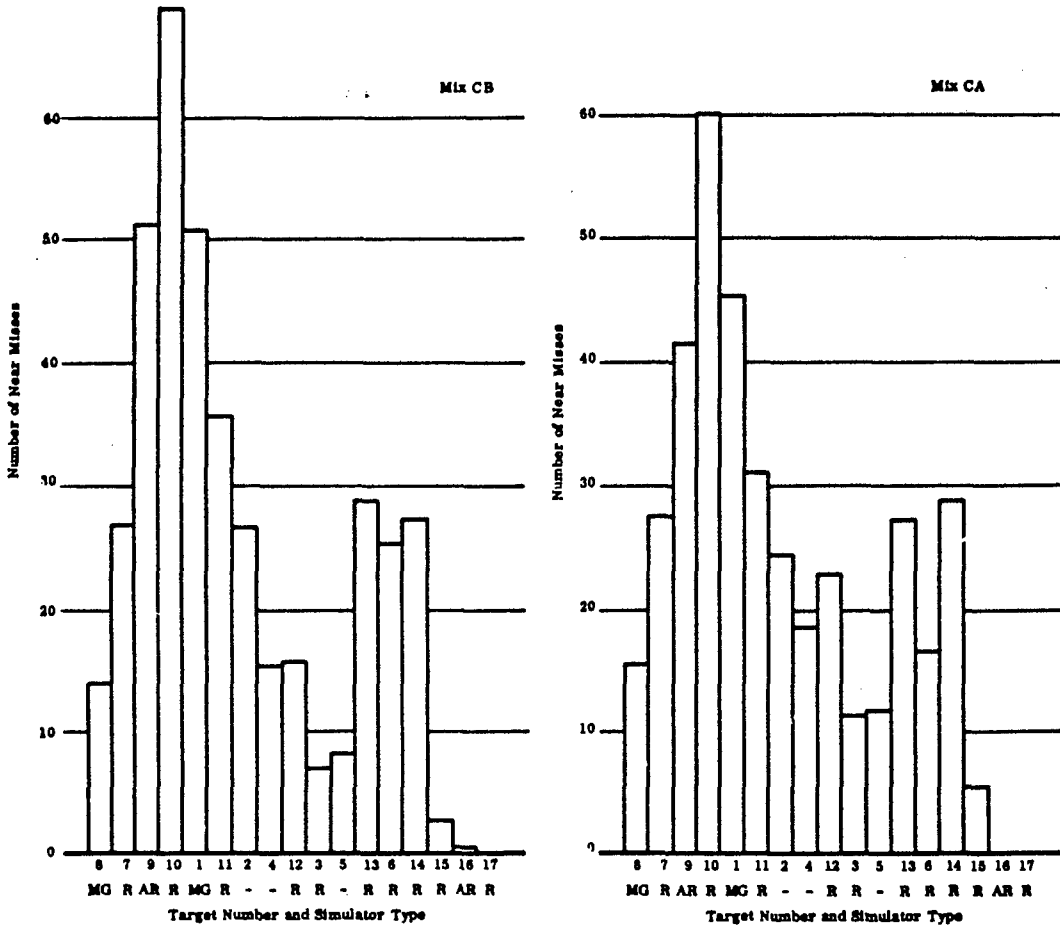
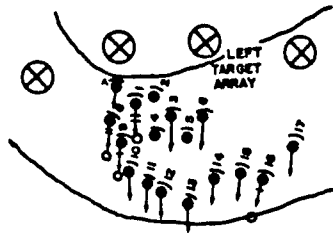

Figure 6-4 (Continued) NUMBER AND DISTRIBUTION OF NEAR MISSES--SITUATION 1

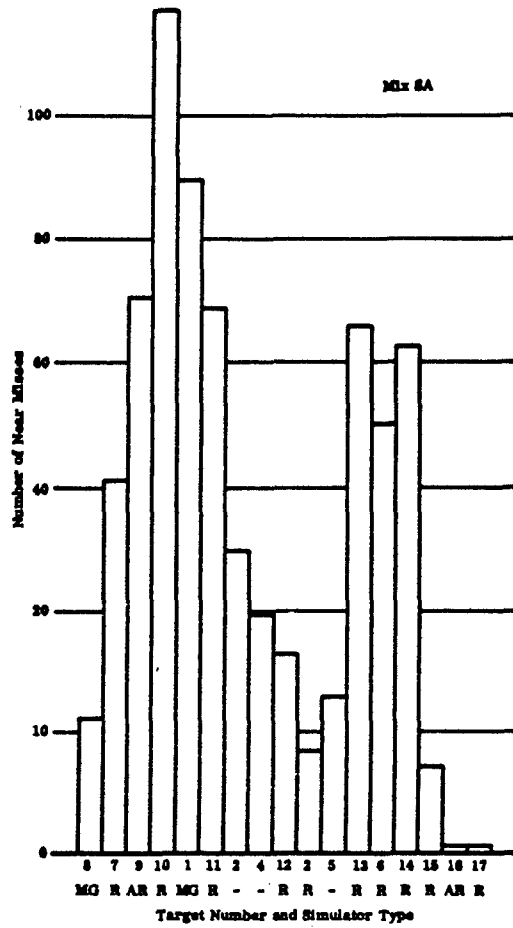

Figure 6-4 (Continued) NUMBER AND DISTRIBUTION OF NEAR MISSES--SITUATION 1



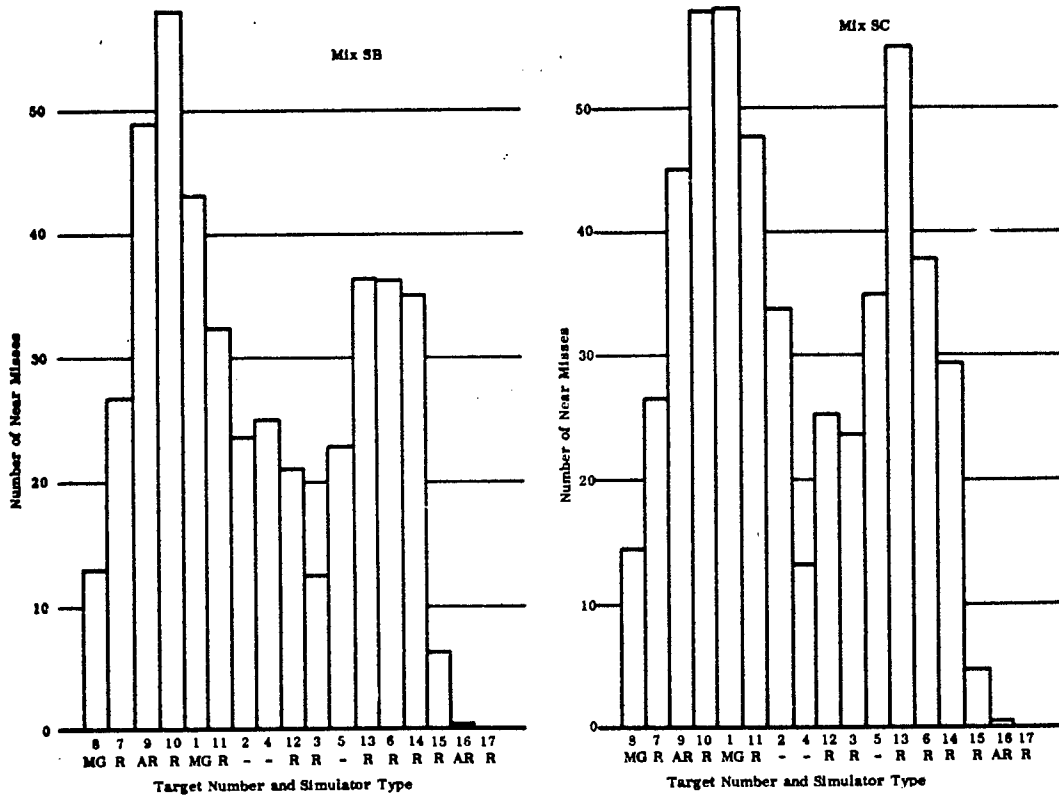
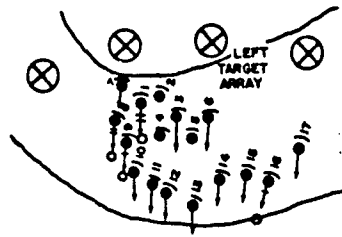

Figure 6-4 (Continued) NUMBER AND DISTRIBUTION OF NEAR MISSES--SITUATION 1.

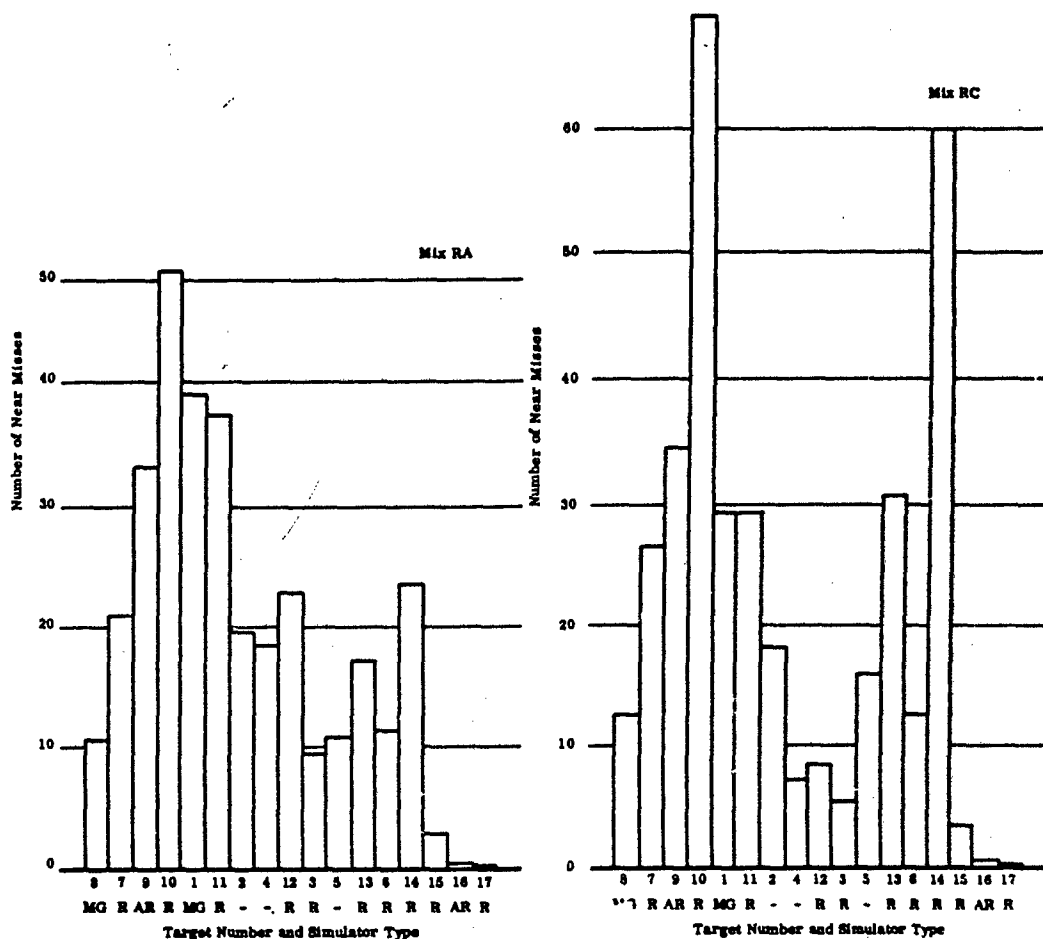

Figure 6-4 (Concluded) NUMBER AND DISTRIBUTION OF NEAR MISSES--SITUATION 1

**2. Situation 2: Rifle Squad as Base of Fire Supporting the Assault**

This situation evaluated rifle squad weapon mixes firing supporting fire from hastily prepared foxholes. Range from the foxholes to enemy targets was from 269 to 326 meters. There were 30 concealed or partially concealed enemy targets occupying a position 100 meters wide and 35 meters deep. The duration of fire was 4 minutes. For the first 2 minutes, fire was directed at the left 50 meters of the enemy array (the 17 targets used in Situation 1 Assault). Fire was then shifted 50 meters to the right, to an area containing 13 targets. The technique of fire provided area fire distributed throughout the sector with point fire employed when a target was seen, or when weapon simulators gave detected cues to a particular target location.

Results for Situation are tabulated and presented graphically in Figure 6-5.

Vertical profiles of the target arrays appear in Figure 6-6, showing positions and relative differences in elevation as seen from the support positions. The average number of near misses for all rifle mixes (not including special weapons mixes or duplex) is given by the number over each target. Also indicated are the simulator cues associated with each target and the total width of the 2-meter radius semicircular zone in which near misses were sensed.

Figure 6-7 illustrates the cumulative number of near misses for each array, the percent of ammunition remaining, targets hit, and ammunition used as a function of time. For Mix RC, only cumulative number of hits is presented. Figure 6-8 shows the number of near misses and their distributions as a function of target location and array. Target locations are provided for purpose of comparison in insert maps.

The rank order of the ten weapons mixes with associated standard scores is presented below.

Target Effects Only			Overall Effectiveness*		
Rank	Mix	Standard Score	Rank	Mix	Standard Score
1	CA	68.2	1	CA	73.6
2	SC	60.1	2	CB	62.6
3	UB	59.9	3	UA	55.4
4	UA	58.9	4	SC	54.8
5	CB	57.0	5	UB	51.2
6	UD	56.9	6	UD	48.2
7	SB	47.1	7	SA	46.5
8	UC	43.5	8	SB	45.5
9	SA	36.5	9	UC	36.4
10	RA	11.6	10	RA	29.8

\* Sustainability weighted 1/3; Target effects 2/3

Key:

- |                                    |   |
|------------------------------------|---|
| UA - 9 M14 Rifles                  | SB - 7 Stoner Rifles and<br>2 Stoner AR |
| UD - 9 M14E2 Rifles                | SC - 7 Stoner Rifles and<br>2 Stoner MG |
| UB - 7M14 Rifles and<br>2 M14E2 AR | CA - 9 Colt Rifles                      |
| UC - 5M14 Rifles and<br>2 M60 MG   | CB - 7 Colt Rifles and<br>2 Colt AR     |
| SA - 9 Stoner Rifles               | RA - 9 AK47 Rifles                      |

Mix RC results for Situation 2 are presented below.

Mix	CET	Percent Ammo Remaining	Near Misses	Targets Hit	Total Hits
RC	80.70	0	354.80	10.00	10.4

EFFECTIVENESS MEASURES

COLLATERAL PERFORMANCE

A Cumulative Exposure Times					B Number of Near Misses					C Sustainability (T. Ammo Remaining)					D Number of Targets Hit					E Tot	
Mix	$\bar{X}$	CET	SD	Standard Score z'	Mix	$\bar{X}$	Near Misses	SD	Standard Score z'	Mix	$\bar{X}$	Remaining	SD	Standard Score z'	Sustainability Time (Min)	Mix	$\bar{X}$	Targets Hit	SD	Standard Score z'	Mix
UA	77.5	2.3	77.1		CB	345	47.9	73.6		CA	50.5	9.2	94.4	8.1		UA	10.7	1.7	82.2		UA
CA	78.2	10.0	71.2		SC	326	76.3	66.4		CB	42.2	1.6	73.9	6.9		CA	10.1	3.5	69.8		UB
UD	78.6	8.3	68.3		CA	323	90.7	65.2		RA	36.0	6.1	66.1	6.3		UB	10.0	1.6	67.8		CA
UB	80.0	6.6	59.0		UC	318	34.4	63.4		SA	28.5	4.3	56.7	5.6		SB	9.4	2.9	55.4		SB
BC	80.4	9.4	53.8		UB	312	46.7	60.8		UA	22.0	6.7	48.5	5.1		SC	9.1	3.2	49.2		SA
BB	81.0	10.1	48.9		UD	272	52.3	45.6		SB	17.2	6.8	42.5	4.8		BA	8.9	2.4	44.5		UD
BA	82.0	9.1	41.4		SB	271	72.1	45.2		SC	16.2	8.5	41.2	4.8		UD	8.8	3.2	43.0		SC
CB	82.1	4.6	40.4		UA	259	36.1	40.6		UD	10.3	5.6	33.8	4.5		CB	8.6	2.4	38.8		UC
UC	84.2	7.2	23.6		SA	236	61.3	31.8		UB	7.8	6.7	30.6	4.3		UC	8.5	2.9	36.8		CB
RA	85.1	10.9	16.6		RA	173	22.0	6.6		UC	1.2	1.5	22.3	4.1		RA	7.3	3.9	12.0		RA
$\bar{X}$	80.9				$\bar{X}$	283.7				$\bar{X}$	23.8					$\bar{X}$	9.14				$\bar{X}$
SD	2.52				SD	52.18				SD	15.9					SD	.97				SD

F Target Effects		G Overall Effectiveness		H Cumulative Exposure Times										I Number of Near Misses					
Mix	Standard Score Target Effects	Mix	Overall Fire Effectiveness	UA	CA	UD	UB	SC	SB	SA	CB	UC	RA	CB	SC	CA	UC	UB	UD
CA	68.2	CA	73.6	UA	>.40	.38	.22	.24	.21	.14	.03	.03	.07	CB	.35	.33	.25	.22	.06
SC	60.1	CB	62.6	CA		>.40	.38	.35	.32	.26	.20	.13	.15	SC		>.40	>.40	.35	.09
UB	59.9	UA	55.4	UD			>.40	.37	.33	.26	.19	.12	.15	CA			>.40	.39	.11
UA	58.9	SC	54.8	UB				>.40	>.40	.32	.24	.15	.17	UC				.39	.06
CB	57.0	UB	51.2	SC					>.40	.39	.35	.23	.23	UB					.10
UD	56.9	UD	48.2	SB						>.40	>.40	.27	.27	UD					>.40
SB	47.1	SA	46.5	SA							>.40	.32	.31	SB					
UC	43.5	SB	45.5	CB								.28	.28	UA					
SA	36.5	UC	36.4	UC									>.40	SA					
RA	11.6	RA	29.8																

J Sustainability (i Ammo Remaining)										K No. of Targets Hit										L Total Hits on Target					
CA	CB	RA	SA	UA	SB	SC	UB	UD	UC	UA	CA	UB	SB	SC	SA	UD	CB	UC	RA	UA	UB	CA	SB	SA	UD
CA		.03	.01	.001	.001	.001	.001	.001	.001	UA	.35	.23	.18	.15	.08	.11	.05	.07	.04	UA	.11	.15	.11	.07	.10
CB			.02	.001	.001	.001	.001	.001	.001	CA		>.40	.36	.31	.25	.26	.20	.21	.12	UB		>.40	.39	.24	.31
RA				.02	.004	.001	.002	.001	.001	UB			.34	.28	.20	.23	.14	.15	.08	CA			>.40	.34	.36
SA					.04	.004	.005	.001	.001	SD				>.40	.37	.37	.30	.30	.16	SB				>.40	>.40
UA						.12	.11	.005	.003	SC					>.40	>.40	.39	.37	.21	SA					>.40
SB							>.40	.04	.02	SA						>.40	>.40	>.40	.21	UD					
SC								.10	.05	UD							>.40	>.40	.24	SC					
UB									.25	CB								>.40	.25	UC					
UD										UC									.28	CB					

Note: Standard Scores computed from raw scores using scores to three decimal places.

UA - 9 M14 Rifles  
 UB - 7 M14 Rifles/2 M14E2 AR  
 UC - 5 M14 Rifles/2 M60 MG  
 UD - 9 M14E2 Rifles  
 CA - 9 Colt Rifles

CB - 7 Colt Rifles/2 Colt AR  
 SA - 9 Stoner Rifles  
 SB - 7 Stoner Rifles/2 Stoner AR  
 SC - 7 Stoner Rifles/2 Stoner MG  
 RA - 9 AK47 Rifles

$\bar{X}$  - Mean (Average)  
 SD - Standard Dev  
 CET - Cumulative Exposure Times  
 z' - Standard Score

COLLATERAL PERFORMANCE MEASURES

D Number of Targets Hit				E Total Hits on Targets			
Mix	$\bar{X}$ Targets Hit	SD	Standard Score $z'$	Mix	$\bar{Y}$ Hits	SD	Standard Score $z'$
UA	10.7	1.7	82.2	UA	12.6	4.0	93.9
CA	10.1	3.5	69.8	UB	10.3	1.4	59.9
UB	10.0	1.6	67.8	CA	10.2	3.3	58.4
SB	9.4	2.9	55.4	SB	9.9	3.0	54.0
SC	9.1	3.2	49.2	SA	9.6	2.0	49.6
SA	8.9	2.4	44.5	UD	9.5	3.6	48.1
UD	8.8	3.2	43.0	SC	9.1	3.2	42.2
CB	8.6	2.4	38.8	UC	9.0	3.5	40.7
UC	8.5	2.9	36.8	CB	8.8	2.3	37.7
RA	7.3	3.9	12.0	RA	7.3	3.9	15.6
$\bar{X}$	9.14			$\bar{X}$	9.63		
SD	.97			SD	1.35		

Number of Near Misses

	CB	SC	CA	UC	UB	UD	SB	UA	SA	RA
17 CB		.35	.33	.25	.22	.06	.07	.02	.02	.002
15 SC			>.40	>.40	.35	.09	.12	.04	.02	.002
15 CA				>.40	.39	.11	.14	.05	.03	.003
17 UC					.39	.06	.09	.01	.01	.001
23 UB						.10	.14	.03	.02	.001
27 UD							>.40	.31	.15	.003
31 SB								.36	.19	.01
28 UA									.23	.001
10 SA										.03

Total Hits on Targets

	UA	UB	CA	SB	SA	UD	SC	UC	CB	RA
14 UA		.11	.15	.11	.07	.10	.07	.07	.04	.03
2 UB			>.40	.39	.24	.31	.21	.20	.10	.05
18 CA				>.40	.34	.36	.28	.27	.20	.10
6 SB					>.40	>.40	.33	.32	.24	.12
21 SA						>.40	.38	.37	.27	.12
11 UD							>.40	>.40	.35	.18
24 SC								>.40	>.40	.21
25 UC									>.40	.23
28 CB										.22

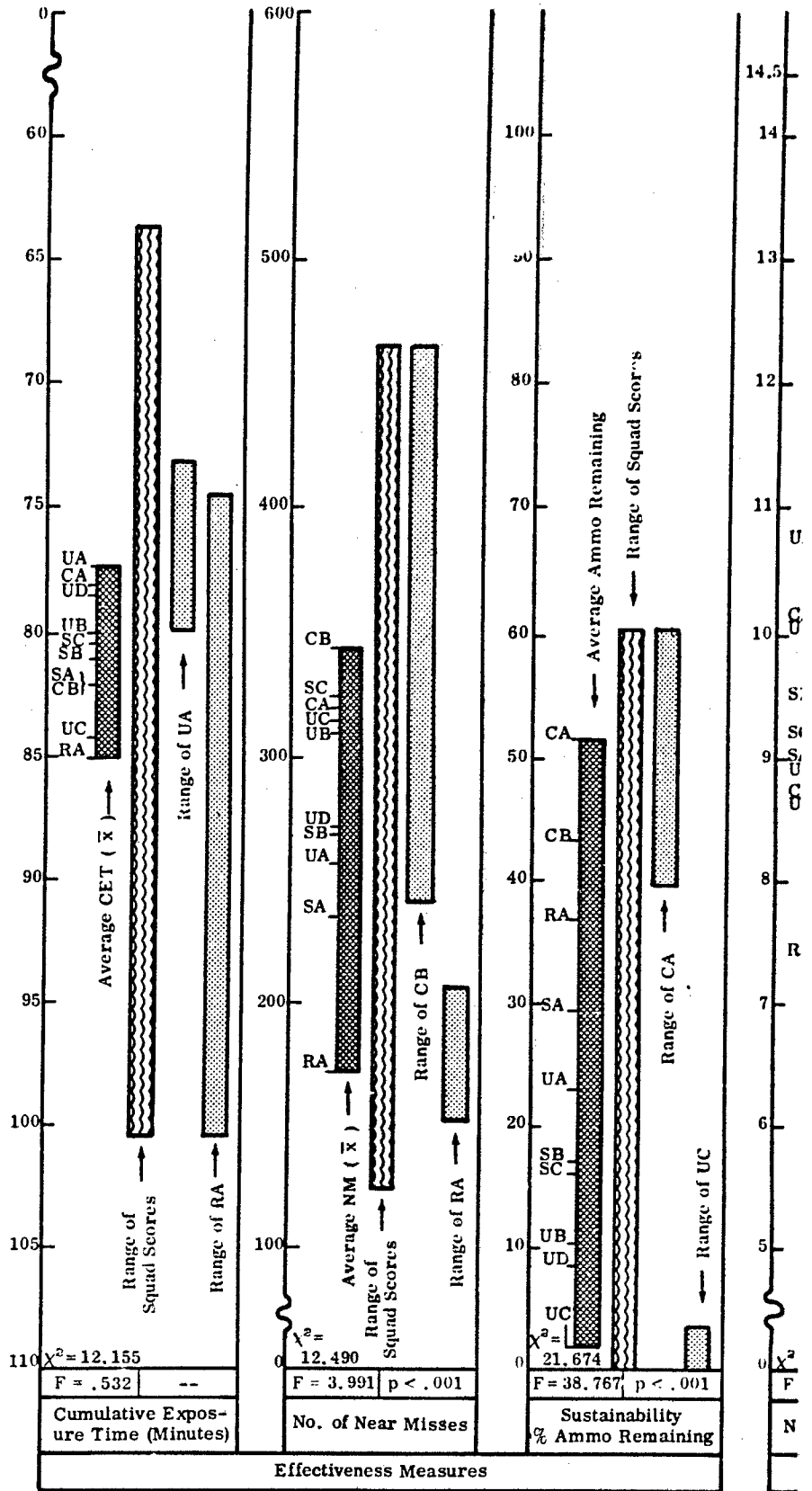

Colt AR  $\bar{X}$  - Mean (Average)  
 2 Stoner AR SD - Standard Deviation  
 2 Stoner MG CET - Cumulative Exposure Time  
 $z'$  - Standard Score ( $X = 50, SD = 20$ )

Figure 6-5 SUMMARY OF RESULTS--S

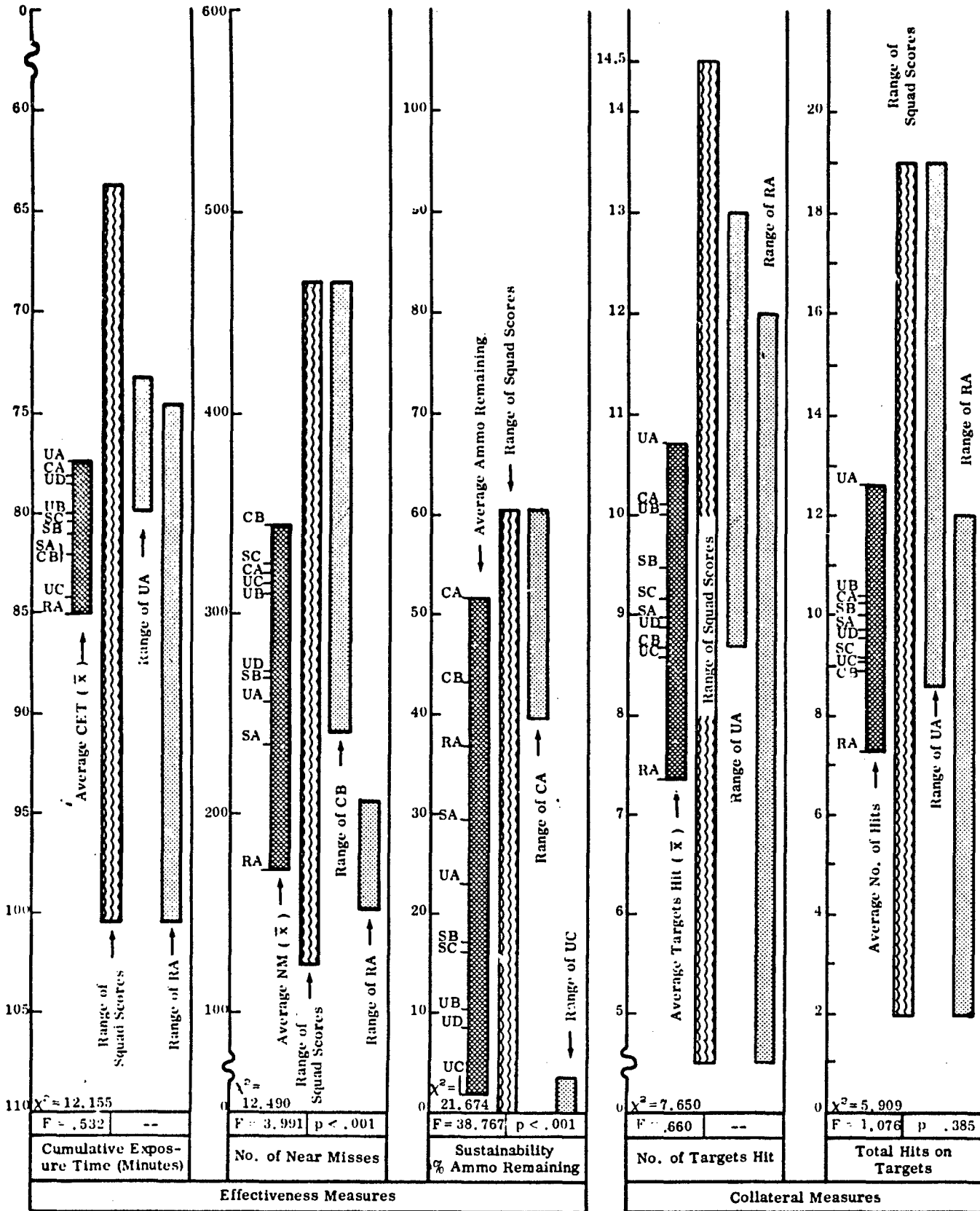
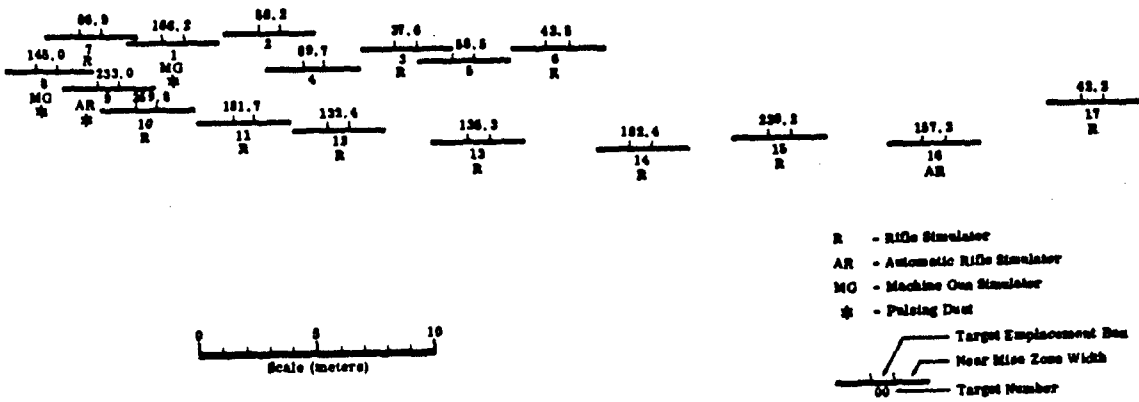
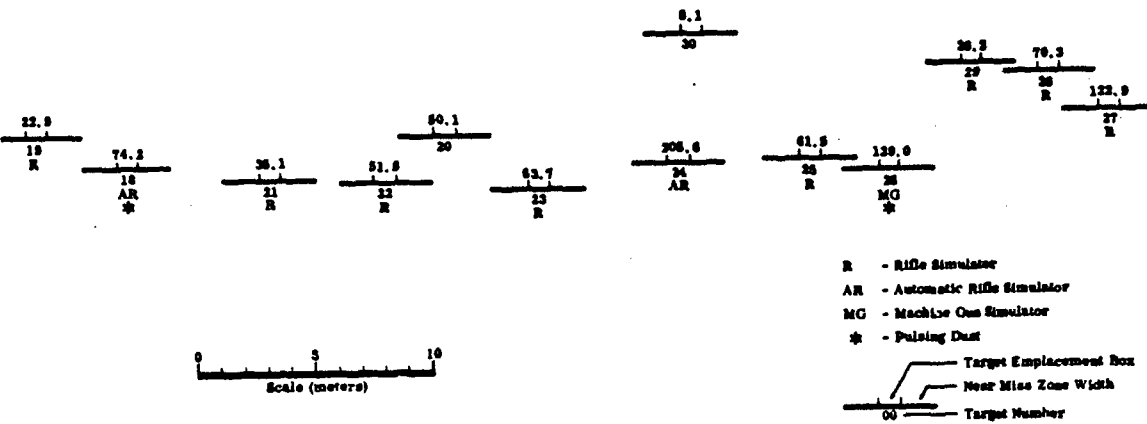

Figure 6-5 SUMMARY OF RESULTS--SITUATION 2



Left Array



Right Array

Figure 6-6 VERTICAL PROFILES--SITUATION 2



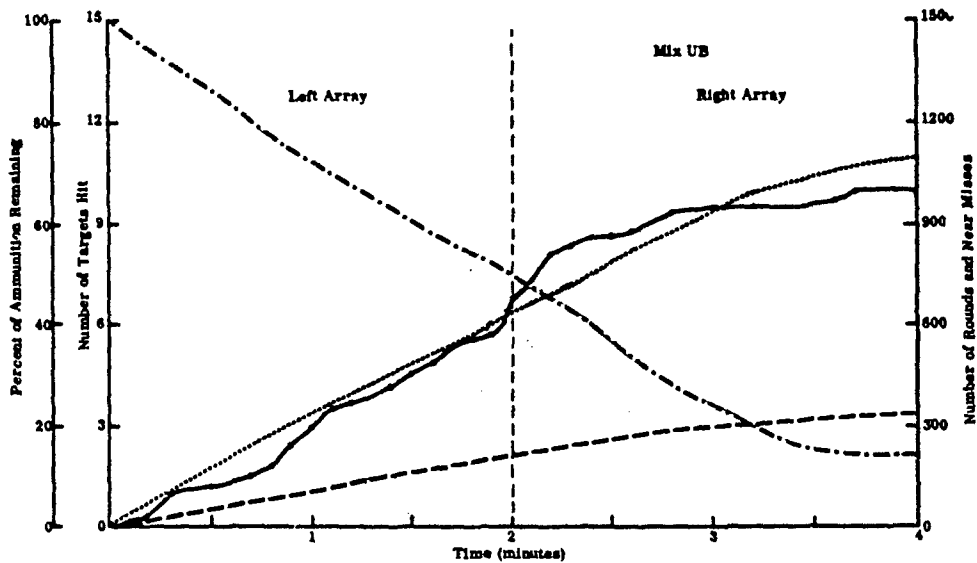
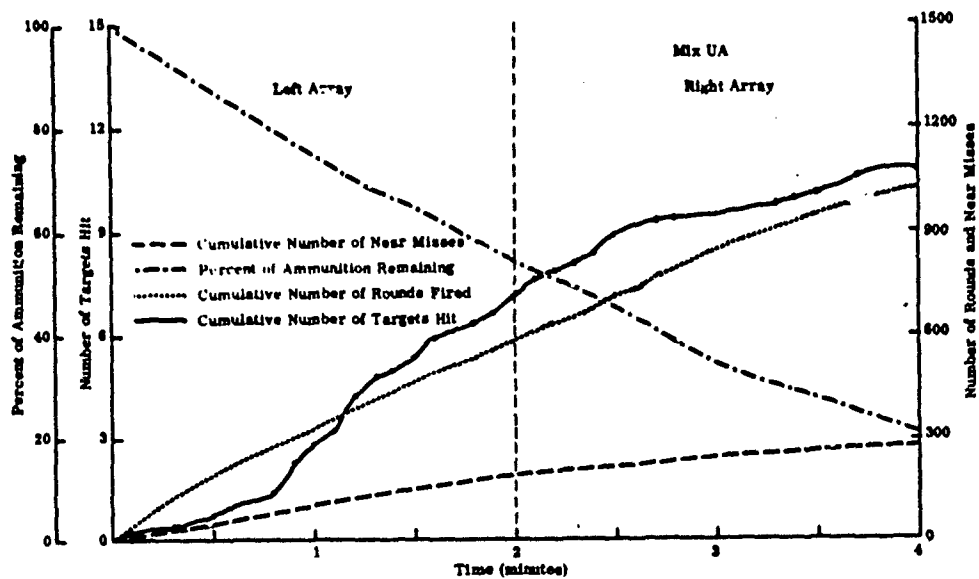

Figure 6-7 CUMULATIVE NUMBER OF ROUNDS FIRED, TARGETS HIT, NEAR MISSES, AND PERCENT OF AMMUNITION REMAINING--SITUATION 2

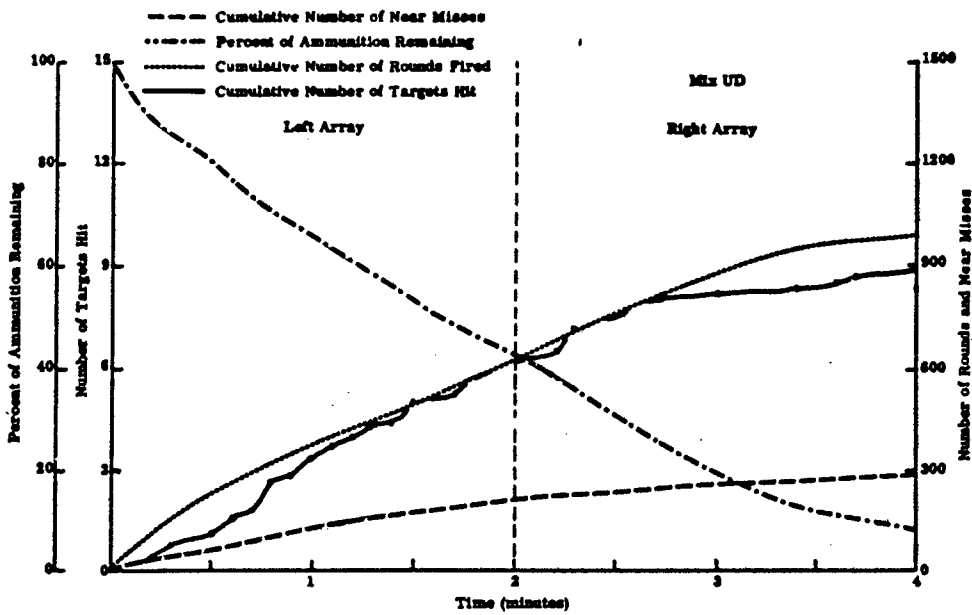
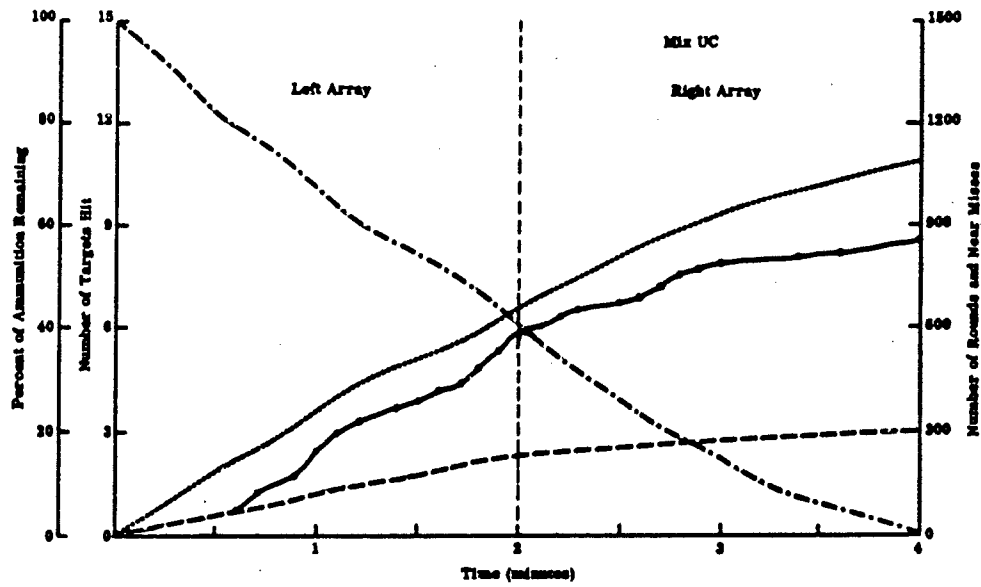

Figure 6-7 (Continued) CUMULATIVE NUMBER OF ROUNDS FIRED, TARGETS HIT, NEAR MISSES, AND PERCENT OF AMMUNITION REMAINING--SITUATION 2

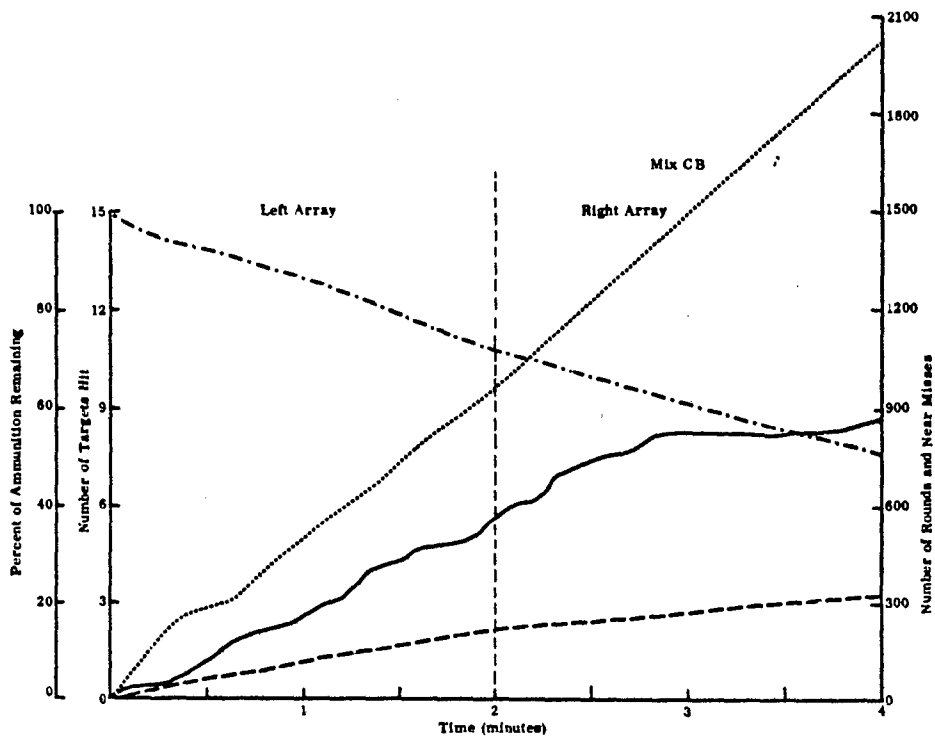
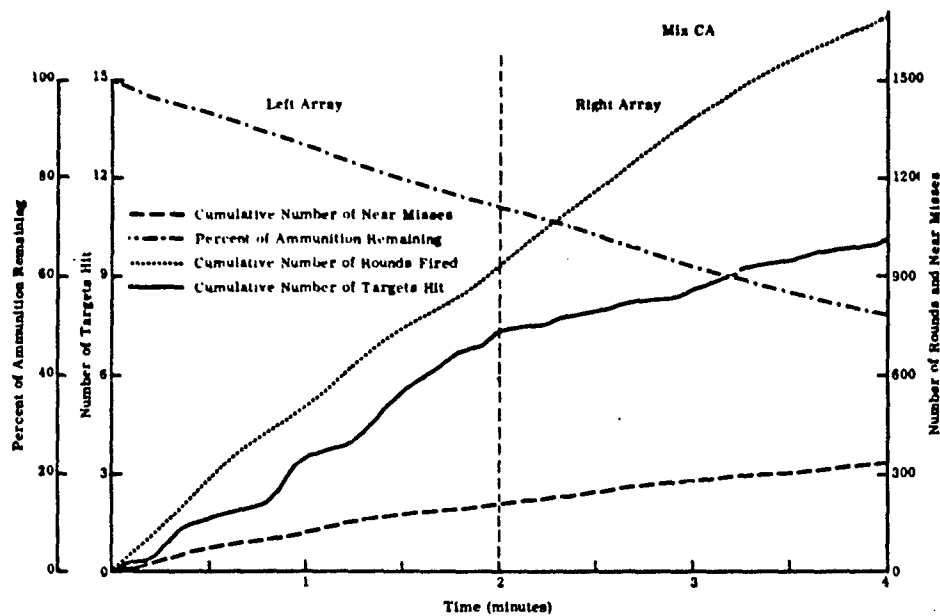

Figure 6-7 (Continued) CUMULATIVE NUMBER OF ROUNDS FIRED, TARGETS HIT, NEAR MISSES AND PERCENT OF AMMUNITION REMAINING--SITUATION 2

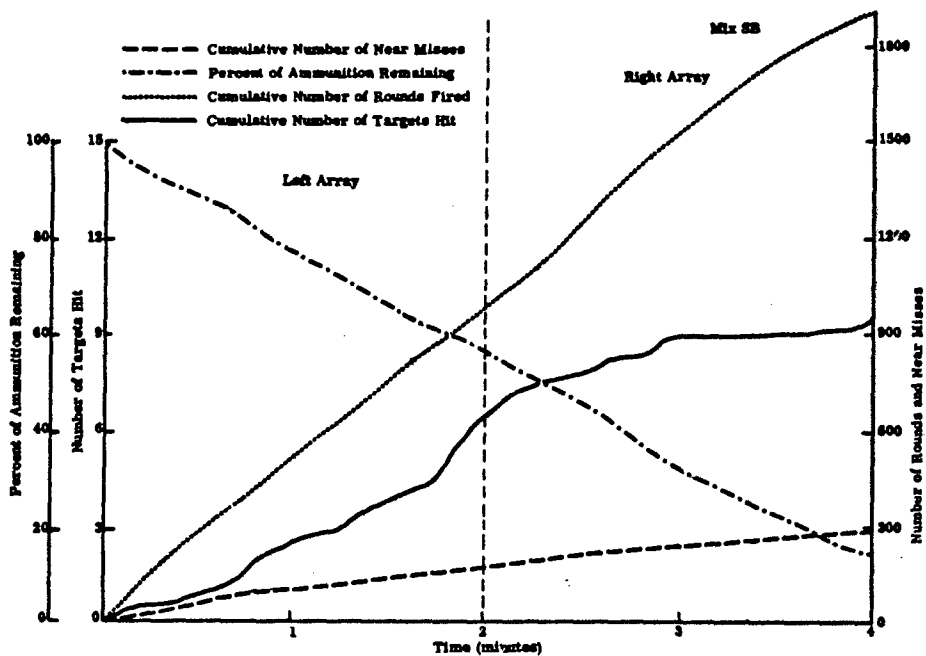
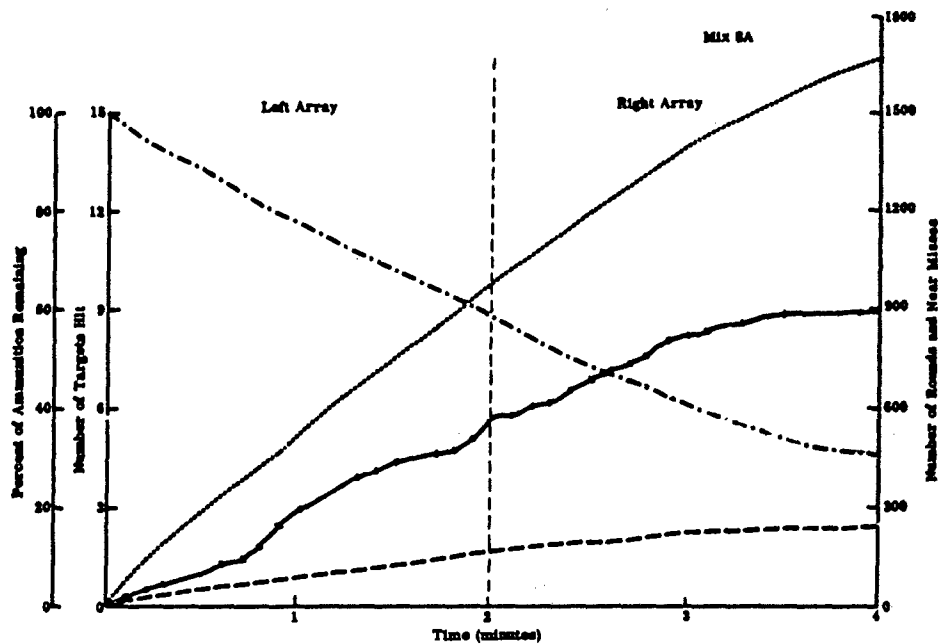

Figure 6-7 (Continued) CUMULATIVE NUMBER OF ROUNDS FIRED, TARGETS HIT, NEAR MISSES, AND PERCENT OF AMMUNITION REMAINING--SITUATION 2

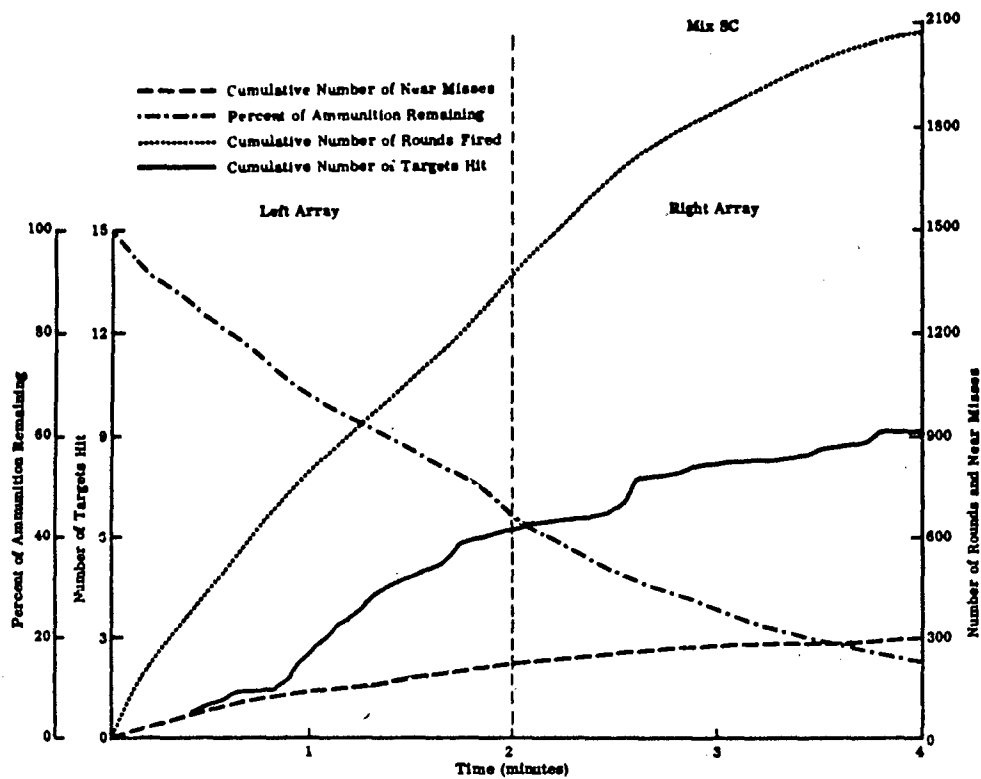

Figure 6-7 (Continued) CUMULATIVE NUMBER OF ROUNDS FIRED, TARGETS HIT, NEAR MISSES, AND PERCENT OF AMMUNITION REMAINING--SITUATION 2

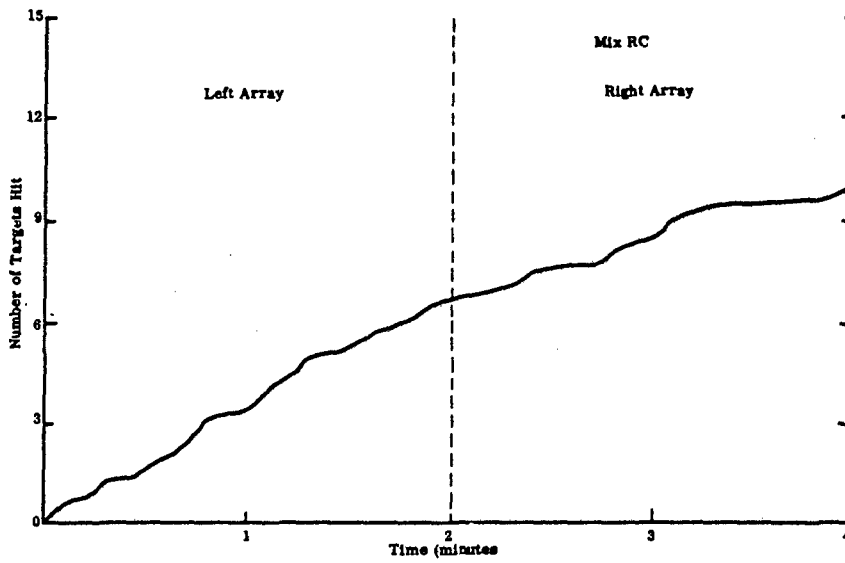
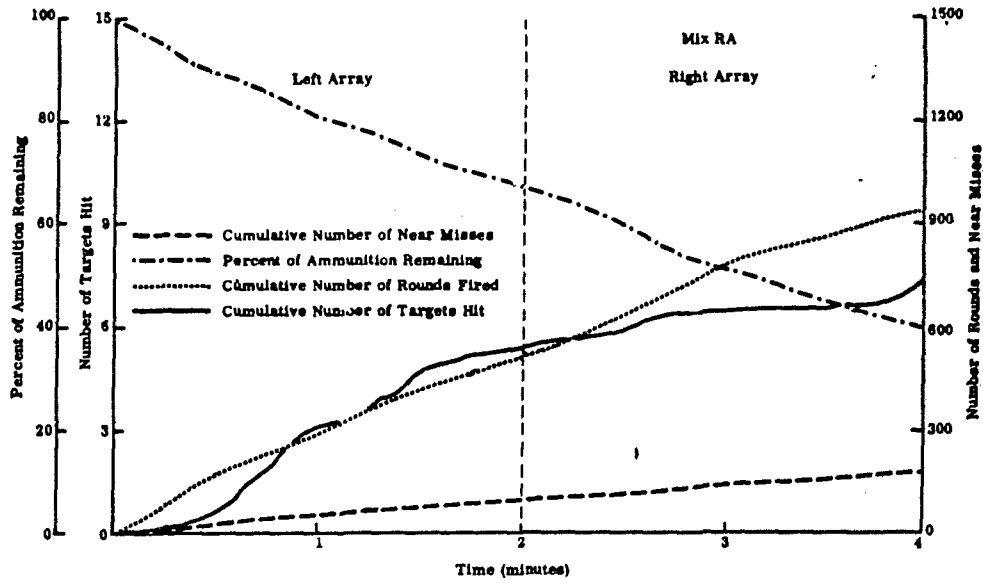

Figure 6-7 (Concluded) CUMULATIVE NUMBER OF ROUNDS FIRED, TARGETS HIT, NEAR MISSES, AND PERCENT OF AMMUNITION REMAINING--SITUATION 2

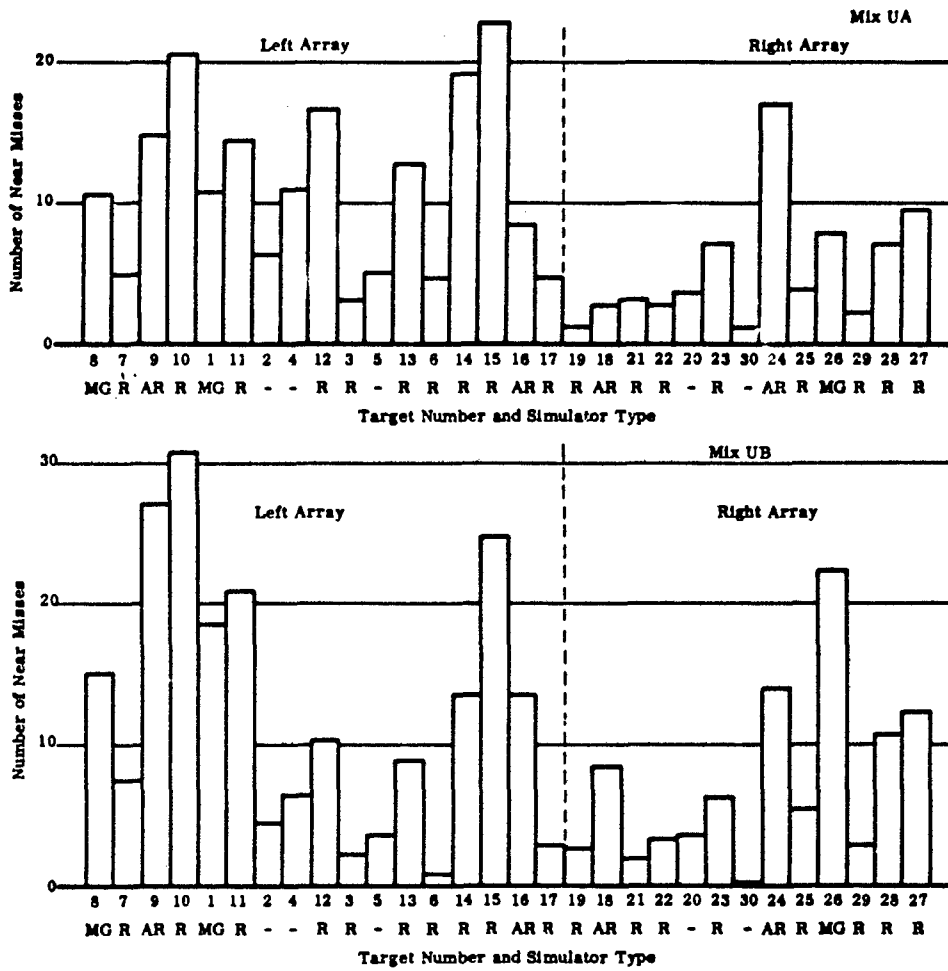
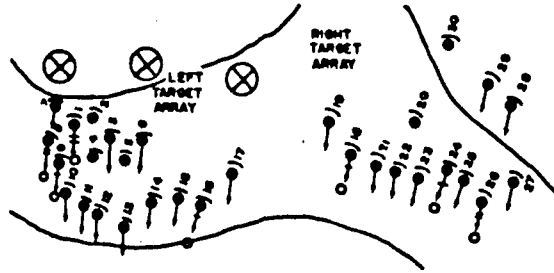

Figure 6-8  
NUMBER AND DISTRIBUTION OF NEAR MISSES--SITUATION 2

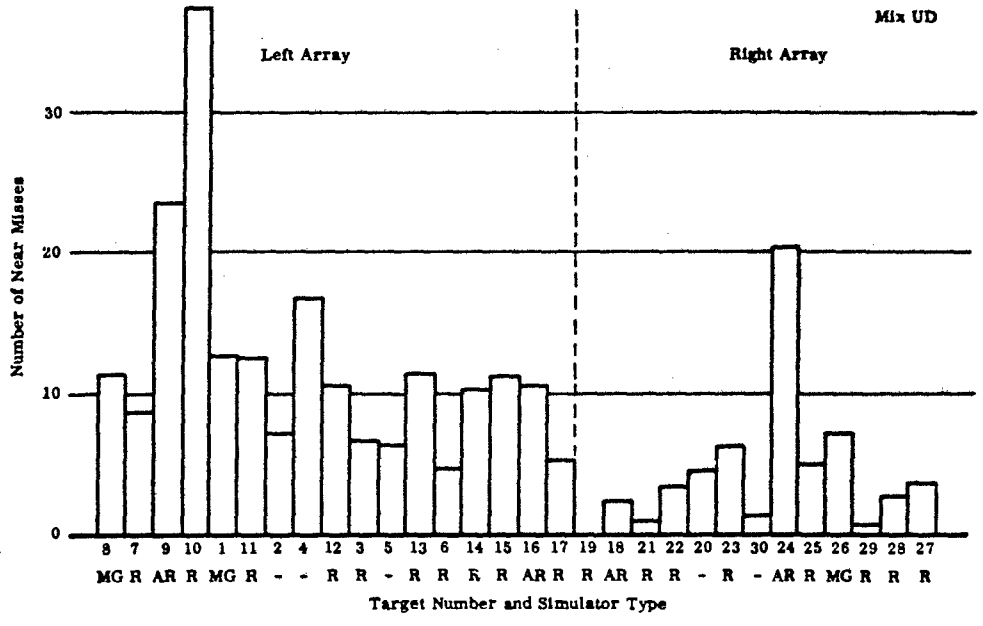
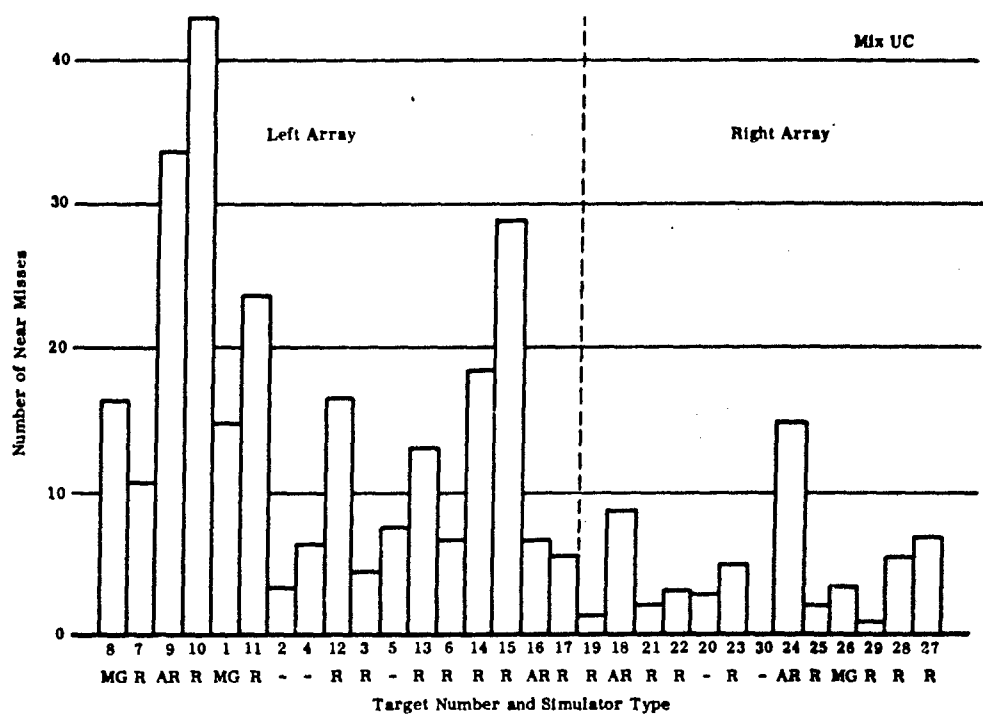

Figure 6-8 (Continued)  
 NUMBER AND DISTRIBUTION OF NEAR MISSES--SITUATION 2



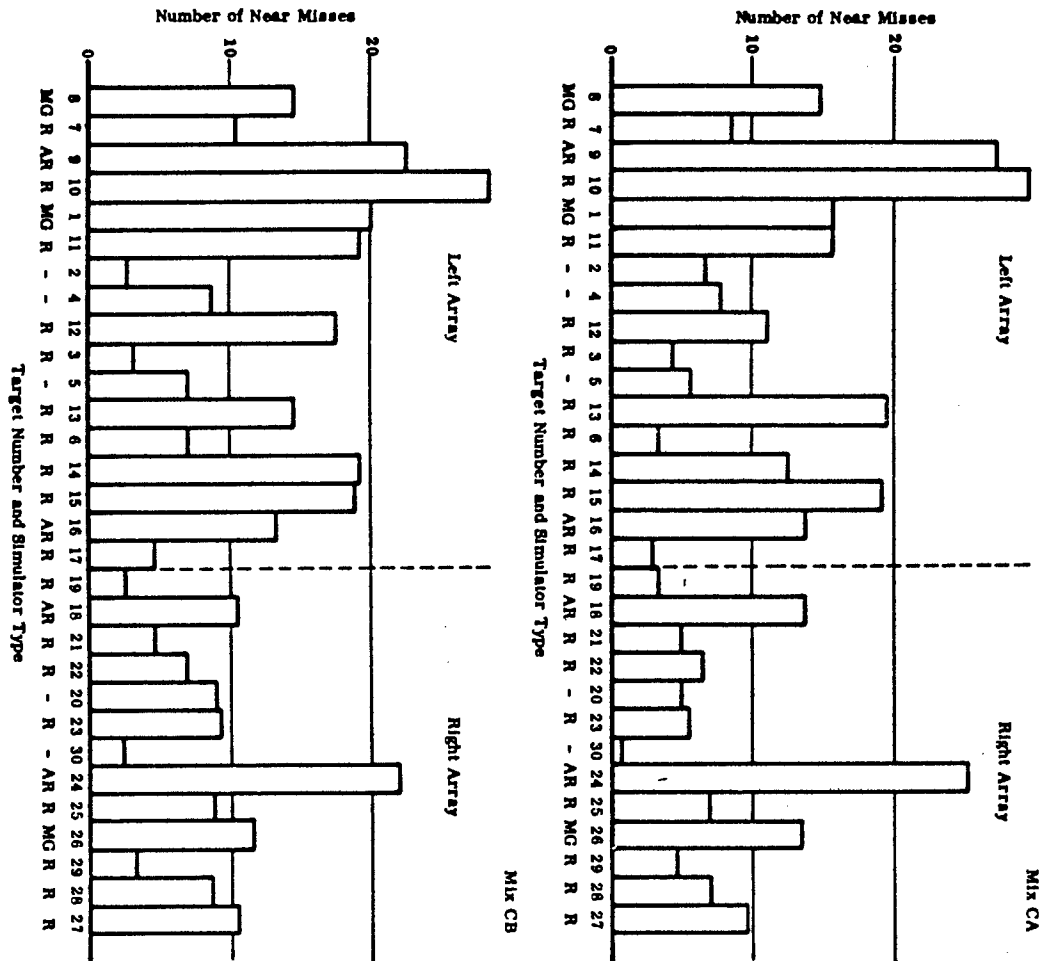
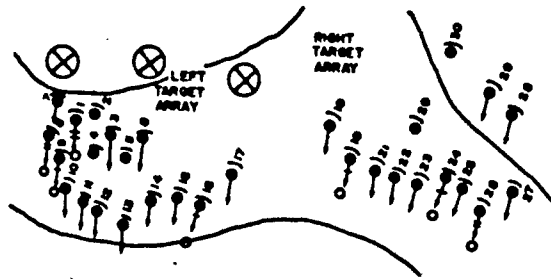

Figure 6-8 (Continued)  
 NUMBER AND DISTRIBUTION OF NEAR MISSES--SITUATION 2

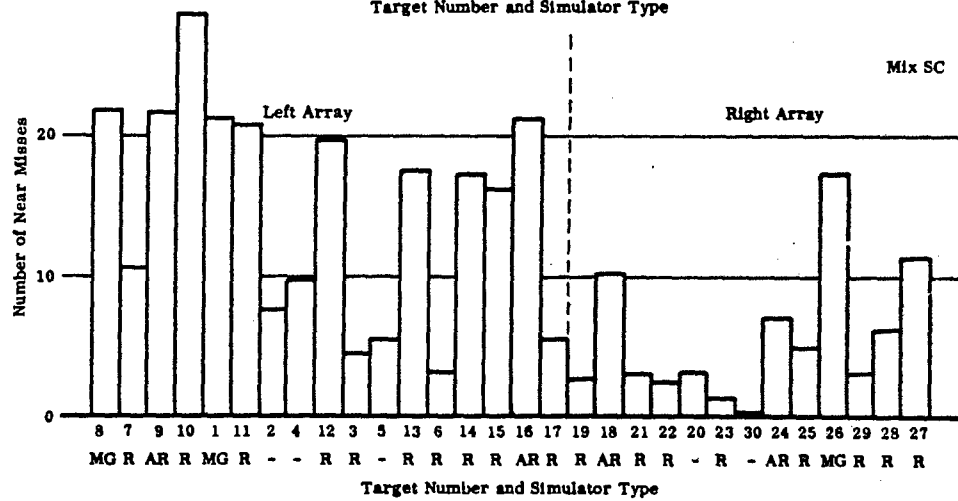
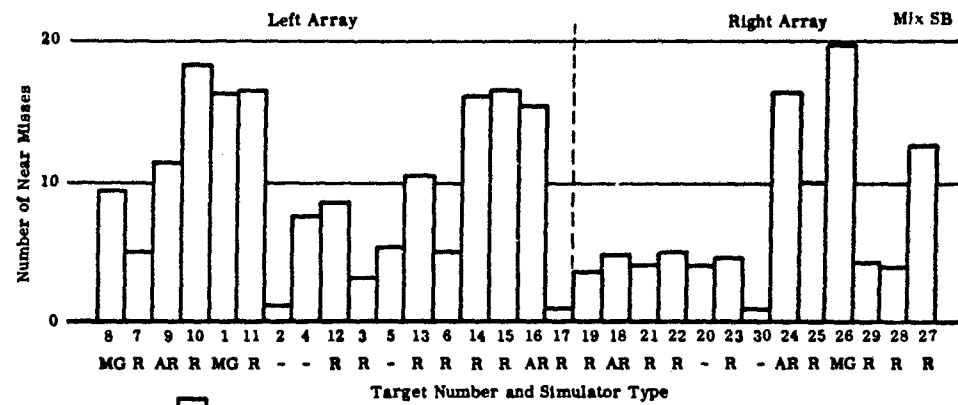
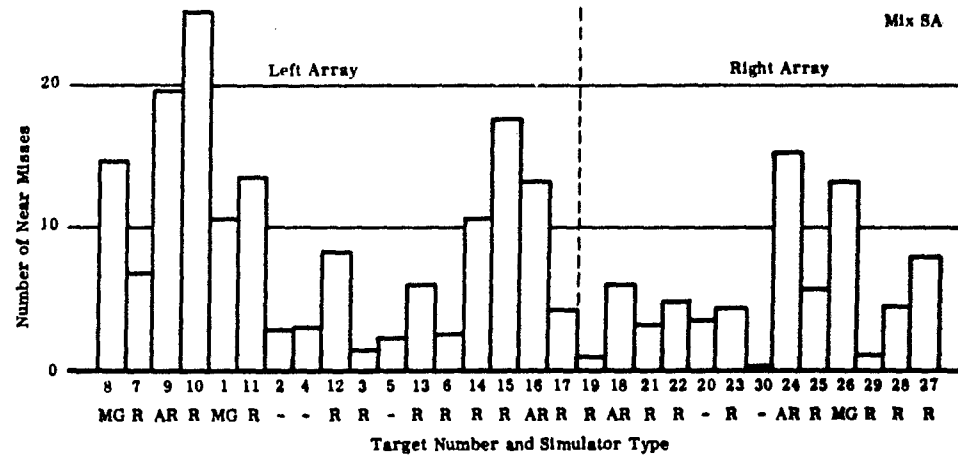

Figure 6-8 (Continued)

NUMBER AND DISTRIBUTION OF NEAR MISSES--SITUATION 2

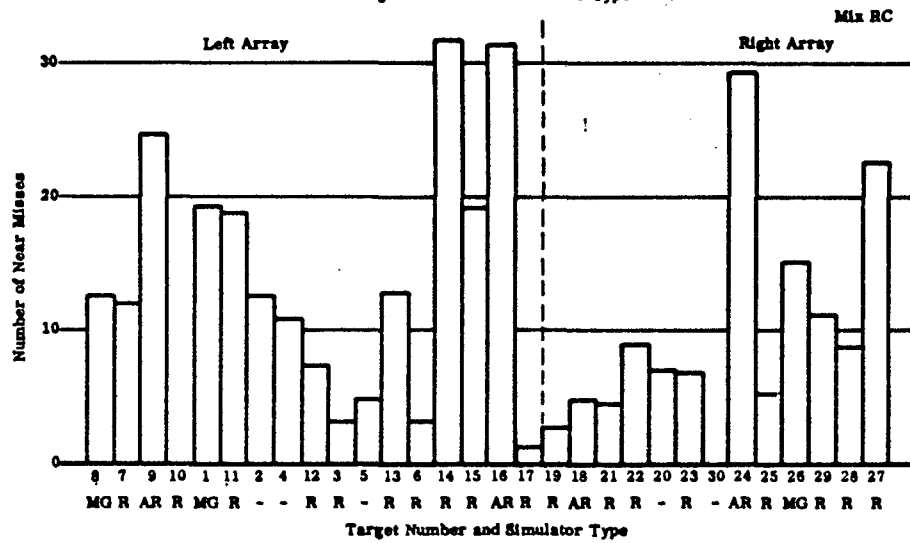
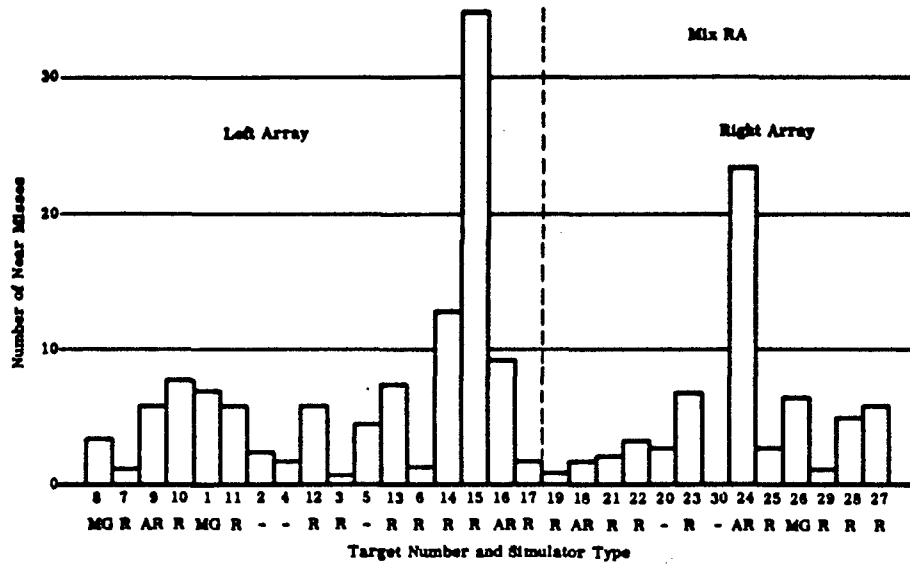
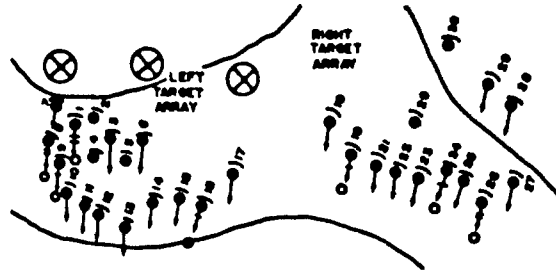

Figure 6-8 (Concluded)  
 NUMBER AND DISTRIBUTION OF NEAR MISSES--SITUATION 2

**3. Situation 4: Rifle Squad in Approach to Contact**

The approach to contact situation evaluated rifle squad weapon mixes in standing quickfire. This situation, in which the firers were time stressed, was designed to evaluate the pointing characteristics of small arms. It consisted of 40 targets programmed to appear in 12 events (or groups) of one to ten targets each. The 12 target groups were deployed at various points along a valley 430 meters long. The range from targets to the firers was 19 to 180 meters. Programmed target exposure times ran from 2 seconds to 10 seconds for some of the longer range targets (beyond 100 meters). Total programmed cumulative exposure time for all 40 targets was 2.996 minutes. The time required for each squad to complete the approach to contact course was 25 to 30 minutes.

Results are presented in subtables and graphically for cumulative exposure times, sustainability, number of targets hit, and number of total hits, across all events in Figure 6-9. Cumulative hits and percent of ammunition remaining as a function of time by range and event are presented in Figure 6-10. In addition, three sets of tables are presented, listing the rank order and associated standard scores for the following measures.

Table a -- Rank order of weapon mixes and associated standard scores for sum of target effects across all 12 events. This weights the event by range and number of targets unequally.

Table b -- Rank order of weapon mixes and associated standard scores with all events weighted equally. In effect, this table represents the average of the standard scores computed for each event, where Table a represents the standard scores computed from the sum of raw scores across all 40 targets (12 events).

Table c -- Rank order of weapon mixes and associated standard scores for the ambush situation (ten enemy targets at a range of 21 to 34 meters).

**Table a. SUM OF RAW SCORES ACROSS ALL TARGETS  
(Events Weighted Unequally)**

Target Effects Only			Overall Effectiveness*		
Rank	Mix	Standard Score	Rank	Mix	Standard Score
1	SC	61.4	1	CA	62.5
2	CA	59.3	2	UA	56.7
3	SB	52.8	3	RA	54.4
4	UA	51.7	4	SC	53.7
5	RA	50.6	5	CB	53.4
6	UB	49.6	6	SB	52.6
7	CB	45.2	7	UB	51.7
8	UD	44.2	8	SA	46.9
9	SA	44.2	9	UC	35.1
10	UC	40.9	10	UD	33.0

**Table b. AVERAGE OF 12 EVENT STANDARD SCORES  
(Events Weighted Equally)**

Target Effects Only			Overall Effectiveness*		
Rank	Mix	Standard Score	Rank	Mix	Standard Score
1	CA	62.9	1	CA	64.5
2	SC	57.0	2	UA	57.5
3	UA	54.4	3	UB	53.9
4	UB	53.4	4	SB	51.6
5	SB	51.3	5	RA	51.6
6	SA	46.7	6	SC	51.5
7	RA	46.4	7	CB	50.8
8	UD	44.2	8	SA	48.5
9	CB	42.4	9	UD	35.2
10	UC	41.5	10	UC	34.7

\* Sustainability weighted 1/3; Target effects 2/3

Table c. AMBUSH EVENT (10 TARGETS - 21 to 34 METERS)

Target Effects Only			Overall Effectiveness*		
Rank	Mix	Standard Score	Rank	Mix	Standard Score
1	SC	61.8	1	SC	59.6
2	UA	53.9	2	RA	56.0
3	SB	52.4	3	UA	55.7
4	SA	51.4	4	CA	55.6
5	UB	51.2	5	SA	52.7
6	CB	50.3	6	SB	52.1
7	CA	48.9	7	CB	52.0
8	RA	48.5	8	UB	48.6
9	UD	45.4	9	UD	43.5
10	UC	37.4	10	UC	25.0

\* Sustainability weighted 1/3; Target effects 2/3

Key:

- |                                     |   |
|-------------------------------------|---|
| UA - 9 M14 Rifles                   | SB - 7 Stoner Rifles and<br>2 Stoner AR |
| UD - 9 M14E2 Rifles                 | SC - 7 Stoner Rifles and<br>2 Stoner MG |
| UB - 7 M14 Rifles and<br>2 M14E2 AR | CA - 9 Colt Rifles                      |
| UC - 5 M14 Rifles and<br>2 M60 MG   | CB - 7 Colt Rifles and<br>2 Colt AR     |
| SA - 9 Stoner Rifles                | RA - 9 AK47 Rifles                      |

Mix RC results for Situation 4 are presented below.

CET	Near Misses	Percent Ammo Remaining	Targets Hit	Total Hits
2.17	--	52.00	26.66	38.60

EFFECTIVENESS MEASURES

COLLATERAL

**A Cumulative Exposure Times**

Mix	$\bar{X}$ CET	SD	Standard Score $Z'$
SC	1.95	.1	61.4
CA	1.97	.2	59.3
SB	2.03	.1	52.8
UA	2.04	.1	51.7
RA	2.05	.2	50.6
UB	2.06	.1	49.6
CB	2.10	.1	45.2
UD	2.11	.1	44.2
SA	2.11	.1	44.2
UC	2.14	.2	40.9
$\bar{X}$	2.06		
SD	.03		

**B Number of Near Misses**

Mix	$\bar{X}$ Near Misses	SD	Standard Score $Z'$
SC			
CA			
SB			
UA			
RA			
UB			
CB			
UD			
SA			
UC			
$\bar{X}$			
SD			

**C Sustainability (% Ammo Remaining)**

Mix	$\bar{X}$ % Remaining	SD	Standard Score $Z'$
CB	80.8	5.6	65.6
CA	80.2	4.8	68.8
UA	78.7	4.8	66.8
RA	75.8	2.8	62.1
UB	71.7	6.2	55.9
SA	69.3	5.7	52.2
SB	69.2	9.9	52.1
SC	60.2	7.4	38.3
UC	50.5	22.8	23.6
UD	42.0	9.0	10.8
$\bar{X}$	67.8		
SD	13.11		

**D Number of Targets Hit**

Mix	$\bar{X}$ Targets Hit	SD	Standard Score $Z'$
SC	30.8	2.3	57.0
UB	30.7	2.1	56.5
SB	30.5	1.1	55.4
CA	30.4	2.3	54.9
UA	30.0	2.4	52.8
RA	29.8	4.3	51.7
SA	29.2	.9	48.8
UD	27.9	4.7	41.6
UC	27.8	2.8	41.0
CB	27.7	2.7	40.5
$\bar{X}$	29.48		
SD	3.75		

**F Target Effects**

Mix	Standard Score Target Effects
SC	61.4
CA	59.3
SB	52.8
UA	51.7
RA	50.6
UB	49.6
CB	45.2
UD	44.2
SA	44.2
UC	40.9

**G Overall Effectiveness**

Mix	Overall Fire Effectiveness
CA	62.5
UA	56.7
RA	54.4
SC	53.7
CB	53.4
SB	52.6
UB	51.7
SA	46.9
UC	35.1
UD	33.0

**H Cumulative Exposure Times**

	SC	CA	SB	UA	RA	UB	CB	UD	SA	UC
SC		>.40	.10	.13	.14	.09	.03	.02	.02	.05
CA			.28	.26	.26	.22	.11	.09	.09	.11
SB				>.40	.38	.33	.12	.06	.04	.14
UA					>.40	>.40	.22	.18	.16	.19
RA						>.40	.30	.26	.25	.26
UB							.27	.22	.20	.22
CB								>.40	>.40	.37
UD									>.40	.39
SA										.39

**I**

**J Sustainability (% Ammo Remaining)**

	CB	CA	UA	RA	UB	SA	SB	SC	UC	UD
CB		>.40	.25	.05	.01	.004	.02	.001	.01	.001
CA			.30	.05	.02	.004	.02	.001	.01	.001
UA				.14	.03	.01	.03	.001	.01	.001
RA					.10	.02	.09	.001	.02	.001
UB						.26	.31	.01	.03	.001
SA							>.40	.02	.04	.001
SB								.05	.05	.001
SC									.17	.003
UC										.21

**K No. of Targets Hit**

	SC	UB	SB	CA	UA	RA	SA	UC	UD	CB
SC		>.40	.37	.37	.28	.32	.08	.11	.04	.03
UB			>.40	.40	.30	.34	.08	.12	.04	.04
SB				>.40	.33	.37	.03	.12	.03	.03
CA					>.40	>.40	.14	.14	.06	.05
UA						>.40	.24	.19	.09	.08
RA							.37	.26	.18	.18
SA								.27	.14	.12
UC									>.40	>.40
UD										>.40

**L**

Note: Standard Scores computed from raw scores using scores to three decimal places.

- UA - 9 M14 Rifles
- UB - 7 M14 Rifles/2 M14E2 AR
- UC - 5 M14 Rifles/2 M60 MG
- UD - 9 M14E2 Rifles
- CA - 9 Colt Rifles
- CB - 7 Colt Rifles/2 Colt AR
- SA - 9 Stoner Rifles
- SB - 7 Stoner Rifles/2 Stoner AR
- SC - 7 Stoner Rifles/2 Stoner MG
- RA - 9 AK47 Rifles

$\bar{X}$   
SD  
CET  
 $Z'$





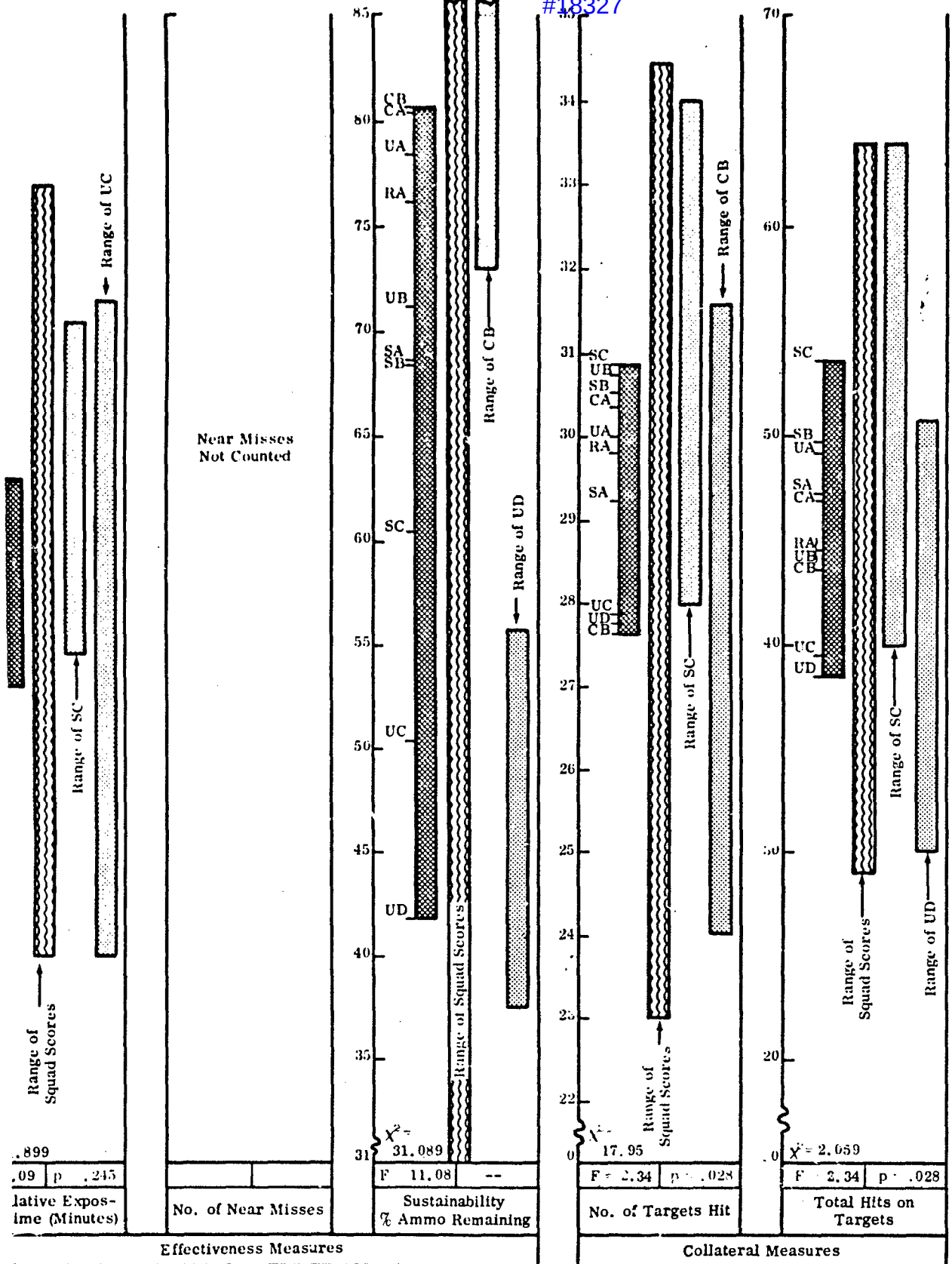

Figure 6-9 SUMMARY OF RESULTS--SITUATION 4

3

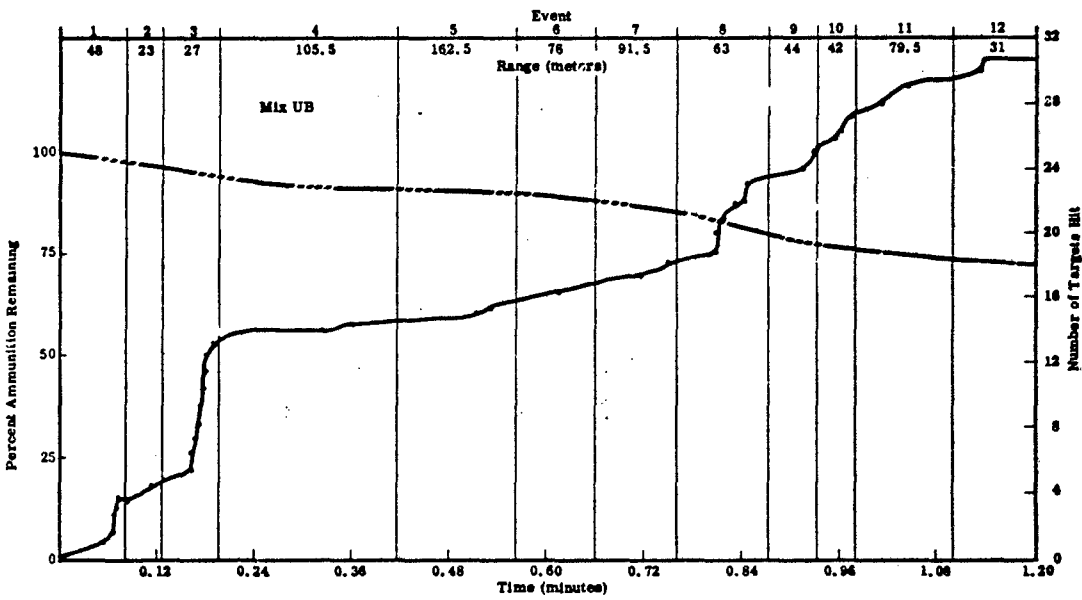
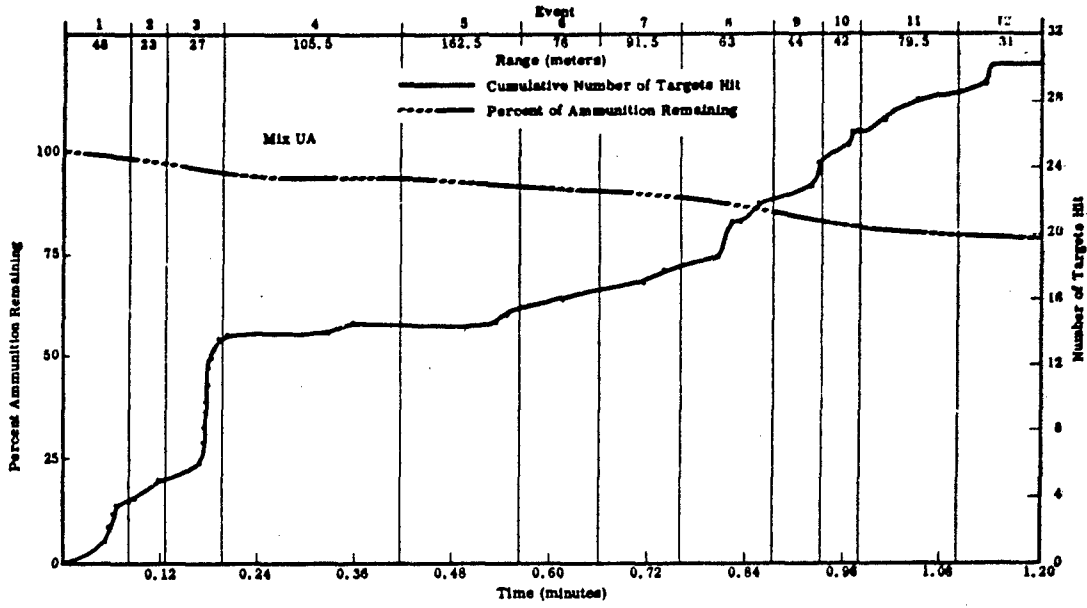

Figure 6-10 CUMULATIVE NUMBER OF TARGETS HIT AND PERCENT OF AMMUNITION REMAINING--SITUATION 4

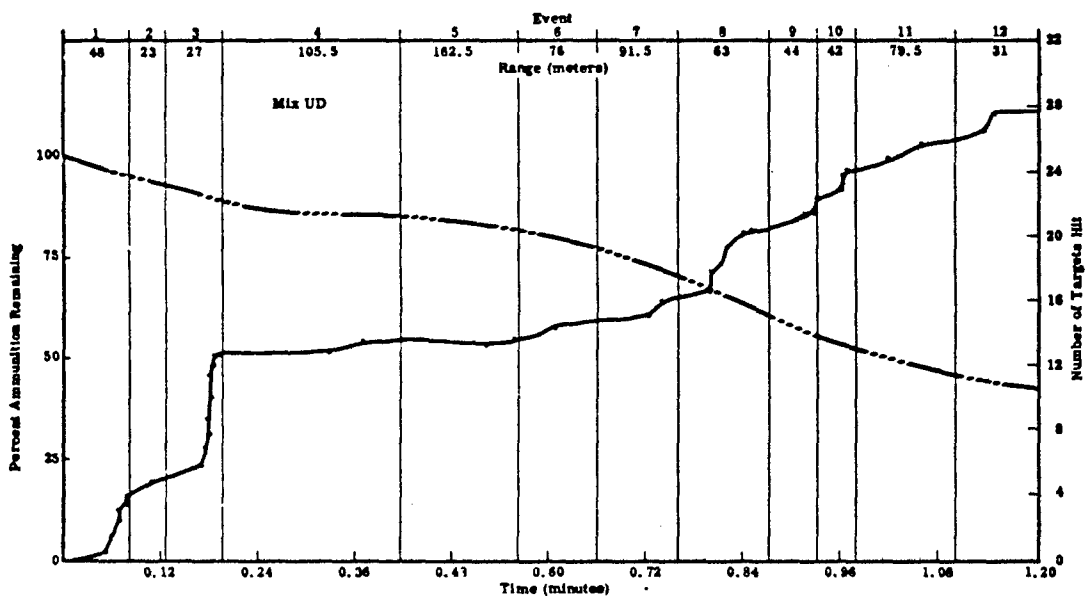
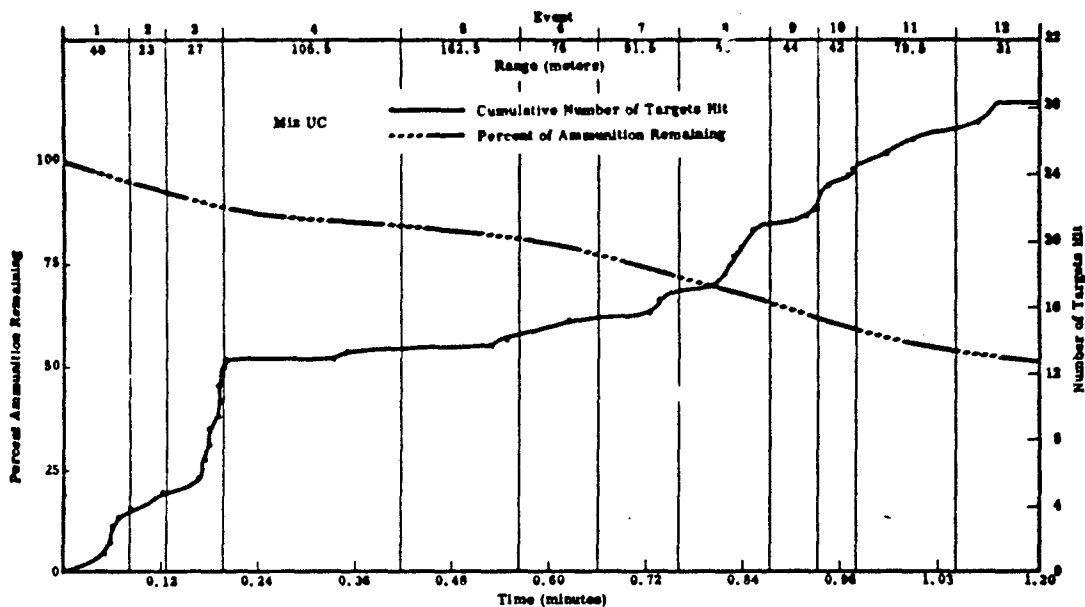

Figure 6-10 (Continued) CUMULATIVE NUMBER OF TARGETS HIT AND PERCENT OF AMMUNITION REMAINING--SITUATION 4

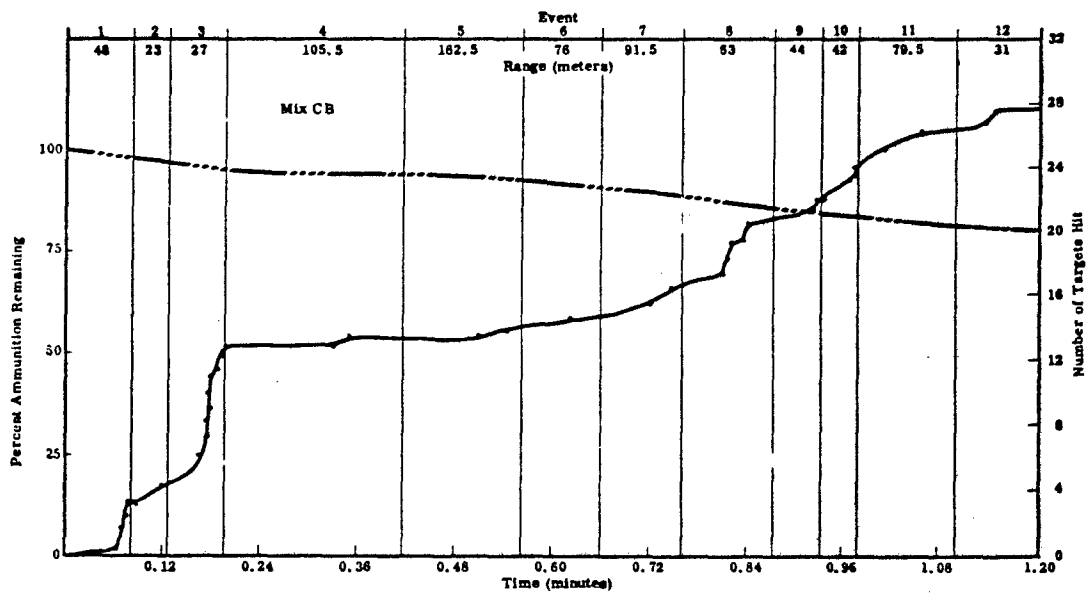
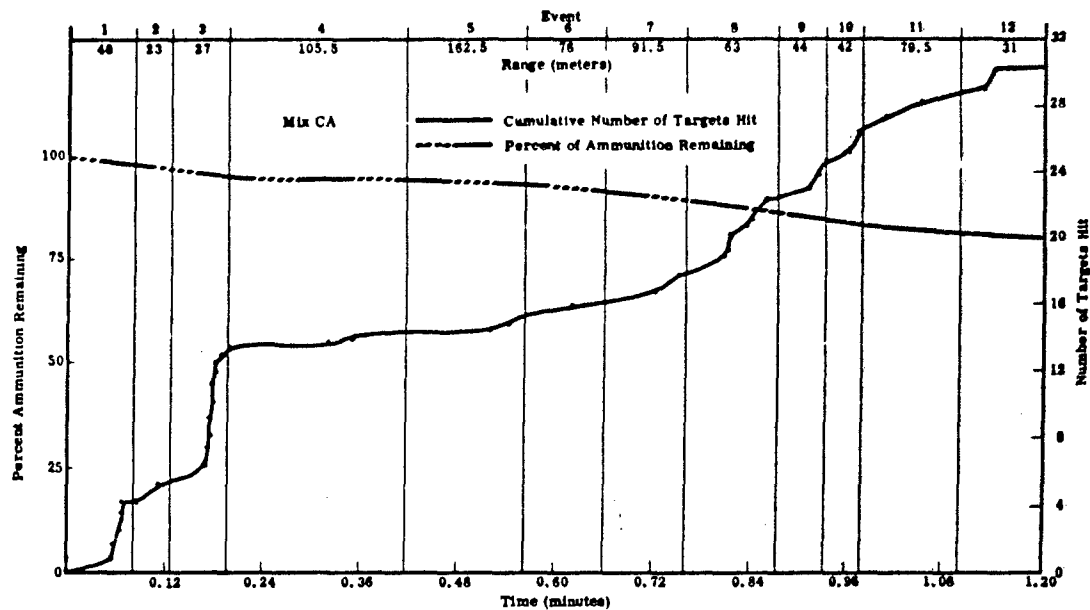

Figure 6-10 (Continued) CUMULATIVE NUMBER OF TARGETS HIT AND PERCENT OF AMMUNITION REMAINING--SITUATION 4

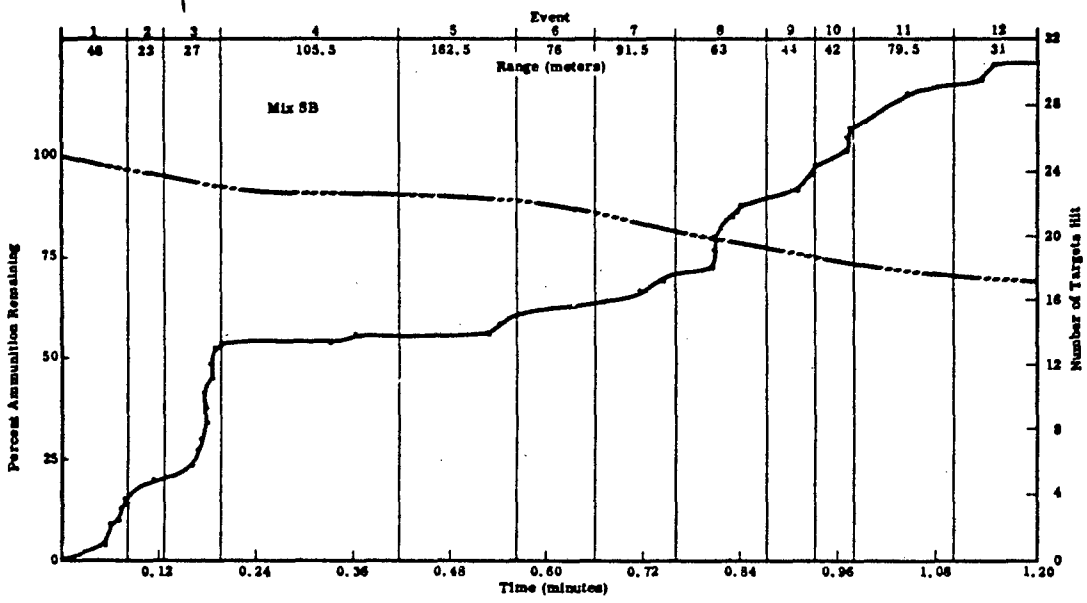
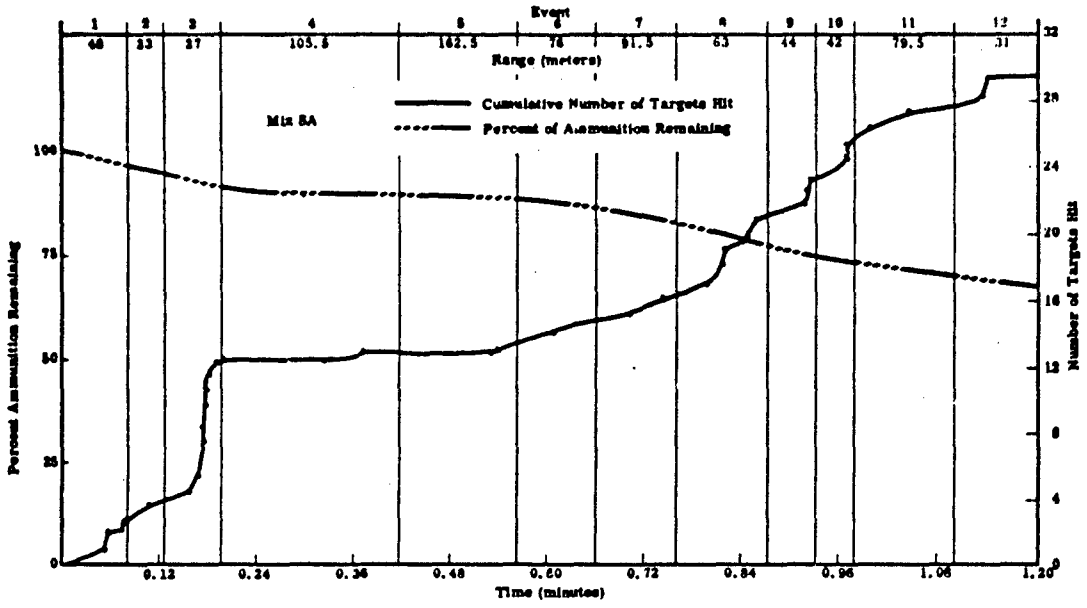

Figure 6-10 (Continued) CUMULATIVE NUMBER OF TARGETS HIT AND PERCENT OF AMMUNITION REMAINING--SITUATION 4

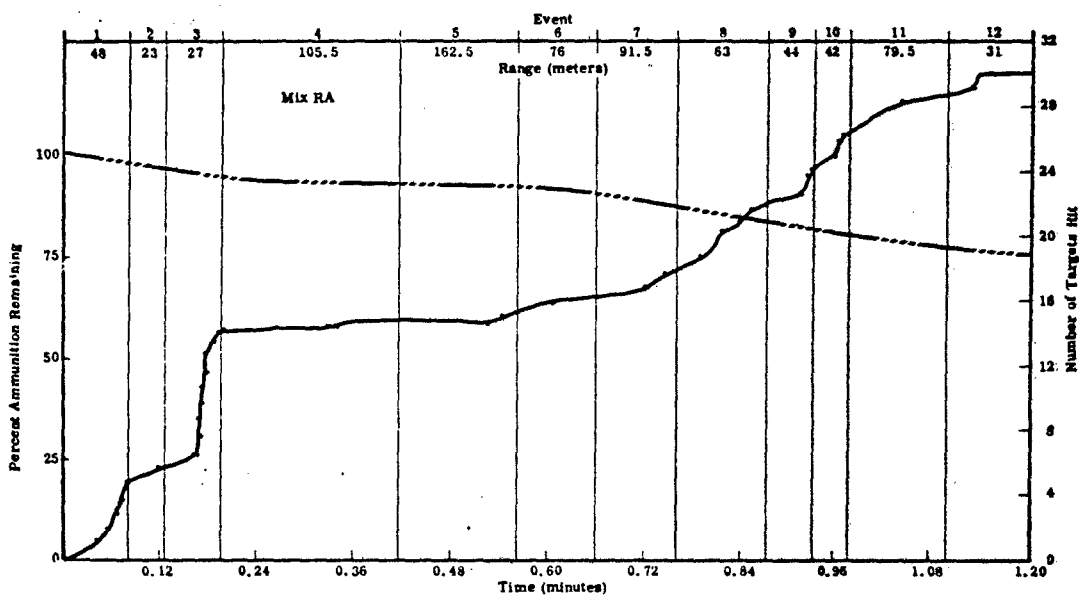
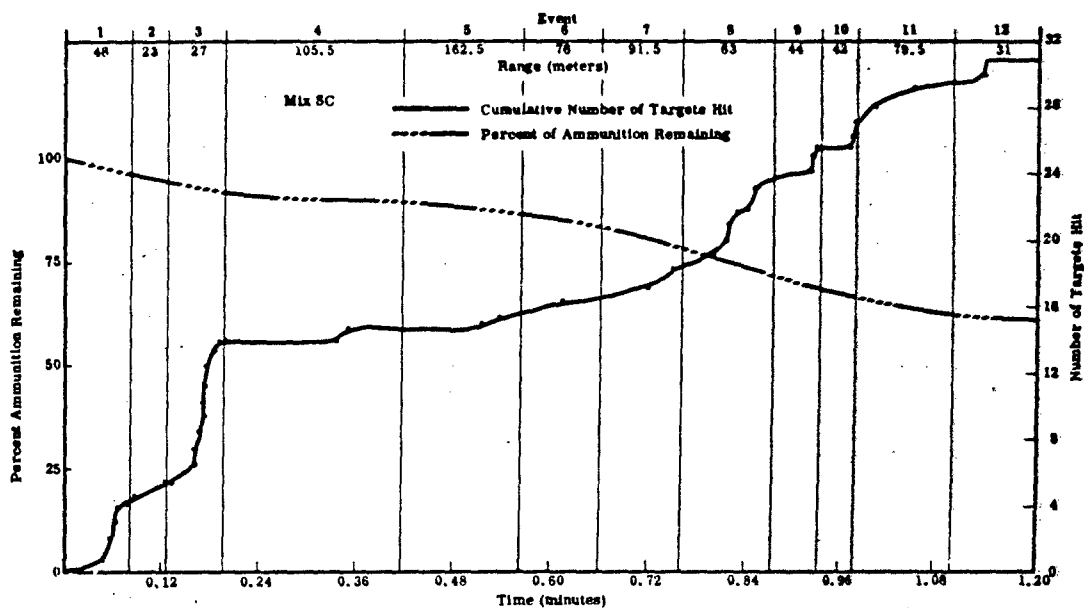

Figure 6-10 (Concluded) CUMULATIVE NUMBER OF TARGETS HIT AND PERCENT OF AMMUNITION REMAINING--SITUATION 4

4. Situation 5: Rifle Squad as a Base of Fire Supporting the Advance

Rifle squad weapon mixes fired from unprepared firing positions on two arrays of enemy targets. The duration of fire was 4 minutes, with the first 2 minutes devoted to an array of 14 enemy targets occupying an area 60 meters wide and 42 meters deep. The range of targets from the firers was 379 to 445 meters. The second 2 minutes of fire were delivered on an array of 13 targets occupying an area 45 meters wide and 62 meters deep, at ranges from the firers of 477 to 560 meters. The technique of distributed fire was used throughout the sector, with point fire used when targets were seen or weapon simulators gave specific cues to a target's location.

Arrays X and Y are presented separately following the overall results for the two arrays combined.

Results for Situation 5 are tabulated and presented graphically in Figures 6-11, 6-12, and 6-13. Figure 6-14 shows plots of cumulative average first hits as a function of time. For Mix RC, only cumulative number of hits is presented. Figure 6-15 shows the distribution of near misses by target.

The rank order of the ten mixes (other than Mix RC) with associated standard scores are given below.

Target Effects Only			Overall Effectiveness*		
Rank	Mix	Standard Score	Rank	Mix	Standard Score
1	SA	82.6	1	SA	74.5
2	SB	66.9	2	CB	67.9
3	SC	63.6	3	SB	63.8
4	CB	63.4	4	SC	57.5
5	UA	48.7	5	CA	50.1
6	UD	46.7	6	UA	47.5
7	UC	41.8	7	UD	41.5
8	CA	31.6	8	UC	36.44
9	UB	27.6	9	RA	30.77
10	RA	27.3	10	UB	30.1

\* Sustainability weighted 1/3; Target effects 2/3

**Key:**

UA - 9 M14 Rifles	SB - 7 Stoner Rifles and 2 Stoner AR
UD - 9 M14E2 Rifles	SC - 7 Stoner Rifles and 2 Stoner MG
UB - 7 M14 Rifles and 2 M14E2 AR	CA - 9 Colt Rifles
UC - 5 M14 Rifles and 2 M60 MG	CB - 7 Colt Rifles and 2 Colt AR
SA - 9 Stoner Rifles	RA - 9 AK47 Rifles
RC - 7 AK47 Rifles and 2 RPD MG	

Mix RC results for Situation 5 are presented below.

CET	Near Misses	Percent Ammo Remaining	Targets Hit	Total Hits
41.41	167.80	51.60	5.72	6.12



**EFFECTIVENESS MEASURES**

Cumulative Exposure Times				Number of Near Misses				Sustainability (% Ammo Remaining)				
Mix	N	SD	Standard Score z'	Mix	N	SD	Standard Score z'	Mix	N	SD	Standard Score z'	Sustainability Time (Min)
SA	38.6	2.5	74.2	SA	207.3	43.4	90.9	CA	84.8	3.7	87.1	26.3
CB	38.6	3.3	74.0	SB	177.8	67.7	72.6	CB	79.0	4.9	77.1	19.0
SC	39.5	2.9	63.1	SC	164.2	63.0	64.1	SA	68.0	9.6	58.3	12.5
SB	39.7	4.3	61.2	CB	145.8	31.7	52.7	SB	67.6	8.1	57.6	12.3
UA	40.2	4.2	54.3	UA	130.3	51.6	43.1	SC	60.4	12.6	45.3	10.1
UD	40.3	2.4	53.2	UD	125.5	40.3	40.1	UA	60.3	5.4	45.1	10.1
UC	40.7	2.4	48.6	CA	121.5	51.5	37.6	RA	55.9	9.6	37.6	9.1
UB	42.5	2.2	27.2	RA	119.0	43.8	36.0	UB	54.4	4.3	35.1	8.8
CA	42.6	3.2	25.5	UC	117.1	29.7	34.9	UD	52.1	2.7	31.2	8.4
RA	43.2	2.3	18.5	UB	106.2	34.4	28.0	UC	48.8	10.3	25.6	7.8
$\bar{X}$	40.60			$\bar{X}$	141.48			$\bar{X}$	63.12			
$\sigma$	1.65			$\sigma$	32.17			$\sigma$	11.73			

**COLLATERAL PERFORMANCE**

Number of Targets Hit				Total
Mix	N	SD	Standard Score z'	Mix
SA	8.9	1.7	79.1	SA
CB	8.3	3.2	71.7	SB
SC	7.9	2.9	67.2	CB
SB	7.7	2.8	64.0	SC
UD	6.5	2.5	50.0	UD
UA	6.4	3.1	47.9	UA
UC	5.6	2.2	38.8	UC
CA	5.1	4.1	31.9	CA
UB	5.0	2.5	31.0	UB
RA	4.0	2.2	18.6	RA
$\bar{X}$	6.54			$\bar{X}$
$\sigma$	1.62			$\sigma$

**Target Effects**

Mix	Standard Score Target Effects
SA	82.5
SB	66.9
SC	63.6
CB	63.3
UA	48.7
UD	46.7
UC	41.7
CA	31.5
UB	27.6
RA	27.3

**Overall Effectiveness**

Mix	Overall Fire Effectiveness
SA	74.5
CB	67.9
SB	63.8
SC	57.5
UA	50.1
UD	47.5
UC	41.5
RA	36.4
UB	30.7
UB	30.1

**Cumulative Exposure Time**

	SA	CB	SC	SB	UA	UD	UC	UB	CA	RA
SA	>.40	.39	.31	.22	.13	.09	.01	.02	.008	
CB		.31	.32	.23	.16	.12	.02	.03	.02	
SC			>.40	.37	.30	.22	.04	.05	.02	
SB				>.40	.37	.31	.09	.10	.07	
UA					>.40	>.40	.14	.15	.10	
UD						>.40	.07	.10	.04	
UC							>.40	.11	.14	.06
UB								>.40	.31	
CA									>.40	.37

**Number of Near Miss**

	SA	SB	SC	CB	UA	UD	C
SA		.19	.10	.01	.01	.004	.04
SB			.36	.16	.10	.07	.07
SC				.27	.17	.12	.1
CB					.27	.18	.1
UA						>.40	.3
UD							>.4
UC							
CA							
RA							
UC							

**Sustainability (% Ammo Remaining)**

	CA	CB	SA	SB	SC	UA	RA	UB	UD	UC
CA		.02	.002	.000	.001	.000	.001	.000	.000	.000
CB			.02	.009	.004	.000	.001	.000	.000	.000
SA				>.40	.13	.05	.03	.004	.002	.004
SB					.13	.05	.03	.004	.000	.004
SC						>.40	.26	.15	.08	.06
UA							.18	.03	.005	.02
RA								.37	.19	.14
UB									.15	.13
UD										.24

**No. of Targets Hit**

	SA	CB	SC	SB	UD	UA	UC	CA	UB	RA
SA		.35	.25	.19	.04	.06	.01	.03	.005	.003
CB			>.40	.36	.16	.16	.07	.09	.04	.02
SC				>.40	.19	.19	.08	.10	.05	.02
SB					.24	.23	.10	.12	.06	.02
UD						>.40	.26	.24	.15	.06
UA							.33	.28	.21	.10
UC								.39	.33	.13
CA									>.40	.31
UB										.26

**Total Hits on Target**

	SA	SB	CB	SC	UD	UA	I
SA		.24	.15	.15	.02	.02	.0
SB			>.40	>.40	.15	.13	.0
CB				>.40	.16	.14	.0
SC					.17	.15	.0
UD						>.40	.1
UA							.1
UC							
CA							
UB							

Note: Standard Scores computed from raw scores using scores to three decimal places.

UA - 9 M14 Rifles  
 UB - 7 M14 Rifles/2 M14E2 AR  
 UC - 5 M14 Rifles/2 M60 MG  
 UD - 9 M14E2 Rifles  
 CA - 9 Colt Rifles

CB - 7 Colt Rifles/2 Colt AR  
 SA - 9 Stoner Rifles  
 SB - 7 Stoner Rifles/2 Stoner AR  
 SC - 7 Stoner Rifles/2 Stoner MG  
 RA - 9 AK47 Rifles

$\bar{X}$  - Mean (Average)  
 SD - Standard Devia  
 CET - Cumulative Ex  
 z' - Standard Score

**COLLATERAL PERFORMANCE MEASURES**

Number of Targets Hit				Total Hits on Targets			
Mix	X Targets Hit	SD	Standard Score z'	Mix	X Hits	SD	Standard Score z'
SA	8.9	1.7	79.1	SA	10.2	2.4	93.2
CB	8.3	3.2	71.7	SB	8.8	3.9	69.2
SC	7.9	2.9	67.2	CB	8.5	3.2	65.6
SB	7.7	2.8	64.0	SC	8.4	3.3	65.2
UD	6.5	2.5	50.0	UD	6.7	2.7	47.9
UA	6.4	3.1	47.9	UA	6.4	3.1	44.6
UC	5.6	2.2	38.8	UC	5.6	2.2	37.2
CA	5.1	4.1	31.9	CA	5.2	4.3	33.2
UB	5.0	2.5	31.0	UB	5.0	2.5	30.9
RA	4.0	2.3	18.6	RA	4.3	2.3	22.9
$\bar{X}$	6.54			$\bar{X}$	6.91		
$\sigma$	1.62			$\sigma$	1.98		

**Number of Near Misses**

	SA	SB	SC	CB	UA	UD	CA	RA	UC	UB
SA		.19	.10	.01	.01	.004	.006	.005	.002	.001
SB			.36	.16	.10	.07	.07	.07	.04	.02
SC				.27	.17	.12	.12	.11	.07	.04
CB					.27	.18	.18	.14	.07	.03
UA						>.40	.39	.35	.30	.18
UD							>.40	>.40	.35	.20
CA								>.40	>.40	.28
RA									>.40	.30
UC										.28

**Total Hits on Targets**

	SA	SB	CB	SC	UD	UA	UC	CA	UB	RA
SA		.24	.15	.15	.02	.02	.004	.02	.03	.02
SB			>.40	>.40	.15	.13	.06	.08	.04	.02
CB				>.40	.16	.14	.05	.09	.03	.02
SC					.17	.15	.06	.09	.04	.02
UD						>.40	.24	.25	.14	.07
UA							.33	.31	.21	.12
UC								>.40	.33	.16
CA									>.40	.32
UB										.30

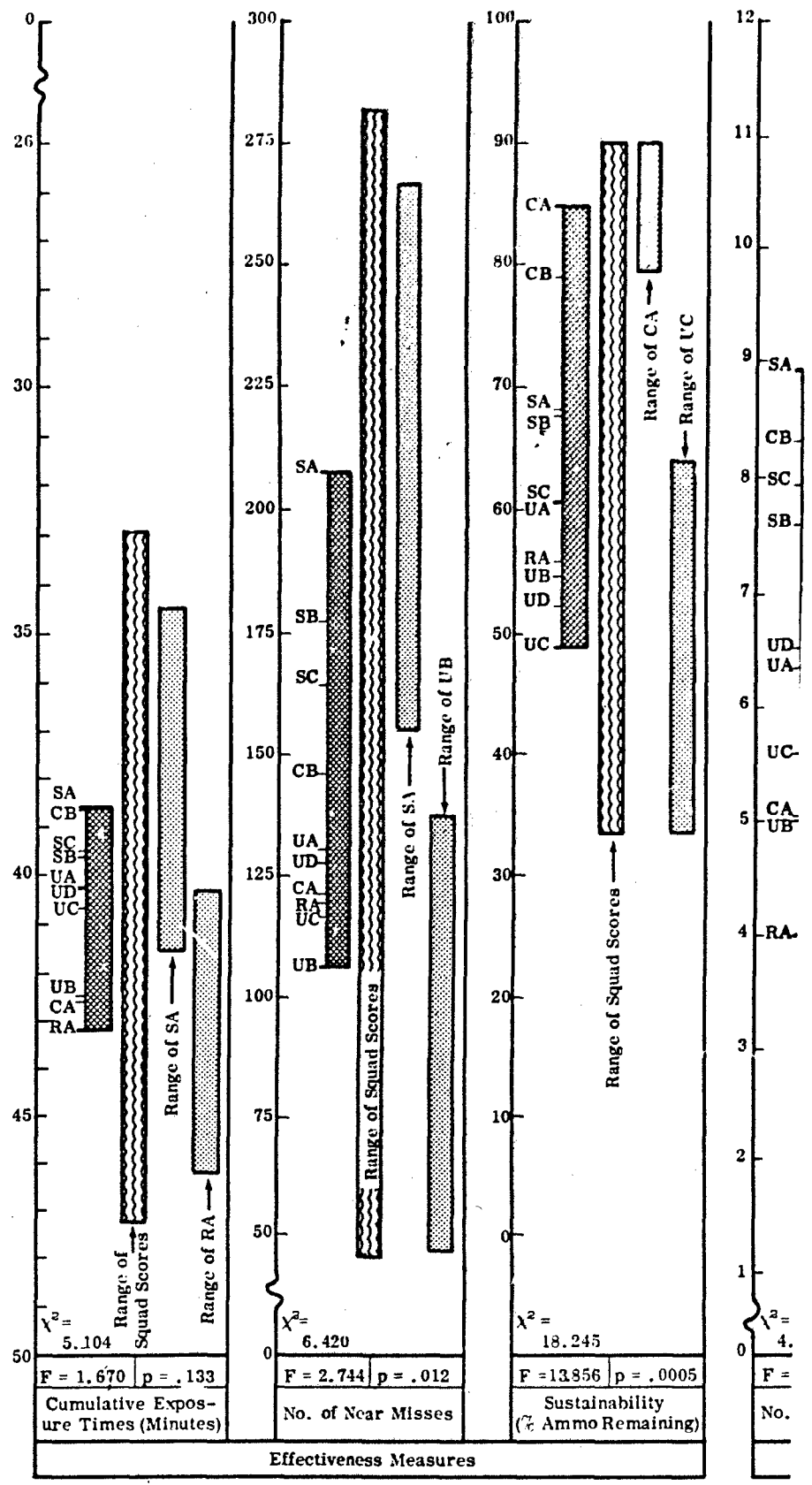

$\bar{X}$  - Mean (Average)  
 SD - Standard Deviation  
 CET - Cumulative Exposure Time  
 z' - Standard Score ( $\bar{X} = 50$ ,  $SD = 20$ )

Figure 6-11 SUMMARY OF RESULTS--S

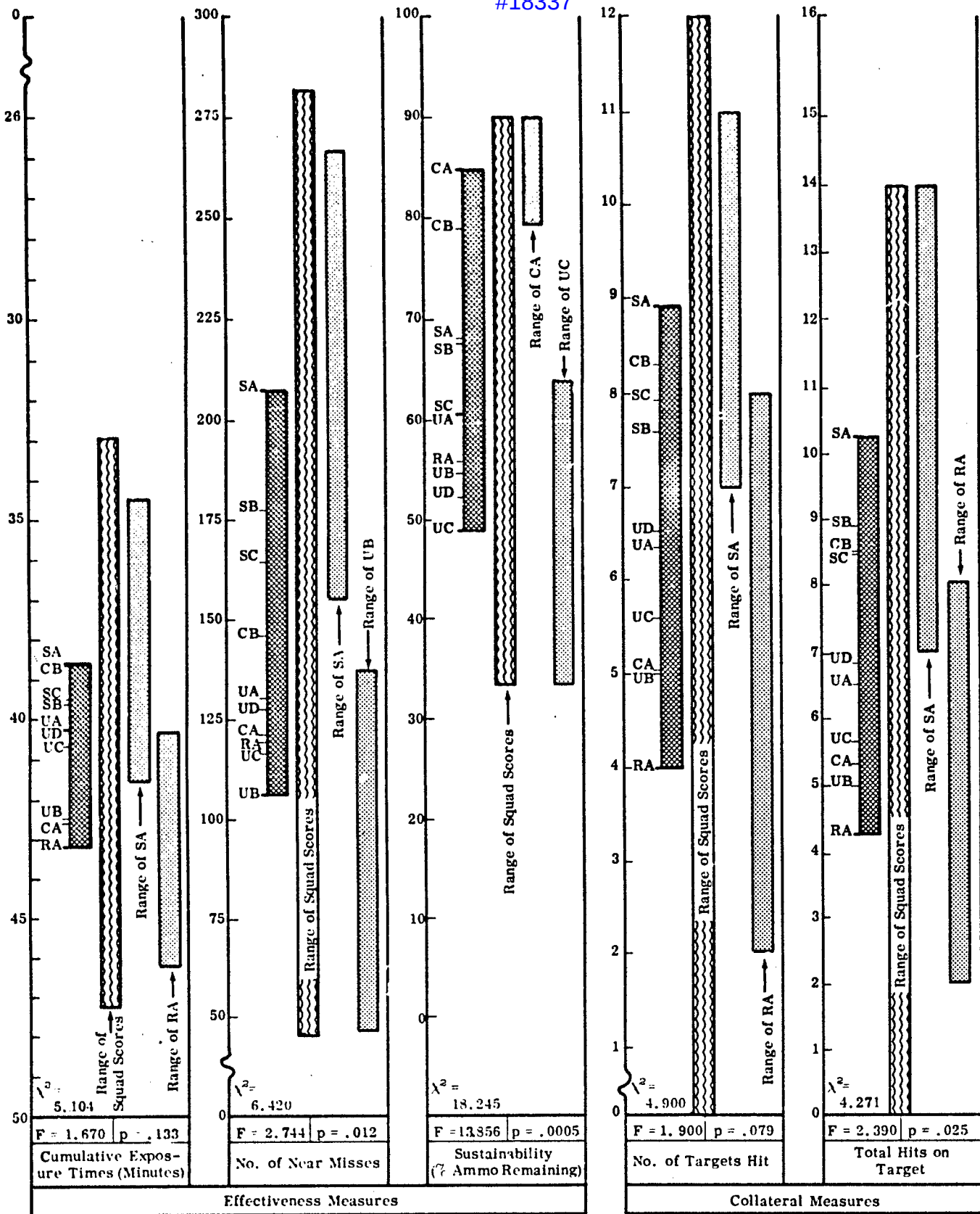

Figure 6-11 SUMMARY OF RESULTS--SITUATION 5

**BLANK PAGE**

EFFECTIVENESS MEASURES

COLLATERAL PERFORMANCE

Cumulative Exposure Times

Mix	$\bar{X}$ CET	SD	Standard Score $z'$
CB	18.6	1.9	76.9
SA	18.6	1.7	72.1
SB	19.2	1.9	65.6
UA	19.4	2.0	59.8
UD	19.8	2.0	52.2
SC	19.9	2.5	50.5
UC	20.2	2.4	44.3
UB	20.7	1.4	34.6
CA	20.8	1.8	31.8
RA	21.8	1.3	12.7
$\bar{X}$	19.93		
$\sigma$	.993		

Number of Near Misses

Mix	$\bar{X}$ Near Misses	SD	Standard Score $z'$
SA	125.7	48.5	82.4
SB	120.3	48.8	77.2
CB	109.0	25.2	66.3
SC	100.5	43.0	58.1
UA	89.9	38.9	47.9
CA	83.3	35.1	41.5
UD	80.0	29.1	38.3
RA	72.2	27.6	30.8
UC	70.3	26.4	29.0
UB	70.0	22.8	28.7
$\bar{X}$	92.13		
$\sigma$	20.73		

Sustainability (Ammo Remaining)

Mix	$\bar{X}$ Ammo Remaining	SD	Standard Score $z'$
CA	85.9	3.8	87.4
CB	80.6	5.8	77.0
SA	71.1	5.1	59.6
SB	70.6	7.0	57.5
SC	65.3	12.0	47.2
UA	63.7	7.5	44.1
RA	59.0	7.4	35.0
UD	57.8	2.7	30.8
UB	57.5	4.5	32.1
UC	55.7	6.2	28.6
$\bar{X}$	66.71		
$\sigma$	10.28		

Number of Targets Hit

Mix	$\bar{X}$ Targets Hit	SD	Standard Score $z'$
CB	5.3	2.1	79.0
SB	5.0	0.9	75.1
SA	4.6	1.0	64.7
SC	4.4	1.8	62.0
UA	4.1	2.1	54.9
UD	3.6	1.9	46.3
CA	3.2	2.2	38.4
UB	3.0	1.5	33.9
UC	2.8	2.0	30.0
RA	2.2	1.6	18.2
$\bar{X}$	3.82		
$\sigma$	1.016		

Target Effects

Mix	Standard Score Target Effects
SA	77.3
CB	71.6
SB	71.4
SC	54.3
UA	53.9
UD	45.3
UC	36.7
CA	36.7
UB	31.7
RA	21.7

Overall Effectiveness

Mix	Overall Fire Effectiveness
CB	73.4
SA	71.0
SB	66.8
CA	53.6
SC	51.9
UA	50.6
UD	41.0
UC	34.0
UB	31.8
RA	26.2

Cumulative Exposure Time

	CB	SA	SB	UA	UD	SC	UC	UB	CA	RA
CB	>.40	.31	.28	.26	.11	.11	.03	.03	.006	
SA		.38	.33	.19	.14	.14	.03	.04	.003	
SB			>.40	.29	.23	.21	.07	.08	.02	
UA				>.40	.37	.31	.18	.17	.06	
UD					>.40	.39	.20	.19	.05	
SC						>.40	.18	.18	.03	
UC							.34	.31	.11	
UB								>.40	.10	
CA									.17	

Number of Near

	SA	SB	CB	SC	UA	CA
SA	>.40	.24	.18	.10	.06	
SB		.29	.21	.11	.07	
CB			.34	.17	.05	
SC				.33	.23	
UA					.38	
CA						
UD						
RA						
UC						

Sustainability (Ammo Remaining)

	CA	CB	SA	SB	SC	UA	RA	UD	UB	UC
CA		.05	.000	.000	.002	.000	.001	.000	.000	.000
CB			.008	.01	.01	.001	.001	.000	.000	.000
SA				>.40	.15	.04	.006	.000	.000	.000
SB					.19	.07	.02	.002	.003	.003
SC						>.40	.17	.08	.09	.06
UA							.16	.05	.06	.04
RA								.36	.35	.23
UD									>.40	.24
UB										.29

No. of Targets Hit

	CB	SB	SA	SC	UA	UD	CA	UB	UC	RA
CB		.38	.23	.23	.16	.09	.06	.03	.03	.02
SB			.23	.26	.17	.08	.05	.01	.02	.004
SA				>.40	.30	.16	.10	.03	.04	.01
SC					.38	.24	.16	.09	.09	.03
UA						.36	.26	.17	.15	.07
UD							.37	.27	.24	.11
CA								>.40	.37	.20
UB									>.40	.21
UC										.30

Total Hits on T

	SB	CB	SA	SC	UA	UD
SB		>.40	.32	.24	.09	.06
CB			.37	.29	.14	.11
SA				.39	.19	.15
SC					.28	.23
UA						>.40
UD						
CA						
UB						
UC						

Note: Standard Scores computed from raw scores using scores to three decimal places.

UA - 9 M14 Rifles  
 UB - 7 M14 Rifles/2 M14E2 AR  
 UC - 5 M14 Rifles/2 M60 MG  
 UD - 9 M14E2 Rifles  
 CA - 9 Colt Rifles

CB - 7 Colt Rifles/2 Colt AR  
 SA - 9 Stoner Rifles  
 SB - 7 Stoner Rifles/2 Stoner AR  
 SC - 7 Stoner Rifles/2 Stoner MG  
 RA - 9 AK47 Rifles

$\bar{X}$  - Mean (Average)  
 SD - Standard Deviation  
 CET - Cumulative Exposure Time  
 $z'$  - Standard Score



COLLATERAL PERFORMANCE MEASURES

Number of Targets Hit				Total Hits on Targets			
Mix	$\bar{X}$ Targets Hit	SD	Standard Score z'	Mix	$\bar{X}$ Hits	SD	Standard Score z'
CB	5.3	2.1	79.0	SB	5.5	1.4	75.9
SB	5.0	0.9	73.1	CB	5.5	2.2	75.4
3A	4.8	1.0	64.7	SA	5.1	1.7	68.6
3C	4.4	1.8	62.0	SC	4.8	2.0	63.5
JA	4.1	2.1	54.9	UA	4.1	2.1	48.9
JD	3.6	1.9	46.3	UD	3.8	2.3	47.1
CA	3.2	2.2	38.4	CA	3.2	2.5	37.4
JB	3.0	1.5	33.9	UB	3.0	1.5	33.5
JC	2.8	2.0	30.0	UC	2.8	2.0	30.1
JA	2.2	1.6	18.2	RA	2.2	1.6	20.0
$\bar{X}$	3.82			$\bar{X}$	3.99		
$\sigma$	1.016			$\sigma$	1.18		

Number of Near Misses

	SA	SB	CB	SC	UA	CA	UD	RA	UC	UB
A	>.40	.24	.18	.10	.06	.04	.03	.02	.02	
B		.29	.21	.11	.07	.04	.03	.02	.02	
B			.34	.17	.09	.05	.02	.02	.01	
C				.33	.23	.18	.12	.09	.08	
A					.38	.32	.21	.17	.15	
A						>.40	.29	.24	.23	
D							.33	.28	.26	
A								>.40	>.40	
C										>.40

Total Hits on Targets

	SB	CB	SA	SC	UA	UD	CA	UB	UC	RA
3	>.40	.32	.24	.09	.08	.04	.009	.01	.004	
B		.37	.29	.14	.11	.07	.02	.03	.01	
1			.39	.19	.15	.09	.03	.03	.01	
1				.28	.23	.14	.06	.06	.02	
1					>.40	.27	.17	.15	.07	
3						.35	.25	.22	.11	
1							>.40	.38	.23	
3								>.40	.21	
1										.30

MR  $\bar{X}$  - Mean (Average)  
 SD - Standard Deviation  
 CET - Cumulative Exposure Time  
 z' - Standard Score ( $\bar{X} = 50, SD = 20$ )

6-53

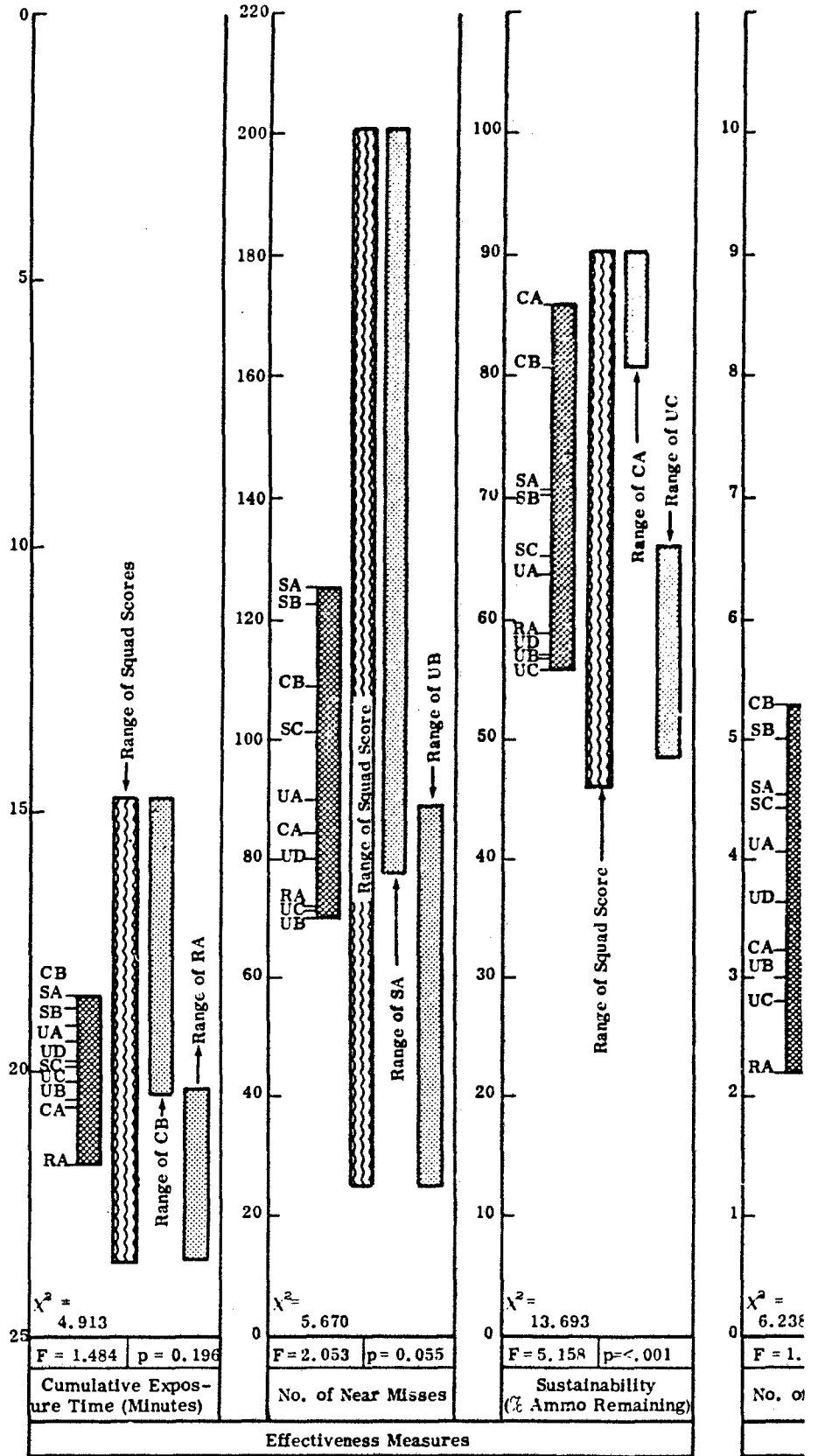

Figure 6-12 SUMMARY OF RESULTS--SITUATION

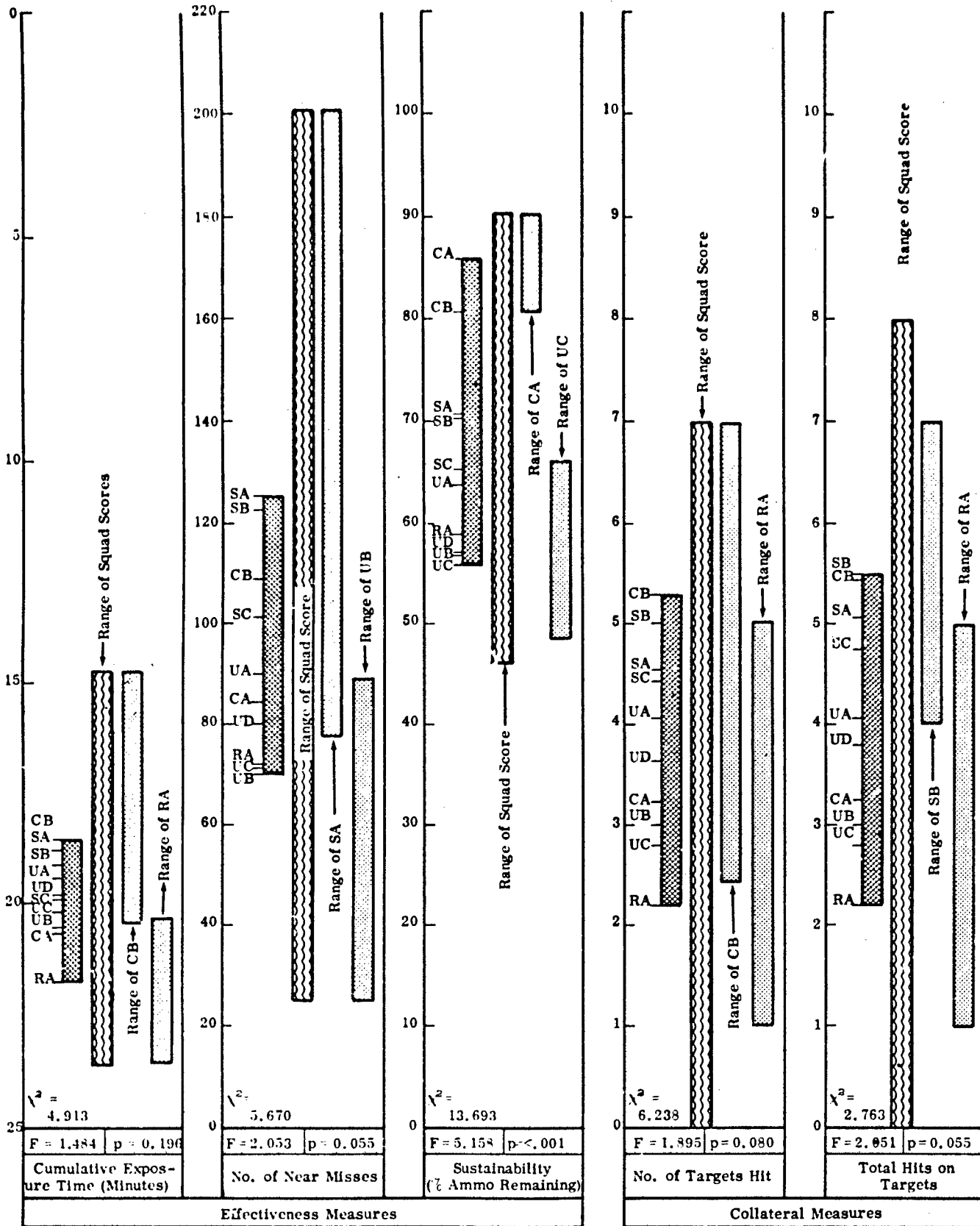

Figure 6-12 SUMMARY OF RESULTS--SITUATION 5 (ARRAY X)

**BLANK PAGE**



EFFECTIVENESS MEASURES

COLLATERAL PE

A Cumulative Exposure Times				B Number of Near Misses				C Sustainability (# Ammo Remaining)				
Mix	$\bar{X}$ CET	SD	Standard Score $z'$	Mix	$\bar{X}$ Near Misses	SD	Standard Score $z'$	Mix	$\bar{X}$ Remaining	SD	Standard Score $z'$	Sustainability Time (Min)
SC	19.7	1.7	75.1	SA	81.7	11.2	94.7	CA	83.7	4.0	86.5	24.5
SA	19.8	2.1	72.5	SC	63.7	23.0	69.8	CB	77.5	4.3	77.1	17.9
CB	20.0	1.8	65.8	SB	57.5	27.8	61.3	SA	65.0	13.9	58.1	11.4
UA	20.4	2.0	57.0	UC	46.8	21.1	46.5	SB	64.6	9.3	57.5	11.3
UC	20.5	2.2	53.4	RA	46.8	20.9	46.4	UA	56.9	6.4	45.8	9.3
SB	20.5	2.9	53.1	UD	45.5	23.8	44.6	SC	55.5	13.8	43.8	9.0
UD	20.5	2.9	53.1	UA	40.5	16.1	37.7	RA	52.7	12.9	39.5	8.5
RA	21.4	1.5	30.6	CA	38.2	20.7	34.5	UB	52.1	5.3	38.5	8.4
UB	21.8	1.3	20.3	CB	36.8	18.4	32.6	UD	46.4	5.2	30.0	7.5
CA	21.8	1.8	20.3	UB	36.2	17.2	31.7	UC	42.0	14.9	23.2	6.9
$\bar{X}$	20.64			$\bar{X}$	49.36			$\bar{X}$	59.63			
$\sigma$	0.77			$\sigma$	14.44			$\sigma$	13.19			

D Number of Targets Hit			
Mix	$\bar{X}$ Targets Hit	SD	Standard Score $z'$
SA	4.3	1.4	91.3
SC	3.5	1.2	69.8
CB	3.0	1.8	56.9
UD	2.9	1.0	54.3
UC	2.8	1.7	52.5
SB	2.7	2.0	48.4
UA	2.3	1.5	38.8
UB	2.0	1.4	31.0
CA	2.0	2.0	31.0
RA	1.8	0.8	25.9
$\bar{X}$	2.73		
$\sigma$	0.77		

F Target Effects		G Overall Effectiveness	
Mix	Standard Score Target Effects	Mix	Overall Fire Effectiveness
SA	83.6	SA	75.1
SC	72.5	SC	62.9
SB	57.2	CB	58.5
UC	50.0	SB	57.3
CB	49.2	CA	47.1
UD	48.9	UA	46.8
UA	47.4	UD	42.6
RA	38.5	UC	41.0
CA	27.4	RA	38.8
UB	26.0	UB	30.2

H Cumulative Exposure Time										I Number of Targets Hit				
	SC	SA	CB	UA	UC	SB	UD	RA	UB	CA	SA	SC	SB	UC
SC		>.40	.34	.27	.22	.25	.13	.05	.02	.03		.06	.04	.004
SA			>.40	.33	.28	.31	.22	.09	.04	.05			.34	.11
CB				.39	.35	.37	.28	.11	.04	.06				.24
UA					>.40	>.40	>.40	.22	.12	.14				
UC						>.40	>.40	.29	.13	.15				
SB							>.40	.28	.17	.19				
UD								.13	.04	.08				
RA									.32	.25				
UB										>.40				

J Sustainability (# Ammo Remaining)										
	CA	CB	SA	SB	UA	SC	RA	UB	UD	UC
CA		.02	.005	.000	.000	.000	.001	.000	.000	.000
CB			.03	.007	.000	.003	.001	.000	.000	.000
SA				>.40	.11	.03	.69	.03	.007	.61
SB					.07	.11	.06	.01	.002	.006
UA						>.40	.25	.10	.006	.03
SC							.37	.29	.08	.07
RA								>.40	.15	.12
UB									.05	.08
UD										.25

K No. of Targets Hit										L Total				
	SA	SC	CB	UD	UC	SB	UA	UB	CA	RA	SA	SC	SB	CB
SA		.15	.09	.04	.07	.06	.02	.01	.02	.004		.08	.10	.04
SC			.29	.19	.23	.20	.09	.04	.08	.02			>.40	.25
CB				>.40	>.40	.38	.25	.16	.19	.11				>.40
UD					>.40	>.40	.22	.12	.17	.04				
UC						>.40	.29	.19	.23	.13				
SB							.37	.26	.29	.19				
UA								.37	.39	.27				
UB									>.40	>.40				
CA										>.40				

Note: Standard Scores computed from raw scores using scores to three decimal places.

UA - 9 M14 Rifles  
 UB - 7 M14 Rifles/2 M14E2 AR  
 UC - 5 M14 Rifles/2 M60 MG  
 UD - 9 M14E2 Rifles  
 CA - 9 Colt Rifles

CB - 7 Colt Rifles/2 Colt AR  
 SA - 9 Stoner Rifles  
 SB - 7 Stoner Rifles/2 Stoner AR  
 SC - 7 Stoner Rifles/2 Stoner MG  
 RA - 9 AK47 Rifles

$\bar{X}$  - M  
 SD - St  
 CET - Ct  
 $z'$  - St

COLLATERAL PERFORMANCE MEASURES

Number of Targets Hit				Total Hits on Targets					
D	Mix	X Targets Hit	SD	Standard Score Z'	E	Mix	Z Hits	SD	Standard Score Z'
SC	3.5	1.2	69.8	SC	3.7	1.4	65.2		
CB	3.0	1.8	56.9	SB	3.3	2.7	58.3		
UD	2.9	1.0	54.3	CB	3.0	1.8	51.6		
UC	2.8	1.7	52.5	UD	2.9	1.0	49.6		
SB	2.7	2.0	48.4	UC	2.8	1.7	48.2		
UA	2.3	1.5	38.8	UA	2.3	1.5	37.4		
UB	2.0	1.4	31.0	RA	2.0	0.7	31.3		
CA	2.0	2.0	31.0	UB	2.0	1.4	31.3		
RA	1.8	0.8	25.9	CA	2.0	2.0	31.3		
$\bar{X}$	2.73			$\bar{X}$	2.92				
$\sigma$	0.77			$\sigma$	0.98				

Number of Near Misses

CA	SA	SC	SB	UC	RA	UD	UA	CA	CB	UB
.03 SA		.06	.04	.004	.004	.004	.001	.001	.000	.001
.05 SC			.34	.11	.12	.11	.04	.04	.02	.02
.06 SB				.24	.25	.22	.11	.10	.08	.07
.14 UC					>.40	>.40	.29	.24	.20	.18
.15 RA						>.40	.29	.26	.21	.19
.19 UD							.34	.29	.25	.23
.08 UA								>.40	.36	.33
.25 CA									>.40	>.40
.40 CB										>.40

Total Hits on Targets

RA	SA	SC	SB	CB	UD	UC	UA	RA	UB	CA
004 SA		.08	.10	.04	.02	.03	.01	.004	.005	.01
02 SC			>.40	.25	.15	.19	.07	.02	.03	.06
11 SB				>.40	.36	.36	.22	.15	.15	.18
04 CB					>.40	>.40	.25	.14	.16	.19
13 UD						>.40	.22	.07	.12	.17
19 UC							.29	.17	.19	.23
27 UA								.35	.37	.39
40 RA									>.40	>.40
40 UB										>.40

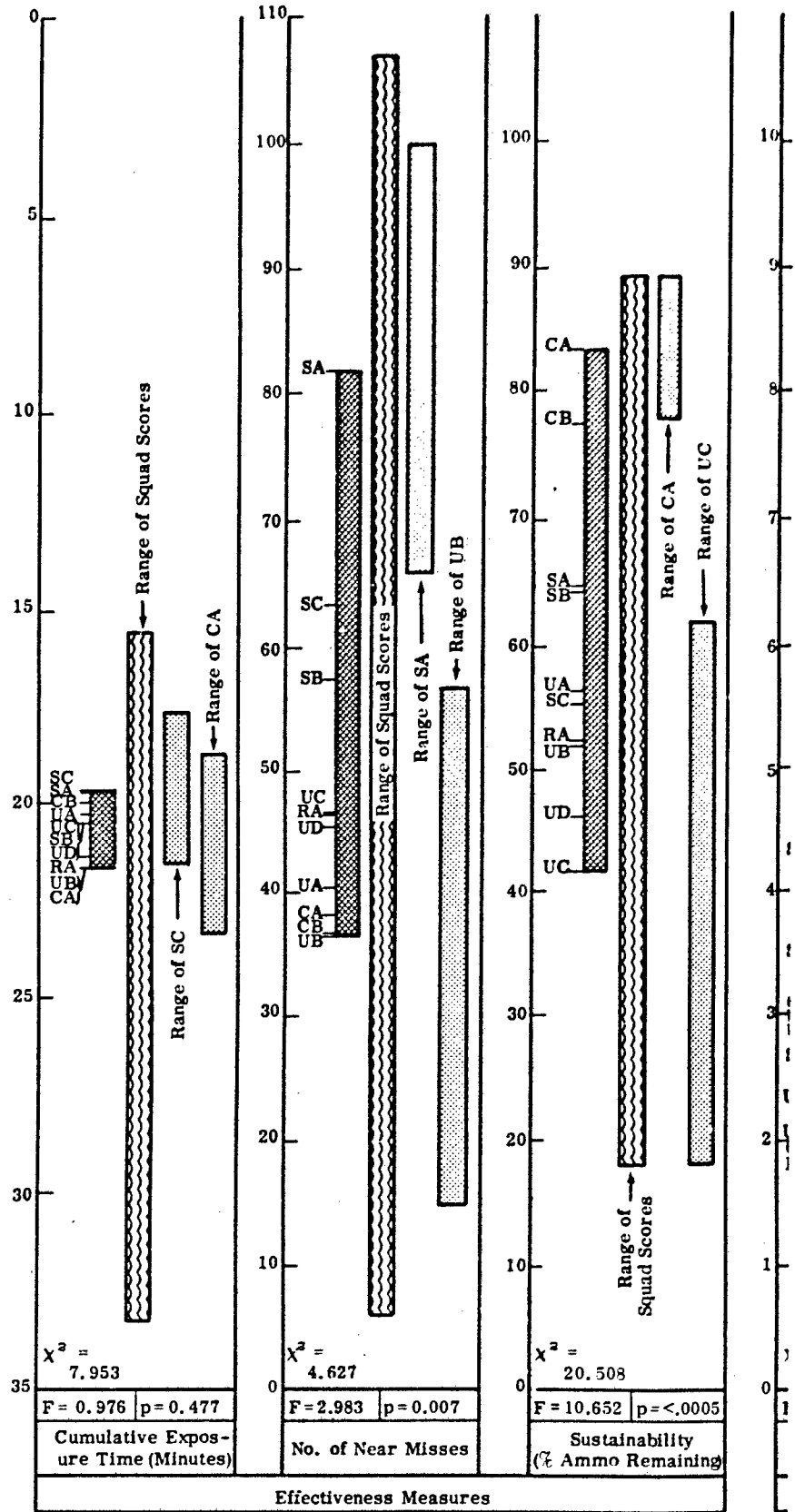

2 Colt AR  
 s  
 s/2 Stoner AR  
 s/2 Stoner MG

$\bar{X}$  - Mean (Average)  
 SD - Standard Deviation  
 CET - Cumulative Exposure Time  
 z' - Standard Score (X = 50, SD = 20)

Figure 6-13 SUMMARY OF RESULTS--SITU

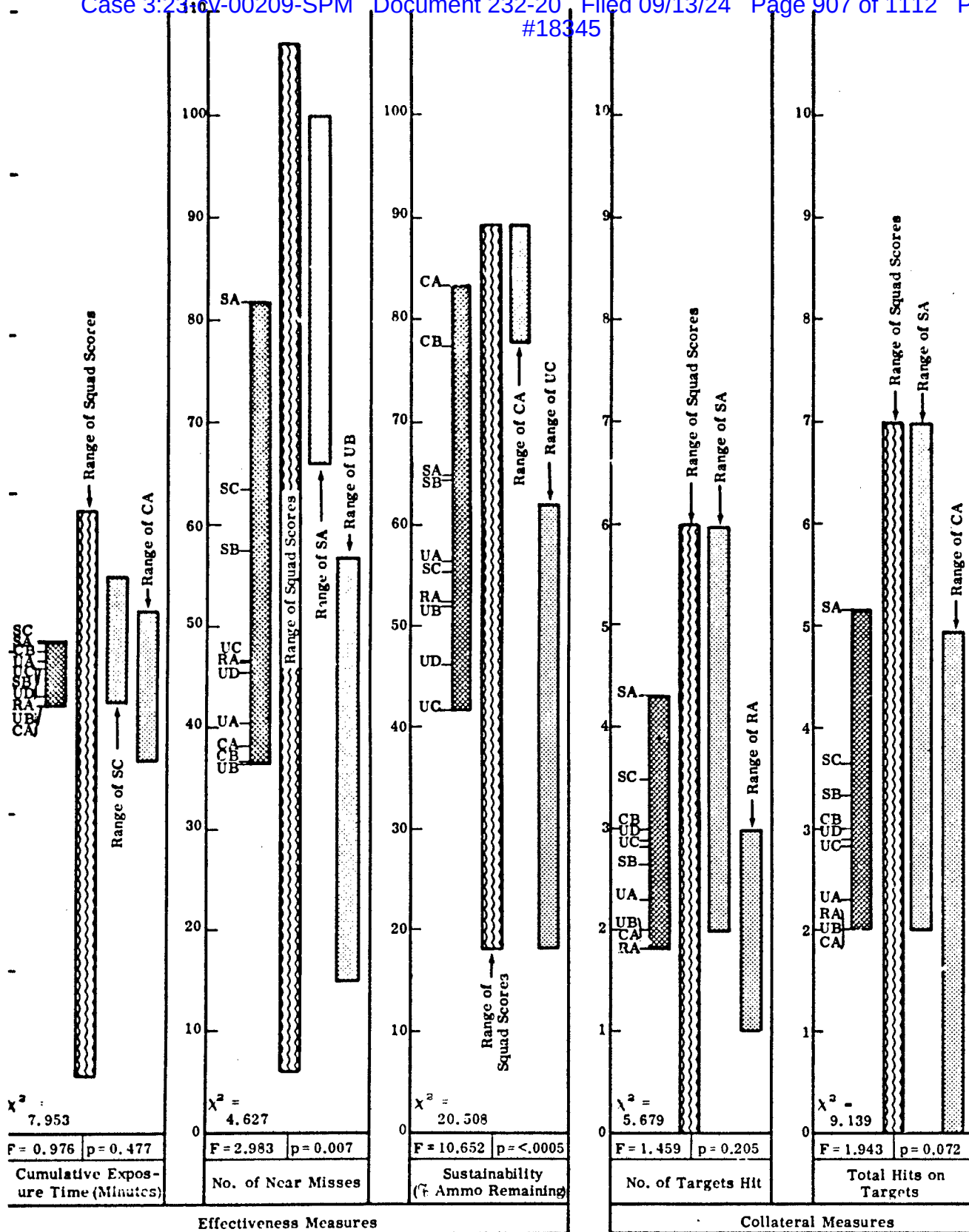

Figure 6-13 SUMMARY OF RESULTS--SITUATION 5 (ARRAY Y)

**BLANK PAGE**

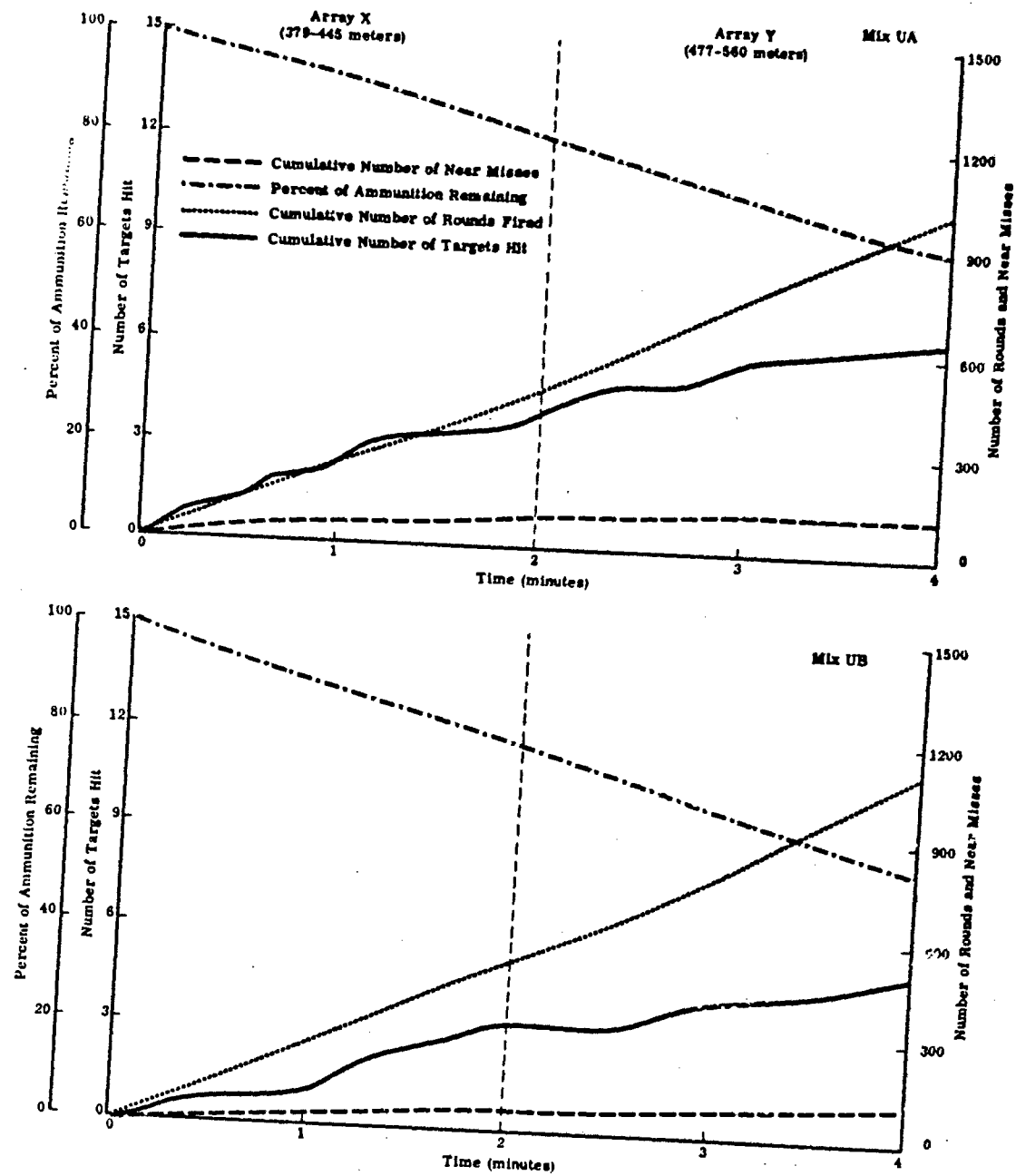

Figure 6-14 CUMULATIVE NUMBER OF ROUNDS FIRED, TARGETS HIT, NEAR MISSES, AND PERCENT OF AMMUNITION REMAINING--SITUATION 5

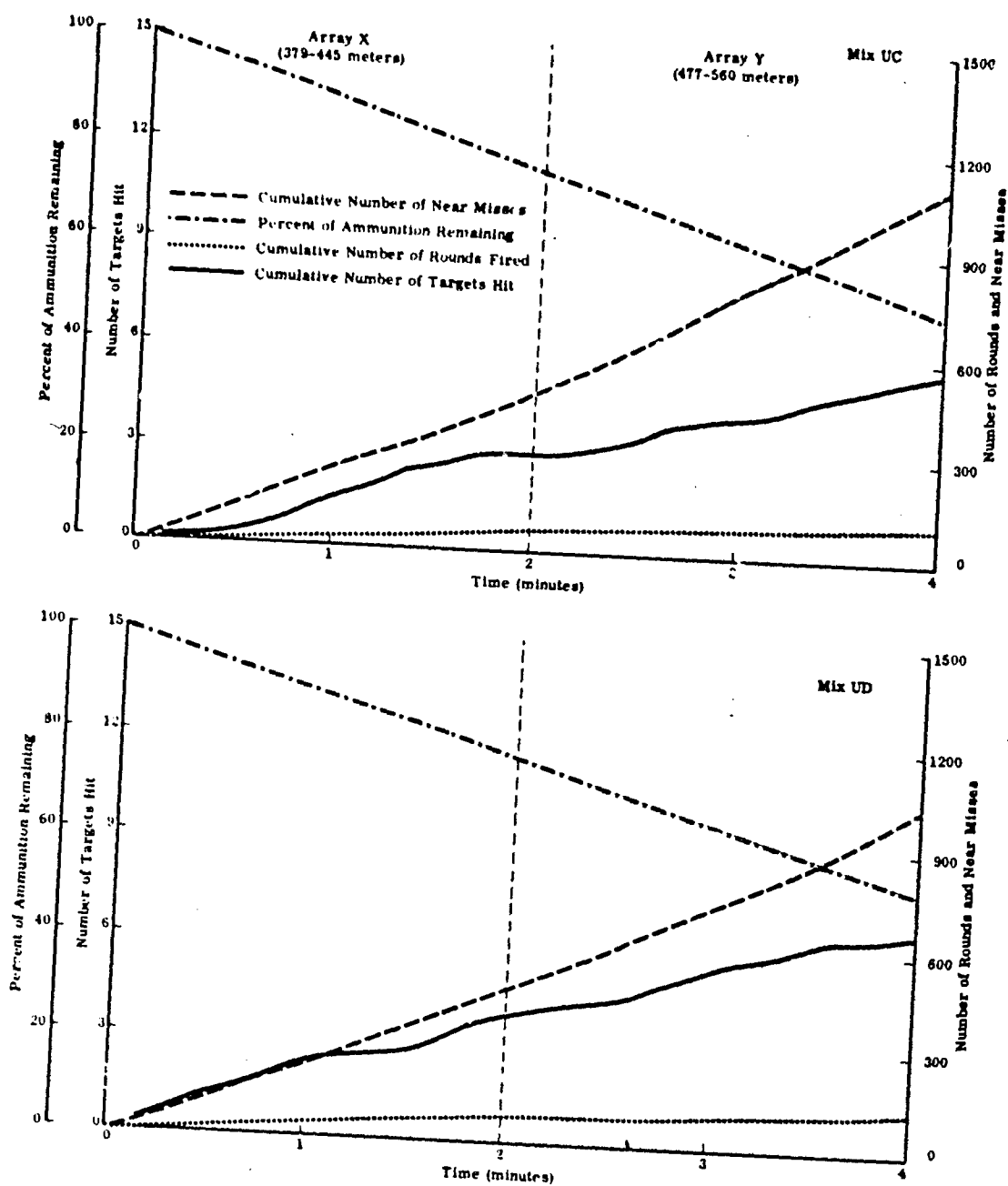

Figure 6-14 (Continued)  
 CUMULATIVE NUMBER OF ROUNDS FIRED, TARGETS HIT, NEAR MISSES,  
 AND PERCENT OF AMMUNITION REMAINING--SITUATION 5

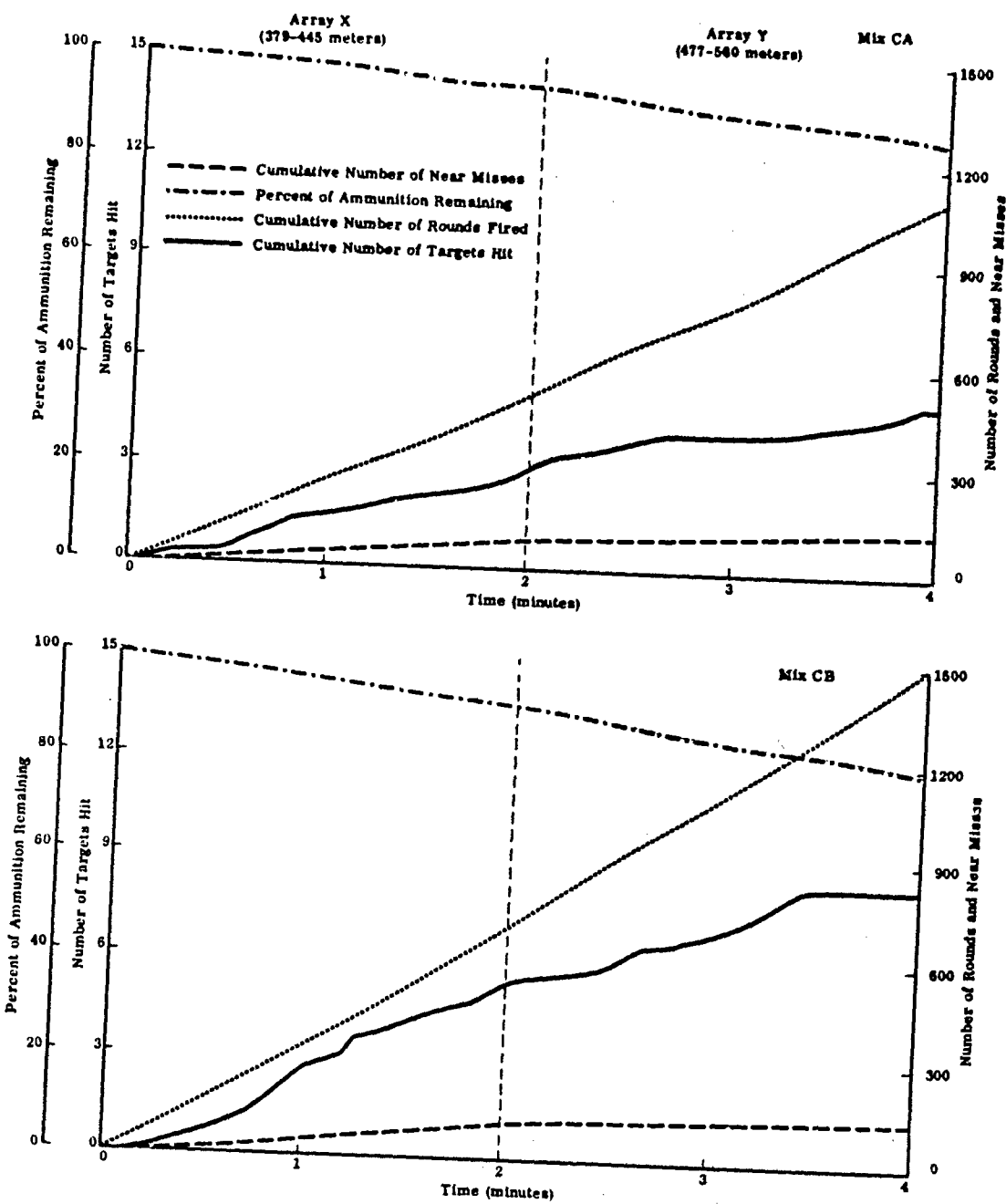

Figure 6-14 (Continued)  
 CUMULATIVE NUMBER OF ROUNDS FIRED, TARGETS HIT, NEAR MISSES,  
 AND PERCENT OF AMMUNITION REMAINING--SITUATION 5

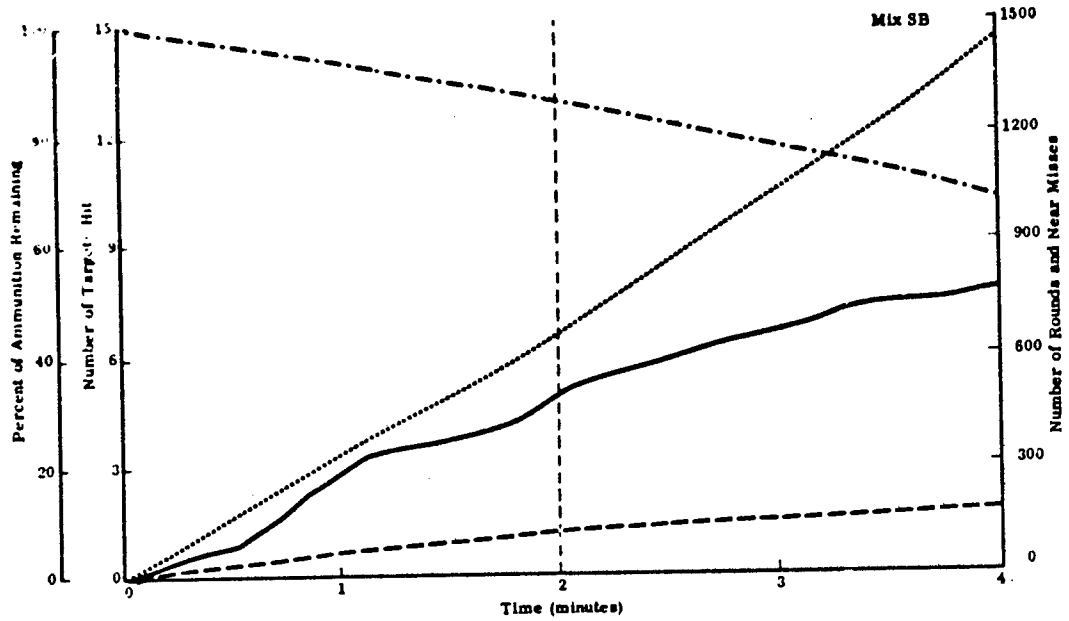
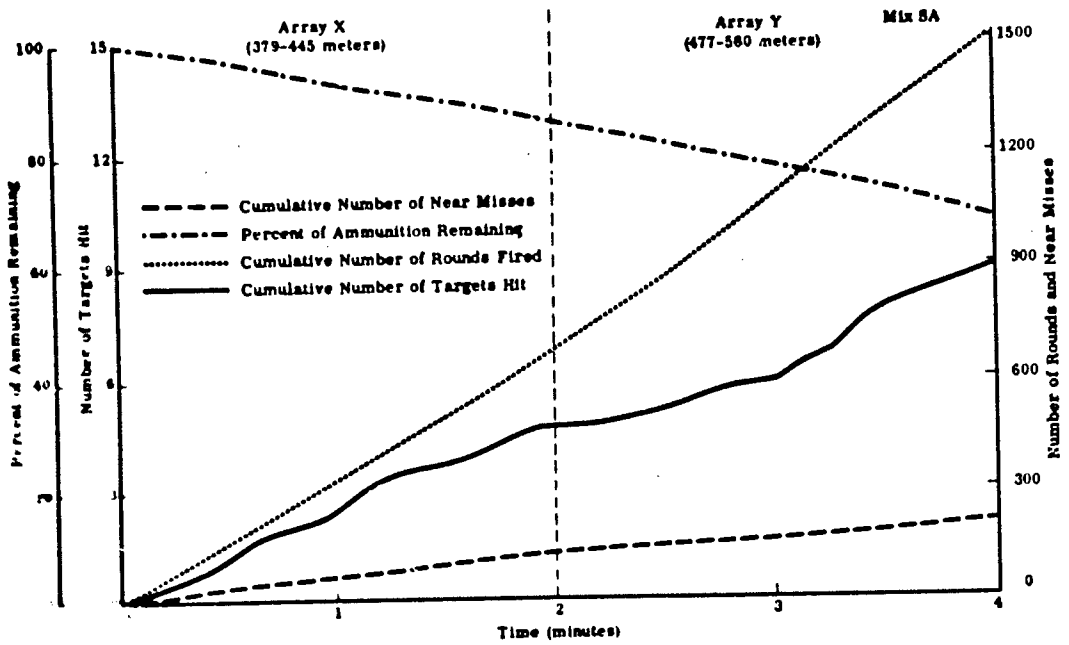

Figure 6-14 (Continued)

CUMULATIVE NUMBER OF ROUNDS FIRED, TARGETS HIT, NEAR MISSES, AND PERCENT OF AMMUNITION REMAINING--SITUATION 5



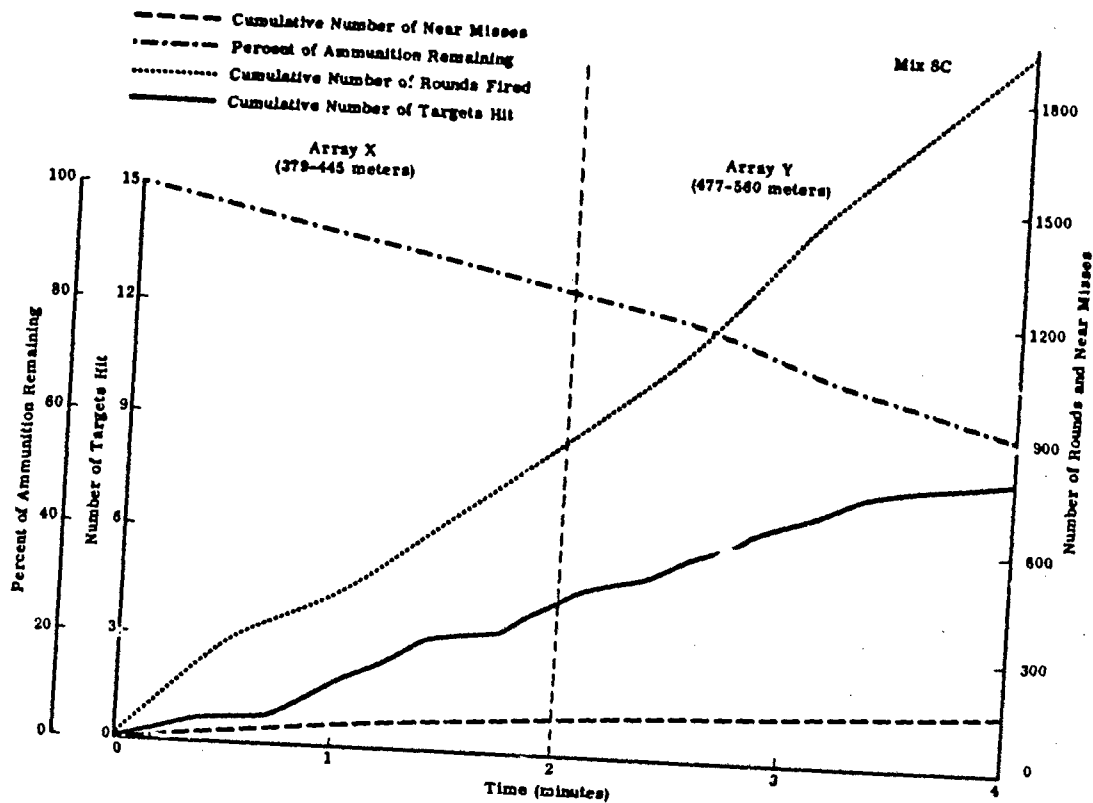

Figure 6-14 (Continued)  
CUMULATIVE NUMBER OF ROUNDS FIRED, TARGETS HIT, NEAR MISSES,  
AND PERCENT OF AMMUNITION REMAINING--SITUATION 5

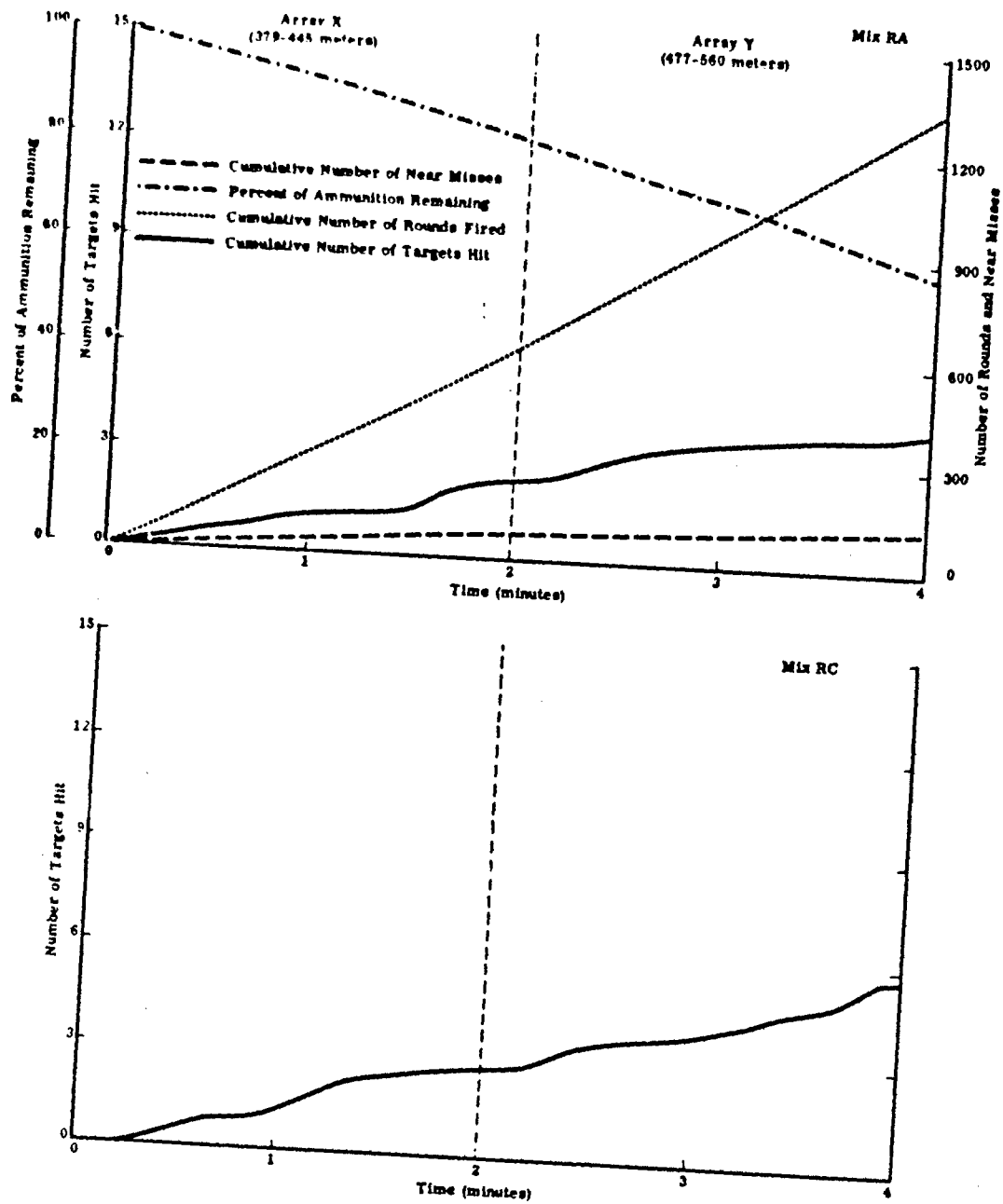

Figure 6-14 (Concluded)  
 CUMULATIVE NUMBER OF ROUNDS FIRED, TARGETS HIT, NEAR MISSES,  
 AND PERCENT OF AMMUNITION REMAINING--SITUATION 5

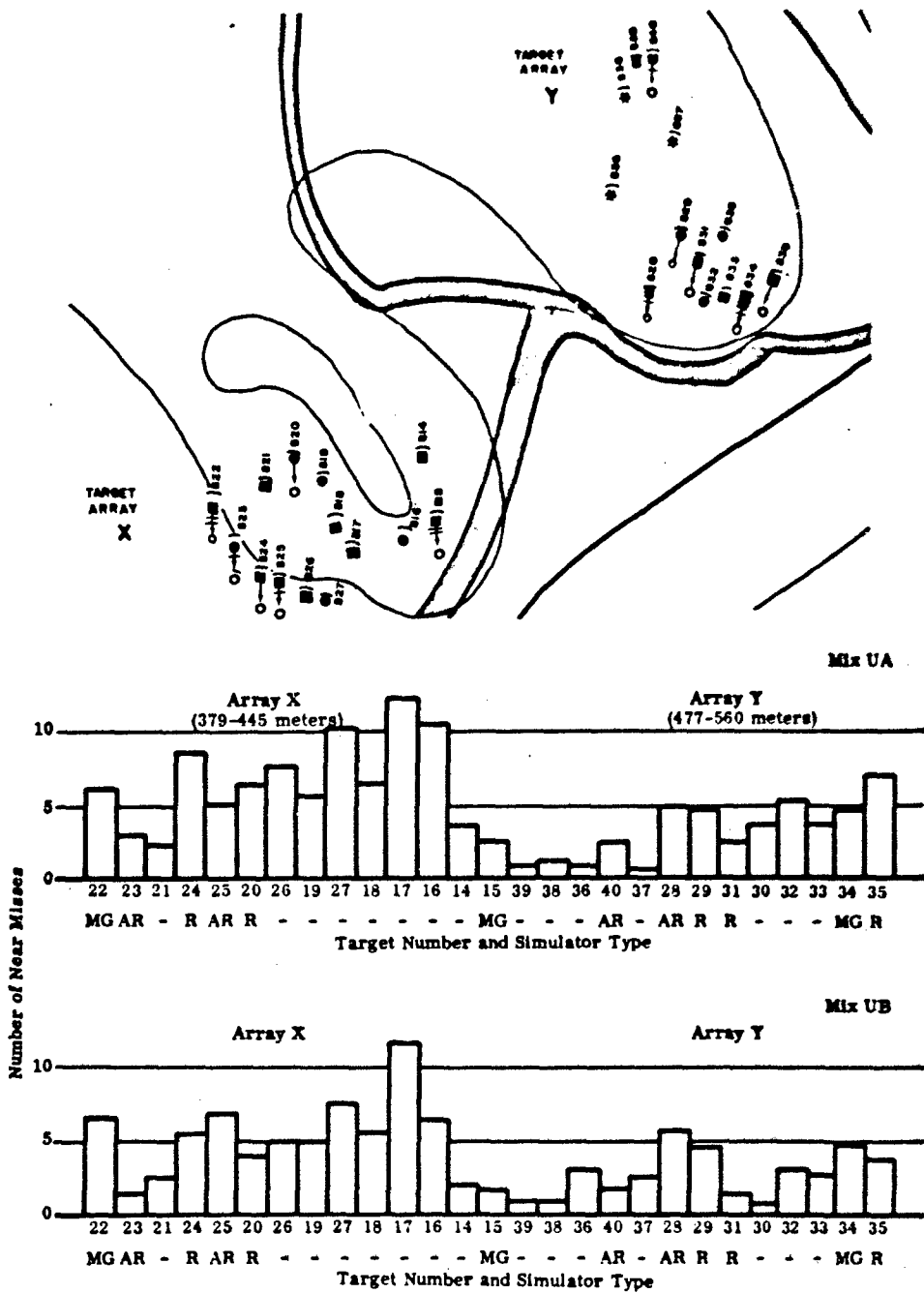

Figure 6-15 NUMBER AND DISTRIBUTION OF NEAR MISSES--SITUATION 5

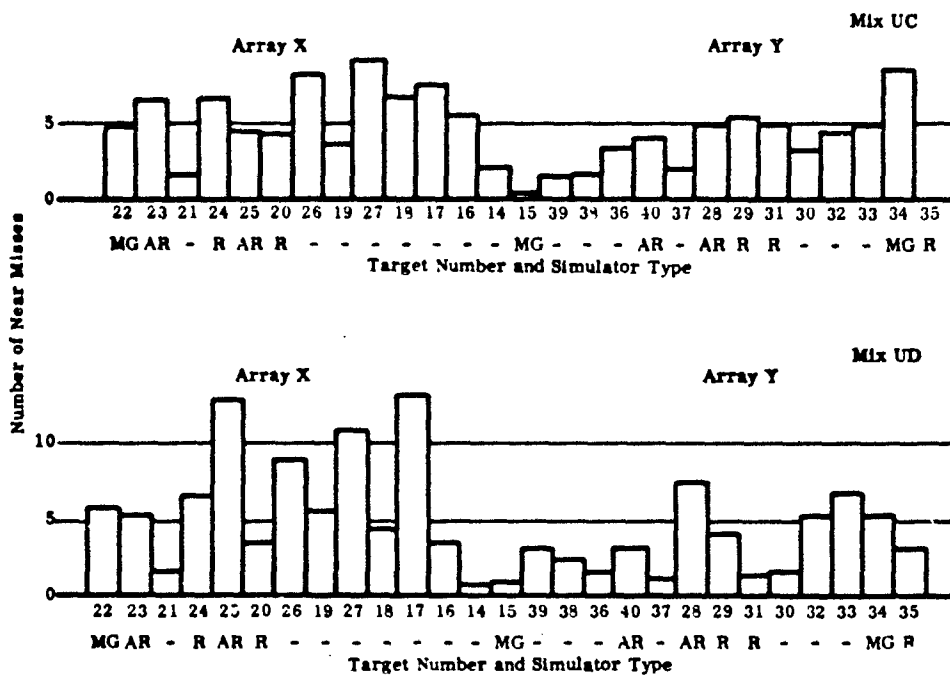
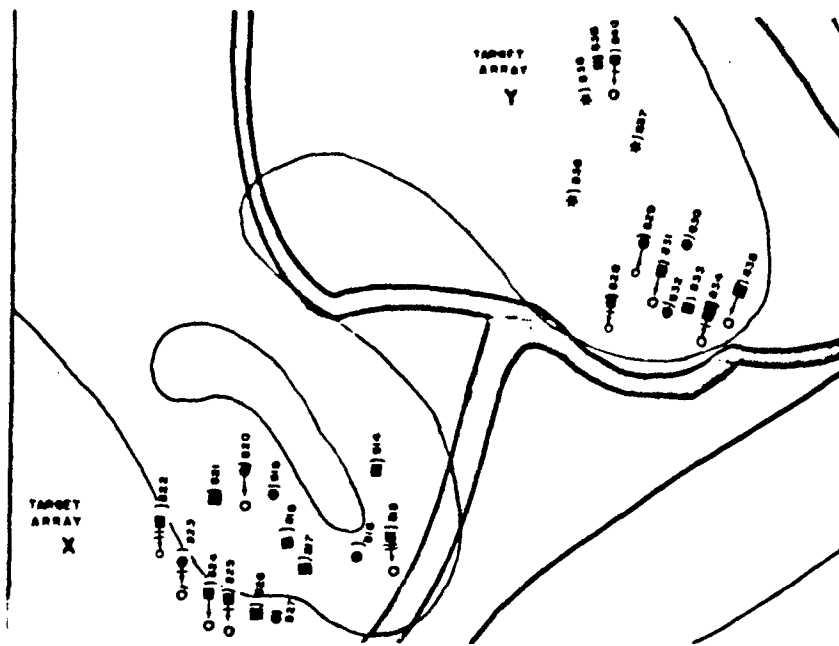

Figure 6-15 (Continued) NUMBER AND DISTRIBUTION OF NEAR MISSES--SITUATION 5

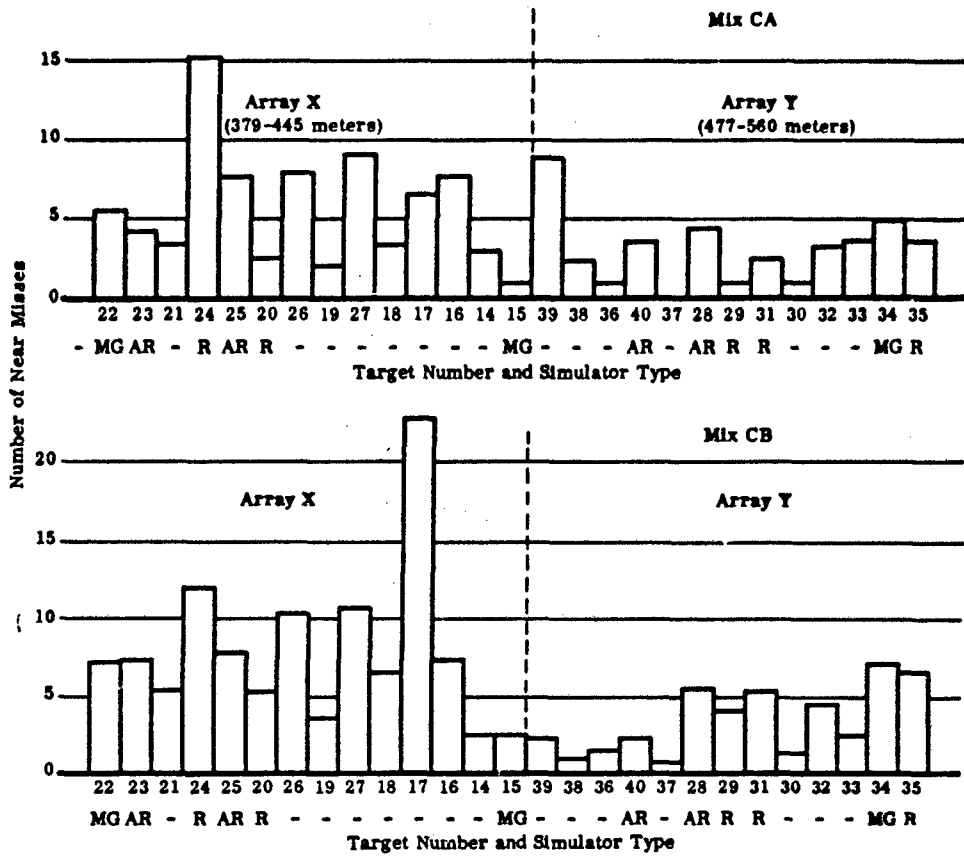

Figure 6-15 (Continued) NUMBER AND DISTRIBUTION OF NEAR MISSES--SITUATION 5

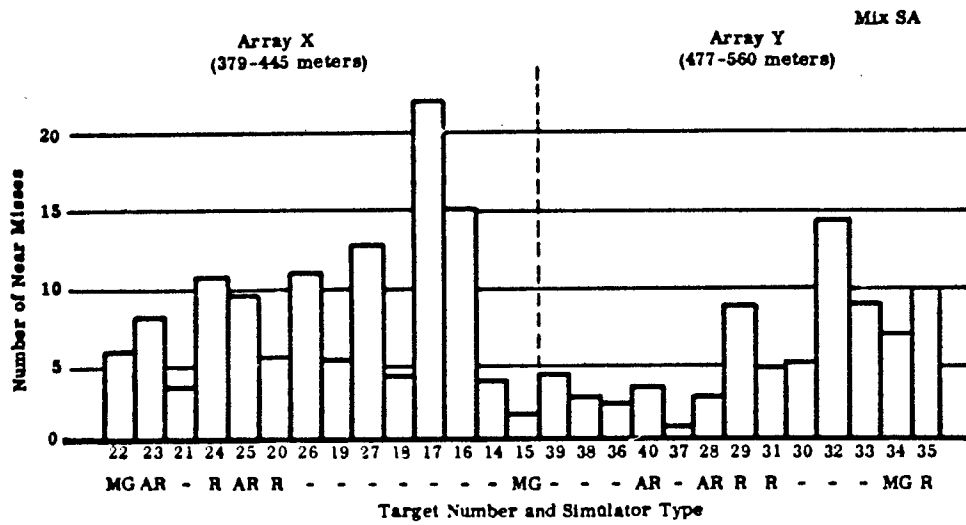

Figure 6-15 (Continued) NUMBER AND DISTRIBUTION OF NEAR MISSES--SITUATION 5

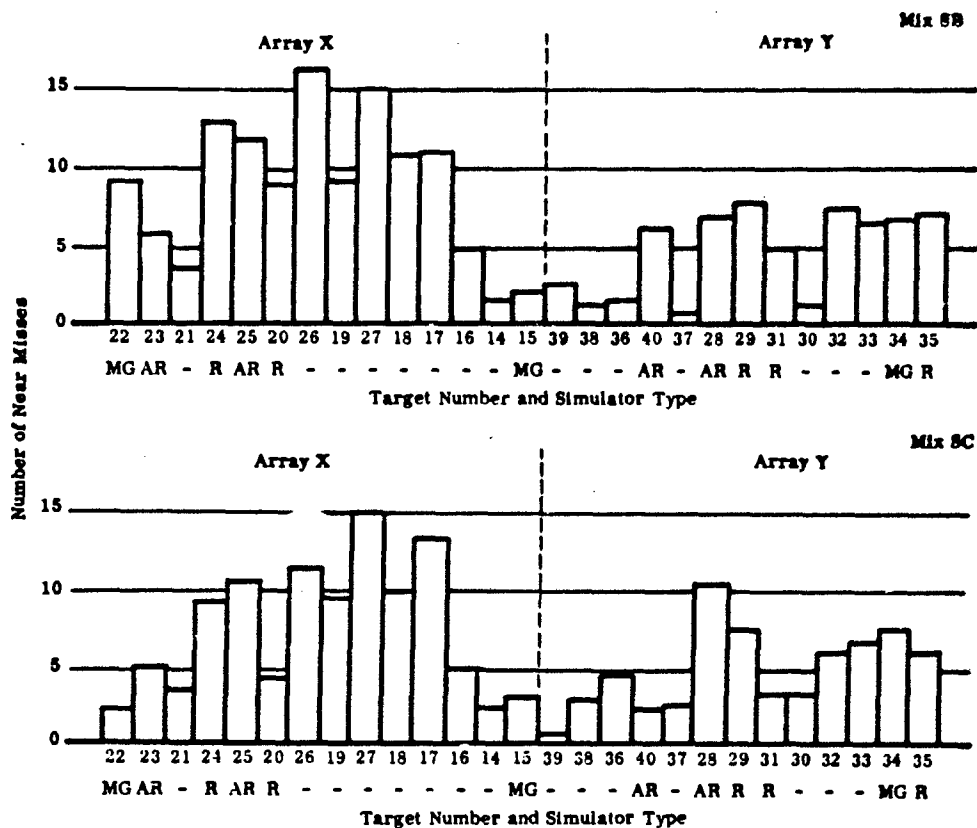

Figure 6-15 (Continued) NUMBER AND DISTRIBUTION OF NEAR MISSES--SITUATION 5

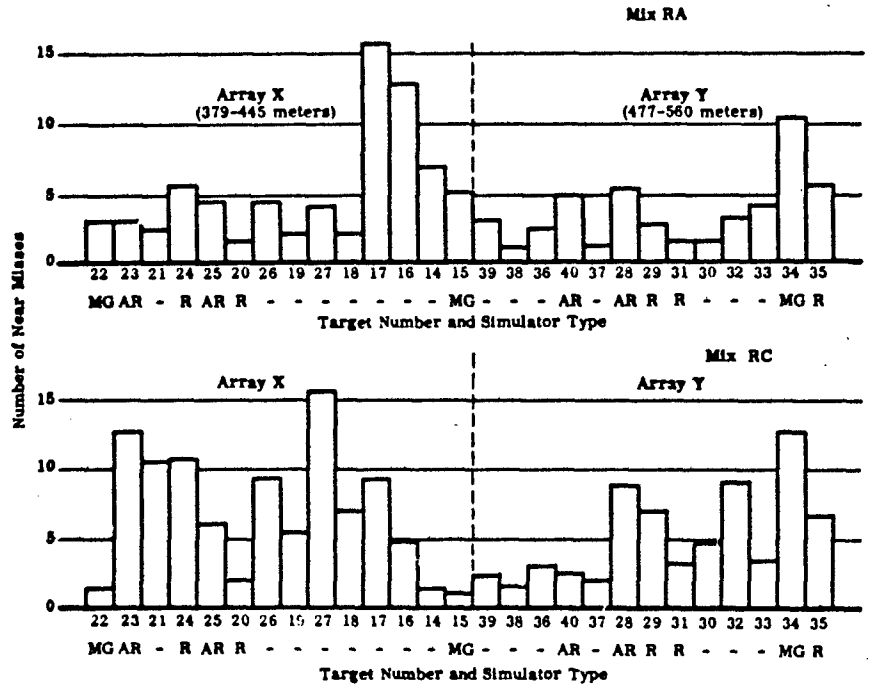
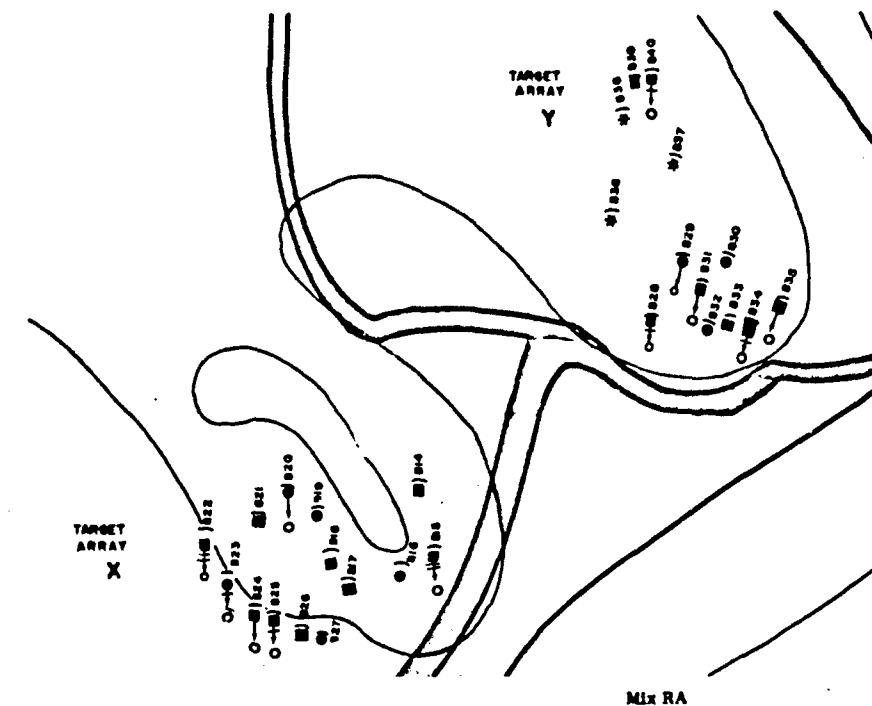

Figure 6-15 (Concluded) NUMBER AND DISTRIBUTION OF NEAR MISSES--SITUATION 5



5. Situation 7: Rifle Squad in Defense Against Attack

Rifle squad weapon mixes fired from hastily prepared foxholes at enemy targets appearing at ranges from 345 meters to 45 meters. Targets appeared in sequence, with long range targets appearing first. The attack ended with ten targets in an assault formation 45 meters from the firing positions. The duration of the situation was 8.19 minutes.

Two series of runs were made in this situation: Series 1, in which M14 rifles, were fired in the semiautomatic mode, while Stoner, Colt, M14E2, and AK47 weapons fired in the automatic mode; and Series 2, in which half of each mix fired automatic and the other half fired semi-automatic. Series 2 determined the best mode of fire (semiautomatic or automatic) for the various rifles and provided an index of the percentage increase or decrease in effectiveness furnished by automatic and semi-automatic fire in this situation (primarily aimed fire as a function of time at visible targets). Weapon mixes were then compared on the basis of their best mode of fire as determined by these Series 2 results. If Series 2 results showed a decrease in effectiveness resulting from a mode of fire different from that used in Series 1, the Series 1 score was left untouched. However, if Series 2 firings showed that a given percentage increase in effectiveness could be expected by using a mode of fire different from that used in Series 1, that mix's Series 1 score was increased (for comparative purposes) by an amount equivalent to the percent of increase indicated by Series 2 results. Results of Series 2 firings indicated that within the squad context in terms of both target effects and overall effectiveness (visible quick exposure targets from 45 to 345 meters), semiautomatic fire was superior to automatic fire for all rifles.

Results for the ten mixes (other than Mix RC) are presented in Figure 6-16. Figure 6-17 presents plots of cumulative exposure time (CET), targets hit, rounds fired, total hits, and percent of ammunition remaining as a function of range for the Colt, Stoner, AK47, and the all-M14E2 squad mixes in automatic fire, and for the other US 7.62mm mixes in semiautomatic fire. Although Figure 6-16 illustrates the expected performance of mixes in their best mode of fire, the plots in Figure 6-17 represent only firings in Series 1; therefore, Figure 6-17 is presented for purposes of illustration and does not necessarily represent performances with the weapons in their best mode of fire.

The rank order of weapon mixes (other than Mix RC) with associated standard scores are given below.

Target Effects Only			Overall Effectiveness*		
Rank	Mix	Standard Score	Rank	Mix	Standard Score
1	CB	86.4	1	CB	84.6
2	SC	65.3	2	SC	61.5
3	SB	63.8	3	SB	60.2
4	CA	59.5	4	CA	59.5
5	UA	55.7	5	SA	57.6
6	SA	48.0	6	UA	55.2
7	RA	37.4	7	RA	37.6
8	UB	33.1	8	UB	33.8
9	UC	31.8	9	UB	31.1
10	UD	19.1	10	UD	19.0

\* Sustainability weighted 1/3/ Target effects 2/3

Key:

- UA - 9 M14 Rifles
- UD - 9 M14E2 Rifles
- UB - 7 M14 Rifles and 2 M14E2 AR
- UC - 5 M14 Rifles and 2 M60 MG
- SA - 9 Stoner Rifles
- SB - 7 Stoner Rifles and 2 Stoner AR
- SC - 7 Stoner Rifles and 2 Stoner MG
- CA - 9 Colt Rifles
- CB - 7 Colt Rifles and 2 Colt AR
- RA - 9 AK47 Rifles

Mix RC results for Situation 7 are presented below.

CET	Near Misses	Percent Ammo Remaining	Targets Hit	Total Hits
6.74	--	61.44	46.60	72.00

EFFECTIVENESS MEASURES

COLLATERAL PERFORMANCE MEASURES

Cumulative Exposure Times				Number of Near Misses				Sustainability (% Ammo Remaining)				
Mix	X (ET)	SD	Standard Score Z'	Mix	X (Near Misses)	SD	Standard Score Z'	Mix	X (Remaining)	SD	Standard Score Z'	Sustainability Time (Min)
CB	4.1	0.9	86.1					CB	94.8	1.0	80.9	158.1
SC	5.0	0.7	64.8					SA	91.4	2.2	76.8	95.6
SB	5.0	1.4	63.8					CA	77.1	5.8	59.8	35.9
CA	5.2	1.2	59.2					UA	72.5	6.7	54.0	29.9
UA	5.4	0.4	55.4					SC	72.4	8.2	53.9	29.8
SA	5.6	0.6	50.3					SB	71.7	7.4	53.1	29.1
RA	6.1	0.9	37.2					UC	55.1	12.5	37.9	20.1
UB	6.3	0.7	32.9					RA	59.1	5.2	37.9	20.1
UC	6.3	0.7	31.7					UB	50.1	12.9	27.1	16.5
UD	6.8	1.5	18.7					UD	43.1	7.5	18.7	14.5
$\bar{X}$	5.57			$\bar{X}$				$\bar{X}$	69.12			
$\sigma$	.79			$\sigma$				$\sigma$	16.64			

Number of Targets Hit				Total Hits on Targets			
Mix	X (Targets Hit)	SD	Standard Score Z'	Mix	X (Hits)	SD	Standard Score Z'
SB	56.0	0.0	77.4	CB	90.5	17.0	84.0
SC	56.0	0.0	77.4	CA	84.5	11.5	69.1
CB	34.4	4.1	69.5	SB	82.5	23.0	64.3
RA	32.8	4.0	61.2	SC	82.2	10.1	63.4
CA	50.2	3.7	49.4	RA	76.7	11.5	49.9
UA	48.5	3.4	37.6	UC	74.2	12.2	13.8
UB	48.1	3.7	37.8	UB	73.4	8.4	41.8
UC	47.5	1.6	34.6	UD	70.2	5.8	33.8
SA	47.0	1.8	32.4	UA	69.2	8.7	31.4
UD	44.9	4.1	21.8	SA	64.1	8.1	18.7
$\bar{X}$	50.54			$\bar{X}$	76.74		
$\sigma$	4.00			$\sigma$	8.10		

Target Effects		Overall Effectiveness	
Mix	Standard Score Target Effects	Mix	Overall Fire Effectiveness
CB	86.1	CB	84.4
SC	64.8	SC	61.2
SB	63.8	SB	60.2
CA	59.2	CA	59.3
UA	55.4	SA	59.1
SA	50.3	UA	54.9
RA	37.2	RA	37.4
UB	32.9	UC	33.8
UC	31.7	UB	31.0
UD	18.7	UD	18.7

Cumulative Exposure Time										
	CB	SC	SB	CA	UA	SA	RA	UB	UC	UD
CB		.05	.11	.06	.006	.004	.004	.000	.000	.003
SC			>.40	.35	.15	.08	.02	.006	.005	.02
SB				>.40	.30	.21	.09	.04	.04	.03
CA					>.40	.27	.11	.05	.04	.04
UA						.25	.05	.01	.01	.02
SA							.13	.04	.03	.05
RA								.36	.33	.19
UB									>.40	.22
UC										.24

Number of Near Misses										
	CB	SC	SB	CA	UA	SA	RA	UB	UC	UD
CB										
SC										
SB										
CA										
UA										
SA										
RA										
UB										
UC										

Sustainability (% Ammo Remaining)										
	CB	SA	CA	UA	SC	SB	UC	RA	UB	UD
CB		.004	.000	.000	.000	.000	.000	.001	.000	.000
SA			.001	.000	.001	.001	.000	.001	.000	.000
CA				.12	.14	.10	.008	.001	.000	.000
UA					>.40	>.40	.03	.004	.003	.000
SC						>.40	.03	.008	.004	.000
SB							.04	.006	.004	.000
UC								>.40	.13	.02
RA									.09	.003
UB										.14
UD										

No. of Targets Hit										
	SB	SC	CB	RA	CA	UA	UB	UC	SA	UD
SB		*	*	*	*	*	*	*	*	*
SC			*	*	*	*	*	*	*	*
CB				.26	.05	.01	.01	.006	.002	.002
RA					.15	.04	.04	.02	.006	.006
CA						.21	.17	.11	.04	.02
UA							>.40	.32	.19	.07
UB								.38	.27	.09
UC									>.40	.14
SA										.14

Total Hits on Targets										
	CB	CA	SB	SC	RA	UC	UB	UD	UA	SA
CB		.24	.26	.16	.08	.04	.13	.91	.01	.004
CA			>.40	.36	.15	.09	.05	.02	.02	.004
SB				>.40	.31	.23	.19	.12	.11	.05
SC					.21	.13	.07	.02	.03	.004
RA						.37	.30	.13	.13	.03
UC							>.40	.24	.22	.06
UB								.23	.21	.04
UD									>.40	.08
UA										.16

Note: Standard Scores computed from raw scores using scores to three decimal places.  
 Variance and standard deviation if mixes SC and SB is zero and no distribution exists therefore probability values cannot be computed.  
 UA - 9 M14 Rifles  
 UB - 7 M14 Rifles/2 M14E2 AR  
 UC - 5 M14 Rifles/2 M60 MG  
 UD - 9 M14E2 Rifles  
 CA - 9 Colt Rifles  
 CB - 7 Colt Rifles/2 Colt AR  
 SA - 9 Stoner Rifles  
 SB - 7 Stoner Rifles/2 Stoner AR  
 SC - 7 Stoner Rifles/2 Stoner MG  
 RA - 9 AK47 Rifles  
 $\bar{X}$  - Mean (Average)  
 SD - Standard Deviation  
 CET - Cumulative Exposure Time  
 z' - Standard Score (X = 50, SD = 20)

**C**

Statistical Data  
(Cumulative Exposure Times)

Unit	Mix	Mean	SD	Standard Score	Time (Min)
CB	96.8	1.0	80.8	154.1	
CA	91.4	2.2	78.8	95.8	
CB	77.1	5.4	59.6	35.9	
SA	72.5	6.7	54.0	29.9	
SC	72.4	8.2	53.9	29.8	
SB	74.7	7.4	53.1	29.1	
UC	59.1	14.5	37.9	20.1	
RA	59.1	5.2	37.9	20.1	
UB	50.1	12.9	27.1	18.5	
UD	43.1	7.5	19.7	14.5	
$\bar{x}$	69.12				
$\sigma$	16.64				

**COLLATERAL PERFORMANCE MEASURES**

**D** Number of Targets Hit

Mix	% Targets Hit	Standard Score	
CB	58.0	0.9	77.4
CA	56.0	0.0	77.4
CB	54.4	4.1	69.5
RA	52.8	4.8	61.3
CA	50.2	3.7	48.4
UA	48.5	3.4	37.6
UB	48.1	3.7	37.8
UC	47.5	3.6	34.6
SA	47.0	1.8	32.4
UD	44.9	4.1	21.8
$\bar{x}$	50.54		
$\sigma$	4.00		

**E** Total Hits on Targets

Mix	% Hits	SD	Standard Score
CB	90.5	17.0	84.0
CA	84.5	11.5	69.1
SB	82.5	23.0	64.3
SC	82.2	10.1	63.4
RA	78.7	11.5	49.9
UC	74.2	12.2	43.9
UB	73.4	8.4	41.8
UA	70.2	5.8	33.8
SA	69.2	8.7	31.4
CA	64.1	9.1	18.7
$\bar{x}$	76.74		
$\sigma$	8.10		

**B** Cumulative Exposure Time

Unit	SC	SB	CA	UA	SA	RA	UB	UC	UD
CB	.05	.11	.06	.006	.004	.004	.000	.000	.003
CA	>.40	.35	.15	.08	.02	.006	.003	.02	
CB	>.40	.30	.21	.09	.04	.04	.03		
CA		.40	.27	.11	.05	.04	.04		
UA			.25	.05	.01	.01	.02		
SA				.13	.04	.05	.05		
RA					.36	.33	.19		
UB						.40	.22		
UC							.24		
UD								.24	

**I** Number of Near Misses

Unit	SC	SB	CA	UA	SA	RA	UB	UC	UD
CB									
CA									
SB									
SC									
RA									
UA									
SA									
RA									
UB									
UC									
UD									

**J** No. of Targets Hit

Unit	SC	CB	RA	CA	UA	UB	UC	SA	UD
CB	*	*	*	*	*	*	*	*	*
CA		*	*	*	*	*	*	*	*
SB			.26	.05	.01	.01	.006	.002	.002
SC			.15	.04	.04	.02	.006	.006	
RA				.21	.17	.11	.04	.02	
UC					>.40	.32	.19	.07	
UB						.34	.27	.09	
UD							.40	.14	
UA								.14	

**L** Total Hits on Targets

Unit	CB	CA	SB	SC	RA	UC	UB	UD	UA	SA
CB	.24	.26	.16	.08	.04	.13	.01	.01	.004	
CA		>.40	.36	.15	.09	.05	.02	.02	.004	
SB			>.40	.31	.23	.19	.12	.11	.05	
SC				>.40	.21	.13	.07	.02	.02	.004
RA					>.40	.37	.30	.13	.13	.03
UC						>.40	.24	.22	.06	
UB							>.40	.23	.21	.04
UD								>.40	.09	
UA									>.40	.16

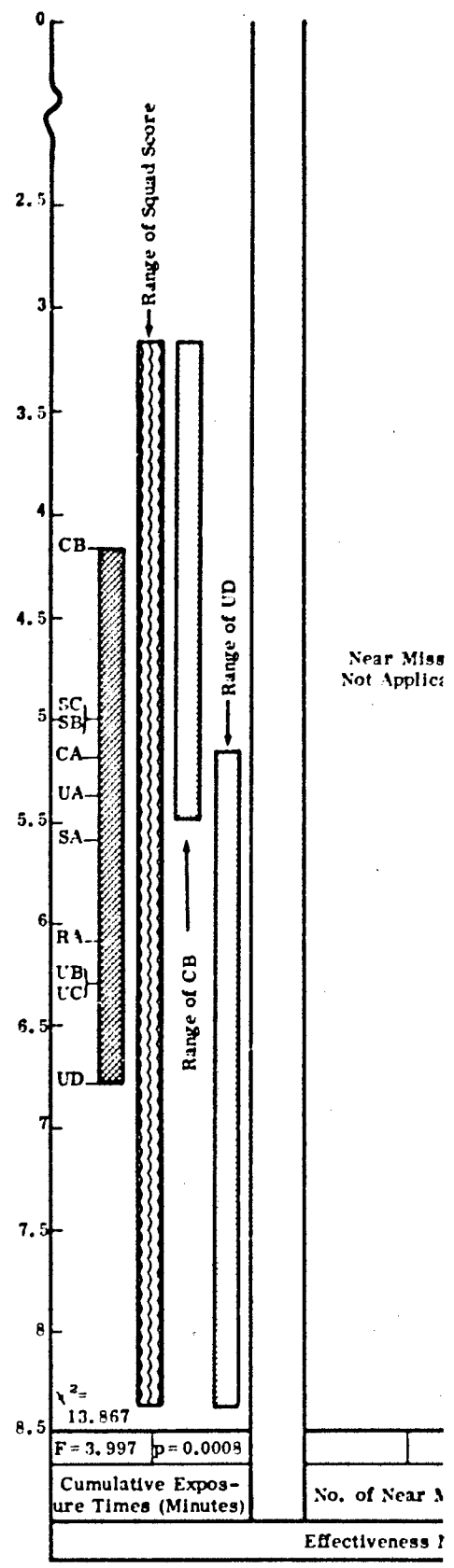

\*14 Rifles  
 \*14 Rifles/2 M14E2 AR  
 \*14 Rifles/2 M60 MG  
 \*14E2 Rifles  
 \*olt Rifles

CB - 7 Colt Rifles/2 Colt AR  
 SA - 9 Stoner Rifles  
 SB - 7 Stoner Rifles/2 Stoner AR  
 SC - 7 Stoner Rifles/2 Stoner MG  
 RA - 9 AK47 Rifles

$\bar{x}$  - Mean (Average)  
 SD - Standard Deviation  
 CET - Cumulative Exposure Time  
 $\sigma^2$  - Standard Score ( $\bar{x} = 50, SD = 20$ )

Figure 6-

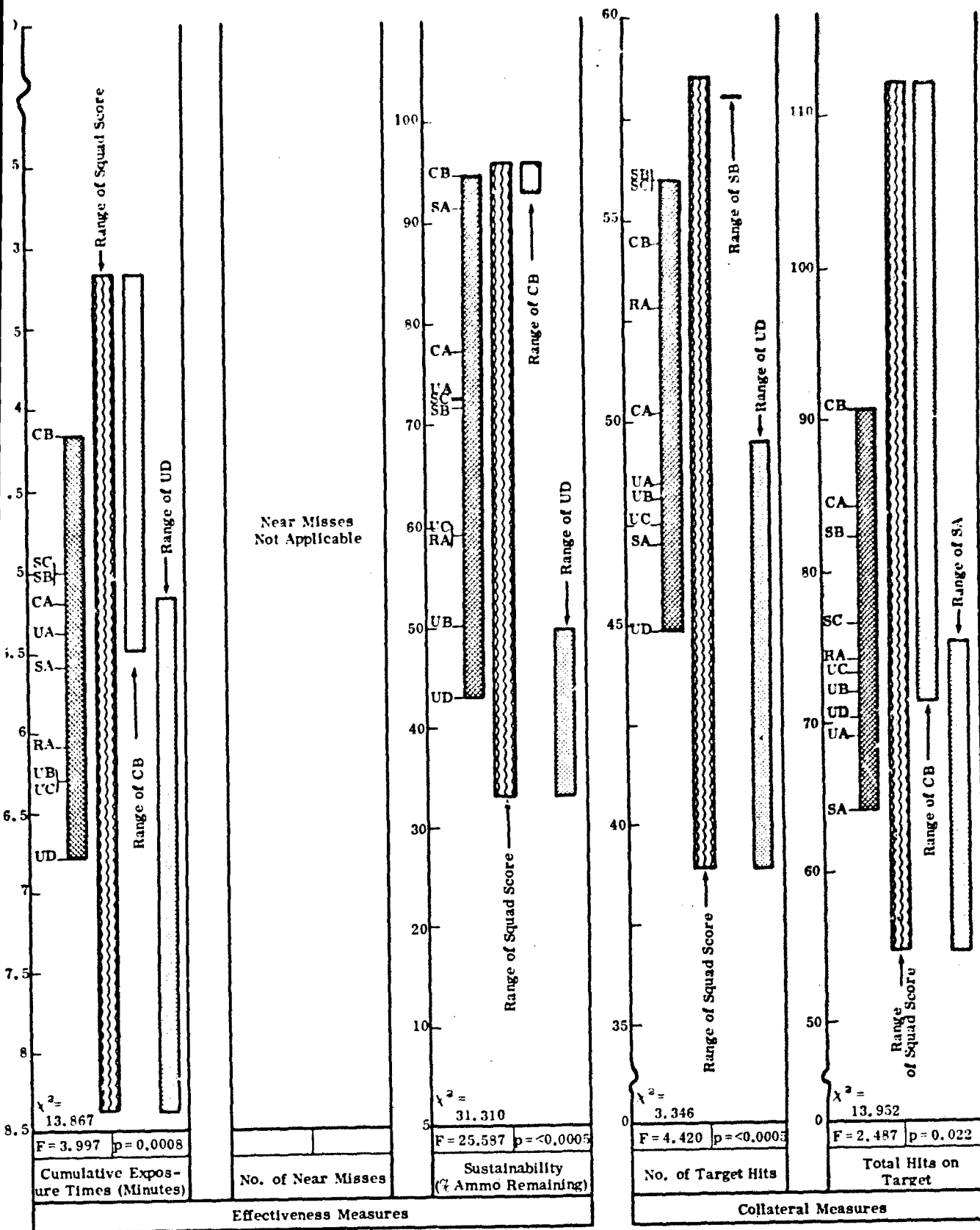

Figure 6-16 SUMMARY OF RESULTS--SITUATION 7

**BLANK PAGE**

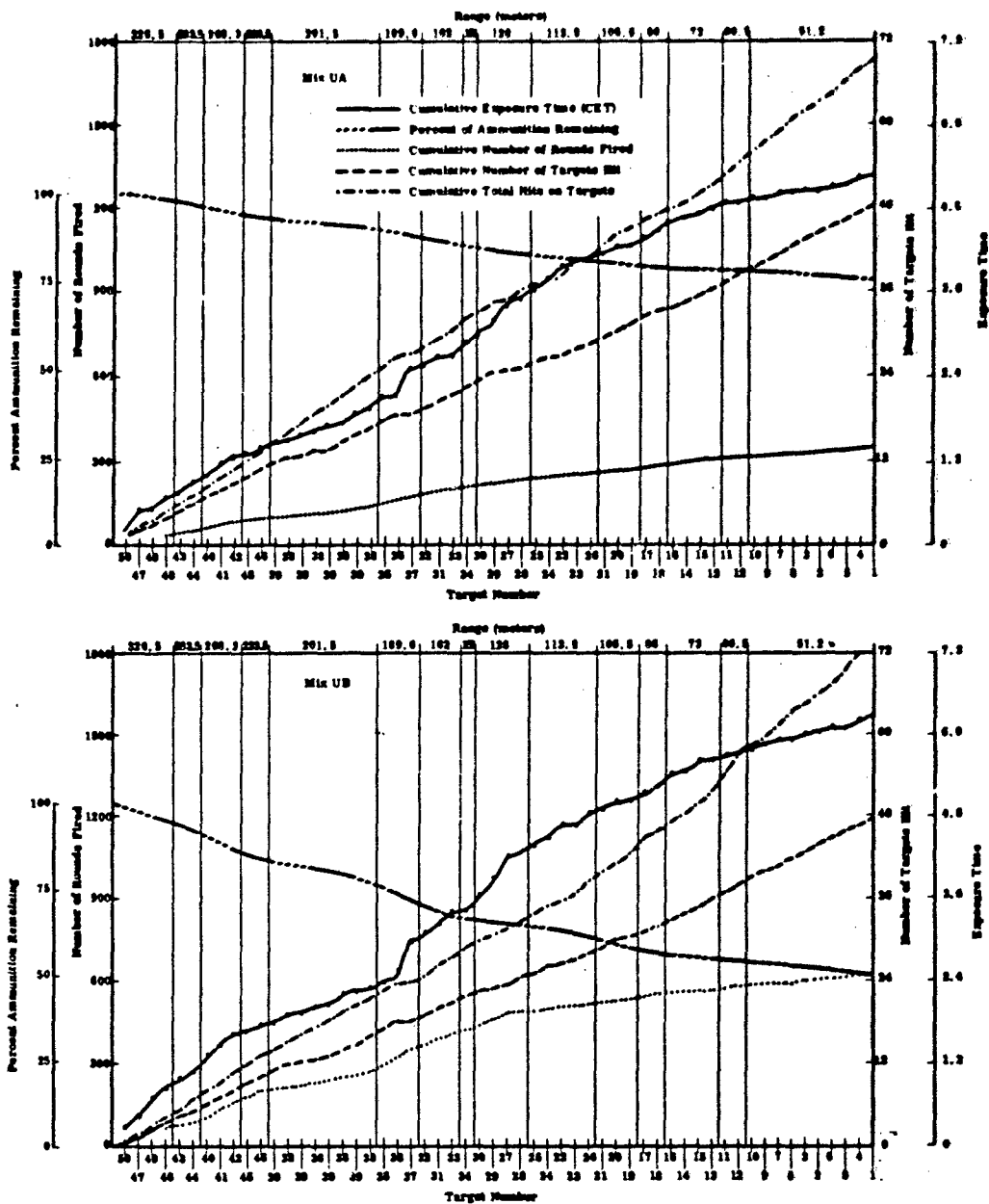

Figure 6-17

CUMULATIVE EXPOSURE TIME, TARGETS HIT, ROUNDS FIRED, TOTAL HITS, AND PERCENT OF AMMUNITION REMAINING--SITUATION 7

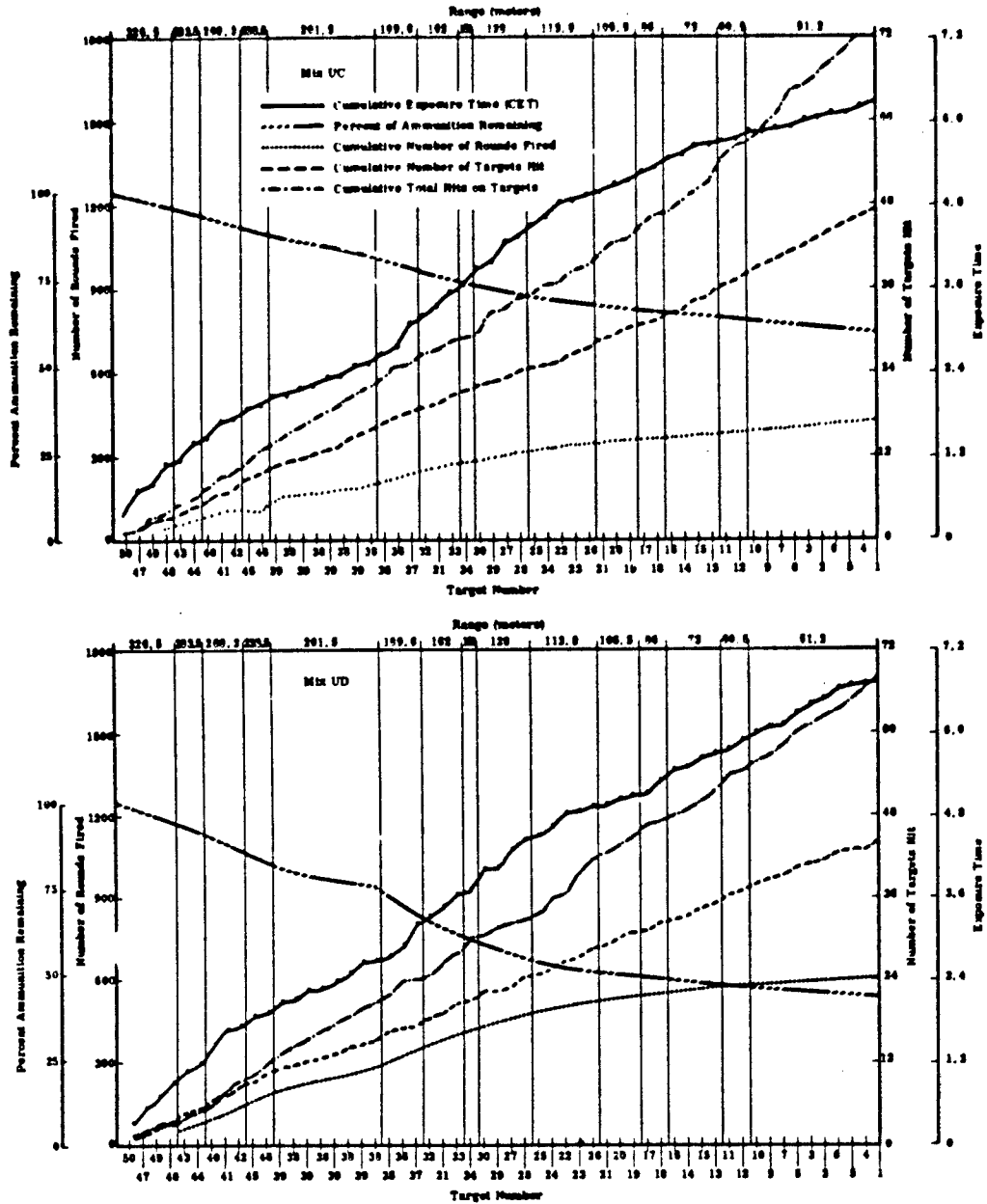

Figure 6-17 (Continued)

CUMULATIVE EXPOSURE TIME, TARGETS HIT, ROUNDS FIRED, TOTAL HITS, AND PERCENT OF AMMUNITION REMAINING--SITUATION 7



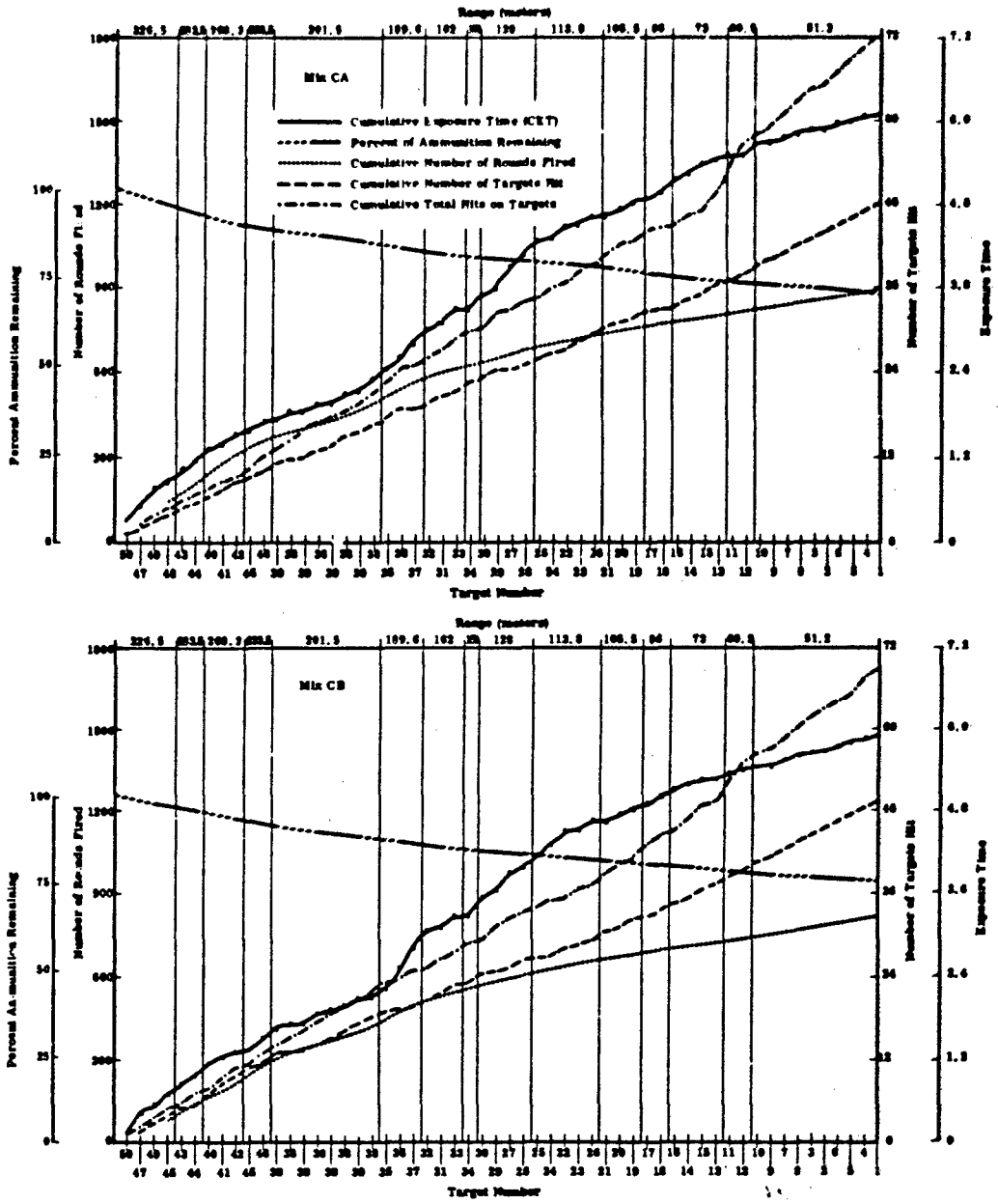

Figure 6-17 (Continued)

CUMULATIVE EXPOSURE TIME, TARGETS HIT, ROUNDS FIRED, TOTAL HITS, AND PERCENT OF AMMUNITION REMAINING--SITUATION 7

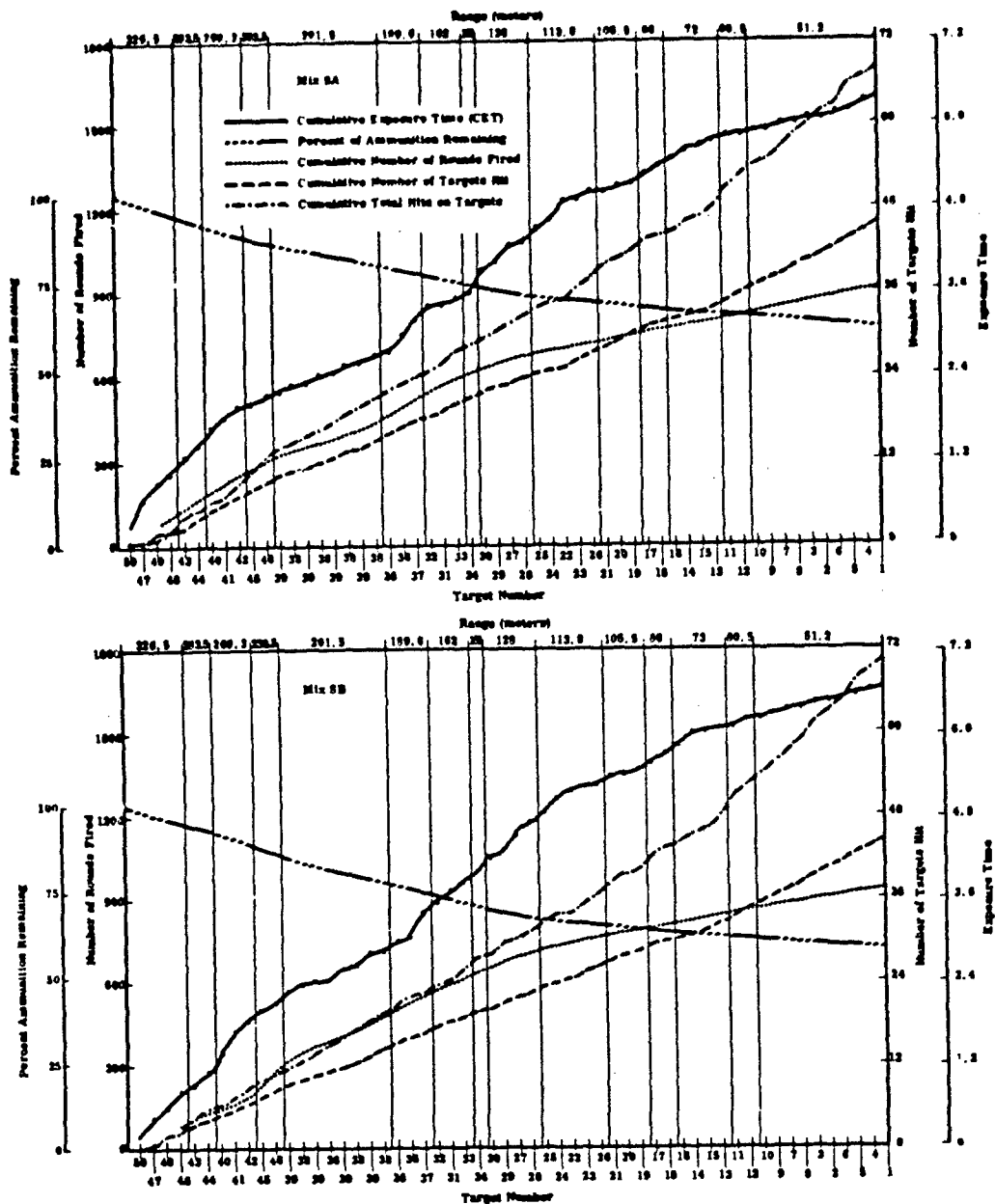

Figure 6-17 (Continued)

CUMULATIVE EXPOSURE TIME, TARGETS HIT, ROUNDS FIRED, TOTAL HITS, AND PERCENT OF AMMUNITION REMAINING--SITUATION 7

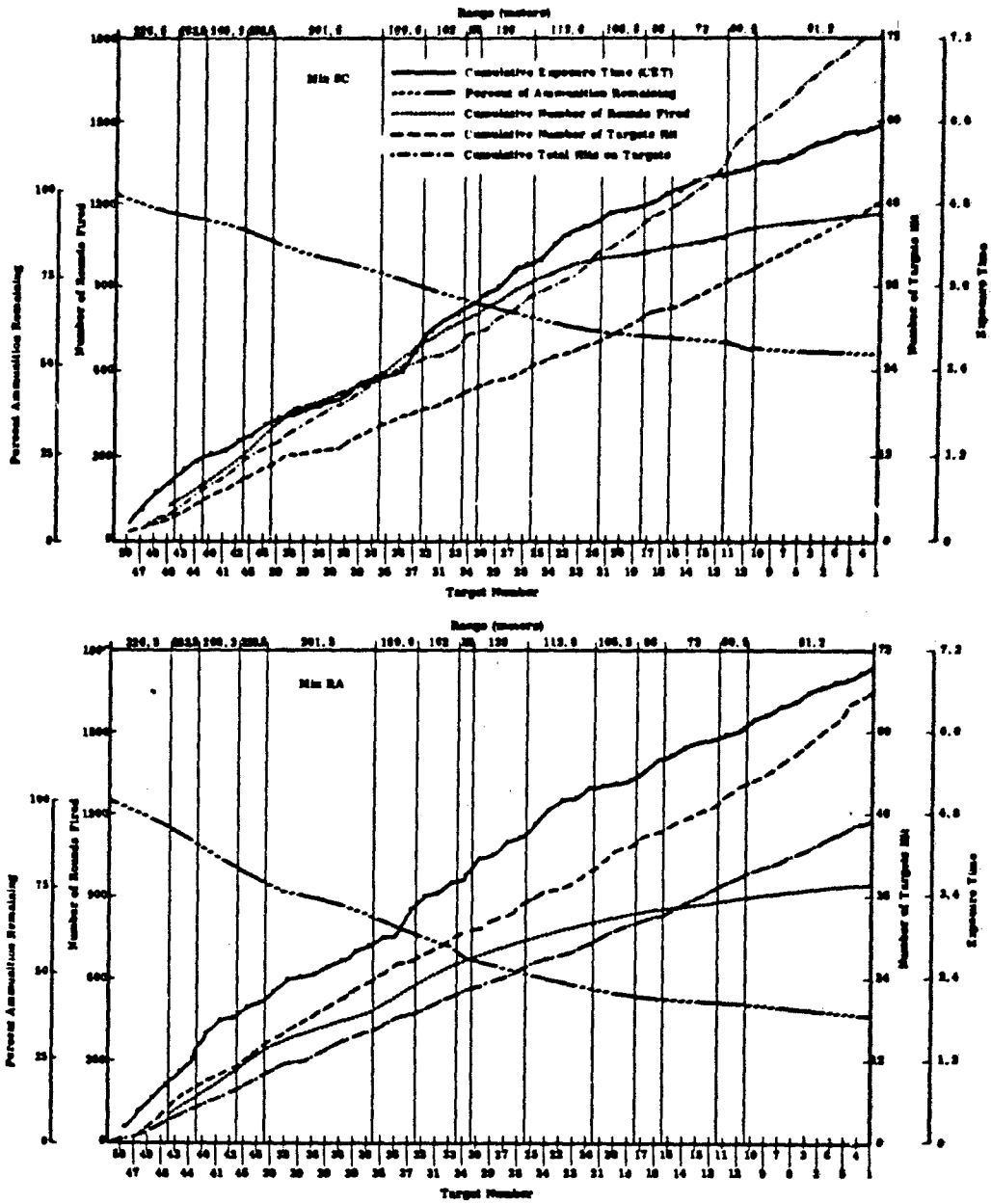

Figure 6-17 (Concluded)

CUMULATIVE EXPOSURE TIME, TARGETS HIT, ROUNDS FIRED, TOTAL HITS, AND PERCENT OF AMMUNITION REMAINING--SITUATION 7

6. Situation 8: Rifle Squad in Night Defense Against Attack

Rifle squad weapon mixes fired from hastily prepared foxholes at enemy targets raised for fixed exposure times in sequence beginning at a range of 235 meters from the firers and ending with a ten-man final assault at 45 meters. The cycle was then repeated with targets coming up in a different sequence the second cycle. This represented a regrouping for a second attack and provided a broader data base. In this situation the enemy targets were not visible to the firers because of darkness, and cues were simulator flash and sound. The duration of the situation was 4.8 minutes for both cycles combined.

As in Situation 7, a second series (not to be confused with the second cycle discussed above) was fired to determine the better mode of fire (semiautomatic or automatic) for the different rifles. Because of the variability of scores, however, it was not possible to conclude that one mode was better than the other for any weapon in this night situation. For example, although the M14 rifles that were fired at night in the automatic mode increased their target effects approximately 17.4 percent, they were still not superior to the low impulse weapons and expended 26.4 percent more ammunition to achieve the gain. It was therefore judged that the proper mode of fire for the M14 at night under circumstances similar to those of Situation 8 is semiautomatic. In like manner, there was no reason for concluding that the other rifles had not fired in their best mode in Series 1; therefore, Series 2 scores were not integrated with Series 1 scores.

Results for the ten mixes (other than Mix RC) are presented in Figure 6-18. Figure 6-19 illustrates CET as a function of target range for Cycles 1 and 2. On each cycle the range is decreasing as the attack progresses toward the weapon positions.

Results for the ten mixes (other than Mix RC) are presented in the following tables and graphs. The rank order of ten mixes with associated standard scores is presented below.

Target Effects Only			Overall Effectiveness*		
Rank	Mix	Standard Score	Rank	Mix	Standard Score
1	SB	74.6	1	CB	70.9
2	SC	71.9	2	SB	69.5
3	CB	66.9	3	SC	65.2
4	SA	65.8	4	SA	64.1
5	CA	48.9	5	CA	58.4
6	UB	46.2	6	UC	45.6
7	UC	43.5	7	UB	43.1
8	UA	43.5	8	UA	42.5
9	RA	23.5	9	RA	21.5
10	UD	15.4	10	UD	19.5

\* Sustainability weighted 1/3; Target effects 2/3

Key:

UA - 9 M14 Rifles	SB - 7 Stoner Rifles and 2 Stoner AR
UD - 9 M14E2 Rifles	SC - 7 Stoner Rifles and 2 Stoner MG
UB - 7 M14 Rifles and 2 M14E2 AR	CA - 9 Colt Rifles
UC - 5 M14 Rifles and 2 M60 MG	CB - 7 Colt Rifles and 2 Colt AR
SA - 9 Stoner Rifles	RA - 9 AK47 Rifles
RC - 7 AK47 Rifles and 2 RPD MG	

Mix RC results for Situation 8 are presented below.

CET	Near Misses	Percent Ammo Remaining	Targets Hit	Total Hits
6.73	--	20.00	19.40	28.80

**A Cumulative Exposure Times**

Mix	$\bar{X}$ CET	SD	Standard Score $z^*$
SB	6.03	.4	74.6
SC	6.10	.6	71.9
CB	6.23	.4	66.9
SA	6.26	.2	65.8
CA	6.70	.5	48.9
UB	6.77	.4	46.2
UC	6.84	.6	43.5
UA	6.84	.3	43.5
RA	7.36	.6	23.5
UD	7.57	.5	15.4
$\bar{X}$	6.67		
SD	.52		

**B Number of Near Misses**

Mix	$\bar{X}$ Near Misses	SD	Standard Score $z^*$
SB			
SC			
CB			
SA			
CA			
UB			
UC			
UA			
RA			
UD			
$\bar{X}$			
SD			

**C Sustainability (Ammo Remaining)**

Mix	$\bar{X}$ % Remaining	SD	Standard Score $z^*$	Sustainability Time (Min)
CB	69.4	4.2	74.8	13.6
CA	68.6	4.9	77.4	15.2
SA	58.3	2.4	60.6	11.4
SB	57.4	9.5	59.2	11.2
SC	52.9	3.9	51.8	10.1
UC	51.6	10.5	49.7	9.9
UA	46.0	4.6	40.5	8.8
UB	43.7	3.4	36.8	8.5
UD	38.1	3.1	27.6	7.7
RA	21.9	6.5	17.5	7.0
$\bar{X}$	51.8			
SD	12.25			

**D Number of Targets Hit**

Mix	$\bar{X}$ Targets Hit	SD	Standard Score $z^*$
CB	25.5	4.3	76.0
SB	24.7	5.3	71.4
SA	23.8	3.6	66.3
SC	23.6	5.0	65.2
UB	27.3	3.0	52.1
CA	20.7	3.2	48.6
UA	19.8	2.9	43.5
UC	18.3	3.9	35.0
RA	16.4	5.0	24.1
UD	15.3	5.0	17.9
$\bar{X}$	20.94		
SD	3.51		

**E Total Hits on**

Mix	$\bar{X}$ Hits	SD	Standard Score $z^*$
SC	38.0	1.0	
CB	37.8	1.0	
SB	35.7	1.0	
SA	35.4	1.0	
CA	31.3	1.0	
UB	28.3	1.0	
UA	22.8	1.0	
UC	22.2	1.0	
RA	19.6	1.0	
UD	19.2	1.0	
$\bar{X}$	29.03		
SD	7.59		

**F Target Effects**

Mix	Standard Score Target Effects
SB	74.6
SC	71.9
CB	66.9
SA	65.8
CA	48.9
UB	46.2
UC	43.5
UA	43.5
RA	23.5
UD	15.4

**G Overall Effectiveness**

Mix	Overall Fire Effectiveness
CB	70.9
SB	69.5
SC	65.2
SA	64.1
CA	58.4
UC	45.6
UB	43.1
UA	42.5
RA	21.5
UD	19.5

**H Cumulative Exposure Time**

	SB	SC	CB	SA	CA	UB	UC	UA	RA	UD
SB		>.40	.29	.27	.05	.03	.03	.02	.007	.002
SC			.33	.28	.04	.02	.03	.01	.005	.001
CB				>.40	.05	.02	.03	.01	.003	.001
SA					.05	.02	.03	.005	.004	.001
CA						.39	.32	.28	.04	.008
UB							>.40	.38	.04	.01
UC								>.40	.09	.02
UA									.05	.01
RA										.28

**I Number of Near Misses**

**J Sustainability (Ammo Remaining)**

	CB	CA	SA	SB	SC	UC	UA	UB	UD	RA
CB		.37	.001	.01	.001	.003	.001	.001	.001	.001
CA			.002	.02	.001	.004	.001	.001	.001	.001
SA				>.40	.02	.10	.001	.001	.001	.001
SB					.17	.17	.02	.004	.001	.001
SC						>.40	.02	.002	.001	.001
UC							.13	.06	.008	.004
UA								.18	.004	.002
UB									.009	.003
UD										.03

**K No. of Targets Hit**

	CB	SB	SA	SC	UB	CA	UA	UC	RA	UD
CB		.39	.25	.26	.04	.03	.02	.009	.005	.003
SB			.38	.37	.11	.08	.04	.02	.02	.006
SA				>.40	.13	.08	.04	.03	.02	.008
SC					.19	.14	.08	.04	.03	.02
UB						.36	.20	.09	.04	.02
CA							.32	.14	.06	.03
UA								.24	.10	.04
UC									.25	.14
RA										.37

**L Total Hits on Targets**

	SC	CB	SB	SA	CA	UB	UA	UC
SC		>.40	.51	.34	.14	.04	.005	.008
CB			.37	.35	.15	.02	.001	.001
SB				.38	.35	.05	.004	.005
SA					.19	.02	.001	.003
CA						.20	.02	.02
UB							.003	.01
UA								.38
UC								

Note: Standard Scores computed from raw scores using scores to three decimal places.

UA - 9 M14 Rifles  
 UB - 7 M14 Rifles/2 M14E2 AR  
 UC - 5 M14 Rifles/2 M60 MG  
 UD - 9 M14E2 Rifles  
 CA - 9 Colt Rifles

CB - 7 Colt Rifles/2 Colt AR  
 SA - 9 Stoner Rifles  
 SB - 7 Stoner Rifles/2 Stoner AR  
 SC - 7 Stoner Rifles/2 Stoner MG  
 RA - 9 AK47 Rifles

$\bar{X}$  - Mean (Average)  
 SD - Standard Deviation  
 CET - Cumulative Exposure T  
 $z^*$  - Standard Score ( $X = 50$ )



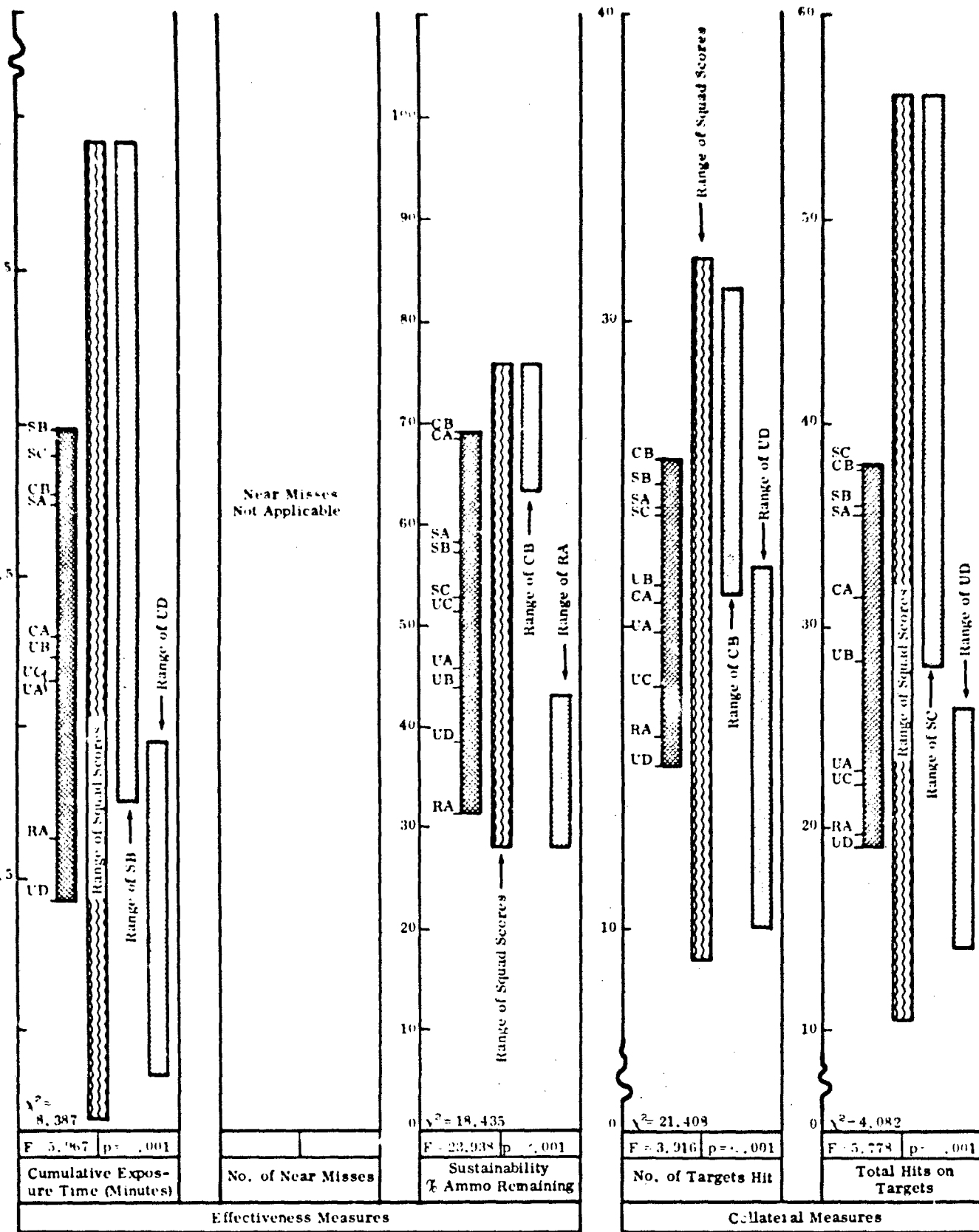

Figure 6-18 SUMMARY OF RESULTS--SITUATION 8



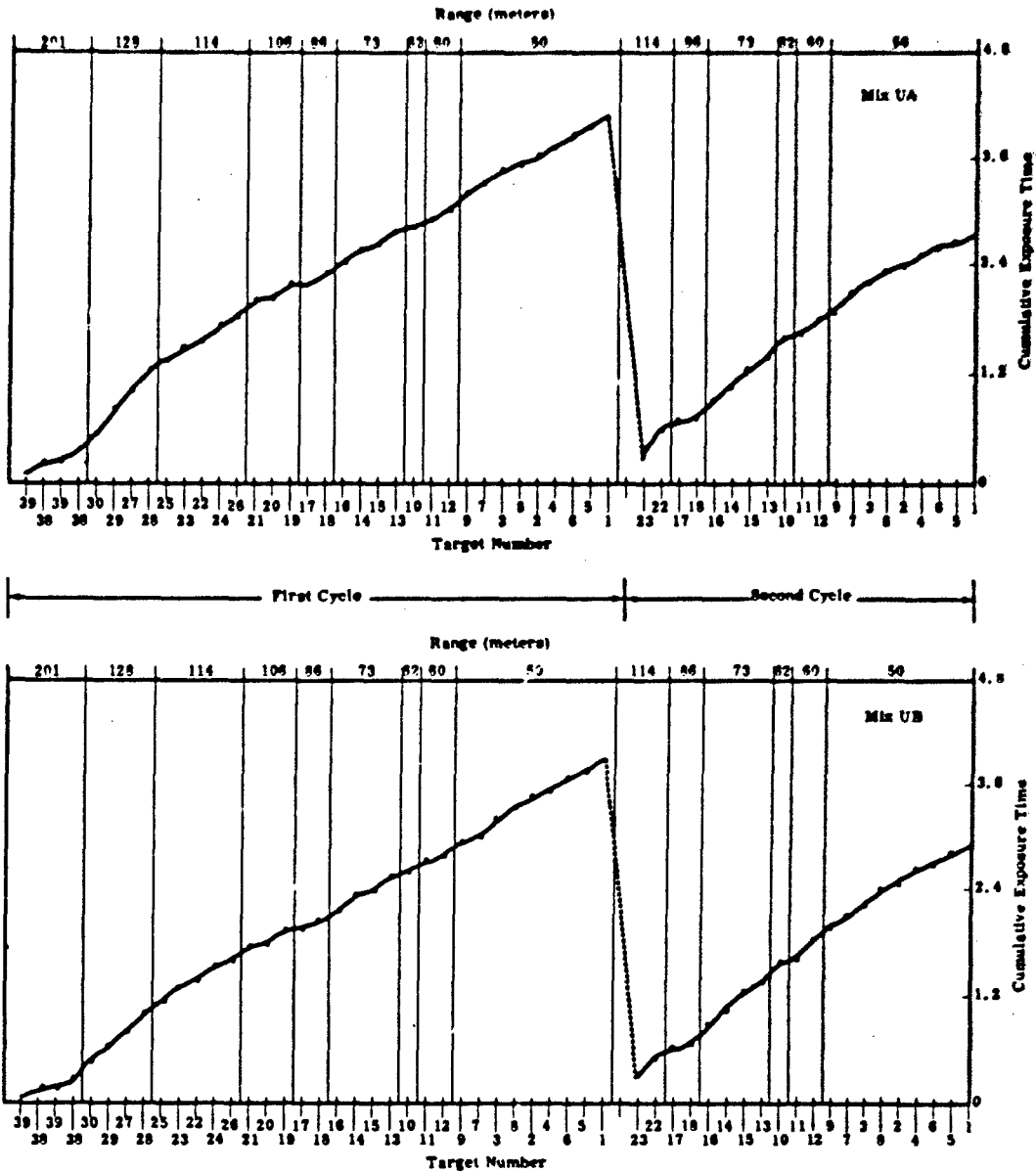

Figure 6-19  
CUMULATIVE EXPOSURE TIME--SITUATION 8

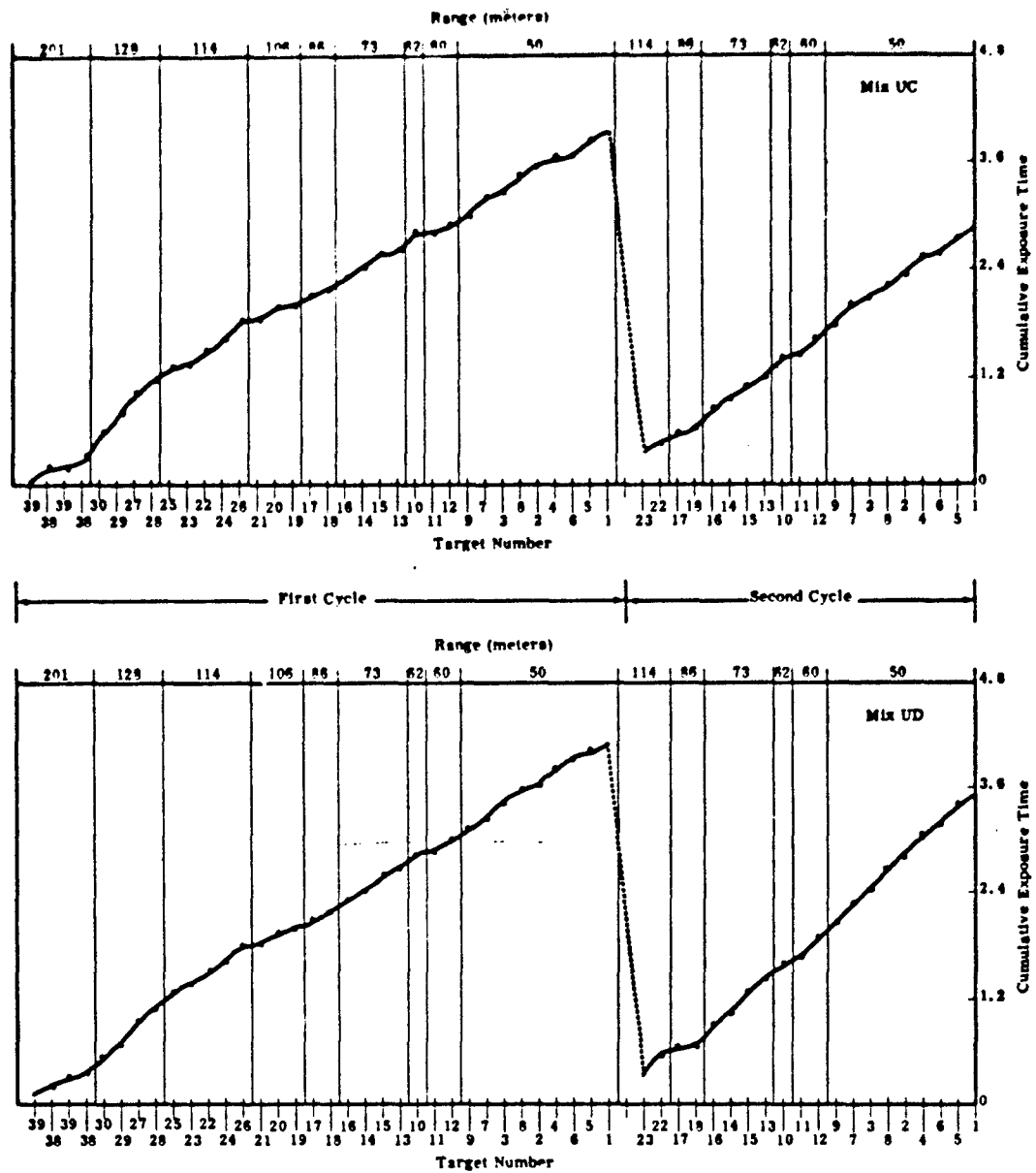

Figure 6-19 (Continued)  
CUMULATIVE EXPOSURE TIME--SITUATION 8

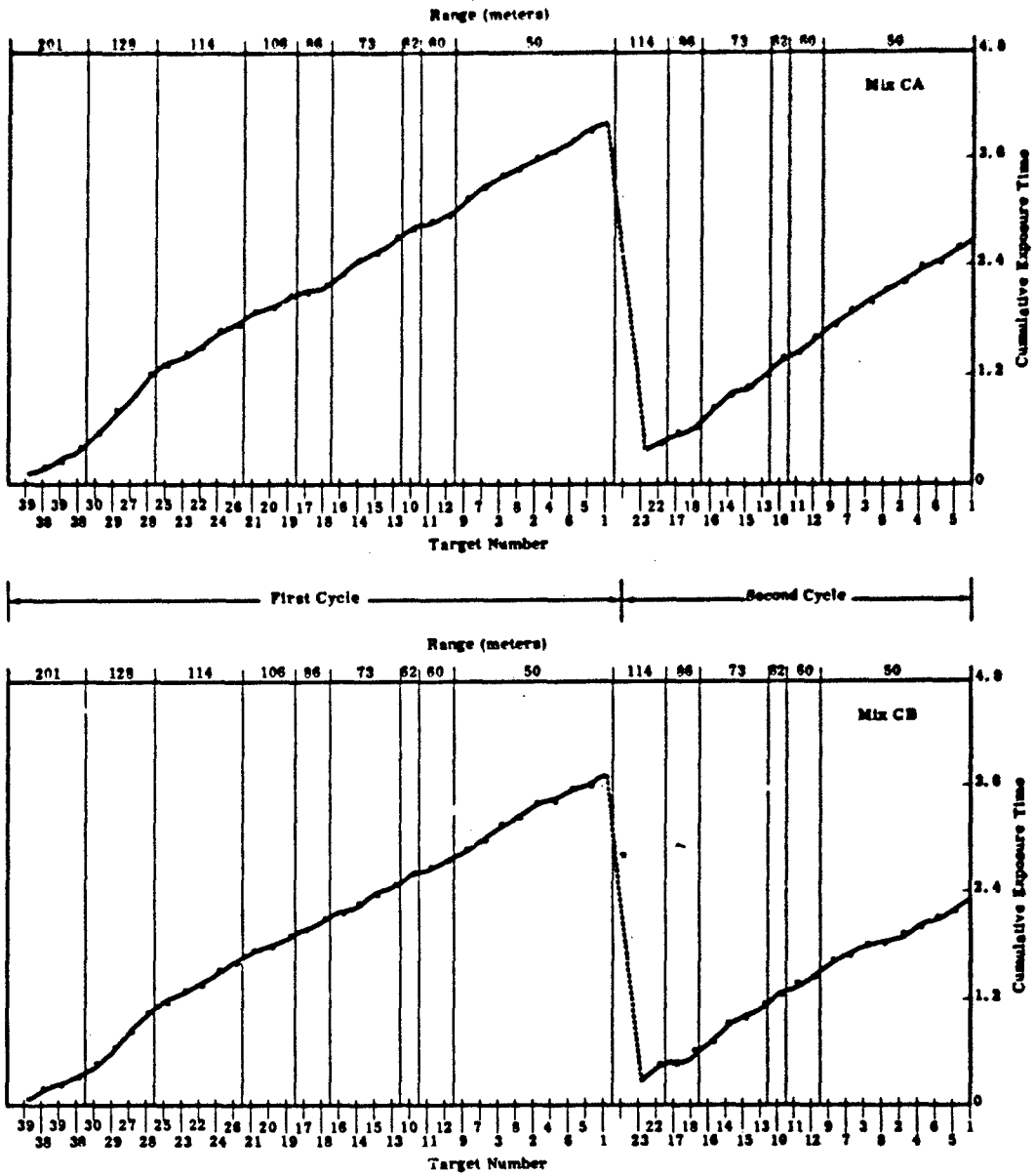

Figure 6-19 (Continued)  
CUMULATIVE EXPOSURE TIME--SITUATION 8

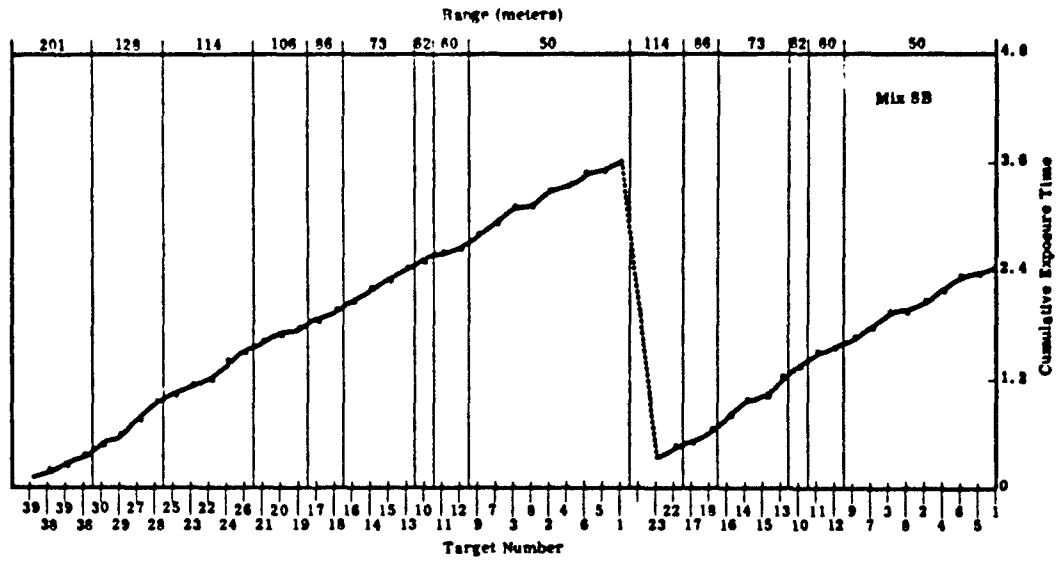
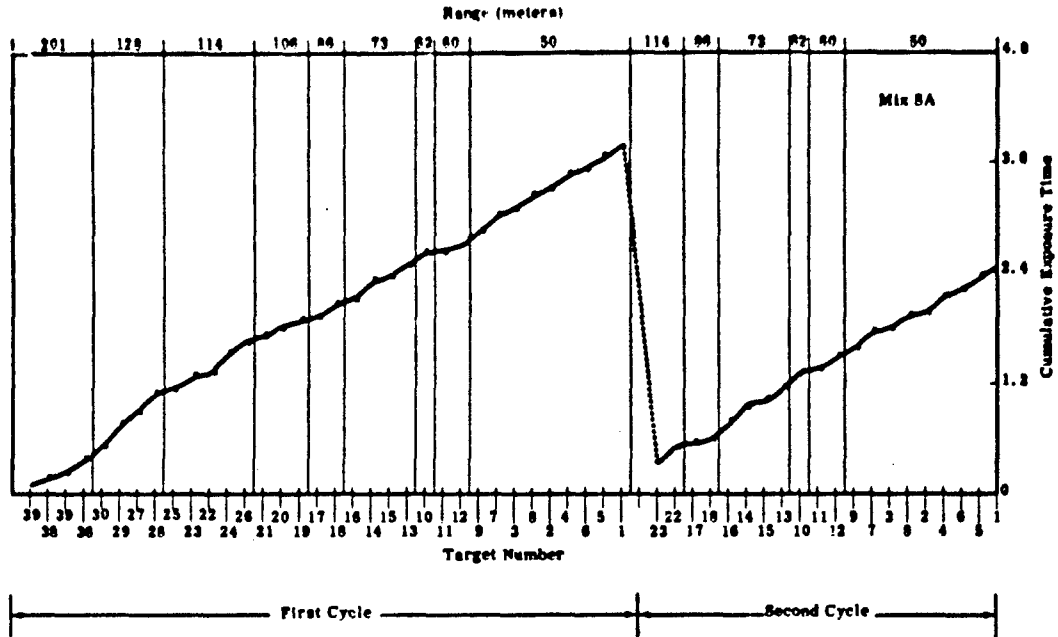

Figure 6-19 (Continued)  
CUMULATIVE EXPOSURE TIME--SITUATION 8

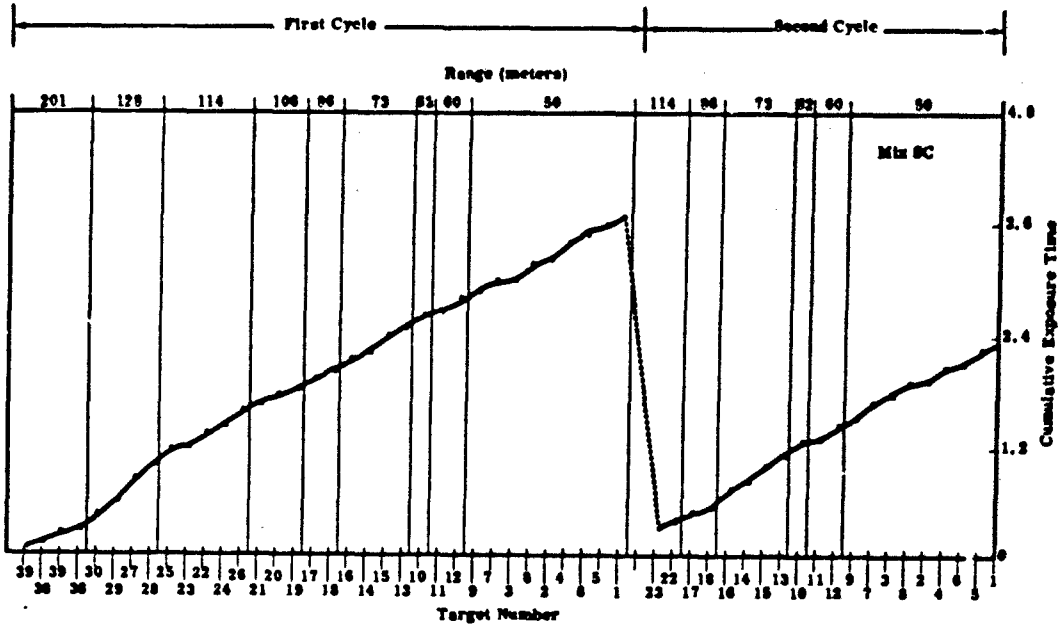

Figure 6-19 (Continued)  
CUMULATIVE EXPOSURE TIME--SITUATION 8

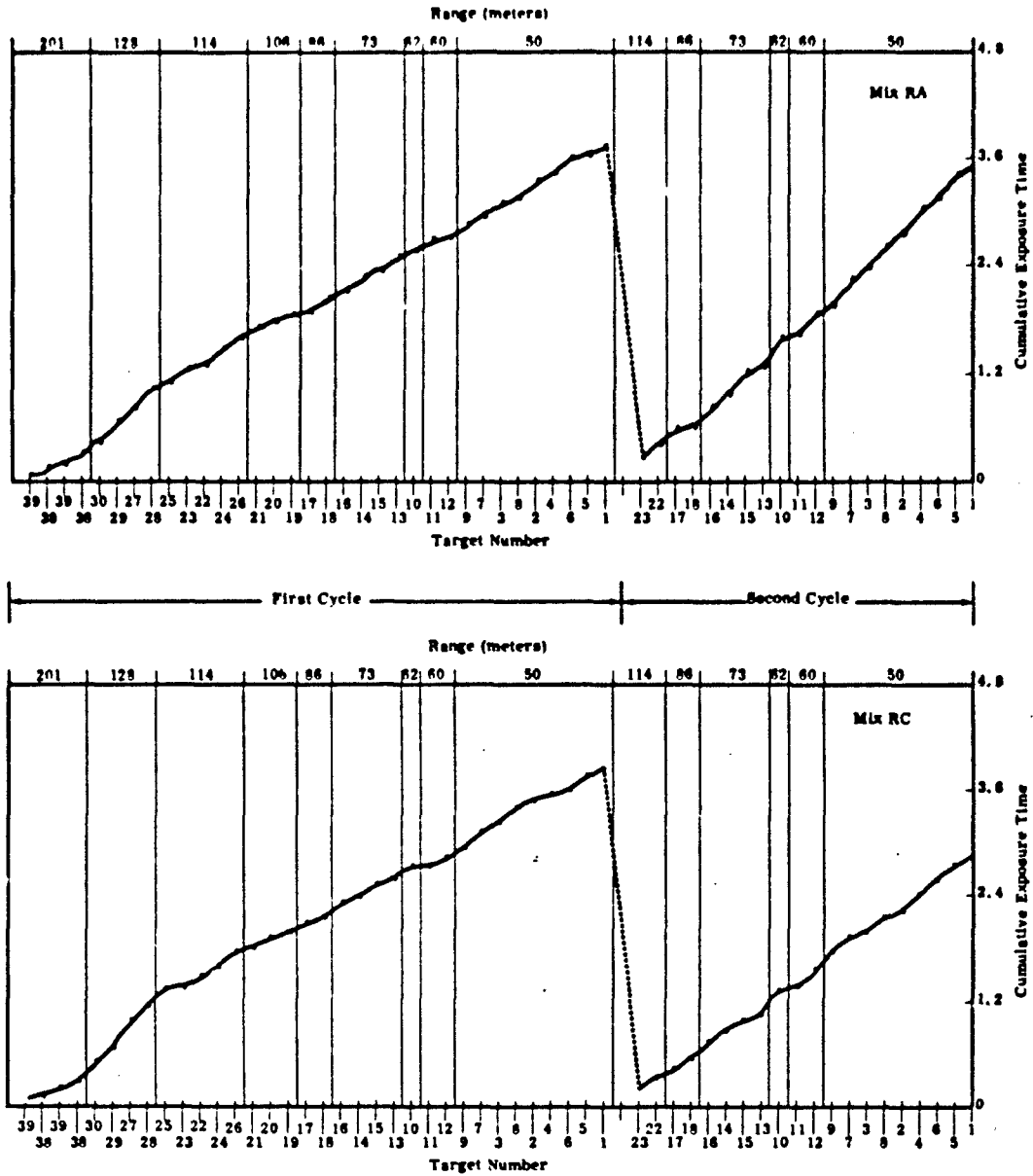

Figure 6-19 (Concluded)  
CUMULATIVE EXPOSURE TIME--SITUATION 8

## 7. Combined Results - Rifle Squad Experiment

Target effects and overall effectiveness scores were averaged, for illustrative purposes, across all six rifle situations, with each situation arbitrarily assigned a weight of equal importance. This does not imply that each situation should be weighted equally. The numerical values presented below do little more than serve as a base for varying the judged value of the different situations. In like manner, overall standard scores for each situation should be considered the result of arbitrarily weighting target effects two-thirds and sustainability one-third.

Sensitivity analyses have shown, however, that the rank orders of the weapon systems are remarkably insensitive to changes in weighting. For example, because Mix UC (five M14 rifles and two M60 machineguns) never ranks higher in target effects than seventh place in any situation, Mix UC can never rank higher than the bottom half in target effects, no matter how much weight is given to a particular situation. Mix UC was also inferior in target effects to Mix UA (composed entirely of M14 rifles) in every situation but the night defense, and even in this situation Mix UC was in seventh place, with Mix UB in sixth place and Mix UA a close eighth. In overall effectiveness, Mix UA was also superior to Mix UC in five of the six situations. It is therefore concluded that the M60 machinegun is not satisfactory for inclusion in the rifle squad.

The deficiencies of the M60 machinegun and its low standing among other weapon mixes are attributed to the heavy system weight that required a two-man crew, the difficulty of managing such a heavy weapon in the moving firing situations, and the fact that even with a two-man crew its sustainability is marginal.

The opposite is true for Mix SC (seven Stoner rifles and two Stoner machineguns). This mix was among the top three in target effects in every situation. It was also superior in target effects to every US 7.62mm weapon mix, regardless of the situation. In sustainability, it dropped in rank order, but in overall effectiveness combined across all situations, it ranked fourth, again superior to every US 7.62mm mix. This was despite the Stoner machinegun being subject to numerous malfunctions and stoppages caused by faulty ammunition and improperly manufactured belt links. It was nevertheless still able to finish first in combined target effects for all situations. It is therefore concluded that the Stoner machinegun can be feasibly included in the rifle squad in the automatic rifle role, or possibly in a new squad organization in the role of a machinegun.

Mix UA (composed entirely of M14 rifles) is superior to all other US 7.62mm mixes in target effects, sustainability, and overall effectiveness, while Mix UB (seven M14s and two M14E2) and Mix UD (nine M14E2s) are seventh and ninth, respectively, in target effects,

and seventh and tenth in overall effectiveness. It is therefore concluded that a squad equipped entirely with M14 rifles is superior to a squad equipped with any other US 7.62mm weapon or combination of these weapons. In like manner, it is concluded that the M14E2 is not satisfactory for use in the rifle role.

It had been hypothesized before the experiment that the Colt rifle and similar weapons with straight stocks and high sights would be inferior in pointing fire, because the barrel is low in relation to the sights and because the weapon is short. This was not supported by experimentation data. To the contrary, Situation 4 (Approach to Contact), which was specifically developed to investigate pointing fire, shows that the top ranking mix in overall effectiveness was the mix composed of nine Colt rifles. This mix also ranked second in target effects. The variability of squads was large in this situation, and while Mix CA was first, Mix CB was only fifth in overall effectiveness and seventh in target effects. Although the variability of the rank orders and weapon system scores is too much to conclude that there is a real difference, the trend favors the Colt rifle with its high sight and straight stock.

The AK47 scores are low in all situations except in the pointing fire in Situation 4. However, it cannot be concluded that the low target effects of the AK47 rifle in this experiment are necessarily indicative of the performance of the AK47 in general. Its barrel is only 16 inches long and the sights are close together. It seems to be designed primarily as a submachinegun-type weapon. If the SAWS results were weighted by range in accordance with the frequency of ranges of actual combat, it would be expected to do much better. These weapons had also received heavier wear than the other experimentation weapons. They had all been well used when received for the SAWS experiment, and the number of rounds previously fired from them was unknown. Because of the limited number of weapons, five firers usually shared each weapon. There were no spares for worn or broken parts, except for other worn parts cannibalized from other weapons, and there was a variability in the design and quality of the ammunition. All of these things may have contributed to the relatively poor performance of the AK47.

The results in terms of rank order and standard scores for overall target effects and overall effectiveness across all situations are presented in the following tables.

These tables, examined in connection with the statistical tables and graphs for each situation, lead to the conclusion that low impulse 5.6mm weapons are markedly superior to high impulse 7.62mm weapons in target effects, sustainability, and overall effectiveness. Mix SC (seven Stoner rifles and two Stoner machineguns) was superior in target effects, while Mix CB (seven Colt rifles and two Colt machineguns) was outstanding in overall effectiveness. However, results of later



experimentation (described in Part B) indicate that a squad equipped with only Colt automatic rifles may be superior to any of the mixes listed in the tables here.

**TARGET EFFECTS ONLY**

Rank Order by Situation						
Rank	Situation					
	1	2	4	5	7	8
1	SB	CA	SC	SA	CB	SB
2	SA	SC	CA	CB	SC	SC
3	UB	UB	SB	SB	SB	CB
4	SC	UA	UA	SC	UA	SA
5	CB	CB	RA	UA	CA	CA
6	CA	UD	UB	UD	SA	UB
7	UA	SB	CB	UC	RA	UC
8	RA	UC	UD	CA	UB	UA
9	UC	SA	SA	UB	UC	RA
10	UD	RA	UC	RA	UD	UD

Rank Order (All Six Situations Combined)		
Rank	Mix	Std. Score
1	SC	63.35
2	CB	63.26
3	SB	60.30
4	SA	57.79
5	CA	53.70
6	UA	52.16
7	UB	46.61
8	UC	41.33
9	UD	34.93
10	RA	29.88

**OVERALL EFFECTIVENESS <sup>A</sup>**

Rank Order by Situation						
Rank	Situation					
	1	2	4	5	7 <sup>B</sup>	8
1	CB	CA	CA	SA	CB	CB
2	SB	CB	UA	CB	CA	SB
3	SA	UA	RA	SB	SC	SC
4	UB	SC	SC	SC	SB	SA
5	CA	UB	CB	CA	UA	CA
6	SC	UD	SB	UA	SA	UC
7	UA	SA	UB	UD	RA	UB
8	RA	SB	SA	UC	UC	UA
9	UD	UC	UC	RA	UB	RA
10	UC	RA	UD	UB	UD	UD

Overall Rank Order <sup>B</sup> (All Six Situations Combined)		
Rank	Mix	Std. Score
1	CB	67.70
2	CA	63.27
3	SA	59.47
4	SC	58.41
5	SB	58.23
6	UA	52.38
7	UB	45.32
8	UC	38.93
9	RA	35.12
10	UD	33.93

<sup>A</sup> Sustainability weighted 1/3; target effects weighted 2/3

<sup>B</sup> Series 1 Integrated Scores

**Key:**

UA - 9 M14 Rifles

UD - 9 M14E2 Rifles

UB - 7 M14 Rifles and  
2 M14E2 AR

UC - 5 M14 Rifles and  
2 M60 MG

SA - 9 Stoner Rifles

RC - 7 AK47 Rifles and  
2 RPD MG

SB - 7 Stoner Rifles and  
2 Stoner AR

SC - 7 Stoner Rifles and  
2 Stoner MG

CA - 9 Colt Rifles

CB - 7 Colt Rifles and  
2 Colt AR

RA - 9 AK47 Rifles

## B. SUPPLEMENTARY RIFLE SQUAD EXPERIMENT

Three special weapons mixes were fired in addition to the weapon mixes already described. These mixes were MC (seven Colt rifles and two Stoner machineguns), CY(S) (nine Colt automatic rifles), and CY(T) (nine Colt rifles). Three control mixes were fired: MB (seven Colt rifles and two Colt automatic rifles), CX(T) (nine Colt rifles), and CX(S) (nine Colt rifles). The (S) and (T) denote semiautomatic and two-round burst, respectively. The effects of these mixes for Situations 1, 2, 4, 5, 7, and 8 are presented in Table 6-1.

### 1. MC Versus MB

Analysis of the table shows that in terms of both target effects and sustainability there is a great deal of variation across the six rifle situations. Generally speaking, Mix MC is better in target effects in three of the six situations, although never by a tactically significant amount. In the other three situations, Mix MC and Mix MB are equal in target effects. In three of the six situations, however, MB is better than MC in sustainability, while in two situations the mixes are equal. Mix MC is slightly better (4 percent) in the remaining situation--an advantage that could be due to chance factors. Therefore, it is concluded that there are no tactically significant differences in overall effectiveness between Mix MC (seven Colt rifles and two Stoner machineguns) and Mix MB (seven Colt rifles and two Colt automatic rifles). In effect, as both mixes had seven rifles, it can be concluded that two Colt automatic rifles are equivalent to two Stoner machineguns. Note that in experimentation results for the September 1965 to December 1965 experimentation, it was concluded that the Stoner and Colt rifles were approximately equivalent in target effects. Also the scores of Mix SC (seven Stoner rifles and two Stoner machineguns) and Mix CB (seven Colt rifles and two Colt automatic rifles), when totalled for all six situations, were the two top ranking mixes with almost identical scores in overall target effects: 64.5 and 62.8. Thus the equivalence of Stoner rifles and Colt rifles, as well as Colt automatic rifles and Stoner machineguns, becomes apparent. When sustainability is considered, however, a mix composed of seven Colt rifles and two Colt automatic rifles becomes clearly superior in overall effectiveness.

### 2. CX Versus CY

Results show that Mix CY (nine Colt automatic rifles) is superior to Mix CX (nine Colt rifles) in terms of target effects achieved. However, this increase in target effects is traded for an approximate 11.5 percent loss in sustainability caused by the increased weight of the Colt automatic rifle. Mix CX (nine Colt rifles) is superior to Mix CY in sustainability. However, the Colt automatic rifle, although heavier than the Colt rifle, can still, within its 17-pound system weight, carry 265

**Table 6-1**  
**EFFECTS OF SPECIAL WEAPON MIXES**

Mix	CET (Minutes)	Near Misses	Sustainability	Target Hits	Total Hits
<b>Situation 1</b>					
MC	26.35	632.76	56.75	3.37	3.49
MB	26.82	590.34	64.43	3.69	3.96
CY(T)	25.86	593.81	61.45	4.06	4.56
CY(S)	25.92	571.39	64.08	5.64	5.64
CX(T)	26.84	529.67	68.86	2.28	2.28
CX(S)	25.50	441.57	71.26	4.91	5.43
<b>Situation 2</b>					
MC	82.20	421.25	31.25	9.00	9.20
MB	85.47	420.25	40.09	8.38	8.54
CY(T)	85.19	441.00	38.86	8.25	8.75
CY(S)	79.93	426.00	38.62	10.75	10.75
CX(T)	86.38	405.75	44.72	7.75	8.00
CX(S)	85.59	364.25	56.13	8.25	9.00
<b>Situation 4</b>					
MC	1.94	--	76.54	29.62	45.88
MB	2.00	--	78.08	30.50	50.12
CY(T)	1.91	--	73.01	32.00	52.75
CY(S)	1.97	--	87.86	32.25	52.50
CX(T)	1.91	--	77.85	31.00	46.75
CX(S)	1.82	--	90.61	31.75	45.75

Table 6-1  
EFFECTS OF SPECIAL WEAPON MIXES (Concluded)

Mix	CET (minutes)	Near Misses	Sustainability	Target Hits	Total Hits
Situation 5					
MB	32.99	257.50	63.78	12.12	13.76
MC	35.48	279.62	58.95	10.88	11.42
CY(T)	38.10	268.75	34.68	8.75	10.25
CY(S)	39.63	256.50	35.51	8.50	8.50
CX(T)	38.52	255.00	49.38	8.50	9.00
CX(S)	41.49	184.00	45.42	6.25	6.50
Situation 7					
MC	4.38	--	68.62	52.50	93.38
MB	4.39	--	64.82	53.50	94.63
CY(T)	4.60	--	71.03	50.25	87.25
CY(S)	4.76	--	84.75	51.50	83.00
CX(T)	5.01	--	75.61	51.50	80.25
CX(S)	4.61	--	85.18	51.25	78.25
Situation 8					
MC	5.47	--	55.41	31.13	55.25
MB	5.58	--	54.45	29.00	48.86
CX(T)	5.30	--	58.57	33.50	59.75
CX(S)	4.69	--	55.57	36.25	64.25
CY(T)	4.92	--	57.55	35.75	65.50
CY(S)	4.83	--	56.93	34.50	58.00

rounds as opposed to 100 for the M14, 180 for the Stoner rifle, and 300 for the Colt rifle. The additional weight of the barrel is equal to one full 30-round magazine plus five rounds. Thus, the Colt automatic rifle although able to carry 35 -rounds less ammunition than the Colt rifle, is still a lighter weapon, and can carry more ammunition than any of the other rifles or automatic rifles. The heavier barrel also allows the weapon to sustain its fire longer than the Colt rifle without damage to the barrel.

### 3. MC Versus CY

A comparison of Mix CY (nine Colt automatic rifles) with Mix MC (seven Colt rifles and two Stoner machineguns) shows the two mixes are approximately equal in target effects but that Mix CY has a slight advantage in sustainability. This portion of the experiment therefore indicated that the most feasible weapon mix may be one equipped entirely with Colt automatic rifles.

In all identical rifle situations during the entire experiment, mixes composed of nine rifles compared favorably, and did better in some cases, with mixes composed of seven rifles and two machineguns. Furthermore, when the scores secured by seven-man machinegun squads in the machinegun experiment are compared to the scores of the nine-man rifle squads in corresponding situations, the nine-man rifle squads are found generally superior to the machinegun squads in target effects, sustainability, and overall effectiveness. Table 6-2 compares the scores for the top ranking rifle squad mixes and the scores representing the average of all rifle squad mixes for each measure of each situation with the scores for the top ranking machinegun squad for each measure of each situation. Also given are the scores of the squad mix equipped entirely with Colt automatic rifles in their best mode of fire. The scores for the machinegun squads mix and the mix composed of Colt automatic rifles are inflated because some of their members had previously fired in the various situations in the original rifle squad experiment.

These factors lead to the hypothesis that seven riflemen should be more effective than a seven-man machinegun squad (two guns with a squad leader, two gunners, two assistant gunners, two ammunition bearers). It does not seem unreasonable then to hypothesize the elimination of all small arms weapons but one. Squads equipped only with Colt automatic rifles might then replace all machinegun squads and all squads using both rifles and automatic rifles.

Further, it is judged that the increased target effects of Colt automatic rifles over the rifle are due to the additional stability offered by the heavier barrel. If this is so, the newly developed XM148 grenade launcher attachment for use on the Colt rifle should provide the extra weight necessary to achieve a stability for the Colt rifle comparable to

Table 6-2 COMPARATIVE SCORES OF SPECIAL WEAPON MIXES

Mix	CET (Minutes)	Near Misses	Sustainability	Target Hits	Total Hits
(Rifle Situation 1 - No Comparable Machinegun Situations)					
Rifle Situation 2 - Machinegun Situation 3					
Top MG Mix	87.8	273.8	41.8	6.8	7.8
Top Rifle Mix	77.5	345.0	50.5	10.7	12.6
Average All Rifle Squad Mixes	80.9	283.7	23.8	9.1	9.6
All Colt AR Mix	79.9	426.0	38.6	10.8	10.8
(Rifle Situation 4 - No Comparable Machinegun Situation)					
Rifle Situation 5 - Machinegun Situation SA					
Top MG Mix	40.0	198.5	69.3	7.9	8.3
Top Rifle Mix	38.6	207.3	84.8	8.9	10.2
Average All Rifle Squad Mixes	40.6	141.5	63.1	6.5	6.9
All Colt AR Mix	38.1	268.8	34.7	8.8	10.3
(Machinegun Situation G - No Comparable Rifle Situations)					
Rifle Situation 7 - Machinegun Situation 9					
Top MG Mix	8.0	--	79.9	43.0	67.0
Top Rifle Mix	4.1	--	94.8	56.0	90.5
Average All Rifle Squad Mixes	5.6	--	69.1	50.5	76.7
All Colt AR Mix*	4.60	--	71.0	50.3	87.3

\* NOTE: Colt automatic rifle scores in this table are based on automatic fire. The best rifle mix in CET (4.1 min) in this situation was Mix CB (seven Colt rifles and two Colt automatic rifles) when the rifles were firing semiautomatic fire. In Series 1, when the same mix CB fired automatic fire, the CET was an unsatisfactory 5.98 minutes. If the Colt automatic rifle squads had fired semiautomatic, their expected score would have been less than 4 minutes, which is superior to all other mixes.

that of the Colt automatic rifle. The only disadvantage would be a shorter barrel life during sustained fire because of the rifle's lighter barrel. Thus, providing the Colt rifle with a SPIW-type dual "area fire-point fire" capability may, at the same time, provide the extremely desirable additional effect of providing added stability and better point fire target effects commensurate with those of the Colt automatic rifle and Stoner machinegun.

These fire effectiveness results and hypotheses warrant further testing. If these hypotheses are valid, their implications would be revolutionary. The cost effectiveness and associated logistic advantages of one weapon to replace the present rifle, automatic rifle, grenade launcher, and machinegun, are unquestionable.

Such a choice becomes more imperative if the one weapon, for example, Colt rifle with XM148 grenade launcher attachment) suggested to replace all other weapons has a proven fire superiority in every role over each of the weapons that it is proposed to replace--rifle, automatic rifle, machinegun, and M79 grenade launcher.

Within the current weapons inventory, the choice therefore, seems to become one of choosing among:

- 1) A squad equipped entirely with Colt automatic rifles
- 2) A squad equipped entirely with Colt rifles with XM148 grenade launchers
- 3) A squad equipped with a combination of Colt automatic rifles and separate grenade launchers (such as the M79)

The answer can come only through additional fire effectiveness experimentation. It should be dealt with in the IRUS study.



**C. MACHINEGUN SQUAD EXPERIMENT**

**1. Situation 3: Machinegun Squad in Fire Support of the Assault**

This situation evaluated machinegun squad weapon mixes firing supporting fire from hastily prepared foxholes at partially concealed and unconcealed targets in foxholes at a range of 269 to 326 meters. Machineguns of the squad were positioned 25 meters apart and fired at the same target array as in Situation 2.

Mixes firing in Situation 3 were UF (M60 tripod, T&E), UE (M60 bipod), SF (Stoner tripod T&E), SE (Stoner bipod), RF (Soviet DPM bipod), and RE (Soviet RPD bipod). The first five mixes were fired before Mix RE, which was not available at the time. Mix RF did not fire tracer ammunition the first time, and was fired again with tracer with the RE mix. Stoner Mixes SE and SF are not directly comparable to the other three mixes because of excessive misfires caused primarily by faulty ammunition (see Table 5-1).

Results for Situation 3 appear below, the first five squad firings first, followed by the later RE and RF firings.

Mix	CET	Near Misses	Percent Ammunition Remaining	Targets Hit	Total Hits
UF	87.79	273.8	41.8	6.8	7.8
UE	92.58	246.3	51.2	4.2	5.0
SF	94.09	139.3	84.7	3.4	4.0
SE	95.38	99.2	88.3	3.0	3.1
RF	96.03	109.2	70.5	3.3	3.8

Mix	CET	Near Misses	Percent Ammunition Remaining	Targets Hit	Total Hits
RE	92.87	246.6	51.2	5.8	6.0
RF	99.06	119.5	64.0	3.0	3.3

**2. Situation 5A: Machinegun Squad as a Base of Fire Supporting the Advance (375 to 560 meters)**

Machinegun squad mixes fired on two arrays of enemy targets from unprepared firing positions. Duration of fire was 4 minutes, with the first 2 minutes directed toward an array of 14 targets occupying an area 60 meters wide and 42 meters deep. The range from firers to

targets was 379 to 445 meters. The second 2 minutes of fire was delivered against an array of 13 targets occupying an area 45 meters wide and 62 meters deep, at ranges of 477 to 560 meters. The technique of fire employed was distributed fire throughout the sector, with point fire used when targets were seen or when weapon simulators gave specific cues to a target location. All firers had previously fired on these same arrays but from different positions. A summary of data is presented below.

Mix	CET	Near Misses	Percent Ammunition Remaining	Targets Hit	Total Hits
UF	40.03	198.5	69.29	7.92	8.30
UE	41.98	189.3	72.18	5.83	5.83
RE	42.25	120.0	89.52	5.10	6.10
SE	42.98	89.0	93.88	4.60	5.20
SF	44.13	107.3	91.80	3.17	3.67
RF	45.01	63.0	85.25	2.12	2.12

**3. Situation 6: Machinegun Squad in Fire Support of the Advance (446 to 753 meters)**

This situation evaluated machinegun squad weapon mixes against 40 targets with a programmed total target exposure time of 66.380 minutes. The targets were divided into three target arrays, X, Y, and Z. Ranges for Array X were from 603 to 646 meters, for Array Y from 690 to 753 meters, and Array Z from 446 to 488 meters. The programmed total target exposure time for Array X was 22.256 minutes (see Table B-21).

The machineguns firing Situation 6 were the same as those fired in Situation 3. Note that the Stoner machineguns had excessive stoppages (see Table 5-1) caused by faulty ammunition, and are therefore not directly comparable to the other mixes. Because of different firing conditions, the Soviet mixes (RE and RF) are also not directly comparable to the other machinegun mixes.

Mix	CET	Near Misses	Percent Ammunition Remaining	Targets Hit	Total Hits
UF	56.48	308.16	65.47	12.17	13.83
SF	63.07	183.17	89.86	6.00	7.00
UE	63.59	228.00	78.49	6.00	7.00
RE	64.49	133.20	93.41	6.40	6.80
SE	66.78	100.67	94.85	4.33	4.83
RF	68.82	50.75	82.61	2.25	1.26

#### 4. Situation 9: Machinegun Squad in Defense Against Attack

This situation evaluated the machinegun squad and mixes firing from hastily prepared foxholes at visible targets advancing from 345 to 45 meters. There were 50 targets, some of them appearing more than once. Their programmed total target exposure time was 15.976 minutes (see Table B-22 and Range B Sketch Map, Annex B.)

Mix	CET	Near Misses	Percent Ammunition Remaining	Targets Hits	Total Hits
UF	8.03	--	79.92	43.08	66.98
RF	8.59	--	82.33	40.37	57.23
SF	8.81	--	90.86	39.65	68.27
SE	8.94	--	95.24	38.92	59.78
UE	9.13	--	88.10	39.45	65.05

Mix	CET	Near Misses	Percent Ammunition Remaining	Targets Hit	Total Hits
RE	9.37	--	87.87	35.40	60.20
RF*	9.96	--	80.98	34.50	51.50

\* Second series for Mix RF

#### 5. Discussion

The M60 tripod mounted machinegun mix was consistently better than the M60 bipod mounted mix. The poor performance of the Stoner machinegun mixes, particularly in sustained fire (Situations 3 and 6), was caused by a high rate of misfires. The Stoner machinegun fired 20 percent less ammunition than the M60 although it has a higher rate of field fire. (See Section V, Materiel Reliability.) Gunners often had to recharge the Stoner weapons. This necessitated relaying and prevented effective adjustment of fire.

The Stoner machineguns did better in the day defense situation than in the other two situations. They ranked third and fourth behind the tripod mounted M60 and Soviet DPM and ahead of the bipod mounted M60 in CET. This situation, because it did not emphasize sustained fire, made fewer demands on mechanical reliability than did the base of fire situations. There were intervals between target appearances that sometimes allowed stoppages to be cleared, but firing time was still lost.

For these reasons, and because of a difference in time frame for the firing of the Soviet weapons, the experimentation results provide no basis for directly evaluating any of the experimentation machinegun types against one another in the machinegun role.

## SECTION VII

### DUPLEX AMMUNITION EXPERIMENT

#### A. RIFLE DUPLEX AMMUNITION EXPERIMENT

The US 7.62mm M14 rifle squad mixes (UA and UB) were fired in December 1965 and January 1966 in an experiment designed to compare the effectiveness of duplex ball ammunition and simplex ball ammunition for rifles.

Because the squads had already fired each situation during the earlier rifle experiment, they were generally familiar with the ranges; consequently, the duplex scores could not be compared directly with the earlier scores of the other 5.56mm and 7.62mm rifle mixes.

To allow an adjustment whereby the effects of squads firing duplex ammunition could be directly compared with other mixes, Mixes UA (nine M14 rifles) and UB (seven M14 rifles and two M14E2 automatic rifles) were divided. Three squads of each mix fired the duplex experiment, while a control group fired ball ammunition and the other three squads fired duplex ammunition. In both the duplex and ball ammunition squads, the firers in the two automatic rifle foxholes fired tracer and ball ammunition in the same modes of fire as in Series 1. Thus, the ammunition and firing modes for the two automatic rifle position remained constant for both duplex and ball ammunition squads for both mixes. Consequently, any differences in fire effectiveness can be attributed to the effects of the ball ammunition or duplex ammunition being used by the riflemen in the seven positions other than the automatic rifle positions (2 and 8 in Situation 1; 3 and 7 in Situations 2, 4, and 5; 4 and 7 in Situations 7 and 8).

By the use of control groups firing ball ammunition, the increase in scores as a result of learning and similar effects could be computed. Thus, the percentage of the increase in scores of squads firing duplex that was due to learning and the percentage that was due to duplex ammunition could be determined. These figures were then used to compute the score for the UA and UB mixes that would have been expected had the mixes fired duplex ammunition instead of ball ammunition their first time in each situation (Series 1). These adjusted scores ("expected" duplex scores) are directly comparable with the scores of other rifle mixes in the original rifle squad experiment.

The results are presented in two tables. Table 7-1 shows the raw scores of the duplex squads compared with the control squads firing ball ammunition for each of the six rifle squad situations. Probability

**Table 7-1  
RAW SCORE RESULTS  
(Rifle Duplex Experiment)**

Effectiveness Measures	Duplex		Ball		t	p
	$\bar{X}$	SD	$\bar{X}$	SD		
<b>Situation 1 - Rifle Squad in Line Assault</b>						
CET (min.)	21.66	2.06	21.52	3.27	0.090	> 0.400
Near Misses	680.00	44.20	399.83	71.25	8.186	< .001
Sustainability	65.10	5.64	61.42	5.60	1.135	.142
Targets Hit	7.31	2.81	7.66	2.26	0.239	> .400
Total Hits	8.33	2.69	8.46	2.44	0.090	> .400
<b>Situation 2 - Rifle Squad as Base of Fire Supporting the Assault</b>						
CET (min.)	74.03	8.64	80.50	6.27	1.372	.103
Near Misses	412.20	93.29	308.00	44.33	2.470	.018
Sustainability	14.57	8.64	15.58	5.47	0.226	> .400
Targets Hit	13.50	3.39	11.25	2.22	1.269	.124
Total Hits	15.17	3.76	12.00	2.94	1.488	.090
<b>Situation 4 - Rifle Squad in Approach to Contact</b>						
CET (min.)	1.78	0.054	1.87	0.26	0.827	.216
Near Misses	--	--	--	--	--	--
Sustainability	59.05	9.87	69.58	7.43	2.088	.034
Targets Hit	31.83	2.48	32.17	3.06	0.211	> .40
Total Hits	78.67	8.31	48.50	11.15	5.314	< 0.001

**Table 7-1**  
**RAW SCORE RESULTS**  
**(Rifle Duplex Experiment) (Concluded)**

Effectiveness Measures	Duplex		Ball		t	p
	$\bar{X}$	SD	$\bar{X}$	SD		
<b>Situation 5 - Rifle Squad as Base of Fire Supporting the Advance</b>						
CET (min.)	37.88	3.99	39.14	4.61	0.506	0.313
Near Misses	229.33	76.15	138.33	67.75	2.187	.027
Sustainability	46.83	9.03	52.37	6.20	1.239	.124
Targets Hit	7.33	2.25	7.67	2.66	0.239	>.400
Total Hits	9.50	4.09	8.17	3.19	0.628	.273
<b>Situation 7 - Rifle Squad in Defense Against Attack</b>						
CET (min.)	4.35	0.7	4.40	1.1	0.12	>.40
Near Misses	--	--	--	--	--	--
Sustainability	43.2	13.0	50.5	12.5	1.21	.12
Targets Hit	53.0	2.1	52.7	2.3	0.29	.39
Total Hits	114.3	10.4	91.1	11.5	4.49	.0005
<b>Situation 8 - Rifle Squad in Night Defense</b>						
CET (min.)	6.33	0.3	6.78	0.2	3.7	.002
Near Misses	--	--	--	--	--	--
Sustainability	19.4	3.5	27.1	12.5	1.8	.04
Targets Hit	17.6	3.4	17.0	2.9	0.4	.35
Total Hits	39.0	12.3	30.9	7.9	1.7	0.07

values (p) have been computed, using a two-sample t-statistic (see Section III, page 3-3, for an explanation of probability values).

Table 7-2 shows the expected duplex scores. These are the scores that would have been expected if the rifle squads had fired duplex instead of ball ammunition in this first firing of the various situations. The first firing scores were adjusted by applying mathematical corrections derived from the first firing scores of the original rifle squad experiment and the duplex experiment firing scores of all six squads of each mix. The scores are directly comparable and represent the contributions of all six squads of each mix. The scores in each case represent the average score of Mix UA and UB combined.

Duplex ammunition provides an advantage in near misses in the assault (125 to 15 meters). An advantage would then also be expected to accrue on the number of concealed undetected targets hit; however, in terms of hits and total number of hits on detected targets, there is no improvement evident as a result of firing duplex in the assault situation (Figures 7-1 and 7-2).

In the approach to contact situation (Pointing Fire, 15 to 163 meters), there are no tactically significant differences between duplex and ball ammunition, except for the total number of hits on targets that were hit. No more targets were hit by using duplex, but when a target was hit by a squad using duplex, it was hit with an average of 2.5 to 3 bullets (Figure 7-3).

In the longer range supporting fire of Situation 5 (390 to 545 meters), duplex ammunition provided a significant increase in the number of near misses and possibly a small increase in the total number of hits on targets that were hit. There was no increase in the number of targets hit. However, in the shorter range supporting fires of Situation 2 (300 meters), duplex ammunition resulted in increases in all target effects (CET, near misses, number of targets hit, and total number of hits) (Figures 7-4 through 7-7).

In Situations 7 and 8, aimed fire against visible point targets (45 to 320 meters), duplex ammunition provided a clear superiority in the total number of hits on targets that were hit. Although a small numerical advantage in the number of targets hit accrued in this situation, the large variability in squad scores indicates this difference is the result of chance variations (Table 7-1). See Figures 7-8 and 7-9 for cumulative exposure time by range and target.

In five of the six rifle situations, the number of rounds fired by the squads using duplex ammunition was greater than for the squads using ball ammunition. The reason cannot be explained. Since both groups had equal experience on the range, equal training, and equal weapons, it was hypothesized that both would fire the same amount of ammunition. This result merits further investigations.



**Table 7-2  
EXPECTED DUPLEX SCORE  
(Rifle Duplex Experiment)**

<b>Effectiveness Measures</b>	<b>Original Ball Ammunition Score (UA and UB)</b>	<b>Expected Duplex Score</b>
<b>Situation 1 - Rifle Squad in Line Assault</b>		
CET (min.)	24.8	26.3
Near Misses	314.2	448.0
Sustainability	46.4	59.7
Targets Hit	4.5	3.8
Total Hits	4.6	4.0
<b>Situation 2 - Rifle Squad as Base of Fire Supporting the Assault</b>		
CET (min.)	78.8	72.4
Near Misses	285.5	382.6
Sustainability	16.2	17.0
Targets Hit	10.4	14.2
Total Hits	11.5	18.1
<b>Situation 4 - Rifle Squad in Approach to Contact</b>		
CET (min.)	2.05	2.01
Near Misses	--	--
Sustainability	75.2	62.1
Targets Hit	30.4	27.9
Total Hits	47.1	83.1

**Table 7-2**  
**EXPECTED DUPLEX SCORE**  
**(Rifle Duplex Experiment) (Concluded)**

Effectiveness Measures	Original Ball Ammunition Score (UA and UB)	Expected Duplex Score
<b>Situation 5 - Rifle Squad as Base of Fire Supporting the Advance</b>		
CET (min.)	41.4	41.0
Near Misses	118.3	179.7
Sustainability	57.4	51.0
Targets Hit	5.7	6.7
Total Hits	5.7	6.7
<b>Situation 7 - Rifle Squad in Defense Against Attack</b>		
CET (min.)	5.9	5.6
Near Misses	--	--
Sustainability	61.3	51.3
Targets Hit	48.3	48.6
Total Hits	71.3	96.3
<b>Situation 8 - Rifle Squad in Night Defense</b>		
CET (min.)	6.8	6.4
Near Misses	--	--
Sustainability	44.9	36.3
Targets Hit	20.6	20.8
Total Hits	25.6	30.9

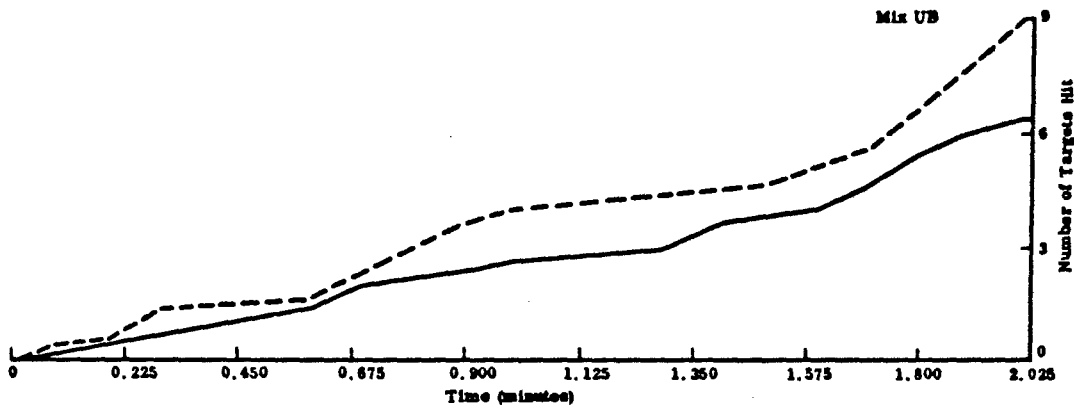
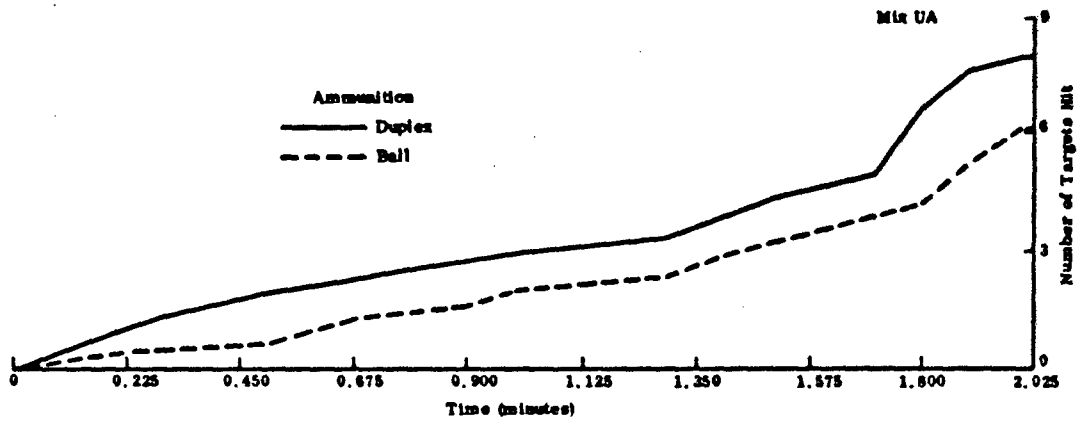

Figure 7-1  
CUMULATIVE NUMBER OF TARGETS HIT--SITUATION 1

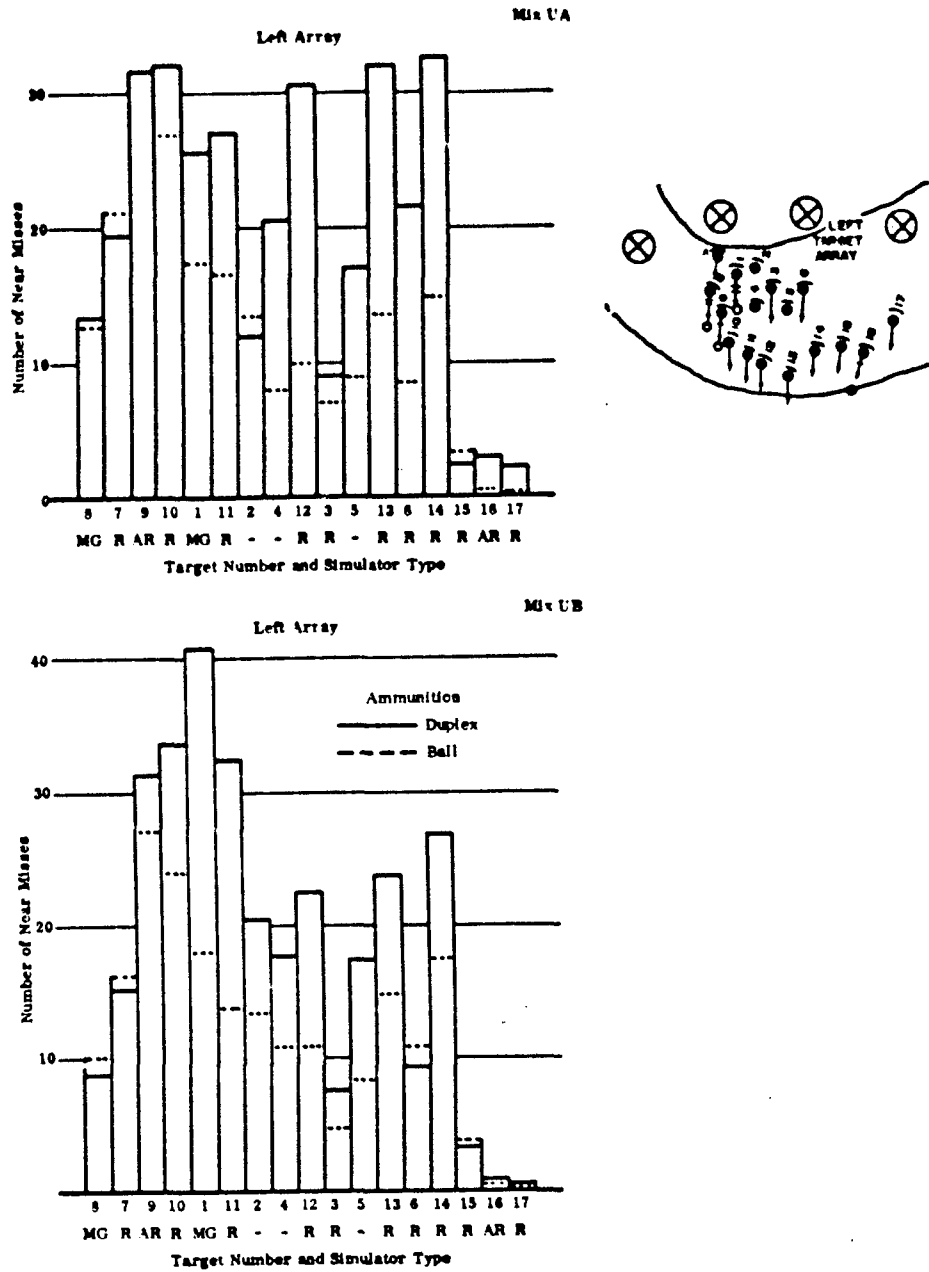

Figure 7-2  
 NUMBER AND DISTRIBUTION OF NEAR MISSES--  
 SITUATION 1

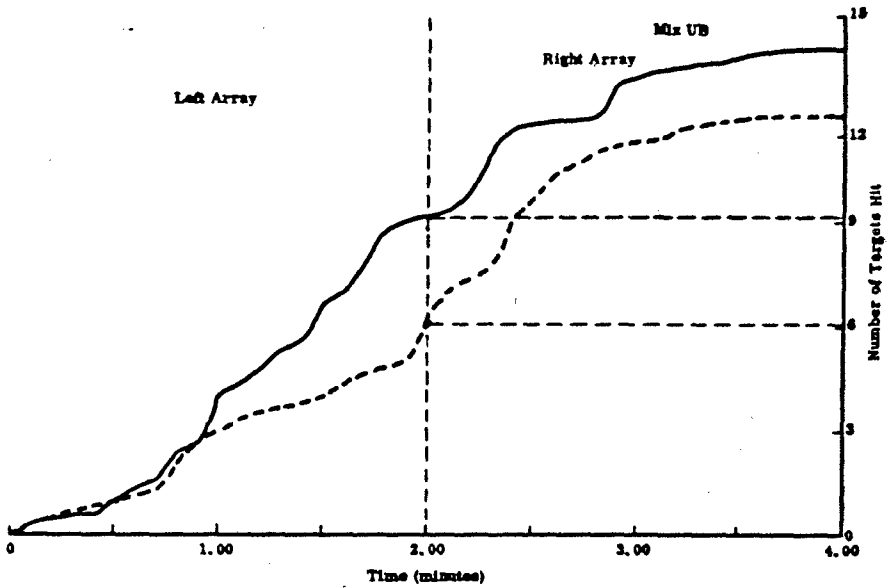
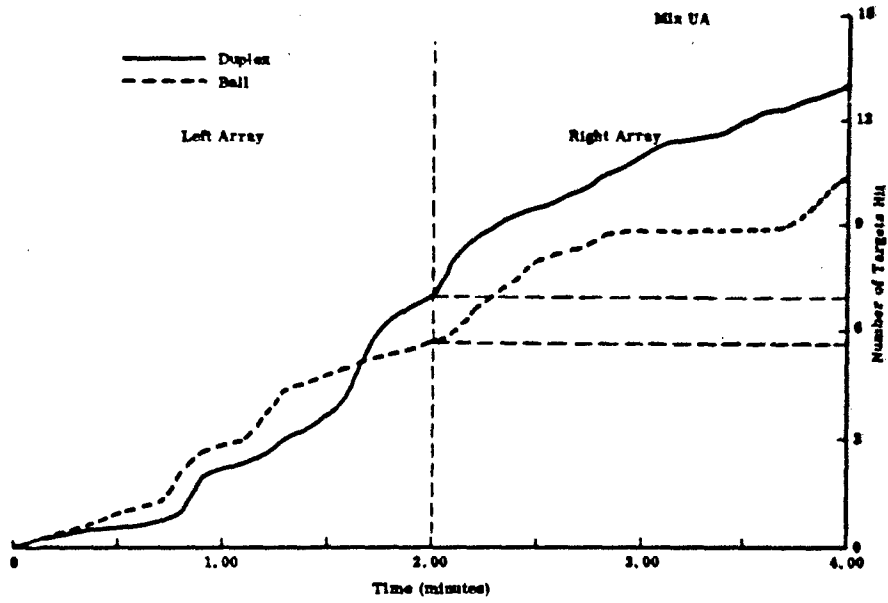

Figure 7-3  
CUMULATIVE NUMBER OF TARGETS HIT--SITUATION 2

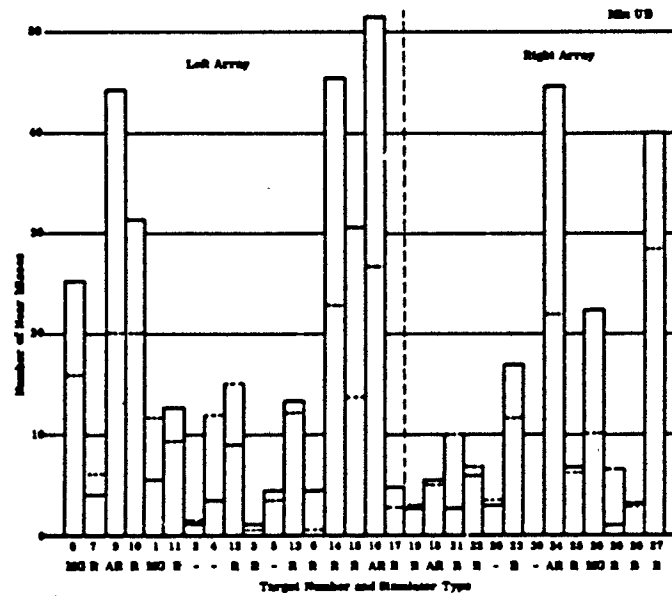
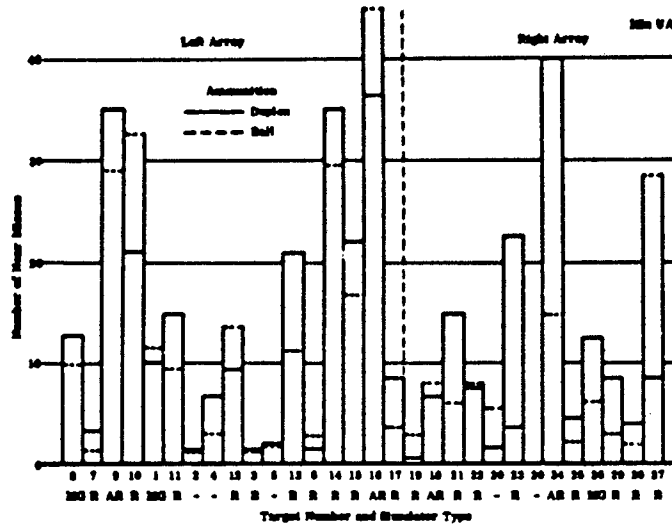
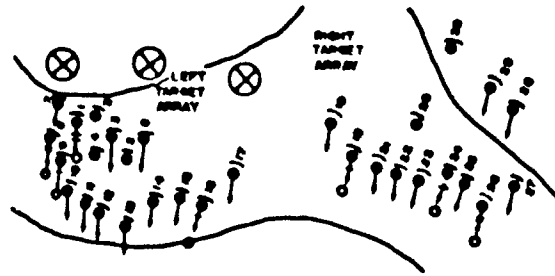

Figure 7-4 NUMBER AND DISTRIBUTION OF NEAR MISSES--SITUATION 2

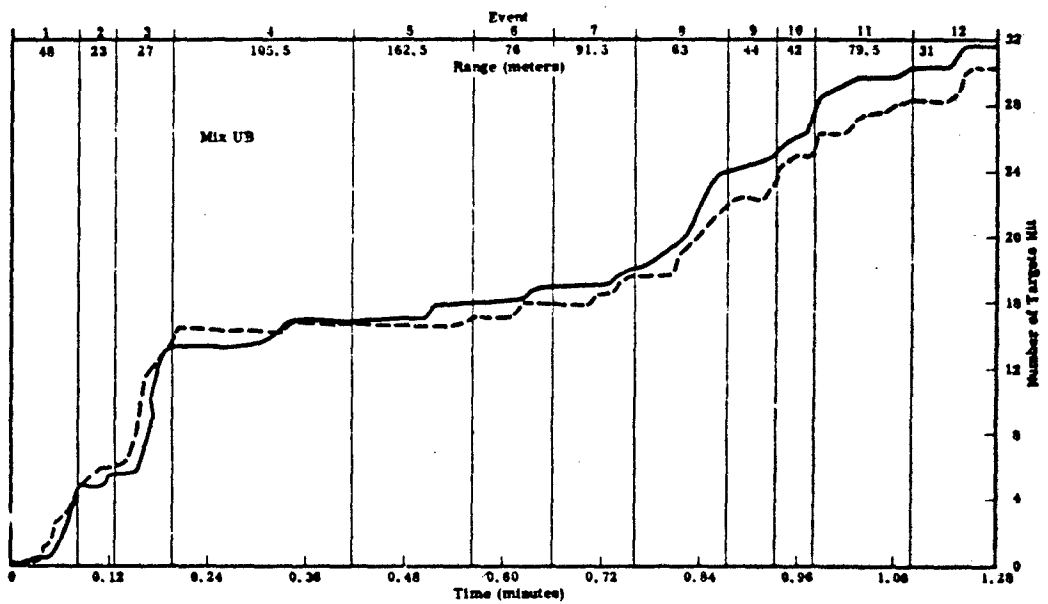
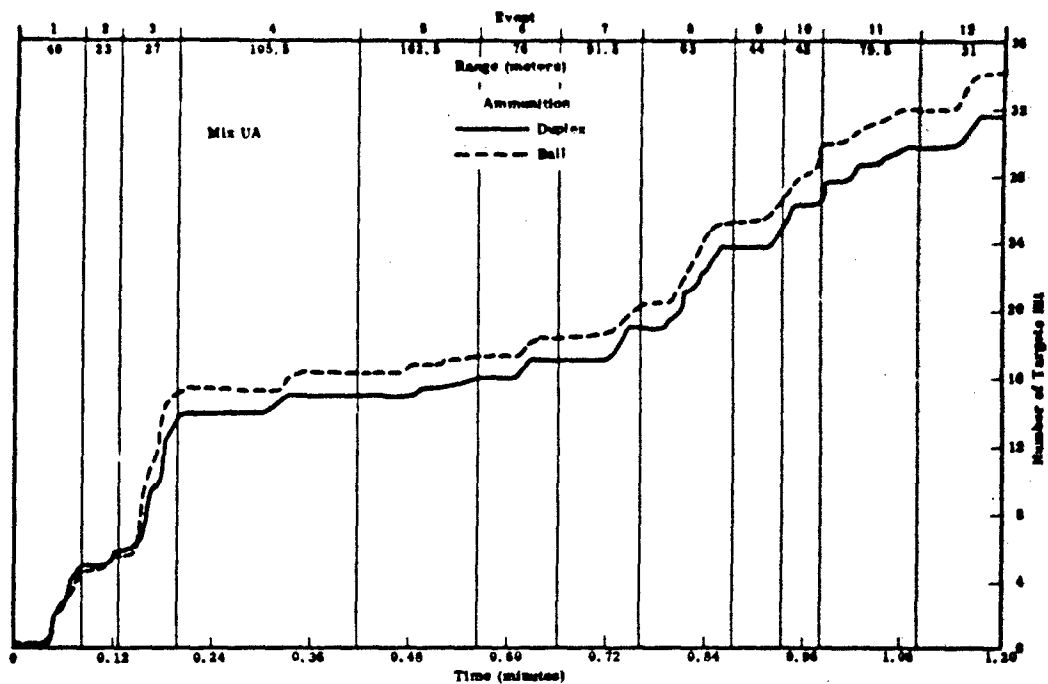

Figure 7-5  
 CUMULATIVE NUMBER OF TARGETS HIT--SITUATION 4

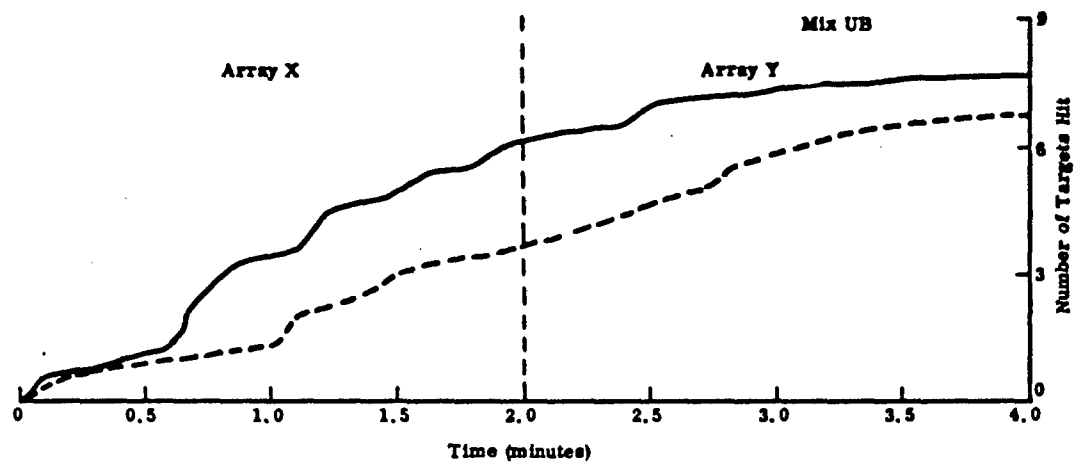
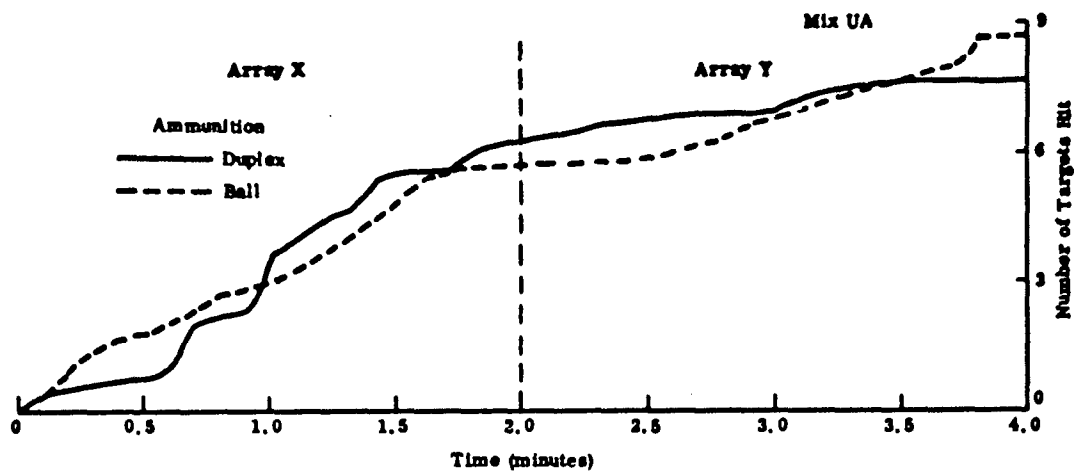
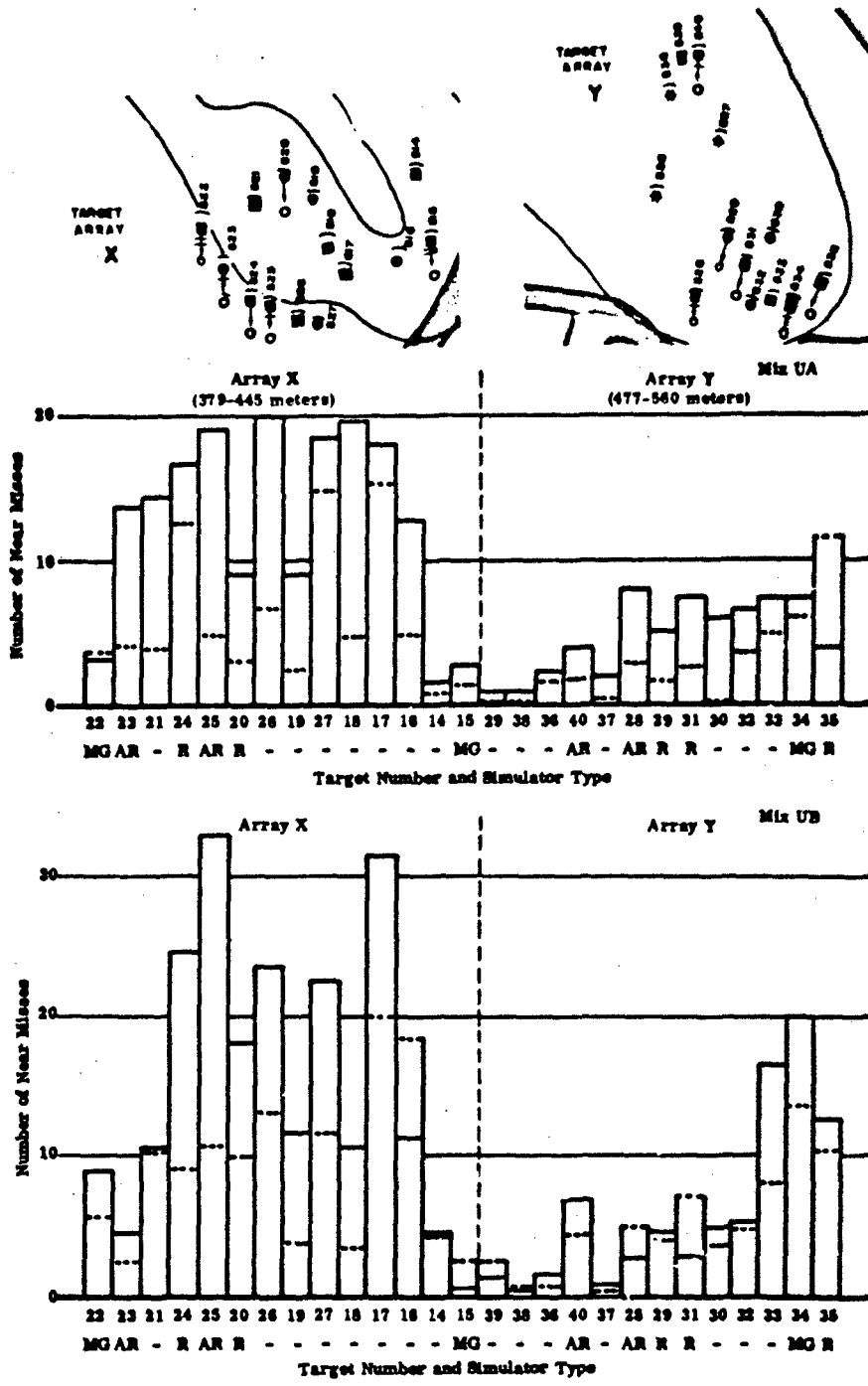

Figure 7-6  
CUMULATIVE NUMBER OF TARGETS HIT--SITUATION 5





**Figure 7-7**  
**NUMBER AND DISTRIBUTION OF NEAR MISSES--**  
**SITUATION 5**

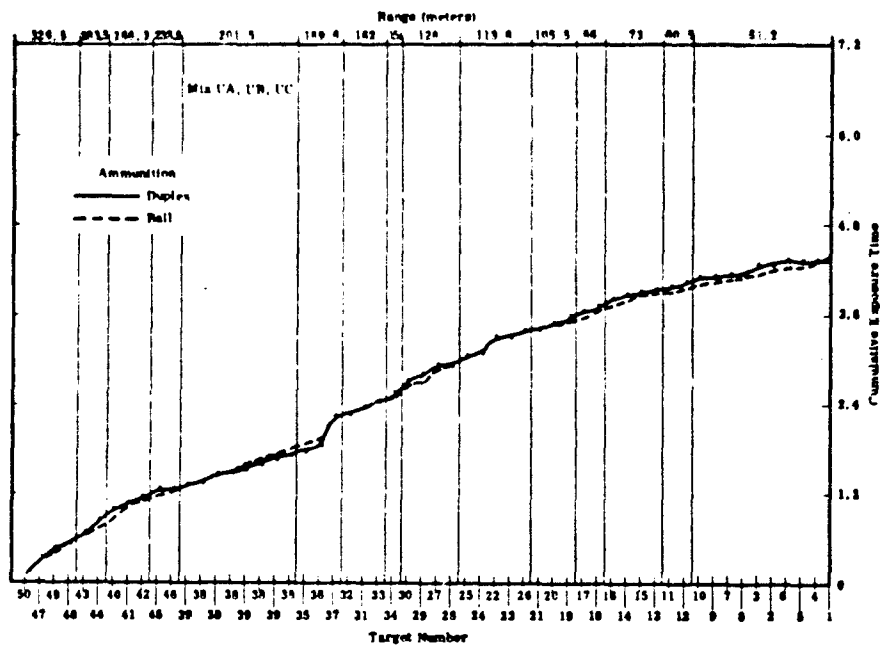

Figure 7-8 CUMULATIVE EXPOSURE TIME--SITUATION 7

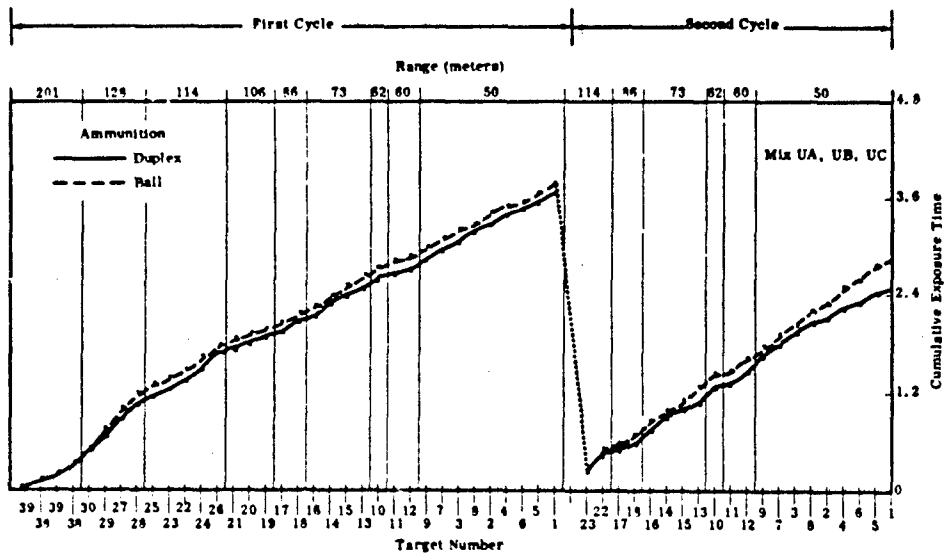

Figure 7-9 CUMULATIVE EXPOSURE TIME--SITUATION 8

It would be expected that as more duplex rounds were fired, an increase in target effects would be achieved, even if duplex had not been used. This could have been expected as a result of the greater number of rounds fired; however, although that might have accounted for the increases in the number of targets hit and the lower CETs, it was not great enough to account for the consistent superiority in both number of near misses and the total number of hits per target.

The use of duplex ammunition cannot be considered detrimental when used with the rifle in any situation at ranges between 15 and 545 meters. Moreover, duplex provided marked advantages under some circumstances, particularly in the area of number of near misses as an index of suppressive effect and distribution of fire. Within the framework of the USACDCEC experiment, it is concluded that duplex ammunition does not significantly decrease effectiveness under any circumstances, and under some circumstances, it increases effectiveness.

In Table 7-3, the expected duplex scores for the M14 rifle squads (UA and UB) are compared to the top ranking mix in each of the six rifle situations. The better score in each case is indicated by an asterisk.

The concept of duplex ammunition applies equally to both 7.62mm and 5.56mm ammunition. The increase in target effects achieved with 7.62mm duplex ammunition cannot be interpreted as a rationale for a choice of 7.62mm weapons over 5.56mm. Any advantages accruing to 7.62mm weapons from the use of duplex must also be attributed to 5.56mm weapons with duplex. Although not specifically tested in the experiment, 5.56mm duplex ammunition has been satisfactorily produced and tested in earlier laboratory and field experimentation by the Operations Research Office.<sup>1</sup> This ammunition weighs only about half that of 7.62mm duplex ammunition. Because current 5.56mm weapons are also lighter than 7.62mm weapons, an additional weight advantage is obtained. This combined weight advantage allows the soldier to carry up to three times as much 5.56mm ball ammunition as 7.62mm duplex ammunition for the same rifle system weight (Colt rifle versus M14).

Analysis shows that although the effects per round of ammunition are greater for 7.62mm duplex than for 5.56mm ball ammunition under certain circumstances, the effects per pound of ammunition are always significantly greater for 5.56mm ball than for 7.62mm duplex. Although duplex ammunition provided some advantages, greater advantages are considered possible, for it is believed that the duplex ammunition provided to USACDCEC did not meet all military ammunition requirement standards and that better quality control could have been exercised.

<sup>1</sup> Operations Research Office, SALVO II Rifle Experiment Preliminary Results (U), Johns Hopkins University, March 1958. CONFIDENTIAL

**Table 7-3  
 EXPECTED DUPLEX SCORES COMPARED WITH  
 TOP RANKED RIFLE MIXES  
 (Rifle Duplex Experiment)**

Effectiveness Measures	Best Mix and Raw Score (first firing)	UA Expected Duplex Score	UB Expected Duplex Score
<b>Situation 1 - Rifle Squad in Live Assault</b>			
CET (min.)	UB 24.1*	27.0	25.6
Near Misses	SC 499.6*	438.0	458.0
Sustainability	CA 72.2*	61.2	58.2
Targets Hit	UB 5.1*	3.4	4.4
Total Hits	SB 5.2*	3.5	4.5
<b>Situation 2 - Rifle Squad as Base of Fire Supporting the Assault</b>			
CET (min.)	UA 77.5	72.0*	72.8
Near Misses	CB 345.0	345.0	420.2*
Sustainability	CA 50.5*	23.0	13.0
Targets Hit	UA 10.7	14.4*	14.0
Total Hits	UA 12.6	19.8*	16.4
<b>Situation 4 - Rifle Squad in Approach to Contact</b>			
CET (min.)	SC 1.95*	1.99	2.03
Near Misses	-- --	--	--
Sustainability	CB 80.8*	65.1	59.1
Targets Hit	SC 30.8*	27.5	28.3
Total Hits	SC 53.8	87.1*	79.1

\* Better score

Note: Although Mix UB was in first place in Situation 1 in CET and Targets Hit when using ball ammunition, its expected duplex scores result in a drop to 7th and 4th place, respectively.

**Table 7-3**  
**EXPECTED DUPLEX SCORES COMPARED WITH**  
**TOP RANKED RIFLE MIXES**  
**(Rifle Duplex Experiment) (Concluded)**

Effectiveness Measures	Best Mix and Raw Score (first firing)	UA Expected Duplex Score	UB Expected Duplex Score
<b>Situation 5 - Rifle Squad as Base of Fire Supporting the Advance</b>			
CET (min.)	CB 38.6*	40.0	42.0
Near Misses	SA 207.3	207.5*	151.9
Sustainability	CA 84.8*	52.5	49.5
Targets Hit	SA 8.9*	7.6	5.8
Total Hits	SA 10.2*	7.6	5.8
<b>Situation 7 - Rifle Squad in Defense Against Attack</b>			
CET (min.)	CB 4.15*	5.0	6.2
Near Misses	-- --	--	--
Sustainability	CB 94.8*	61.5	41.1
Targets Hit	SB 56.0*	49.0	48.2
Total Hits	CB 90.5	92.0	100.6*
<b>Situation 8 - Rifle Squad in Night Defense</b>			
CET (min.)	SB 6.0	6.4	6.0
Near Misses	-- --	--	--
Sustainability	CB 69.4*	35.3	37.3
Targets Hit	CB 25.5*	18.3	22.3
Total Hits	SC 38.0*	29.0	32.8

Further immediate experimentation with duplex ammunition, particularly 5.56mm, is considered necessary.

#### B. AUTOMATIC RIFLE DUPLEX AMMUNITION EXPERIMENT

Mix UD (nine M14E2 rifles) was also fired in the duplex experiment. Three squads of the mix fired duplex ammunition and the other three fired ball as a control. All weapons fired two-round bursts, and the weapons in the automatic rifle positions (2 and 8 in Situation 1; 3 and 7 in Situations 2, 4 and 5; 4 and 7 in Situations 7 and 8) fired a mixture of half tracer and half ball ammunition in both the duplex squads and control squads. Results, presented in the same format as for the rifle duplex experiment, are given in tables for raw scores and expected scores (Tables 7-4 and 7-5).

Duplex provided a marked advantage in the assault and approach to contact -- (the two moving situations when the weapon was fired in shoulder pointed unaimed fire). In Situation 7 (aimed fire at point targets) duplex provided a tactically significant increase in the number of hits on targets that were hit. Although duplex provided an advantage in some situations, the numerical results of the firing in other situations (for example, Situation 5) indicated that ball ammunition is superior in automatic fire at longer ranges. The sample size, however, was small (three squads per group), and the variability of performance great. These differences may have occurred as the result of such chance factors as weather (Figures 7-10 through 7-12).

#### C. M60 MACHINEGUN DUPLEX AMMUNITION EXPERIMENT

The M60 bipod and tripod machinegun mixes that had originally fired during the September-December 1965 experimentation period fired each of the three machinegun situations again in January 1966. At that time, half of each mix fired ball ammunition and the other half duplex. Both halves used a mixture of one tracer to four rounds of nontracer ammunition.

Results are presented below in two tables. Table 7-6 presents the raw scores of the duplex squad compared to the control squads firing ball ammunition. Scores are given for squads using bipod machineguns (UE) and squads using tripod machineguns (UF) for each of the three machinegun situations (Situation 3, fire support of the assault; Situation 6, fire support of the advance; Situation 9, defense against attack). These raw scores represent small sample sizes (three squads) and the scores obtained after having already fired the various situations previously. To reduce the effects of inherent squad variabilities and put the scores in a format that would give the best estimate of what scores would have been obtained by all squads of the mixes if they had fired duplex instead of ball on their first firing in each situation, the scores were mathematically adjusted to eliminate the effects of learning and squad proficiency

**Table 7-4**  
**RAW SCORE RESULTS**  
**(Automatic Rifle Duplex Experiment)**

Effectiveness Measures	Ammunition				t	p
	Duplex		Ball			
	$\bar{X}$	SD	$\bar{X}$	SD		
<b>Situation 1 - Rifle Squad in Line Assault</b>						
CET (min.)	24.73	2.12	26.07	0.60	1.06	0.18
Near Misses	562.67	53.38	288.00	95.14	4.36	.006
Sustainability	72.67	6.27	65.93	4.06	1.56	.10
Targets Hit	5.29	0.64	2.83	1.93	2.10	.05
Total Hits	5.66	1.28	2.83	1.93	2.12	.05
<b>Situation 2 - Rifle Squad as Base of Fire Supporting the Assault</b>						
CET (min.)	77.06	1.01	82.09	6.43	1.34	.13
Near Misses	258.3	36.68	250.17	13.01	0.34	.38
Sustainability	7.23	7.07	11.73	7.80	0.74	.23
Targets Hit	11.33	1.15	9.33	2.31	1.34	.13
Total Hits	11.33	1.15	9.33	2.31	1.34	.13
<b>Situation 4 - Rifle Squad in Approach to Contact</b>						
CET (min.)	1.82	0.093	1.87	0.11	0.62	.29
Near Misses	--	--	--	--	--	--
Sustainability	21.10	24.13	20.40	27.0	.03	> .40
Targets Hit	33.33	1.15	30.33	1.5	2.71	.03
Total Hits	69.00	6.24	43.67	1.2	6.91	.002

**Table 7-4**  
**RAW SCORE RESULTS**  
**(Automatic Rifle Duplex Experiment) (Concluded)**

Effectiveness Measures	Ammunition				t	p
	Duplex		Ball			
	$\bar{X}$	SD	$\bar{X}$	SD		
<b>Situation 5 - Rifle Squad as a Base of Fire Supporting the Advance</b>						
CET (min.)	38.50	8.44	37.80	2.6	0.137	> .40
Near Misses	141.67	107.39	173.33	40.8	0.477	.33
Sustainability	47.60	4.16	56.57	6.8	1.949	.07
Targets Hit	7.33	4.58	7.67	4.2	0.467	.33
Total Hits	7.33	5.13	8.67	4.2	0.351	.37
<b>Situation 7 - Rifle Squad in Defense Against Attack</b>						
CET (min.)	5.2	1.1	5.3	.4	.37	.37
Near Misses	--	--	--	--	--	--
Sustainability	65.6	1.0	61.0	5.5	1.44	.11
Targets Hit	50.8	2.4	48.7	4.2	.78	.21
Total Hits	99.8	12.8	77.8	3.5	2.86	.02
<b>Situation 8 - Rifle Squad in Night Defense Against Attack</b>						
CET (min.)	6.6	.34	6.73	.59	.37	.37
Near Misses	--	--	--	--	--	--
Sustainability	1.0	1.7	4.0	3.6	1.30	.13
Targets Hit	14.7	1.5	15.0	3.0	.17	> .40
Total Hits	30.3	4.9	27.7	6.8	.55	0.31



**Table 7-5  
EXPECTED DUPLEX SCORES  
(Automatic Rifle Duplex Experiment)**

<b>Effectiveness Measures</b>	<b>Original Ball Ammunition Score (UD)</b>	<b>Expected Duplex Score</b>
<b>Situation 1 - Rifle Squad in Live Assault</b>		
CET (min.)	25.5	22.5
Near Misses	203.3	402.5
Sustainability	43.4	59.4
Targets Hit	2.9	7.5
Total Hits	2.9	7.5
<b>Situation 2 - Rifle Squad as Base of Fire Supporting the Assault</b>		
CET (min.)	78.6	75.4
Near Misses	272.0	227.1
Sustainability	7.8	25.9
Targets Hit	8.8	7.6
Total Hits	9.5	7.8
<b>Situation 4 - Rifle Squad in Approach to Contact</b>		
CET (min.)	2.1	1.9
Near Misses	--	--
Sustainability	42.0	46.2
Targets Hit	27.8	34.9
Total Hits	38.6	76.3

**Table 7-5**  
**EXPECTED DUPLEX SCORES**  
 (Automatic Rifle Duplex Experiment) (Concluded)

<b>Effectiveness Measures</b>	<b>Original Ball Ammunition Score (UD)</b>	<b>Expected Duplex Score</b>
<b>Situation 5 - Rifle Squad as Base of Fire Supporting the Advance</b>		
CET (min.)	40.3	43.7
Near Misses	125.5	83.5
Sustainability	52.1	43.8
Targets Hit	6.5	4.2
Total Hits	6.7	4.2
<b>Situation 7 - Rifle Squad in Defense Against Attack</b>		
CET (min.)	6.8	8.0
Near Misses	--	--
Sustainability	43.1	37.5
Targets Hit	44.9	42.7
Total Hits	70.2	80.9
<b>Situation 8 - Rifle Squad in Night Defense Against Attack</b>		
CET (min.)	7.6	7.8
Near Misses	--	--
Sustainability	38.1	32.1
Targets Hit	15.3	8.3
Total Hits	19.2	16.7

Table 7-6  
 RAW SCORE RESULTS  
 (Machinegun Duplex Experiment)

Effectiveness Measures	Ammunition				t	p
	Duplex		Ball			
	$\bar{X}$	SD	$\bar{X}$	SD		
<b>Situation 3 - Fire Support of Assault Mix UE, M60 Bipod Machinegun</b>						
CET (min.)	80.90	6.40	94.36	3.07	3.284	.017
Near Misses	352.0	53.36	249.7	36.12	2.751	.026
Sustainability	41.45	8.09	50.70	17.45	0.833	.227
Targets Hit	9.33	0.579	4.67	2.08	3.738	.010
Total Hits	10.67	0.579	4.67	2.08	4.813	.005
<b>Mix UF, M60 Tripod Machinegun (with T&amp;E mechanism)</b>						
CET (min.)	83.79	4.50	95.42	5.73	2.765	.025
Near Misses	371.3	78.47	324.3	51.21	0.864	.218
Sustainability	50.20	13.50	27.16	7.39	2.593	.032
Targets Hit	9.67	3.11	3.67	2.08	2.778	.025
Total Hits	12.33	2.58	4.33	3.21	3.365	.016
<b>Situation 6 - Fire Support of the Advance Mix UE - M60 Bipod Machinegun</b>						
CET (min.)	58.67	2.00	59.69	5.30	0.311	.387
Near Misses	307.33	68.30	270.33	102.08	0.522	.316
Sustainability	69.43	15.06	65.93	12.47	0.310	.387
Targets Hit	11.67	3.79	10.35	3.06	0.475	.332
Total Hits	12.33	4.04	12.33	3.06	0.000	>.40

**Table 7-6  
RAW SCORE RESULTS  
(Machinegun Duplex Experiment) (Concluded)**

Effectiveness Measures	Ammunition				t	p
	Duplex		Ball			
	$\bar{X}$	SD	$\bar{X}$	SD		
<b>Situation 6 - Mix UF, M60 Tripod Machinegun (no T&amp;E mechanism)</b>						
CET (min.)	62.94	2.11	59.77	1.72	2.018	.060
Near Misses	240.67	48.81	325.33	94.32	1.381	.122
Sustainability	66.83	1.45	60.20	10.25	1.110	.166
Targets Hit	6.00	3.00	13.33	4.93	2.20	.047
Total Hits	6.67	2.52	14.67	7.23	1.809	.027
<b>Situation 9 - Defense Against Attack Mix UE, M60 Bipod Machinegun</b>						
CET (min.)	8.36	1.24	8.75	1.22	0.388	.361
Near Misses	--	--	--	--	--	--
Sustainability	79.8	2.79	88.6	1.74	4.635	.005
Targets Hit	42.33	1.39	38.67	5.51	1.116	.165
Total Hits	83.67	6.11	61.33	14.47	2.463	.037
<b>Mix UF, M60 Tripod Machinegun (no T&amp;E mechanism)</b>						
CET (min.)	7.52	0.51	7.45	0.35	0.196	>.400
Near Misses	--	--	--	--	--	--
Sustainability	79.2	4.31	84.2	3.44	1.570	.097
Targets Hit	43.00	1.00	45.00	3.46	0.962	.196
Total Hits	91.33	13.58	63.67	8.39	3.002	.022

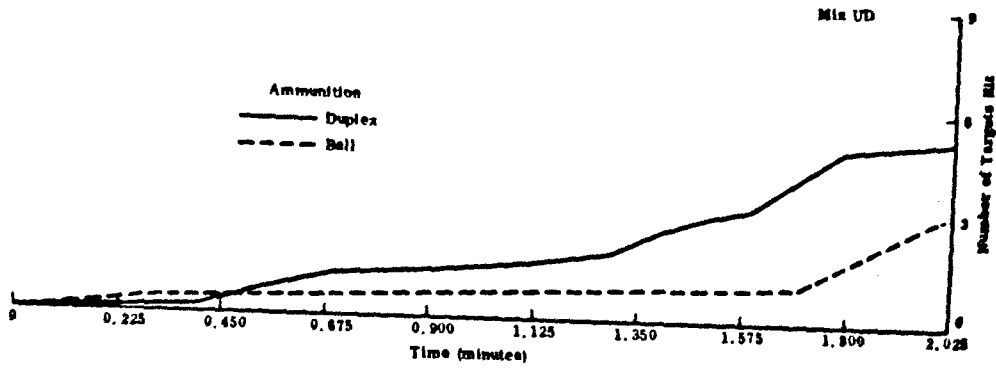

Situation 1

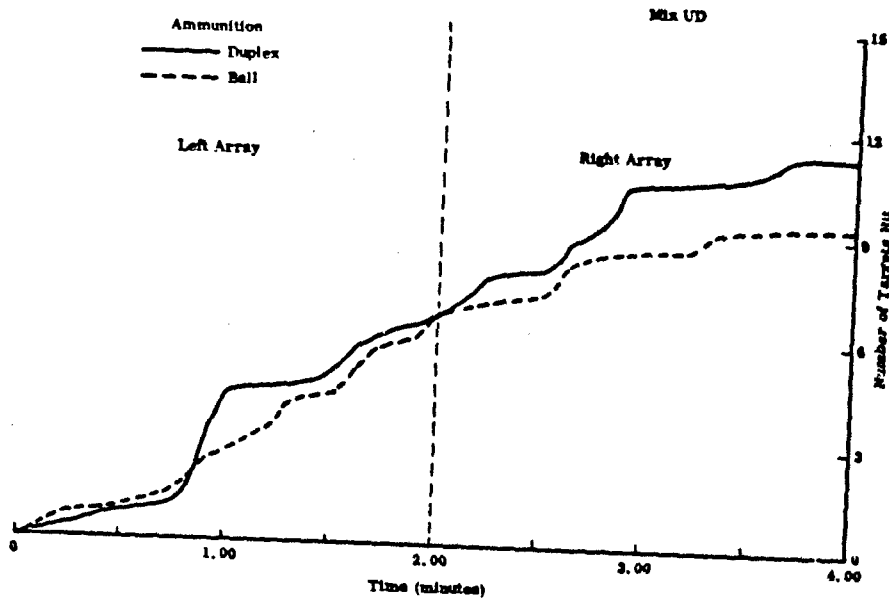

Situation 2

Figure 7-10 CUMULATIVE NUMBER OF TARGETS HIT

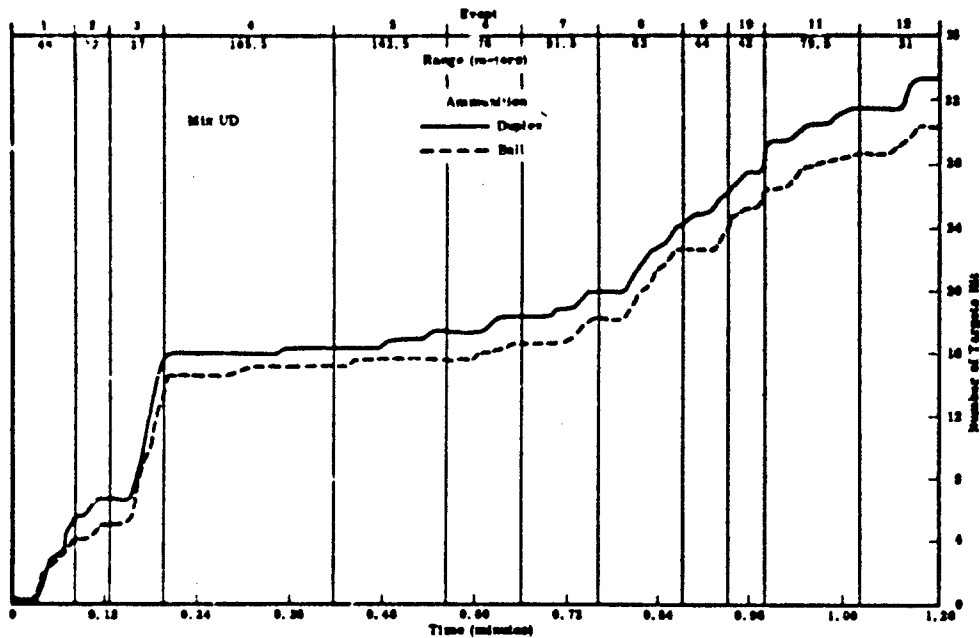

Situation 4

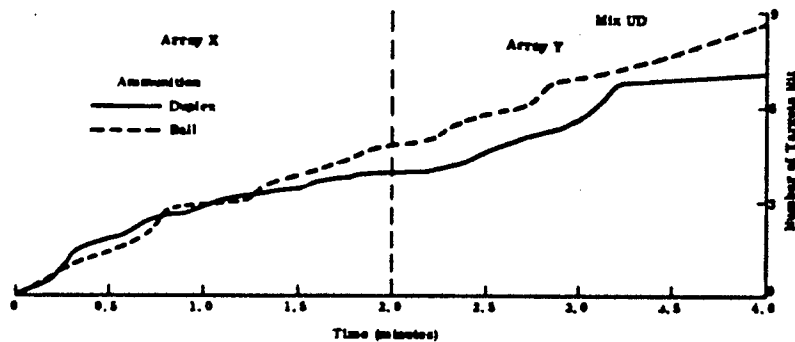

Situation 5

Figure 7-10 (Concluded)  
 CUMULATIVE NUMBER OF TARGETS HIT

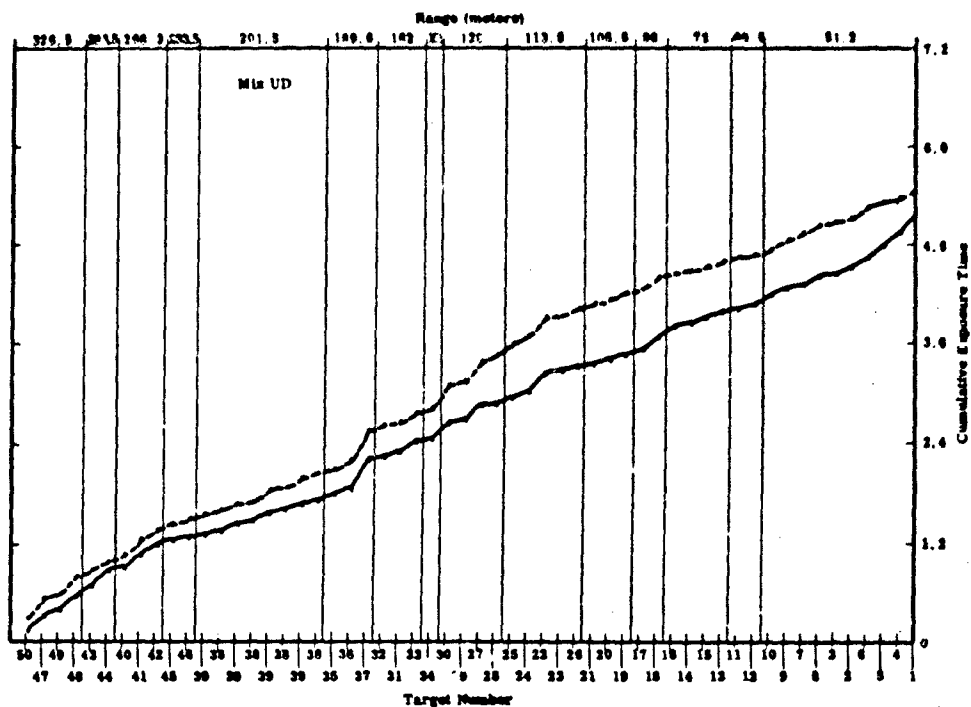

Situation 7

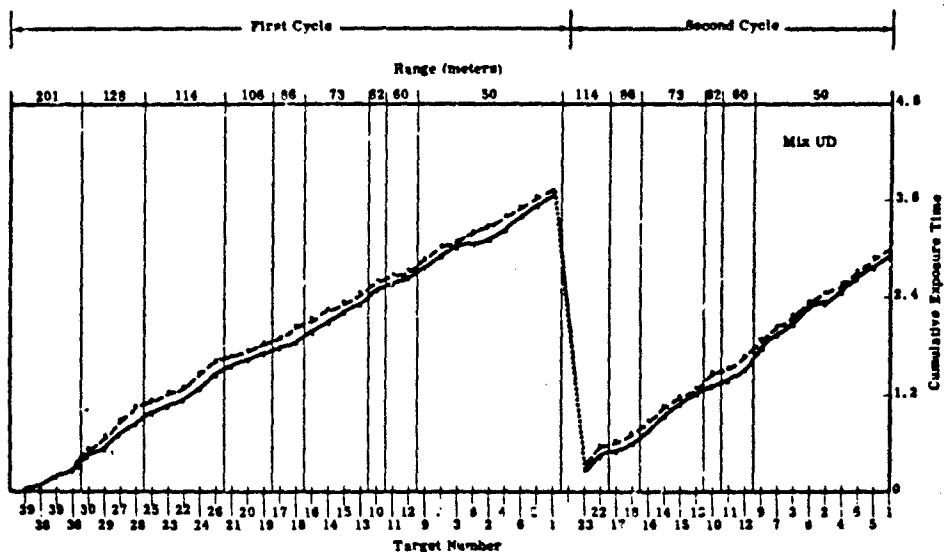

Situation 8

Figure 7-11 CUMULATIVE EXPOSURE TIME

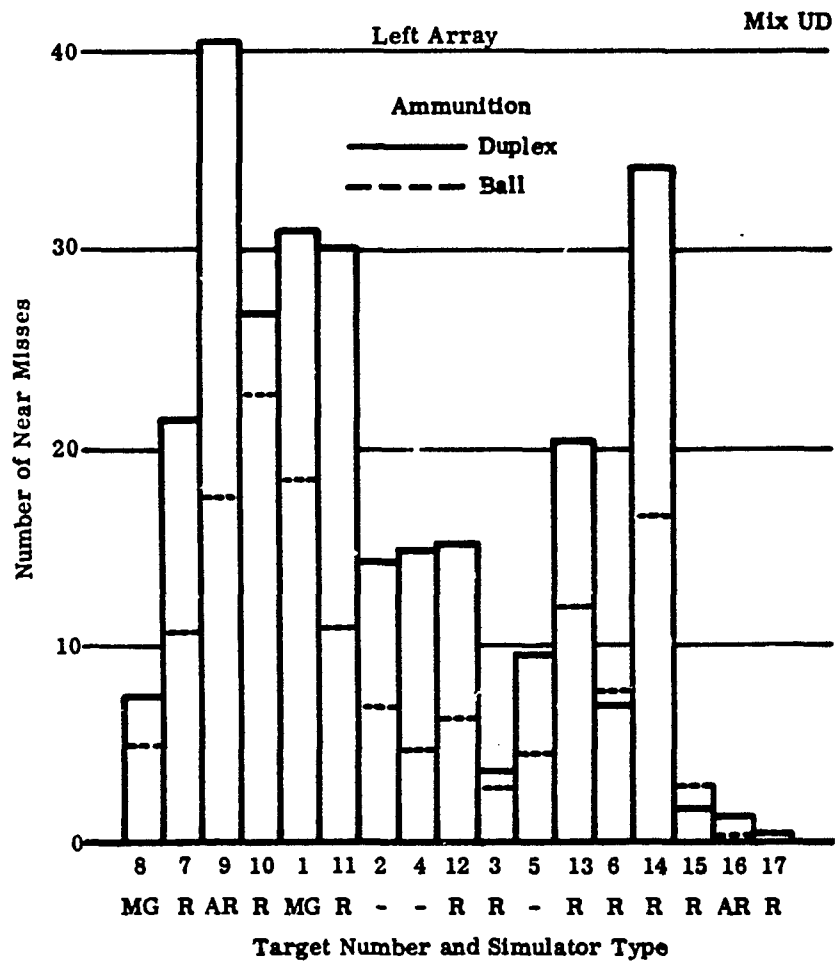
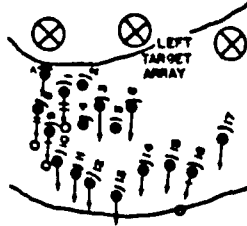

Figure 7-12  
 NUMBER AND DISTRIBUTION OF NEAR MISSES--SITUATION 1



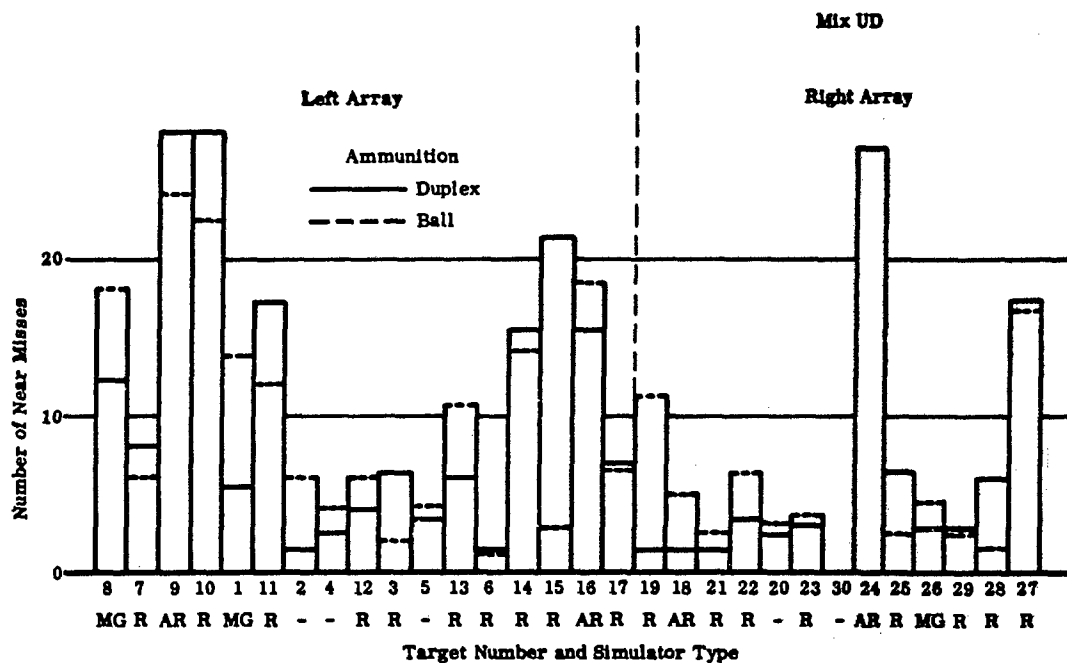
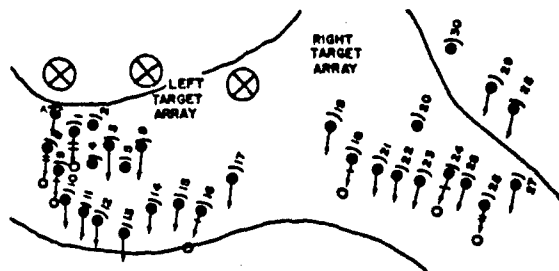

Figure 7-12 (Continued)  
 NUMBER AND DISTRIBUTION OF NEAR MISSES--SITUATION 2

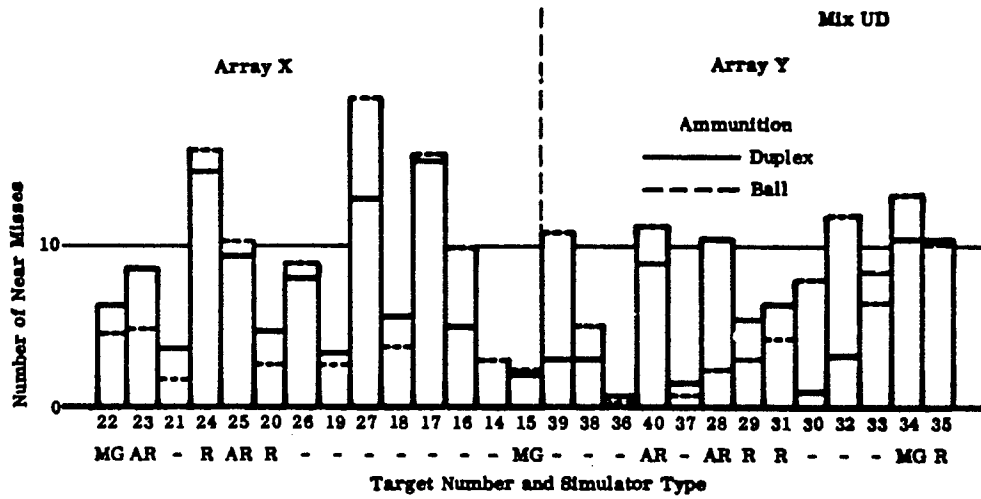

Figure 7-12 (Concluded)  
 NUMBER AND DISTRIBUTION OF NEAR MISSES--SITUATION 5

variable (expected duplex scores). These results are the most meaningful, precise, and valid of the two sets. However, the results and conclusions drawn from them prove almost identical, regardless of the set (raw scores or adjusted scores) used. Distribution of hits and near misses (not adjusted) are also provided (Figures 7-13 through 7-15).

Table 7-7 shows expected duplex scores. These are the scores that would have been expected if the machinegun squads had fired duplex instead of ball ammunition during their first firing of the various situations. The first firing scores were adjusted by applying mathematical corrections derived from the first and second firing scores of all six squads of the mix (squads firing duplex and squads firing ball). These expected duplex scores are directly comparable and each represents the contribution of all six machinegun squads of each mix.

In Table 7-6, the probability values (p) have been computed using a two-sample t-statistic. (See page 3-3 for explanation of probability values.)

In firing supporting fires at concealed and partially concealed targets (primarily distributed area fire) at a 300 meter range (Situation 3) duplex ammunition proved superior to ball ammunition for both bipod and tripod machineguns in target effects and overall effectiveness. While being fired at visible point targets (Situation 9) at ranges of 45 meters to 320 meters duplex ammunition proved superior to ball in target effects and overall effectiveness. Thus, the experimental results indicate that for both the bipod and tripod machineguns, at ranges out to 300 meters in both point fire and distributed area fire, duplex ammunition is superior to ball ammunition. However, at ranges of 450 meters to 750 meters (Situation 6) ball ammunition proved superior to duplex for both bipod and tripod machineguns firing primarily distributed area fire but with some aimed point fire whenever an actual target appeared.

Results indicate therefore that, for the machinegun, duplex ammunition is superior at ranges out to 300 meters while ball ammunition is superior at ranges beyond 450 meters. At an unknown point somewhere between 300 and 450 meters the effectiveness of ball ammunition for machineguns surpasses that of duplex.

**Table 7-7  
 EXPECTED DUPLEX SCORES  
 (Machinegun Duplex Experiment)**

<b>Effectiveness Measures</b>	<b>Original Ball Ammunition Score</b>	<b>Expected Duplex Score</b>
<b>Situation 3 - Fire Support of Assault Mix UE, M60 Bipod Machinegun</b>		
CET (min.)	92.6	82.83
Near Misses	246.4	277.18
Sustainability	51.2	42.11
Targets Hit	4.2	7.66
Total Hits	5.0	8.67
<b>Mix UF, M60 Tripod Machinegun (with T&amp;E mechanism)</b>		
CET (min.)	87.8	75.61
Near Misses	273.8	343.49
Sustainability	41.8	51.20
Targets Hit	6.8	21.85
Total Hits	7.8	22.30
<b>Situation 6 - Fire Support of the Advance Mix UE, M60 Bipod Machinegun</b>		
CET (min.)	63.6	65.56
Near Misses	228.0	220.64
Sustainability	78.5	82.31
Targets Hit	6.0	4.32
Total Hits	7.0	3.51

Table 7-7  
**EXPECTED DUPLEX SCORES**  
 (Machinegun Duplex Experiment) (Concluded)

Effectiveness Measures	Original Ball Ammunition Score	Expected Duplex Score
Situation 6 - Mix UF, M60 Tripod Machinegun (no T&E mechanism)		
CET (min.)	56.5	52.91
Near Misses	308.2	261.05
Sustainability	65.5	66.91
Targets Hit	12.2	7.43
Total Hits	13.8	7.10
Situation 9 - Defense Against Attack Mix UE, M60 Bipod Machinegun		
CET (min.)	9.1	8.36
Near Misses	--	--
Sustainability	88.1	78.95
Targets Hit	39.5	43.67
Total Hits	65.1	78.27
Mix UF, M60 Tripod Machinegun (no T&E mechanism)		
CET (min.)	8.0	7.21
Near Misses	--	--
Sustainability	79.9	82.74
Targets Hit	43.1	40.39
Total Hits	67.0	83.85

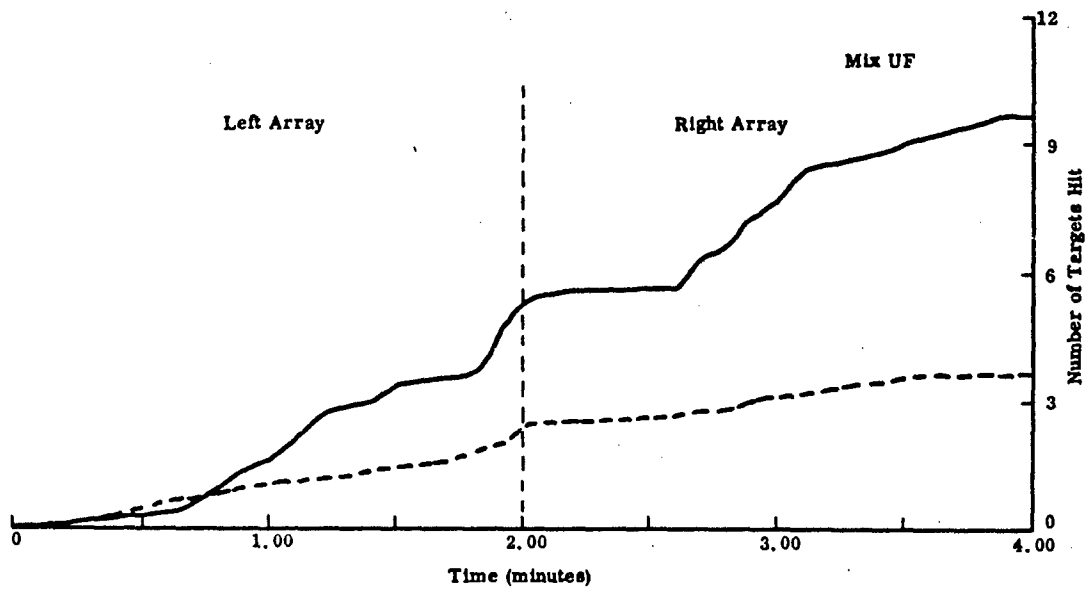
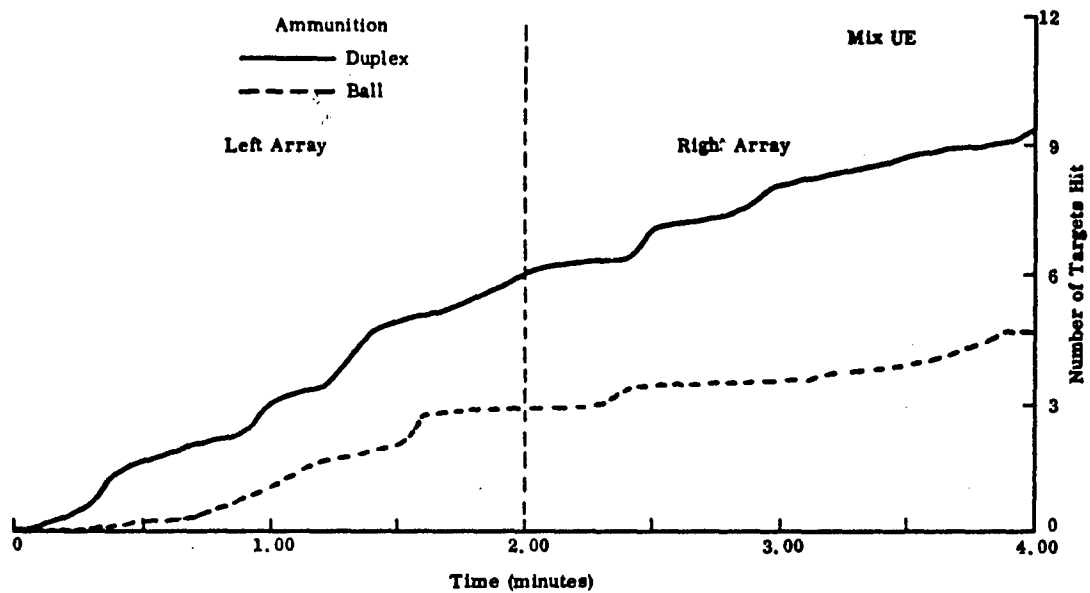

Figure 7-13  
CUMULATIVE NUMBER OF TARGETS HIT--SITUATION 3

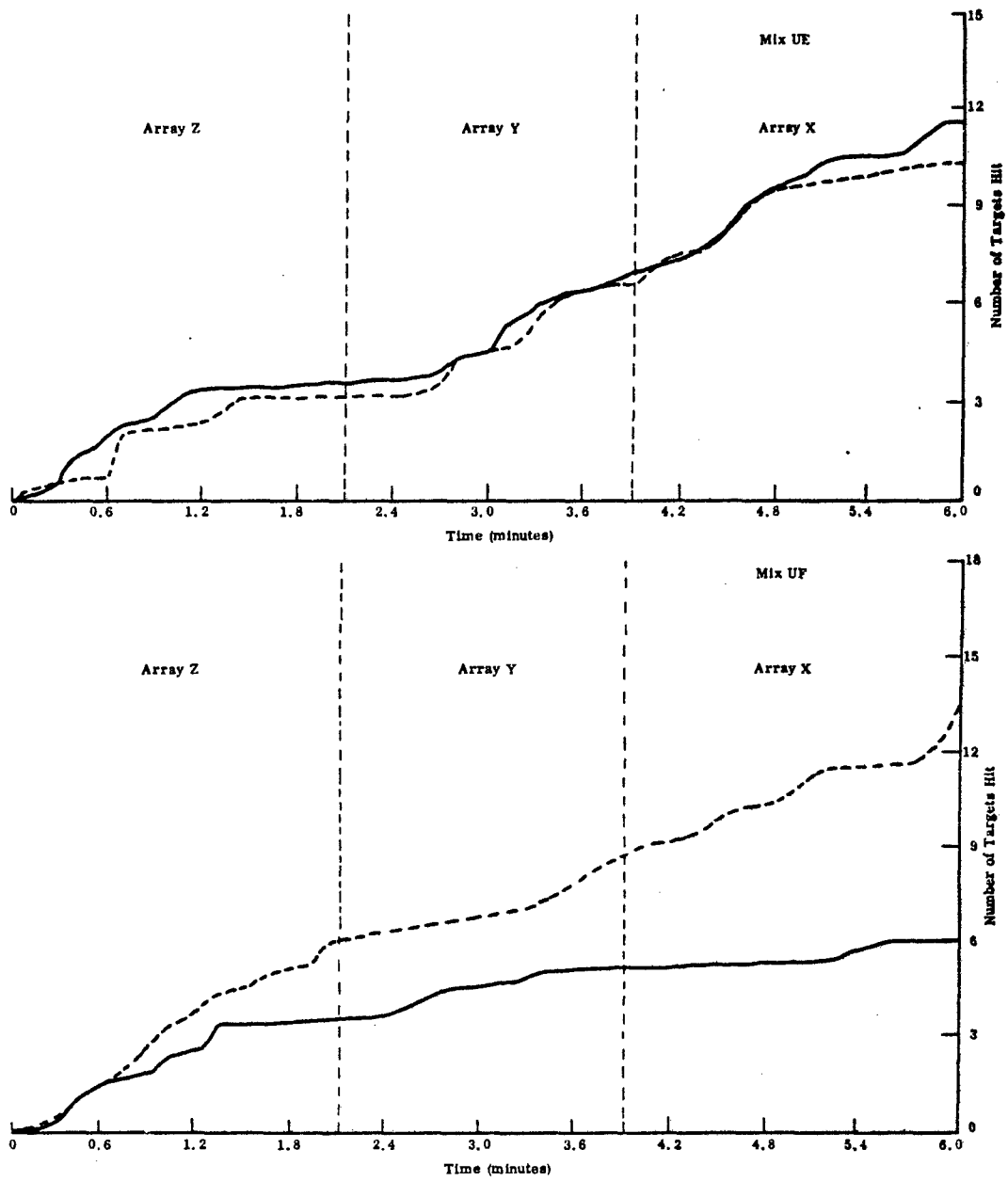

Figure 7-13 (Concluded)  
CUMULATIVE NUMBER OF TARGETS HIT--SITUATION 6

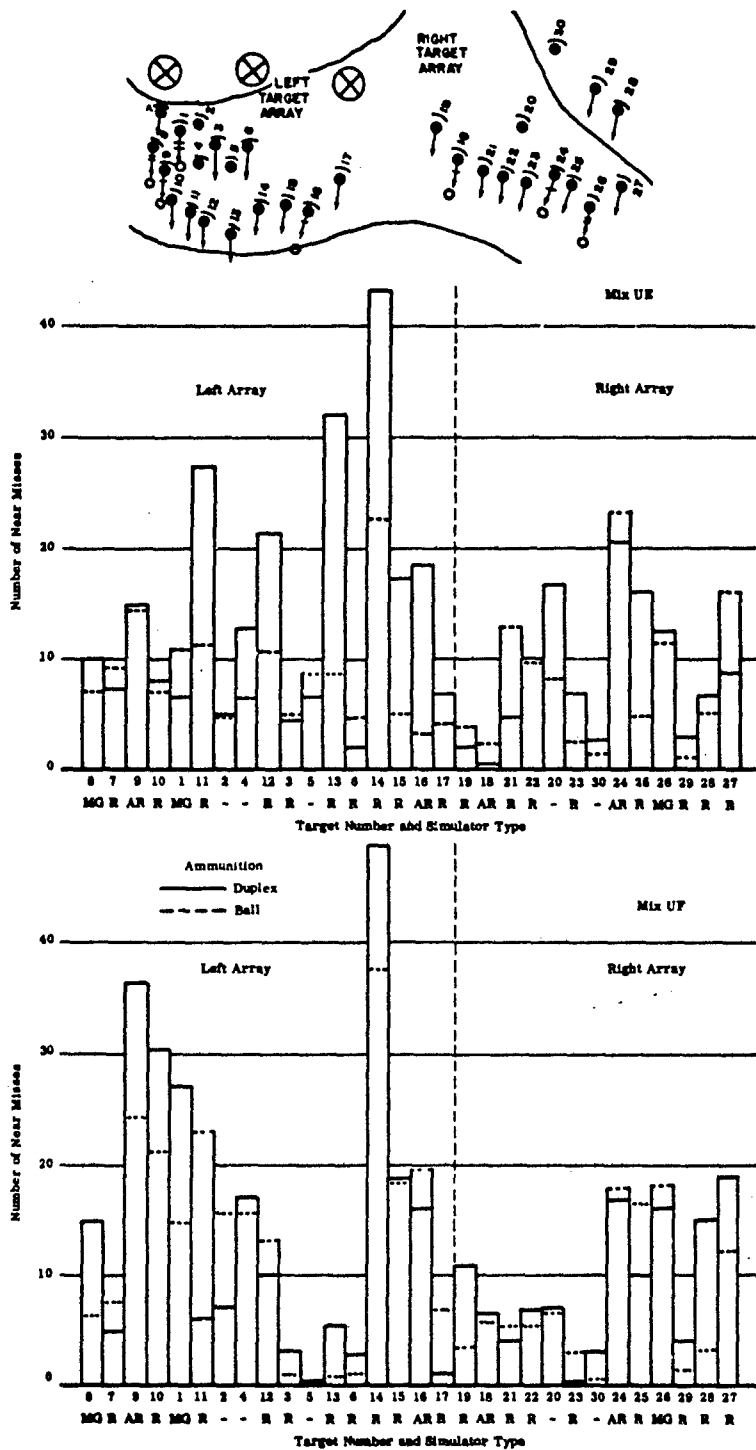
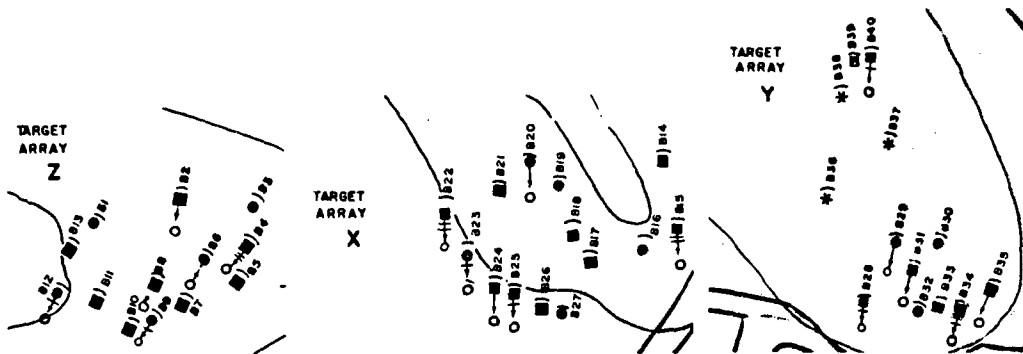

Figure 7-14 NUMBER AND DISTRIBUTION OF NEAR MISSES--SITUATION 3





Mix UE

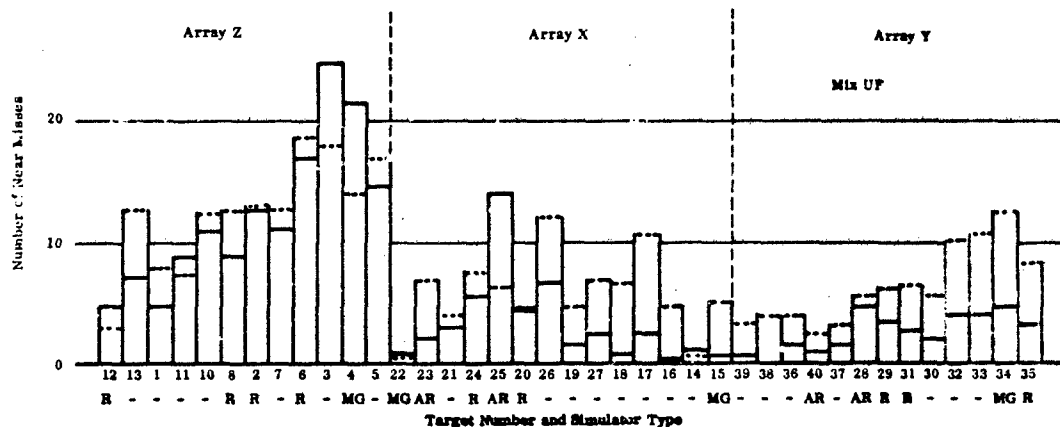
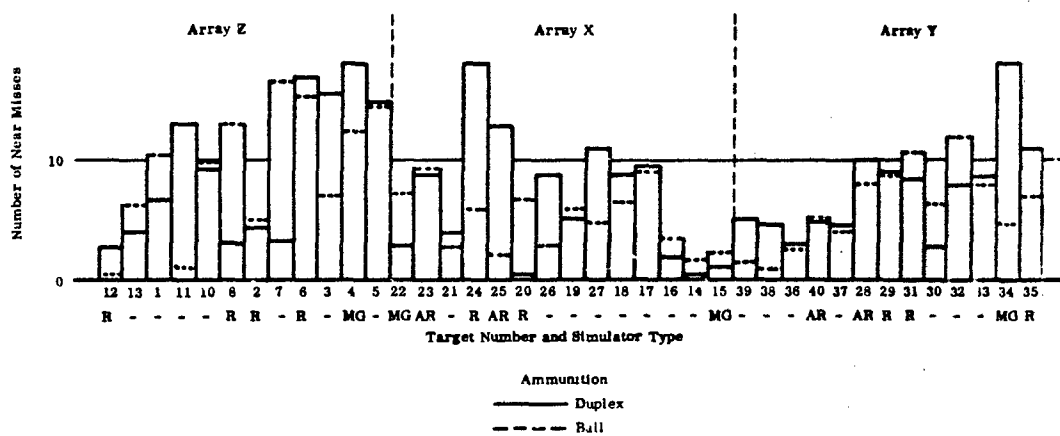

Figure 7-14 (Concluded)

NUMBER AND DISTRIBUTION OF NEAR MISSES--SITUATION 6

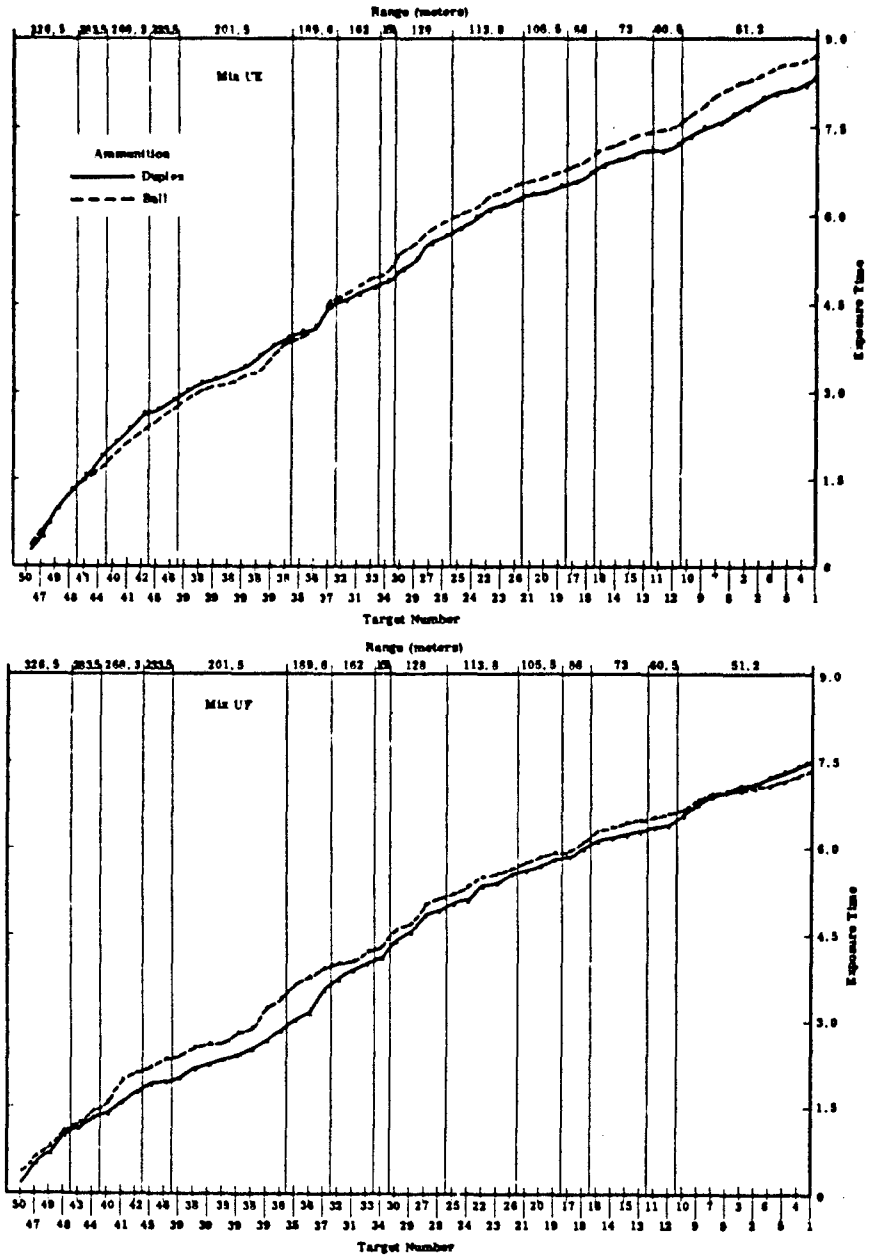

Figure 7-15  
 CUMULATIVE EXPOSURE TIME--SITUATION 9

## SECTION VIII

### LETHALITY DATA IMPLICATIONS

Pertinent lethality data were analyzed and studies performed. This included a review and analysis of the literature from 1928 to the present.

Current existing lethality data were carefully evaluated in relation to existing 5.56mm and 7.62mm ball ammunition and the candidate weapons used in the USACDCEC SAWS experiment. As a result of this analysis by a team of military and medical personnel and operations analysts, it is concluded that considerations of lethality support the USACDCEC conclusions presented in Section IX of this report.

A summary and analysis of the lethality data appears in Annex E, Small Arms Lethality.

**BLANK PAGE**

## SECTION IX

### CONCLUSIONS

These conclusions are derived from analyses of the results presented in Sections IV, V, VI, and VII. The terms "target effects," "sustainability," and "overall effectiveness" are used as defined and illustrated in Section II and III.

1. Rifle squads armed with low muzzle impulse weapons are markedly superior in overall effectiveness to rifle squads armed with high muzzle impulse weapons.
2. Rifle squads armed with Colt weapons and rifle squads armed with Stoner weapons are approximately equivalent in target effects achieved.
3. Because of the lighter system weight and related advantages in sustainability, rifle squads armed with Colt weapons are superior to squads armed with Stoner weapons.
4. Rifle squads equipped only with Colt automatic rifles appear superior to all other squads evaluated in overall effectiveness. Further testing of this hypothesis and evaluation should be undertaken.
5. The hypothesis that the most effective squad is a squad equipped with Colt rifles with XM148 grenade launchers attached (to provide a SPIW-type dual "area fire-point fire" capability) is promising and should undergo further testing.
6. Hypotheses that high muzzle impulse weapons are superior to low muzzle impulse weapons at longer ranges (300 to 550 meters) are not supported.
7. Hypotheses that lightweight rifles with high sights and straight stocks, such as the M16E1, are inferior or inadequate in pointing fire are not supported.
8. Low muzzle impulse weapons are superior to high muzzle impulse weapons in both automatic and semiautomatic fire in night firing in the defense.
9. A squad equipped only with M14 rifles is superior to a squad equipped with any other single US 7.62mm weapon, or combination of these weapons.

10. The M14E2 automatic rifle is unsatisfactory in overall effectiveness for use in the rifle role in the rifle squad.

11. It cannot be concluded that the low target effects of the AK47 rifle in the USACDCEC SAWS Field Experiment are indicative of the performance of the AK47 rifle in general.\*

12. The AK47 rifle (Soviet, East German and Chinese Communist) is significantly more reliable than any US 7.62mm or 5.56mm weapon.

13. The M60 machinegun is not suitable for use in the rifle squad because: 1) the system weight requires a two-man crew; 2) the sustainability of the weapon is marginal, even with a two-man crew; and 3) the size and weight of the weapon make it extremely difficult to manage in a moving firing situation.

14. The low muzzle impulse machinegun is a feasible weapon of incorporation into the rifle squad in the conventional automatic rifle role, or into a new squad organization context in the machinegun role.

15. The 5.56mm Stoner machinegun is judged to have a high reliability potential.

16. The standard 5.56mm ammunition provided for the experiment is not satisfactory because of fouling characteristics, the pressure mismatch of propellants in the ball and tracer cartridges, and primer sensitivity. These ammunition deficiencies are judged readily correctable.

17. The 5.56mm machinegun belt links provided for the experiment were not made to design specifications and are not satisfactory for use with the Stoner machinegun. This deficiency is readily correctable.

18. Neither the 7.62mm nor the 5.56mm tracer rounds are considered satisfactory for use by the firer in adjusting fire during daylight hours.

19. For aimed fire on visible point targets during daylight, semiautomatic fire is superior to automatic fire. This is true for all rifles, both low and high muzzle impulse. This does not imply, however, that automatic fire may not be superior in suppression effects and hits on adjacent concealed targets.

20. At ranges of less than 500 meters duplex ammunition under most circumstances provides a significant increase over simplex ball

\* The nine AK47 rifles used in the experiment were shared by all experimentation subjects. Amount of use of the weapons before the experiment was unknown, and a variety of types of foreign ammunition was used in the experiment.

ammunition in the number of targets hit, the number of total hits on targets that are hit, the timeliness of hits, and the number of near misses as an indication of suppression. Under no circumstances does its use significantly decrease effectiveness at ranges of less than 500 meters.

21. Duplex ammunition is most effective at close ranges with its advantage in effectiveness over simplex ammunition decreasing as range increases.

22. The concept of duplex ammunition applies equally to 7.62mm and 5.56mm ammunition.

23. Considerations of the relative lethality of 5.56mm and 7.62mm ammunition (with the possible exception of duplex) support all of the CDCEC SAWS conclusions. It is concluded that there are no tactically significant differences between 5.56mm and 7.62mm ammunition per round of ammunition; however, 5.56mm ammunition is significantly superior to 7.62mm ammunition in lethality per pound of ammunition or per basic load carried by the soldier.

END  
DATE  
FILMED  
11-7-66



# **EXHIBIT 8**

UD  
383  
H57  
1952

MEMORANDUM  
ORIGIN

UNCLASSIFIED



# ORO

OPERATIONS RESEARCH  
OFFICE

The Johns Hopkins  
University

## Operational Requirements

U.S. ARMY MILITARY HISTORY INSTITUTE  
CARLISLE BARRACKS, PA 17013-5008

for an

# INFANTRY HAND WEAPON

By Norman Hitchman

Statistical Analysis by Scott Forbush and George Blakemore Jr.

This document is now unclassified, as shown on the cover or title page, and all other markings found on any pages are obsolete. If any photocopies are made of this document, all markings, other than UNCLASSIFIED, on each page should be obliterated so that there is no misunderstanding of the current classification of any information derived from it.

REGRADER UNCLASSIFIED BY  
ALJ/MS/10/10/00  
BY *[Signature]*

Operating Under  
Contract with the  
DEPARTMENT OF THE  
ARMY

LIBRARY  
ARMY WAR COLLEGE  
CARLISLE BARRACKS, PA  
Received 19 June 1962

UNCLASSIFIED

UNCLASSIFIED  
SECURITY INFORMATION  
DECLASSIFIED AT 7 YEAR INTERVALS.  
DECLASSIFIED ON 12/13/88 BY 1043  
DOD DIR 526810

THIS IS A WORKING PAPER

Presenting the considered results of study by the ORO staff members responsible for its preparation. The findings and analysis are subject to revision as may be required by new facts or by modification of basic assumptions. Comments and criticism of the contents are invited. Remarks should be addressed to:

The Director  
Operations Research Office  
The Johns Hopkins University  
6410 Connecticut Avenue  
Chevy Chase, Maryland

LIBRARY  
ARMY WAR COLLEGE  
CARLISLE BARRACKS, PA

UNCLASSIFIED



# abstract

## OPERATIONAL REQUIREMENTS FOR AN INFANTRY HAND WEAPON

by

*Norman A. Hitchman*

Statistical Analysis

by

*Scott E. Forbush*

*George J. Blakemore, Jr.*

Of what should a rifle be capable in battle today? Since there is a limit, as to how accurately the infantryman fires, can one increase hits by giving him a rifle with new operational characteristics? ORO's Project BALANCE studied this by taking data on how often, and by how much, riflemen missed targets (as well as the distribution of hits) at different ranges, by taking data on the ranges of engagement in battle, and by taking data on the physiological wound effects of shots with differing ballistic characteristics. The recommendation is made that Ordnance proceed to determine the technological feasibility of a weapon with operating characteristics analyzed in this memorandum. This follows from conclusions which are listed only sketchily below:

- Hit effectiveness using the M-1 is satisfactory only up to 100 yards and declines very rapidly to low order at 300 yards, the general limit for battlefield rifle engagements.
- A pattern-dispersion principle in the hand weapon would tend to compensate for human aiming errors and increase hits at ranges up to 300 yards.
- Missiles, smaller caliber than now standard, could be used without loss in wounding effects and with logistical advantage, and a great increase in hit lethality could be effected by using toxic missiles.

date

abstract taken by

iii

UNCLASSIFIED

ORO-T-160

Fig. 16

Copyright © 1952, Operations Research Office  
 6110 ... 51 Pages, 11 Tables  
 Revised - 19 June 1952  
 Project BALANCE

~~CONFIDENTIAL~~  
U. S. Army Military History Institute  
**UNCLASSIFIED**

*Technical Memorandum ORO-T-160*

# OPERATIONAL REQUIREMENTS FOR AN INFANTRY HAND WEAPON

by

Norman A. Hitchman

Statistical Analysis

by

Scott E. Forbush  
George J. Blakemore, Jr.

LIBRARY  
ARMY WAR COLLEGE  
CARLISLE BARRACKS, PA.

*Received: 19 June 1952*

Project BALANCE



OPERATIONS RESEARCH OFFICE,  
The Johns Hopkins University,  
Chevy Chase, Maryland

Copy 67 of 250  
Log No. 21938

~~CONFIDENTIAL~~  
**UNCLASSIFIED**

**PROPERTY OF US ARMY**

~~SECRET~~ #18280 PROPERTY OF U.S. ARMY

# Unclassified

~~SECRET~~

## ACKNOWLEDGMENT

The author gratefully acknowledges the valuable assistance given by Col. E. M. Parker, Project Chairman, in the preparation of this study; especially were his paraphrases welcomed, for they crystalized areas of thought where otherwise the author would have faltered.

# Unclassified

vii

~~SECRET~~ INFORMATION

# Unclassified

## CONTENTS

	Page
ABSTRACT	iii
ACKNOWLEDGMENTS	vii
SUMMARY	1
Purpose — Assumptions — Discussion — Conclusions — Recommendations.	
OPERATIONAL REQUIREMENTS FOR AN INFANTRY HAND WEAPON	5
Introduction	
COMBAT CASUALTY STUDIES	7
Former Studies — Lethality of the Rifle — Rifle Bullet Hits as a Function of Range in Combat — Man-Rifle Operations Studies.	
TERRAIN VISIBILITY STUDIES	10
Range Requirements and Tactical Employment of Hand Weapons — Map Analysis.	
THE RIFLEMAN AND HIS WEAPON	15
Marksmanship: Tests and Analyses — The Pattern Salvo Weapon — Full-Automatic Fire — Wound Ballistics: Missile Caliber, Mass, and Velocity.	
LETHALITY	25
Weapons in General — The Rifle — Comparison of an Ideal Dispersion Automatic with M-1 Single-Shot Fire — Can Lethality Be Increased?	
THE DISPERSION WEAPON	31
Basis of Issue (T/O&E) — Training — Design Feasibility.	

Unclassified

~~SECRET~~ INFORMATION 718446  
**Unclassified**

CONTENTS (Continued)

Page

TABLES

- |    |  |    |
|----|--|----|
| 1. | Computed Distribution of Hits as Function of Range R.  | 36 |
| 2. | Relative Effects of M-1 Single-Round Fire and Salvo Fire as Function of Range for Terrain Classes A and C. | 38 |

**Unclassified**

~~SECRET~~ INFORMATION



~~CONFIDENTIAL~~

Unclassified

SUMMARY

PURPOSE

The study reported upon in this memorandum was undertaken for the purpose of determining the desirable operational characteristics of a general purpose infantry hand weapon.

ASSUMPTIONS

It has been assumed that it is desirable to increase in both number and rate the hits which may be inflicted on the enemy by aimed small arms in the hands of the infantry.

It has been further assumed that it is desirable also to increase the mortality of wounds caused by these hits.

DISCUSSION

In this examination of the basic infantry weapon, the rifle, two commonly accepted considerations or premises were carefully scrutinized, and their bearing upon infantry operations evaluated: 1) the time taken to hit enemy man targets is vital in that hits should be inflicted as early and at as great a range as possible; and 2) these hits should inflict significant injury—should be at least immediately incapacitating (in some circumstances, lethal). The findings are generally affirmative with respect to both propositions.

Study of combat records of operations, as well as field investigations of the man-rifle combination, shows that much is to be gained by increasing the hit capability of aimed rifle fire at the common battle ranges, and that increasing the severity of the hits is also to be sought. How men actually use the rifle in combat, the ranges of engagement most frequently recurring in battle, how terrain limits intervisibility of opposing firing

ORO-T-160

~~CONFIDENTIAL~~  
Unclassified

Unclassified

SECURITY ~~SECRET~~ INFORMATION #18448~~Unclassified~~

lines, and what is required ballistically to create physiologically desirable wound effects on the enemy, are factors which have been analyzed for the purpose of determining the operational requirements of a general purpose hand weapon.

Study of the various factors involved has yielded a number of independent but related and consistent determinations. Synthesis has permitted comprehensive evaluation of the combat actions bearing in concert upon effective employment of the hand weapon.

Battlefield visibility data show why combat rifle fire is actually so limited in range by normal terrain obstructions to the line of sight as rarely to exceed 300 yd. Studies of the manner in which gunshot wounds are incurred in battle suggest that lesser-included ranges are in reality the important ones. Measurements of marksmanship show that performance is of a very low order beyond a range of 300 yd. Wound ballistic data offer convincing evidence that small caliber, high velocity missiles may be used profitably at such ranges, without loss in wounding effects and with significant logistical gains.

The mutually confirmatory nature of the several findings goes far to explain present rifle operations, and to suggest the desirable characteristics for a general purpose infantry hand weapon. The conclusions which follow have emerged.

## CONCLUSIONS

1. The ranges at which the rifle is used most frequently in battle and the ranges within which the greater fraction of man targets can be seen on the battlefield do not exceed 300 yd.
2. Within these important battle ranges, the marksmanship of even expert riflemen is satisfactory in meeting actual battle requirements only up to 100 yd; beyond 100 yd, marksmanship declines sharply, reaching a low order at 300 yd.
3. To improve hit effectiveness at the ranges not covered satisfactorily in this sense by men using the M-1 (100 to 300 yd), the adoption of a pattern-dispersion principle in the hand weapon could partly compensate for human aiming errors and thereby significantly increase the hits at ranges up to 300 yd.
4. Current models of fully automatic hand weapons afford neither these desirable characteristics nor adequate alternatives. Such weapons are valueless from the standpoint of increasing the number of targets hit when aiming on separated man-size targets.

Unclassified

SECURITY ~~SECRET~~ INFORMATION

~~SECURITY SECRET INFORMATION~~  
Unclassified

5. Certain of the costly high standards of accuracy observed in the manufacture of current rifles and ammunition can be relaxed without significant losses in over-all hit effectiveness.

6. To meet the actual operational requirements of a general purpose infantry hand weapon, many possibilities are open for designs which will give desirable dispersion patterns (and accompanying increases in hit probability) at the ranges of interest. Of the possible salvo or volley automatic designs,\* the small caliber, lightweight weapon with controlled dispersion characteristics appears to be a promising approach. (Low recoil of a small caliber weapon facilitates dispersion control.)

7. To create militarily acceptable wound damage at common battle ranges, missiles of smaller caliber than the present standard .30 cal can be used without loss in wounding effects and with substantial logistical and over-all military gains.

8. A very great increase in hit lethality can be effected by the addition of toxic agents to bullet missiles.

RECOMMENDATIONS

1. It is recommended that the Ordnance Corps proceed to determine the design or technological feasibility of developing a hand weapon which has the characteristics cited in this analysis, namely:

- a. Maximum hit effectiveness against man targets within 300 yd range. (This does not mean that the weapon will be ineffective beyond this range.)
- b. Small caliber (less than .30).
- c. Wounding capability up to 300 yd at least equivalent to the present rifle.
- d. Dispersion of rounds from salvos or burst controlled so as to form a pattern such that aiming errors up to 300 yd

\*Current military usage of the two words salvo and volley is confused. By "salvo" the Navy and Air Force generally mean, respectively, the simultaneous discharge of several pieces, or the simultaneous release of a number of bombs; the Army usually employs the word to indicate the successive firing of several guns within a single command unit. "Volley" is commonly taken by all services to mean the simultaneous firing of a number of rifles or guns, with the exception that the artilleryman often applies the word to the independent (unsynchronized) firing of a certain specified number of rounds by each of several associated pieces. What is discussed here and in the following pages is either a simultaneous, or a high cyclic rate, burst, with the number of rounds per burst automatically set rather than dependent upon trigger release. In the former design, controlled nutation of the rifle muzzle would provide the desired shot dispersion or pattern; in the latter, the scatter would be obtained and controlled by multiple barrels, a mother-daughters type of projectile, or projection of missiles in the manner of a shotgun.

Unclassified

SECURITY ~~SECRET~~ INFORMATION #18450

# Unclassified

will be partly compensated, and hit effectiveness thereby increased for these ranges.

2. As one possible alternative to the current "volume of fire" (fully automatic) approach to the problem of increasing the effective firepower of infantry riflemen, it is recommended — subject to tentative confirmation of design feasibility—that a rifle incorporating at least in principle the military characteristics here proposed be manufactured for further and conclusive test.

Unclassified

~~SECRET~~ INFORMATION

~~SECURITY INFORMATION~~  
~~SECRET~~  
Unclassified

## OPERATIONAL REQUIREMENTS FOR AN INFANTRY HAND WEAPON

### INTRODUCTION

The subject of this study is of a basic nature for it applies to the basic weapon of the basic branch—the rifle carried by the infantry. Because the hand arm offers certain capabilities not duplicated by any other means, and because it is basic to the whole weapons system, the effectiveness of that weapon in battle is a subject of first importance in any general consideration of the whole fire system. It follows that any study directed toward a comprehensive examination of the aggregate of weapons for the purpose of designing and proportioning a “balanced” system (the mission of Project BALANCE) may logically take a beginning with this basic ground weapon.

Such an approach is, moreover, timely at the moment in the sense that the NATO is confronted now by an urgent requirement for standardization of a general purpose hand weapon for the infantry. Thus, any information which may be cogently pertinent to such weapons will have a bearing on an immediate problem of some moment.

The study here presented has been carried out not only in full recognition of the importance of improving the effectiveness of infantry, but also in growing awareness that the task—even though so basic in nature—is an exceedingly complex one. The effort has thus far been only preliminary. Limited time, and inadequate knowledge of basic unit operations in combat, have restricted the degree to which the whole problem might be examined. Consequently, no complete solution is offered by this memorandum; rather, some analytical findings are presented, which suggest the principles governing certain measures which could be undertaken to improve infantry effectiveness with respect to aimed rifle fire.

This memorandum bears directly upon the importance and the use by infantry of aimed small arms fire in the front line

Unclassified

~~SECURITY INFORMATION~~  
~~SECRET~~  
#16482

Unclassified

tactical fire fight, but does not consider expressly the importance, the techniques or the effects of unaimed "covering fire" delivered by small arms. The reason for directing the study effort toward aimed fire is that the common arm of the infantry, the rifle, is designed primarily for the aimed fire role; that is, the weapon is designed expressly to afford a capability of directing missiles at observed man-targets with high inherent precision, in both offensive and defensive action. Delivery by such a weapon of covering fire to neutralize or pin down the enemy and permit friendly maneuver is tactically useful, but nonetheless amounts to a secondary role for which design has provided only incidentally. The important question at hand, therefore, is not so much connected with the varying actual use of the present firearm as with the need of the infantry to engage the close enemy effectively by the use of aimed rifle fire, and with the feasibility of incorporating in the rifle of general issue the capability of answering this real requirement.

Recent ORO investigations in Korea have shed some light on this subject by indicating quantitatively the comparative importance of aimed and unaimed fire as related to offensive and defensive operations. Generally, aimed fire plays a more important part in defense than unaimed or volume fire, whereas in the offensive, the reverse is true. Almost irrespective of the part played by the supporting weapons before or during the final phase of close combat, the decision in each small tactical battle rests ultimately in large measure with the infantryman and his ability to use his hand weapon effectively. If hand-to-hand fighting develops at all, decision thus rests almost entirely with the infantry in this last time-phase of the tactical situation. To attach importance to this aspect of battle is therefore logical, and the attempt to maximize the capability of infantry in this role cannot be misdirected effort.

The study has yielded suggestions for increasing infantry effectiveness by improving the effects of aimed rifle fire. It appears almost certain that future large-scale ground operations will involve a numerically superior enemy and necessitate, at first, a defensive strategy on our part. Moreover, frequent attempts to overrun infantry positions, with attendant close combat, are to be anticipated. Thus, to increase each infantryman's capability with respect to defensive rifle fire becomes highly desirable.

In the light of such considerations as these, it appears correct to assume that: 1) it is desirable to increase in both number and

Unclassified

SECRET  
UNCLASSIFIED #18453

rate the hits\* which may be inflicted on the enemy by aimed small arms in the hands of the infantry; 2) it is also desirable to increase the mortality from wounds caused by these hits.

The research effort has included examination of casualties of past wars, studies of terrain as it limits battlefield visibility, determination of the marksmanship of men, wound ballistics requirements, actual use of the rifle in combat, and other considerations bearing on military operational requirements for the general purpose hand weapon. The determinations arrived at from the study of present rifle fire and its effects are presented in the following sections.

## COMBAT CASUALTY STUDIES

### Former Studies

Earlier work done by ORO on the defense of the individual in combat,<sup>1</sup> and a preliminary study of the offensive capabilities of the rifle,<sup>2</sup> yielded definite indications that rifle fire and its effects were deficient in some important military respects, and that further study of the problem would be necessary fully to establish the facts. In these former studies it was found that, in combat, hits from bullets are incurred by the body at random: regional distribution of bullet hits was the same as for fragment missiles which, unlike the bullet, are not "aimed." Further, it was found that exposure was the chief factor responsible for the distribution of hits from bullets and that aimed or directed fire does not influence the manner in which hits are sustained.<sup>3</sup> Stated briefly, the comparison of hits from bullets with those from fragments showed that the rifle bullet is not actually better directed towards vulnerable parts of the body.

The discovery of these facts, along with evidence of prodigious rifle ammunition expenditure per hit, strongly suggested the need to extend the study of the rifle problem. The facts known at this point also prompted one to regard with some dubiety the employment of the present, highly accurate, precision-made rifle as a general purpose infantry weapon. It should be noted, however, that complete verification would not suggest elimination of a precision long-range rifle to be used

<sup>1</sup>Footnote numbers refer to publications listed in Bibliography.

\*Multiple hits on the same target are much less to be desired than a large number of targets hit.

UNCLASSIFIED

~~SECRET~~  
 UNCLASSIFIED

by some men highly skilled and selected for specialist operations, e. g., snipers.

#### Lethality of the Rifle

As for the combat importance of hits from rifle bullets as compared to other weapons in the ground system, historical studies show that bullets have accounted for 10 to 20 percent of all hits from all ground weapons in most battles, campaigns, and wars of this century.\* Although these figures qualitatively provide a measure of the relative capability of hitting the opposed infantryman, they do not disclose capabilities with respect to severity of injury. Of these two factors (simple wounding and extent of injury) which characterize weapons effects, not much is known about either in the sense of cost versus effect because ammunition expenditures and corresponding casualty-producing effects are not usually known with precision. On the other hand, aside from the closely related machine gun, the rifle is the most lethal of all conventional ground arms: its lethal index (ratio of kills to hits) exceeds 30 percent, putting it above other weapons in capability of inflicting severe injury.\* The lethal index of the machine gun, of course, exceeds that of the rifle because multiple hits increase over-all lethality. For bullet lethality, the 30 percent figure given for the rifle would be the closest approximation to single round lethality for all ranges in battle.

#### Rifle Bullet Hits as a Function of Range in Combat

Knowledge of the ranges at which hits have been incurred in past wars is sharply limited. Since this parameter is almost indispensable to the military specialist or operations analyst in determining weapons effects, it is astonishing that greater efforts in the past have not been directed toward gathering information of this kind in combat operations.

\* In this analysis, the figure 30 percent refers only to enemy weapons of World War II type but since enemy rifles did not differ greatly from our own, the lethal index value should approximate that of the M-1 rifle. Strictly, lethal refers here to the bullet, rather than the rifle, which is the launcher. What is meant is that a larger fraction of the total bullet hits results in death than from hits from any other weapon. The explanation does not lie in the manner in which rifle bullets are directed, since data show that bullet hits occur on the body at random just as do hits from fragmenting projectiles and therefore their relatively high lethality is not connected with any bias in their distribution over the body. The reason appears to be connected with the higher (and more nearly constant) energy, on the average, than other missiles since they are discharged at short ranges. Fragments, however, vary in energy from a maximum to zero, with the mean value being relatively low because of the preponderance of small fragments per missile burst and because of the rapid deceleration of particle velocities with range.

~~SECRET~~  
 UNCLASSIFIED



~~SECRET~~  
#18455  
Unclassified

Only two studies exist which have reference to bullet hits as a function of range in battle, and they are based on indirect and possibly inaccurate measurements. Oughterson<sup>5</sup> analyzed experience on Bougainville in World War II and found that, of those cases studied, almost all rifle bullet hits were received at ranges less than 75 yd.\* The Surgeon General recently examined the wounded in Korea, and from a sample of 109 rifle bullet hits suffered among members of the Turkish Brigade, the mean range for these hits was found to be just over 100 yd.<sup>6</sup> It was noted, however, that most of the hits occurred at ranges within 300 yd and in a later section of this report these data along with data on battlefield visibility will be given more extensive treatment.

### Man-Rifle Operations Studies

The British AORG during World War II, and ORO in FECOM, have both attempted to study part of the man-rifle complex by interviewing experienced riflemen on their use of the weapon in offensive and defensive combat actions. The British examined officers and NCOs who had experience in the ETO<sup>7</sup> and ORO examined men with experience in Korea.<sup>8</sup> The agreement of the two independent studies is striking. For attack and defense in European actions, it was found that about 80 percent of effective rifle and LMG fire takes place at less than 200 yd and 90 percent at less than 300 yd, according to the estimates made by the men interviewed. About 90 percent of the LMG fire was at less than 300 yd.

Of 602 men questioned about use of the M-1 rifle in Korea, 87 percent said that at least 95 percent\*\* of all their firing was done at targets within 300 yd range (day time offensive fighting).<sup>9</sup> For day time defensive fighting, 80 percent of the men said that rifles were used at 300 yd or less. Figure 1 shows the frequency in which rifles are used as a function of range, based on responses of interrogated infantrymen. The approximate correspondence of the curves in the Figure indicates that the use of the rifle is to at least some extent dependent upon battlefield terrain features as they affect visibility.\*\*\* Although it is freely acknowledged that the use of data derived from judgments of the men about the use of their basic arm may be subject to question, the validity of the

\*This figure is perhaps atypically low because it refers to jungle fighting in which visibility was abnormally restricted.

\*\*The men were asked to give the outside limit of 95 percent of their firing in order to eliminate those rare shots which might be fired at long ranges without expectation of hitting the target.

\*\*\*See section on battlefield visibility.

Unclassified

SECURITY INFORMATION  
~~SECRET~~  
 UNCLASSIFIED  
 #18456

opinion survey has been substantiated by a more recent Korean study conducted in combat areas.<sup>9</sup> Also, as mentioned earlier, the analysis made by AORG tends to support the conclusion that

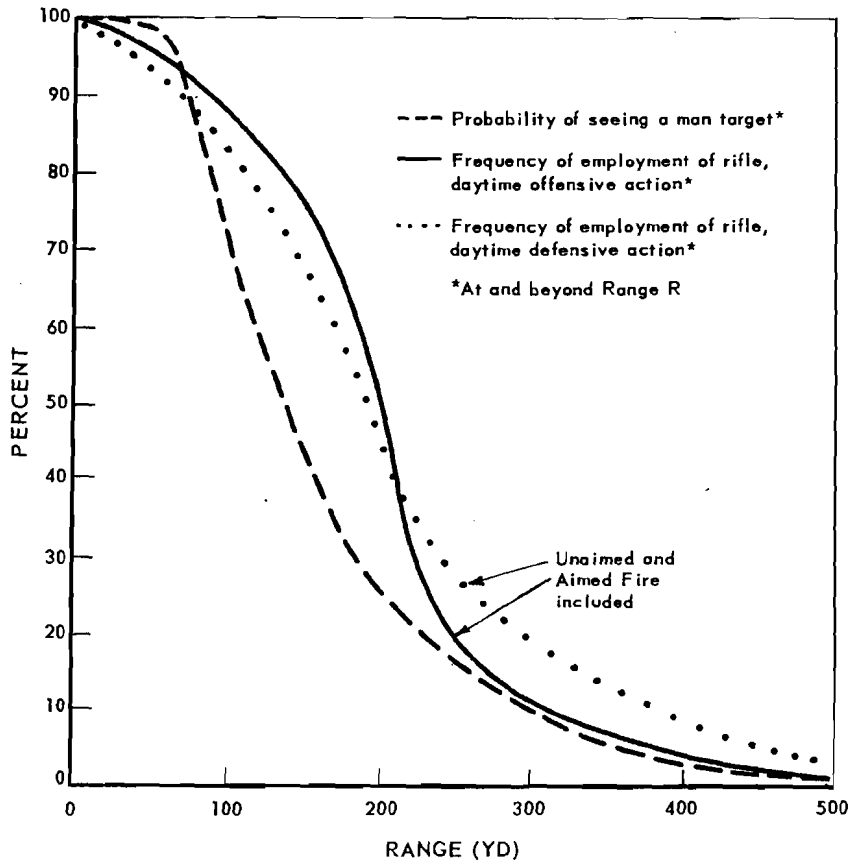

Fig. 1—Comparison of battlefield visibility in Korea and ranges of employment of the M-1 Rifle.

the infantry basic weapon is actually used, on the average, at shorter ranges than commonly believed.

**TERRAIN VISIBILITY STUDIES**

Range Requirements and Tactical Employment of Hand Weapons

Despite the important role of infantry support weapons (artillery, tactical aviation, armor, and others), the entire ground weapon system hinges in many important ways upon those weapons which depend for their effective employment upon ground observation of the target. These are the direct-fire and observed-fire weapons; they are elemental, basic, and indispensable to the infantry-artillery-armor team.

Unclassified

~~SECRET~~

SECURITY INFORMATION  
~~SECRET~~  
#18457  
Unclassified

For infantry, the basic direct fire weapon is the rifle—it is the common denominator upon which the entire fire system is designed, both physically and tactically. Yet all direct-fire weapons suffer a major weakness in that essential observation for their effective employment may be obscured by weather conditions, prevented by darkness or—more importantly and quite unavoidably—interrupted by terrain features. This interruption of the line of sight is one of the principal military effects of terrain, for the ranges at which points on the ground are inter-visible are related to the employment and general effectiveness of these direct-fire weapons. Accordingly, terrain limitations to continuous visibility on the battlefield should dictate to a considerable degree the actual design and employment of direct-fire or observed-fire weapons. A study of this subject which was undertaken by Project BALANCE and which is covered in detail in a separate report,<sup>10</sup> has yielded formulary expressions for the relationship between the opening range of engagement for riflemen and the range at which man-targets can be seen. Particularly with respect to the rifle, the study is basic in its concept and possibly, for the first time, data have been obtained which constitute a reasonable quantitative basis for determining the actual range requirements and tactical employment of a general-purpose hand arm.

Because of the importance of these findings to the infantry weapons problem, they should be studied carefully in conjunction with the work presented here on operational requirements for an infantry hand weapon.

### Map Analysis

Topographical map studies of a number of large scale (1:25,000) maps of various countries in the world have shown that it is possible to predict, with reasonable accuracy, the probability of being able to see continuously for a given distance from a random point within the area.<sup>10</sup>

For the infantry study, the procedure used in the map analyses was to measure the continuous ranges of visibility between infantrymen, with the position of one man (the defender) being at ground level (foxhole or prone) and the approaching enemy being an erect human target five feet high. This factor was chosen to set realistic limits on the range of intervisibility between opposing forces. The

ORO-T-160

11

SECURITY INFORMATION  
~~SECRET~~

~~SECRET~~  
#18458  
UNCLASSIFIED INFORMATION  
**Unclassified**

validity of the map readings was verified by actual terrain measurements\* and the findings are in general agreement with limited combat data from the Korean experience and ETO experience during World War II.\*\*

From the map study, it was found that all the types of terrain so far considered fall into one of three categories which are illus-

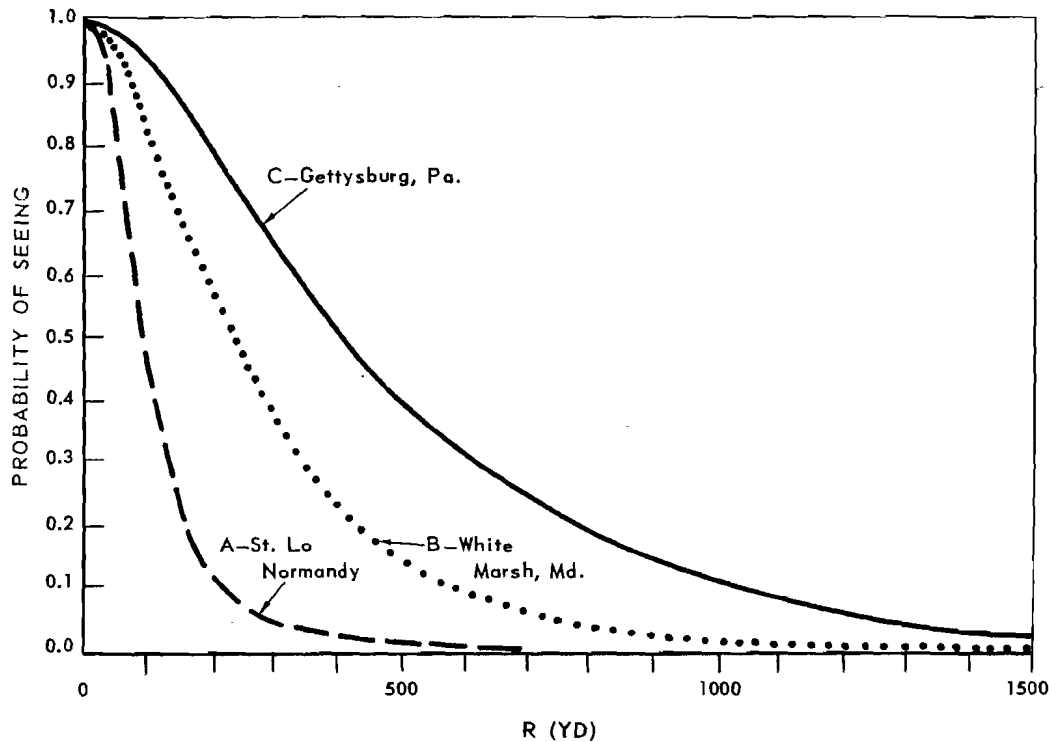

Fig. 2—Frequency distribution for ranges of continuous visibility for Terrain Classes A, B, and C. (Probability of seeing man-targets at ranges greater than R yards from a random point within the area covered by the map analysis.)

- \*Tests were conducted on the battlefield area of Gettysburg in which a small party of ORO analysts checked map predictions by actually walking over the terrain in accordance with the map bearings and measuring the distance of intervisibility. In every instance, distances of continuous visibility were found to be less than the distances predicted by map measurement because of terrain features and obstacles not shown on maps. Map readings were considered, therefore, to represent maxima.
- \*\*The mean ranges of visibility from map analyses of Korea and Normandy show remarkable agreement with limited combat knowledge of ranges of engagement between riflemen and between tanks. In Korea, the frequency of ranges for bullet hits agreed with the frequency of ranges for visibility. For World War II tank battles, both Peterson of Ballistics Research Laboratory and ORO (Ref. 10) have shown that ranges of engagement for tanks correspond with ranges of visibility in the battle areas as determined from map analysis. These two samples of combat data tend to validate the use of the map data for predicting range requirements.

**Unclassified**

~~SECRET~~  
Unclassified

trated by the three curves in Fig. 2. The frequency distribution for Type A terrain is typical for a country like the Saint-Lô area in Normandy, where visibility is sharply limited by the masses of hedgerows, small cultivated fields, orchards, and the nature of the terrain itself. Type A also describes rugged, mountainous terrain like Korea. The distribution curve for Type C describes relatively open country where the topography is gently rolling and large, open, cultivated areas exist. Type B is intermediate between the two extremes cited and describes an average type of cultivated countryside.

The importance of these data to the infantry study is related to the range requirements for infantry weapons and, as shown in Fig. 2, 95 percent of all observations include ranges which are much less than the range capabilities of many of the infantry direct fire weapons. The implication that such weapons may be over-designed is appreciated when it is considered that the rifle alone has a maximum range capability of 3,500 yd.

The following description of the procedure used in the map study is presented so that the practical application of the data may be recognized.

Figure 3 shows diagrammatically a corner section of a 1:25,000 map. The method of measurement was adopted from a suggestion by Peterson of Ballistics Research Laboratory who used map grid lines as guides for sampling any given terrain.

The analysis of each map is begun at Point A (northwest corner). Proceeding along the east-west grid line, the distance is measured from the edge of the map to the point where an erect (five feet) infantryman would just be obscured from the sight of a defending prone infantryman at Point A. In this case, the crest of a hill (contour) is the factor which obstructs visibility. After recording the distance A to B, the next point of obscuration is measured by proceeding along the grid line from Point B to Point C where a railroad embankment interrupts the line of vision. Distance BC is then recorded and so on along the grid line to the far edge of the map. It will be noted that a house or building limits visibility at Point D and woods limit vision at Point E.

After all horizontal grid lines are measured in this way, the same method is used on all vertical grid lines. Then all the obscurations from one map are used to plot a frequency distribution. Examples of such frequency distribution have been given already in Fig. 2.

Unclassified

~~SECRET~~

Although the frequency distribution curves yield predictions as to the probability of seeing man targets at Range R, from any random point on the terrain, it may be argued that infantrymen are not randomly located along the front but actually take up positions which have been selected for point of advantage (for example, high ground in the defence). So far as this is true for small units such as squads and platoons especially in defensive positions, such biases as a result of the placement of men are not systematic, and when division or corps fronts are considered, the density of man and their positions across a broad front can be considered to be more

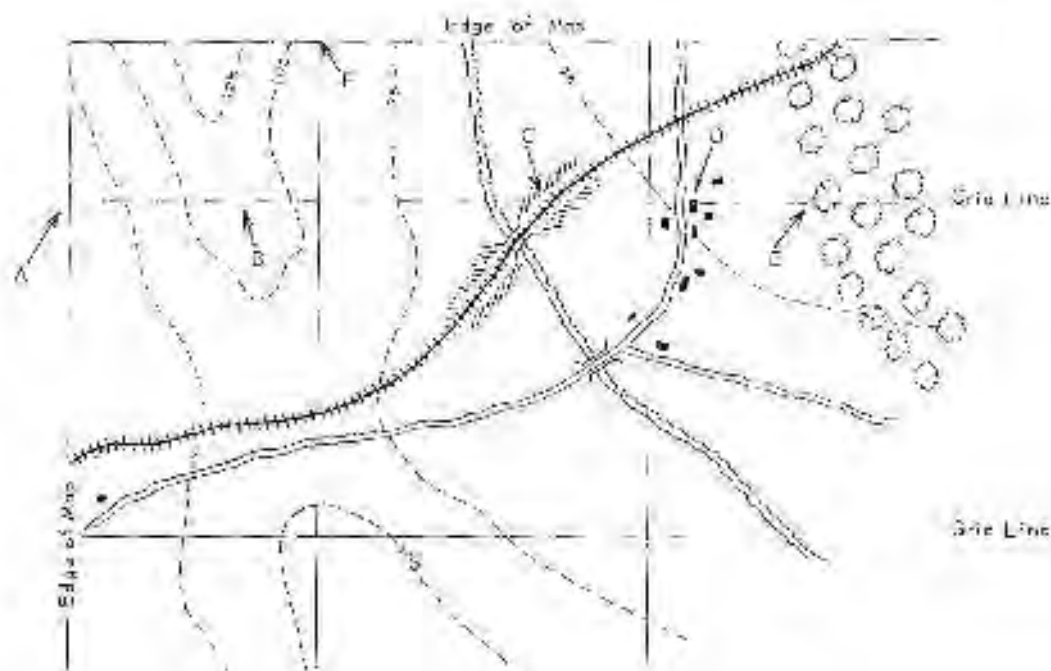

Fig. 3— Method used in measuring range of visibility on maps.

Starting at the northwest corner of the map one looks from the point A, where the first horizontal grid line begins, along that grid line to the point B where, because he has gone over the crest of a hill, the standing infantryman (the target) ceases to be visible. The distance AB is measured and recorded. Next, starting from B, one finds that the target is continuously visible until the railroad embankment at C causes obstruction to view; the distance BC is then measured and recorded. Similarly, starting from the top of the embankment, it is found that there is no obstacle until one reaches the nose at D; CD is measured and recorded. Next the distance DE is recorded, then, starting from the eastern edge of the wood, the distance to the next obstruction is measured, and so on across the map to the right margin. After all horizontal grid lines have been followed in this way, one starts again at the northwest corner and reads from E down the first vertical grid line and all the other grid lines. All the readings obtained in this way are used to plot a frequency distribution. Figures 2 through 4 are examples of such frequency distributions.

~~SECRET~~

or less uniform. Thus, in relation to terrain, their position is more nearly random. Also, no systematic selection of ground is permitted either side during a battle, since position, which is fluid and constantly changing, is dependent upon the whole battle situation and not just upon ground features. Therefore, the random selection on a map of a battlefield in any given terrain should predict the actual ground condition of the battlefield. In general, it is felt that men move in battle in a more or less random manner, so the data obtained in the visibility study are reasonably valid for predicting the probability of seeing targets over any area, particularly since the method used measured the type of movement used by troops in battle, that is, from cover to cover.

Employing this method, map studies of Canada, France, Germany, Korea, North Africa, and the US, to a total of some 18,000 readings, showed that 70 percent of the ranges at which an erect human target can be seen by a defending prone rifleman are less than 300 yd (and that 90 percent are less than 700 yd).

Since range requirements exert a considerable if not dominating influence upon such characteristics as weight, caliber, and missile velocity, the data from the map analyses have a very important bearing upon the design of an infantry hand weapon. Comparing the range analysis data with the maximum range of the present M-1 rifle (3,500 yd), and its design for incapacitating clothed personnel up to 1,200 yd, it may be concluded that the effective ranges of the greater part of infantry hand weapons could be reduced materially to an order suggested by the terrain analysis. (A reduction of the range of the rifle for maximum effectiveness up to 300 yd does not mean that the weapon would not be effective at ranges beyond this.)

## THE RIFLEMAN AND HIS WEAPON

### Marksmanship: Tests and Analyses

The preceding sections have described, to some extent, certain major factors dictating the actual operational requirements for the general-purpose hand arm of infantry. Since marksmanship obviously plays a major role in the over-all effectiveness of hand weapons employment in the military situation, the measure of the varying capabilities of combatants to use their weapons with tactical effectiveness becomes, along with target visibility, a significant parameter in the whole infantry study.

To provide meaningful data on this subject, field tests were conducted at Fort Belvoir, Virginia, where 16 expert riflemen (highest

~~SECRET~~ #18462  
 UNCLASSIFIED

grade) and 16 marksmen (lowest qualified grade) were used in a series of experiments designed to simulate some of the conditions of combat. The 32 men were divided into groups for two sets of tests. Firing the M-1 rifle from the prone position, using battle sights, they shot at a man-silhouette target operated on a transition-type range, at distances of 100-300 yd. Mounted behind the silhouette was a 6 foot high by 12 foot wide screen; on this could be measured the dispersion of rounds. The target butts were draped with OD cloth so that short rounds, not striking the target, could also be recorded. (These experiments and the results are described in detail in the Appendix.)

Further data were procured from a range test on automatic rifles at Fort Benning, Georgia.\*

In the tests at Belvoir, a variety of conditions was imposed on the participants chiefly by changing the time of target exposure and imposing forms of psychological duress. It was found that best results were obtained when single rounds were fired on an individual basis at static man-size targets. Marksmanship declined when group firing (4-man groups) was performed at the same targets. With slight psychological load, in the form of limited target exposure time and random order of presentation at varying ranges, a further decline in effectiveness was noted. Hit probability as a function of range for both grades of riflemen is shown in Fig. A4 (Appendix).

Significant results from these analyses are: (a) hit probability is high for both grades of riflemen at ranges up to 100 yd; (b) at ranges beyond 100 yd, a sharp decline in hit probability occurs and this decline in effectiveness is most marked at the common battle ranges, between 100 and 300 yd; (c) at 500 yd, both experts and marksmen perform unsatisfactorily, a performance quite inconsistent with the design capability of the weapon and with military specifications.\*\*

These findings provide part of the explanation for most frequent battle use of rifles at ranges less than 300 yd and for the

\*The author acknowledges the assistance of Lt Col D. E. Munson of ORO in arranging for these tests and in helping with test designs which were in keeping with the practical aspects of conditions of combat.

\*\*For the issue M-1 rifle and standard M-2 ammunition, the mean radial dispersion is about ten inches at a range of 500 yd. An indication of the discrepancy existing between the inherent accuracy of the weapon and ammunition, on the one hand, and that of the man-rifle combination, on the other, may be found by comparing miss probabilities at the range of greatest interest, namely 300 yd. In a machine or bench rest, the probability that the rifle-ammunition combination will miss the type E silhouette target (which approximates the head and torso region of an erect human target—projected area about 4.6 sq ft) at 300 yd is about  $PM = .040$ ; whereas, for marksmen firing individually, the probability of a miss is  $Pm = 0.76$ .

UNCLASSIFIED

~~SECRET~~ INFORMATION



~~SECRET~~  
#18463  
Unclassified

incurrence of the majority of rifle bullet wounds in combat within this range. Since deflection errors in aiming are independent of range (Appendix), the sharp decrease in hits beyond 100 yd is not to be attributed to men becoming less accurate at the longer ranges; the hit probabilities shown by the curves are a function of target size and range.

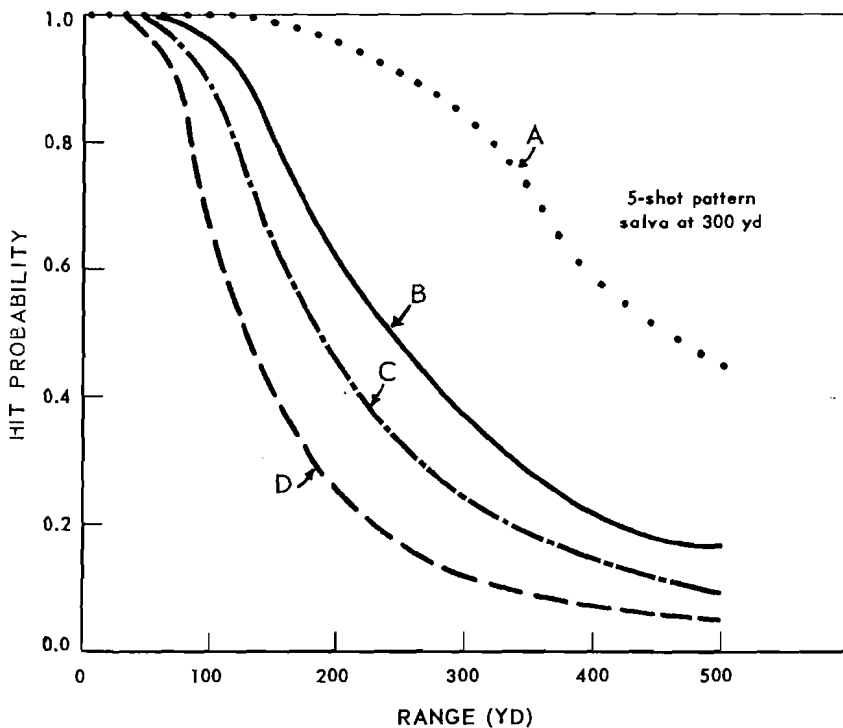

- A Experts individually firing new weapon
- B Experts firing individually
- C Marksmen firing individually
- D Marksmen firing simultaneously

Fig. 4—Marksmanship using the M-1 Rifle  
(Probability of hitting target as function of range)

The difference between expert riflemen and marksmen, although significant at some ranges in these tests, may or may not be meaningful in actual combat where man targets will be in movement and psychological duress will be high. In fact, in the rapid fire tests using targets randomly presented (see Appendix, Test 3), the marksmanship of experts declined significantly when compared to simultaneous firing in Tests 1 and 2. The same comparison for marksmen showed that the rapid fire test did not significantly affect their performance, indicating, perhaps,

Unclassified

~~SECRET~~ INFORMATION  
#18064  
Unclassified

that under the rigorous conditions of combat, only slight differences exist in marksmanship among the several qualifications as determined on the range.

In a fire fight, it is reasonably certain that marksmanship will be less effective than shown by the curves in the tests which, for this reason, are presumed to be optimistic as relating to the actual situation.

In connection with the dispersion inherent in the weapon and in the ammunition used, it is interesting to note that, at all common ranges, weapon errors are without significance in the man-weapon system. As already pointed out, considerable discrepancy exists between the accuracy of the weapon and that of the riflemen. In the Appendix, it is shown that the dispersion of the weapon could be more than doubled without materially affecting the probability of hitting the target. As shown in Fig. A43, weapons-design standards which seek perfection by making the rifle more accurate (approach zero dispersion) would not be reflected in improved marksmanship or musketry. Such high standards of precision and accuracy on the part of present designers are not supported by this analysis as genuine military requirements. Results of the analysis on marksmanship were also used to predict the value of using a weapon which would tend to compensate for man-aiming errors by firing a pattern salvo, or volley.\* In Fig. 4, one of the examples of hit effectiveness for such a weapon is presented (from the Appendix).

#### The Pattern Salvo Weapon

As shown by field test, errors in aiming have been found to be the greatest single factor contributing to the lack of effectiveness of the man-rifle system. In particular, the men who are graded by Army standards as expert riflemen do not perform satisfactorily at common battle ranges, a fact which casts grave doubt on any

\*The results of the tests on marksmanship already have astonished many persons because it was not expected that men would exhibit such low performance at the common ranges. The factors which possibly explain the disparity between the higher marksmanship scores from Army training methods, when firing on known distance ranges, and the lower scores from the ORO tests are apparently connected with the conditions of the tests which neither simulated Army methods of scoring or approached the true conditions of combat. Perhaps by adopting training methods along the lines of the tests conducted, the performance of men might show some general improvement. In any case, the test results are believed to be more indicative of the actual capabilities of riflemen in a military situation than the qualification score made when firing for record on the range. The ORO test data already have been used in other analyses relating to the weapons system and have proven of great value. Because they may prove useful to other workers in military analysis, the Appendix has been written to include most of the raw data in the form of tables and figures, resulting in "bulk" for which there is no other warrant.

Unclassified

~~SECURITY INFORMATION~~  
~~SECRET~~  
#18465

attempt at the development of skills through training which would begin to approach the accuracy of the weapon itself. Although careful selection and intensive training of personnel in the use of the rifle may accomplish much in improving marksmanship in peace time, the problems of rapid Army expansion and accelerated training in time of national mobilization preclude the opportunity to develop highly skilled riflemen in large numbers by selection or through prolonged training. This point is often overlooked by those who argue for better training as the only solution for the rifle problem. Actually, to reach truly proficient standards in marksmanship, the time required in training would greatly exceed the practical limits imposed on Army training schedules by the needs of mobilization.\*

In the search for alternatives to an extensive (and impracticable) training program, consideration was given to the possibility of compensating for man-aiming errors through a weapon-design principle. The results of the marksmanship study indicate that a cyclic or salvo-type automatic fire arm offers promise of increasing hit effectiveness if the missiles in a burst or salvo were projected so as to be dispersed randomly or uniformly around the point of aim. Obviously, a uniform type of dispersion would be more desirable than random dispersion if hit effectiveness were to be maximized. In considering such a weapon, two points required determination: (a) a practical limit on the number of rounds per burst or volley; and (b) the pattern design of the rounds to be delivered.

In the Appendix, the consideration of four- and five-round salvos was not arbitrary. Wound ballistics data show that small caliber missiles of high velocity could be used in the new weapon (see section on Wound Ballistics), which suggested the possibility of obtaining logistic equivalence (that is, equivalence in weight of weapon and ammunition carried) between a four-round salvo and present single-shot rifle fire\*\*; also, not less than four rounds would be required to form a symmetrical pattern (diamond-shaped)

\*One expert rifleman at Fort Benning, Georgia, estimated that it required nine years of continuous training on fire arms to develop marksmanship to the proficient level which he now enjoys. Sgt. Justice's performance in demonstrating the use of infantry hand weapons is most dramatic. His skill in marksmanship actually approaches the accuracy of the weapon; he has attained a level of performance roughly commensurate with the design precision of the weapon. However, it is estimated that less than 10 percent of the men in the normal recruit stream could possibly reach this level of small arms proficiency, even if time allowed for training were long.

\*\*Calculations actually reveal that, for a high velocity, .21 cal missile of 60 grains, the ratio of cartridge weights for M-1 standard ball ammunition and the small caliber rounds would be about 1.6:1.

~~SECURITY INFORMATION~~  
~~SECRET~~

SECURITY ~~SECRET~~ INFORMATION

Unclassified

around the point of aim which would tend to maximize hit probability on the human-target shape.\*

As shown in the Appendix, a cyclic or salvo-type hand weapon would materially increase the effectiveness of aimed fire among the infantry. Although not all possibilities in pattern dispersions and numbers of rounds were analyzed, it appears that the best design (for the greatest practical gains) is one using the four-round salvo with 20 in. spacing among rounds at 300 yd range. The development of a salvo weapon having these characteristics represents an ideal toward which effort might be directed; it is not suggested that this is the only solution.

By considering the need to maintain minimal logistic requirements (number of rounds) and minimum weight, a weapon which conformed to the principle of this design would tend to optimize the military effects of a fire arm, per se. To add to these gains materially, an impractical number of rounds per salvo or burst, or an entirely different weapon would be required.\*\*

From the analysis of the dispersion of shots fired at various ranges, it was possible to calculate the relative effectiveness of a hypothetical new type, salvo automatic weapon, which was assumed to differ from the M-1 rifle only in the manner in which the missiles were projected. Examples of the effectiveness of four- and five-round salvos with 20 in. spacing among rounds at varying ranges are given in Figs. A41 and A42. It will be noted that a four-round salvo of 20 in. spacing at 300 yd would more than double hit effectiveness at this distance. Coincidentally, this increase, through a design change alone, would raise the performance of common marksmen using the salvo weapon to the level of expert riflemen using the M-1.

From this analysis of marksmanship and its relation to a given weapon, it is concluded that: (a) The marked decrease in

\*The analysis (Appendix) suggests that the human target is represented reasonably well by a circular shaped target. Since the average projected area of the body in combat is less than 2 sq ft<sup>3</sup> and a man is about 20 in. wide, the average human target is thus more nearly represented by a rectangle approximately 12 in. x 20 in. if the profile of the head on the shoulders were not considered. Considering the head, however, the average human target in combat does approximate a circle.

\*\*A hand weapon could be designed like a Very pistol and project small fragmentation shells which could be directed at the enemy in much the same way as grenades. By using the new principle of controlled fragmentation shells and employing some unique time fuze, it might be possible to reach a level of true maximum effects for fire arms. The problem would be connected with the fuze and not the launcher if missile bursts were to be controlled over the heads of the enemy. Such a weapon would require considerable technical development, involving, probably, a longer range program than a pattern-dispersion-type fire arm. Any contemplated plan for proceeding with the development of fragmentation hand arms should cause the dispersion weapon to be an intermediate step in the developmental chain.

Unclassified

SECURITY ~~SECRET~~ INFORMATION

~~SECRET~~ INFORMATION  
#18467

hit probability occurring between 100 and 300 yd suggests that significant improvement in effectiveness at these ranges cannot be achieved by increasing the ballistic accuracy of the weapon: aiming errors are too great to be compensated by any improvement in the accuracy of the rifle alone. (b) A cyclic or salvo automatic weapon could compensate largely for these aiming errors if the missiles were projected with a dispersion pattern designed to maximize the probability of a hit on the human target at ranges which most frequently recur in combat (up to 300 yd).

#### Full-Automatic Fire

The last conclusion prompted an examination of the operational performance of current models of fully automatic rifles to determine whether these desirable characteristics obtained. Two questions were salient: (a) As the fully automatic rifle is ordinarily aimed and fired, what is the nature of the shot dispersion from short bursts? (b) Does automatic fire in short bursts increase the probability of a hit on a man-size target, especially at ranges of 100 to 300 yd?

To answer these questions, tests were arranged at Fort Benning, Georgia, in which both expert riflemen and marksmen used current models of full automatic rifles. Type E silhouette targets were mounted in front of six by six-ft target screens. The first firing serial was at 100 yd using controlled bursts of five rounds each. Never did more than one round hit the target or screen from any of the short bursts, and consequently no information could be obtained at 100 yd on the nature of the dispersion pattern. To obtain more than one strike on the six by six-ft screen, the range had to be closed to 50 yd. At this short range it was noted that the man-silhouette target in front of the screen was not hit more than once from any burst. Since single round firing with the M-1 rifle at 50 yd yields a probability of hit of near unity, the effectiveness of automatic fire at such short ranges was of no interest.

The results of these trials (although preliminary) strongly suggested that the emphasis and impetus currently being placed by the US and other NATO countries on the development of fully automatic hand weapons should be questioned on the basis of actual military requirements for the automatic feature. ORO plans to make further tests\* of infantry weapons and some of these tests will include further work on shot dispersions of

\* It is planned to establish a tactical research laboratory at Fort Benning, Georgia.

Unclassified

~~SECRET~~ INFORMATION

SECURITY ~~SECRET~~ INFORMATION

Unclassified

infantry hand arms. However, any work bearing on the establishment of military requirements for weapons, especially automatic hand arms, should provide operational data upon which decisions can be made. In this connection, it might be pointed out that the tests on automatic rifles conducted at Fort Benning, Georgia, do not constitute the type of weapons evaluation from which such requirements can be established. In the reports of these tests," the weakness of automatics from an operational effectiveness standpoint was not revealed, and it is unfortunate that such large-scale trials should not have been designed scientifically to produce data upon which such facts might be determined. Any comparison of automatic and semiautomatic weapons should be designed to determine military effectiveness by relating hit effectiveness with fire power, to include rate of expenditure.

From the preliminary, yet informative, tests conducted by ORO on automatic hand arms it may be stated that:

1. Regardless of the skill of the rifleman, only the first round in a short, fully automatic burst can actually be directed at a point target.

2. At normal battle ranges, all shots after the first fall off a man-size target in an approximately linear pattern, the progressively greater departures\* depending in magnitude upon the characteristics of the weapon and the manner in which it is held.

3. At all common battle ranges, with present hand-held automatics, the strike dispersion is so great that moving the center of impact for the burst to the center of the target would not increase the number of hits.

4. Even at much reduced ranges, where more than one hit from a short burst is scored on a man-size target, the use of a burst can be justified only in a limited sense, since at these ranges single rounds (semiautomatic) have a probability of near unity of striking the target. It follows that reducing the range does not increase the probability of hitting with automatic fire,\*\* but only of obtaining multiple hits. Moreover, when at ranges of 50 yd or less, multiple hits become probable, the

\*The rifleman, by a more or less difficult compensating effort, may exert a type of control. Such control is in itself erratic and is not noticeable before 5 - 10 rounds have been fired, according to the cyclic rate of the weapon.

\*\*This result is inconsistent with current rifle design, which provides a high rate of fire in an effort to increase the number of targets hit, as compared with, say, the model 1903 rifle. Thus, automatic fire is not to be justified on the basis of an increased probability of obtaining a hit on separated man-size targets.

Unclassified

SECURITY ~~SECRET~~ INFORMATION

lethality of the burst increases much more slowly than does the number of hits (see section on lethality).

5. The full automatic feature of current infantry weapons is valueless from the standpoint of increasing the number of targets hit when aiming at separated man-size targets.\*

#### Wound Ballistics: Missile Caliber, Mass, and Velocity

Wound ballisticians have recently determined that the "wounding power" or damage capability of a missile is more nearly proportional to the cube of the velocity than the square.<sup>12</sup> A reasonable (and acceptable) measure for wound severity is the maximum volume of the temporary cavity produced in the tissue by a penetrating missile. It has been found, for example, that the effect of increasing the velocity of a small caliber missile more than compensates for the reduced mass. Recent work<sup>13</sup> has shown that, if extreme ranges are not important, a smaller caliber bullet than the present .30 cal US military standard might well be used. Moreover, evidence shows that at common ranges, .22 cal bullets can produce wounds of measurably greater severity than .30 cal bullets striking with the same velocity, providing these velocities at target are greater than a certain critical value.

Although more extensive work will be required in investigating the effects of nose shape, weight, and other factors as they affect flight characteristics and wounding ability, it has been established that smaller bullets can be used to produce battlefield physiological effects at least equivalent to those of the present standard .30 cal. Substantial logistics savings would also accrue from the introduction of substantially lighter and less expensive cartridges, although actual savings cannot be expressed quantitatively until further research indicates the most practical weight and shape of bullet to employ. The areas of incomplete research should be investigated at the Biophysics Laboratory, the Army Medical Center, Edgewood, Maryland, where facilities and skilled personnel offer the opportunity to advance knowledge in this field in a reasonable length of time and in an important way.

\*During the course of this study, the author considered the various possible uses of present automatics in combat where the automatic feature (and the wide dispersion of rounds) would be militarily useful. Discussion with experienced infantry combat commanders and other military specialists led to the conclusion that although the feature was useful in tight, close-in positions, usually another weapon (e.g., a grenade) could be used to greater advantage than could a burst from an automatic. Also, it was indicated that, for the average rifleman, such occasions were rare and did not constitute a basis for justifying the feature.

Unclassified

Quite apart from the idealized concept of a salvo weapon, sufficient evidence is at hand to be quite certain that a light, high-velocity, small caliber rifle could be designed for military use and could fulfill effectively the role of a general purpose, lightweight hand arm.

In a recent study<sup>14</sup> conducted by D.L. Hall of the Terminal Ballistics Laboratory, Aberdeen Proving Ground, a theoretical comparison of the effects and military usefulness of various calibers of rifles shows that, when the combined weight of weapon and ammunition is held constant to 15 lb, the over-all expected number of kills for the .21 cal rifle is approximately 2.5 times that of the present standard .30 cal rifle. When compared to M-1 ammunition, a .21 cal missile of high velocity (about 3500 feet per second muzzle velocity) creates equal or greater damage than the standard .30 cal missiles at ranges up to 800 yd. This evidence, combined with the work of Project BALANCE (ORO) on ranges of visibility, marksmanship, and actual operational needs, lends considerable support to the major conclusion that lighter hand weapons of smaller caliber may well be provided without losing military effectiveness, while offering both impressive logistical gains and improved operations.

In addition to these gains, the advantages of low-recoil effects offered by the smaller caliber weapons would be reflected in improved skill in the use of the weapon by allowing a higher rate of single-round aimed fire. Such weapons would also be much less fatiguing to handle. Since recoil of a small caliber weapon would be less than that of present weapons, the dispersion of rounds in a short, fully automatic, burst could be considerably less than the dispersion of current models. This important characteristic, yet to be determined by actual trial of small caliber automatics, might possibly be the most practical solution to the problem of developing an automatic fire arm which will project missiles in a burst such that the dispersion of rounds, at ranges up to 300 yd, would approach the ideal dispersion for maximum effects as indicated in the Appendix.

The studies and experimental development work\* currently being undertaken by the Ordnance Corps at Aberdeen Proving

\*Discussion with G. A. Gufstafson of the Small Arms Section of BRL indicated that it is feasible to design small caliber, high velocity, automatic rifles, which would exhibit short-burst dispersion patterns at ranges up to 300 yd, tending to approach dimensionally the ideal patterns outlined in the Appendix.

Unclassified



~~SECRET~~  
#18471  
Unclassified

Ground should be encouraged to proceed toward a rifle development which will fulfill these important military characteristics. Although such a light weapon would not compensate for human aiming errors when fired semiautomatically, it is quite possible that automatic fire in short bursts at common battle ranges would produce dispersion patterns commensurate with the requirements of the idealized salvo weapon. In particular, the low recoil of a small caliber rifle offers the chance to employ a muzzle compensator with significant effects, lending added promise to a satisfactory development. If the development of this light, high velocity weapon could proceed to include the ideal salvo principle, obviously a truly effective hand arm could be provided.

## LETHALITY

### Weapons in General

The history of the development of weapons and tactics shows an interesting process of self-adjustment. It has been found, from an examination of many campaigns from Marathon to Korea, that battles are no more bloody now, despite vastly "improved" weapons, than they were in the days of the short sword: the casualties incurred per number of men engaged per unit of time remains about constant.\* In fact, it may well be that the sword is much more lethal than conventional weapons because it can be directed with more control at the vulnerable areas. It remains to be seen whether the tactical use of atomic and new CBR weapons will alter this trend.

The explanation for this apparent constancy in the intensity of battle effects seems to be related to the compensating changes in tactics which each new weapon introduces. Most advances in weapons either increase the distance over which a blow can be delivered (improved launcher) or increase the lethal radius or radius of effect (improved missile), or both. The ratio of the lethal area to the concentration (or density) of enemy targets appears to have remained constant. Since logistics costs have markedly increased since the early wars, war itself has become vastly more costly in terms of the effect-cost ratio, yet little if any more effective in terms of personnel casualties per unit time or per unit effort.

\*From an unpublished ORO study.

~~SECURITY SECRET INFORMATION~~ #18472

Although these are measures of gross intensity for war (total casualties only), it is interesting to note that severity of weapons as measured by their lethality has not changed, at least in the past century. If the lethal indices of weapons (also a constant) could be raised, efficiency and effect might well be improved materially, and no compensating tactical adjustment would be practicable. It is believed that the means for doing this are at hand, and, with special reference to one weapon (the infantry hand arm), an estimate is made in a following section of expected results if bullet lethality were increased, as seems technologically feasible.

### The Rifle

The lethal index of a weapon corresponds roughly with tactical effectiveness since it refers to those wounds which are speedily lethal, the condition of which cannot be reversed by medical intervention. Since, by this definition, "lethal" effects result in death very quickly (or death is assured), the lethal index is a measure of tactical effect. Therefore, in the forward areas of the combat zone, where bitter hand-to-hand fighting occurs, there is no sound basis for arguing against the merit of disposing of the enemy in the shortest possible time by inflicting maximum physical trauma. For the infantry hand arm, the infliction of severe wounds, that are immediately incapacitating, is important.

As stated earlier, the lethal index of the rifle exceeds 30 percent when hits at all ranges are considered, and, with the exception of the machine gun, it is the most lethal weapon of all conventional missile projecting ground arms.

### Comparison of Lethality of an Ideal Dispersion Automatic with M-1 Single-Shot Fire

From Table A9 and Fig. A40 in the Appendix, it is possible to estimate the lethality of an ideal dispersion weapon at the various battle ranges and compare these effects with those of the rifle. Because no exact information exists concerning the vital area complex of the body or the effects on lethality of multiple hits, it was necessary to assume that all bullets from a salvo, or burst, are independently lethal and that multiple hits are incurred at random relative to the vulnerable areas. Obviously, this assumption ignores the fact that physiological effects of multiple wounds are cumulative (shock, exsanguination, and the like), and that hits

~~SECURITY SECRET INFORMATION~~

~~SECRET~~  
Unclassified

from the ideal dispersion weapon follow a pattern design and do not, therefore, strike at random. Since cumulative effects of multiple wounds add to lethality, and since any lack of randomness in the hits may or may not favor the probability of striking mortally vulnerable areas, the estimates given may be strengthened perhaps by the compensating effects of these two indeterminate factors. For each weapon, it is assumed that the lethal probability of a bullet hit is 0.3.

From Table A9 (Appendix), the lethality for the dispersion weapon (five-round salvo pattern) can be estimated for each category of single and multiple hits for each range. An example of the method used is given for a range 200 yd:

- Probability of kill per bullet hit,  $P_l = 0.3$ ;
- Probability of not killing per hit,  $P_s = 0.7$ .

Thus, for each category of possible hits from a five-round salvo:

Hits	$P_s$	$P_l$
1	0.700	0.300
2	0.490	0.510
3	0.343	0.657
4	0.240	0.760
5	0.168	0.832

For range 200 yd (Table A9), the probabilities of obtaining exactly 1, 2, 3, 4, and 5 hits with the five-shot patterns are:

Hits	1	2	3	4	5
$P_h^{**}$	0.388	0.122	0.284	0.0580	0.000

therefore,

$$P_h \times P_l = 0.116 \quad 0.0622 \quad 0.187 \quad 0.0441 \quad 0.000$$

At range 200 yd, the probability of killing an enemy per burst is the sum of the lethal probabilities = 0.409.

For single rounds from the M-1 rifle at 200 yd, the kill probability is 0.135 ( $P_h = 0.45$  and  $P_L = 0.3$ , Fig. A40). In

\*The lethal index of the rifle bullet exceeds 30 percent. It is assumed that the smaller caliber bullet for the new weapon would be equally lethal since it will have a wounding capability equal to or greater than the M-1 at the ranges involved.

\*\*The variations noted in the probabilities for obtaining more than one hit are due to the shape of the human target as it affects a strike of two or more hits from the dispersion pattern.

~~SECRET~~  
Unclassified

Unclassified

this way, the lethality of the two weapons may be compared as shown in Fig. 5.

The curves giving the lowest lethal limit\* and the probable upper limit for the dispersion weapon show that a considerable relative increase in lethality over the rifle may be expected through the use of the dispersion weapon for ranges beyond 100 yd. The theoretical upper limit would

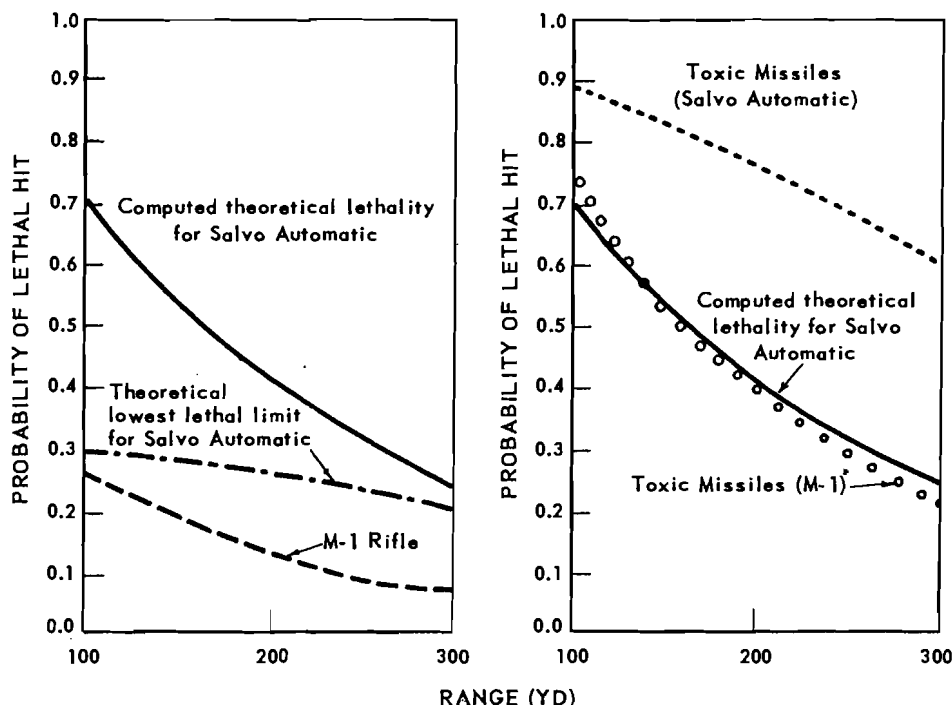

Fig. 5—Comparison of lethality per aimed shot or burst for the M-1 Rifle and the Salvo Automatic.

exceed the M-1 rifle by about a factor of three, if the basic assumptions used in the estimates can be accepted as reasonably valid. Obviously, at ranges less than 100 yd, the dispersion of the rounds in the salvo pattern becomes greatly diminished as range is decreased. Consequently, the lethal effects will not differ greatly from the single-round rifle especially when zero range is approached. This variation in pattern size with range points up the difficulty of attempting to assess comparative lethal effects at the shorter ranges and also reveals the weakness of the estimates at the greater distances.

\*Calculated on the basis of at least one hit (Table 9).

Unclassified

Unclassified

Quite apart from any consideration of or comment upon, the protocols and conventions according to which the rules of land warfare have been codified, it is proper to estimate in a purely physical way the results of the use of toxic missiles in such weapons.

Consequently, Fig. 5, the two weapons have been compared for a use of toxic missiles.\* It is interesting to note that, by the addition of toxic missiles to the M-1 rifle, the lethal effects thus produced are about equivalent to the theoretical upper limit on physical effects given for the dispersion weapon. On the other hand, the employment of toxic missiles in the dispersion weapon offers, in toto, still greater gains; such effects would constitute an order of lethality not achieved by any missile projecting ground weapon yet devised.

### Can Lethality Be Increased?

The lethal indices of present weapons cannot be improved materially (if at all) by increasing the effective "hitting power" alone, since the mortally vulnerable regions of the body set a limit to the gain. However, by combining chemical toxicants with physical missiles, it is possible to make the entire body vulnerable by utilizing the circulatory system as, in effect, a "missile track" which produces certain lethal effects. Rather than 30 percent fatalities derived from bullet hits, this procedure would cause the body to become mortally vulnerable to virtually all of the hits received. Quite apart from the relative increase in lethality brought about by the design of a dispersion weapon as shown in the preceding section, the following analysis on toxic missiles has been included to show the nature of the relative gains to be expected in the dispersion weapon if toxicants were introduced in future warfare. The gains to be described are purely speculative and would provide additional gains only to the physical lethality of the dispersion weapon. Although not a necessary adjunct, should toxicants be employed, the smaller missiles suggested for the new weapon would be more efficient vehicles of the agent than the larger .30 cal bullets.

Developmental work in the field of toxic missiles is reasonably complete and shows that up to 90 percent of hits from agent-loaded bullets at common ranges may be expected to

\* As indicated later, a lethal probability  $P = 0.9$  was assigned to each toxic loaded round. The curves were established by taking the product of the probability of a hit and the probability of lethality for toxic missiles. (See Table A9 and Fig. A40.)

Unclassified

~~SECRET~~  
#18470

incapacitate in a matter of minutes and bring about death regardless of the region of the body struck.<sup>15</sup> The agent used is stable (in storage, it is as stable as any other part of the round); it can be manufactured in large supply at low cost; its toxicity is about as high as any substance known. The physiological effects produced by the agent are similar to the G-agents: death is rapid and the course of the effects is violent. The progress of the physiological symptoms is demoralizing to witness; thus real psychological effects not normally characteristic of weapons design are added.\*

Since it has been found that small missiles (such as .22 cal) are more efficient vehicles for such toxic agents than are the larger calibers,<sup>15</sup> the application of toxic missiles to a small caliber hand weapon as herein proposed is particularly adaptable. To the increase in hit effectiveness brought about by the use of the dispersion weapon, an impressive gain in the lethality of these hits might be added. Thus would be achieved a genuine innovation in a weapons system which has exhibited through history a constancy in lethal effects.\*\*

Data from the last two World Wars show that for ground troops the ratio of killed to wounded (all ground weapons) was, for both periods, about 1:4.1. About 20 percent, then, are killed in action.<sup>1</sup> With the single addition of toxic bullets for small arms to the whole weapons system, the ratio of KIA to WIA in these past two wars would have been raised from 1:4.1 to about 1:2.1, or, on the average, the lethal index of all weapons would have increased 12 percent, from 20 percent to 32 percent.\*\*\*

Although these figures are crude estimates of the gross or over-all gain which might be expected by the employment of toxic missiles, it is probable that the gain would be a

---

\* Apart from flaming weapons, ordnance development has not taken advantage of possible designs to produce fear in the enemy as well as physical damage. Toxic missiles do offer the possibility of combining the elements of physical and psychological trauma for maximum effects. [See also ORO-R-3, Appendix H, (SECRET)]

\*\* Against toxic missiles, certain defense measures could be adopted. A suitable antidote could be carried by each man in the form of an ampule and injection could be performed through the clothing using the same methods as planned for defense of G-agent poisoning. Also, if small caliber missiles were used and the bullets were designed to encourage rapid disintegration in the wound track, light (plastic) armor might be used. In both of these areas of defense, the Soviet may be weaker than the US in the initial phases of toxic missile employment but it is certain that, like all other technical advantages in warfare, a process of neutralization will occur whereby neither side has a material advantage because of the equalizing effects of the defense measures which both sides eventually adopt. Furthermore, speedy retaliation in kind should not be difficult for either side.

Enemy reactions must be anticipated.

~~SECRET~~

strategic one rather than tactical. In an ORO analysis of battle casualties as to their period of non-effectiveness,<sup>16</sup> data indicate that ideal toxic missiles would do little further to reduce enemy strength during any battle situation but may exert considerable influence over an extended campaign. Finally, it must be remembered that only by improving the hit capability of the weapon, as herein proposed in the dispersion weapon, would one expect maximum gains in the tactical situation if toxic missiles were introduced.

## THE DISPERSION WEAPON

### Basis of Issue (T/O&E)

It is to be emphatically stated that the new type hand arm, as proposed in this study, should not entirely replace the longer-range rifle in the unit organization. In most tactical situations there is a definite requirement for sniper (highly specialized) fire. It is also important to maintain a degree of versatility responsive to the dynamic tactical situation. Consequently, it is believed that the precision-aimed, long-range rifle must be retained for that limited but existing employment which its design characteristics actually fit. Limited knowledge of sniper fire indicates that at squad level it is not employed frequently in the fire fight but has an important role in the defense or in the less fluid conditions (maneuvering for build-up, and so forth) preceding a hot action. As far as can be determined by questioning combatants, the ranges of sniper fire are mostly within the tactical damage range of the small caliber, high velocity missiles (i. e., up to 800 yd). This suggests the possibility of using weapons of the same caliber as the general purpose hand arm, but designed for precision, long-range use. However, the whole question of sniper fire in battle is yet to be analyzed from an operations point of view; until this is done little can be said concerning weapons requirements for specialists in this role.

---

\*\*\* About 20 percent of the total hits of these past wars have been bullet hits. Of those hit, roughly 30 percent are KIA. (On limited knowledge of enemy Japanese rifles of WW II.) Thus, toxic bullets would result in 90 percent KIA among those hit and increase the lethality of the bullet by a factor of 3. Thus the total killed by bullets would increase from  $20 \times 0.3 = 6$  percent to  $20 \times 0.9 = 18$  percent. The total killed (all weapons) would then increase from 20 percent to 32 percent of those hit. (Note: The figure, 6 percent, for fatal bullet hits may be low for small arms fire; Tribby's analysis of 1,000 KIA in the ETO attributed about 11 percent of those killed to small arms fire.)

~~SECRET~~ INFORMATION

Unclassified

The question of a general purpose hand arm is not one of supplanting a long-range precision arm, but rather of replacing a certain number with a different weapon, each type having its own proper and effective tactical application.

It is believed that a practical and useful beginning can be made in deciding upon the optimum ratio of short-range hand arms to long-range precision rifles by noting the figures for ranges of engagement which have been presented earlier. On the average, it has been found that 70 percent of the ranges over which a man-size target is visible to a defending rifleman lie within 300 yd. Since the short-range weapon will be designed according to specifications for maximum effect up to 300 yd, it may be suggested that 7 in every 10 infantry hand weapons should have the characteristics desirable for short-range use. Although this target-visibility criterion, employed to set an upper limit to the range of engagement, ignores certain variables within the small infantry unit which bear on control and communications as well as many of the problems of musketry and maneuver, it may be received as a tentative and preliminary basis for issue.

Another approach to the determination of an optimum ratio for hand weapons is to consider the aptitudes of enlisted men normally received from the manpower pool. From experience at Fort Benning,\* the development of no more than two expert riflemen per squad may be expected from the normal recruit stream without special training. Unless present training schedules and methods are altered to permit improvement in marksmanship skill, this tends to set an upper limit on the number of highly skilled riflemen that it is feasible to assign to the squad from the standpoint of natural aptitudes available to the Army, and of the training effort.

The figure(two experts per squad) is consistent, however, with that already given as the apparent actual requirement. This does not mean that it would not be desirable to have much higher performance in marksmanship among all the men in the squad; the suggested assignments for experts merely emphasize the operational need for at least two experts per squad if training is unavailing in raising present standards of performance.

\*It was not possible to obtain data from the AGO, G-3, or OCAFF on the number of enlisted men who could be expected on the average to pass as experts. In private communication with Fort Benning, the Infantry School has indicated that about 10 percent of the men receiving marksmanship training could be expected to pass as experts by known distance range firing standards.

Unclassified

~~SECRET~~ INFORMATION



To arrive with assurance at an optimum ratio, much more knowledge of small unit operations in combat would be required than is now known in ORO or elsewhere. Determinations at a "tactical laboratory," such as ORO is eager to see established at Fort Benning, could contribute much to the solutions.

### Training

The increases in effectiveness which have been proposed in this analysis all follow from innovations in design of the weapon for the purpose of overcoming deficiencies in skill or training and for adapting the weapon to the nature of its actual operational employment. Since there is no reason to suppose that the new weapon would be characterically unlike the present rifle in its method of operation, no increased demands for training time or facilities are visualized. In fact, the short range of the weapon offers a chance for considerable reduction in weight and for less precision in working parts. Consequently, development of a lighter weapon, with low recoil, should facilitate training in its use.

Also, it is felt that men would react favorably to a weapon which increased their own marksmanship performance since it would add to their confidence in being able to hit the enemy at ranges where M-1 rifle fire is comparatively ineffective. It does not seem reasonable to assume that a man's confidence in his weapon would be affected adversely by a design which increased his chances of hitting the enemy and therefore increased the probability of his own survival.

In connection with present marksmanship training, the results given in the Appendix suggest strongly that considerable improvements are needed if skills are to approximate the precision capabilities of the M-1 rifle. An examination of the current basic training program shows that 76 hours are allowed for marksmanship training with the rifle, of which only 48 hours are involved in "wet" exercises, that is, actual range firing of the weapon.<sup>17</sup>

In the 48 hours of training, each man fires at least 400 rounds, which indicates roughly the total amount of time spent in the actual employment of the rifle. Any question of the adequacy of this training program could only be settled by field tests designed to determine the best methods and the time required to produce optimum results among men in their marksmanship skills. As shown in the Appendix, it is not likely that training alone could be effective in materially raising the standards of all men to exceed the level of expert performance indicated by the Belvoir

Unclassified

~~SECRET~~ #18480

Unclassified

tests. Significant gains in man-weapon effectiveness are to be obtained only by combining improvements in weapon design with good training. By the adoption of design principles in a hand weapon, as proposed in this study, an opportunity is offered to realize gains of considerable magnitude.

### Design Feasibility

No insoluble problems appear to be involved in the engineering of a weapon possessing the recommended characteristics. To accomplish ideal dispersion in an automatic hand arm, as idealized in the Appendix, many design difficulties will stand in the way of preserving desirable military characteristics such as light weight, durability, reliability, automatic loading, and other factors. A salvo-type automatic which projected volleys of rounds to form the desired pattern at the range giving maximum hit effectiveness probably would represent the best type of design for deriving the greatest gains. This would entail designs which include the multi-barrel principle, high cyclic rate single-barrel types with a design feature for allowing the barrel to nutate at the muzzle on recoil for controlled dispersion, frangible missiles, aerodynamically controlled missiles, compensators, deflectors, and the like, all of which present a variety of engineering difficulties to be overcome before the weapon would function satisfactorily. The point of chief concern, however, is to strive for the attainment of the pattern dispersion principle so that the greatest possible gains can be derived, and in the striving, let the engineering difficulties argue for themselves.

In studying the design problems, it was apparent that the smaller caliber weapon, with its bullets of smaller mass, would have considerably less recoil than present automatics, and that the reduced dispersion of a burst, along with the employment of a muzzle compensator, should have significant effects in reducing muzzle "walk-off." As stated previously, it may well be that a light automatic of small caliber (in the region of .20 cal) would produce dispersions of rounds in short bursts which are not incongruous with the pattern dispersions specified in the Appendix. At least the tendency would be a significant reduction in dispersion as compared to present automatics with their high recoil effects. Such reduction may be sufficient to regard the dispersion as approaching the optimum requirements.

Considering all factors, this approach to the problem appears to be straightforward, practical, and relatively simple, and it offers promise of fulfilling the desirable optimum dispersions

Unclassified

~~SECRET~~ INFORMATION

~~SECRET~~  
Unclassified

for maximum hit effectiveness. Tests on prototype models of new weapons of small caliber should be made to determine the practicality of this approach to the problem.

#### A THEORY FOR DETERMINING RELATIVE EFFECTIVENESS OF DIRECT FIRE WEAPONS

The analysis would not be complete if advantage were not taken of possible valuable theoretical applications which may be made using the two major parameters given in the analysis of the man-rifle system. These parameters relate to the probability of seeing a man target on the battlefield and the probability of hitting the target with aimed fire.

To test an hypothesis, according to which effectiveness might be evaluated, use was made of battlefield visibility data for the area of Korea where ranges were known for a small sample of rifle bullet hits among members of the Turkish Brigade.

#### Method Used

The method which has been used in estimating the expected distribution of hits as a function of range may be open to serious question because of the possible weakness of the assumptions made about actual rifle operations. Although the need was recognized for more adequate knowledge of the factors which exert a major influence on aimed rifle fire, it was felt that the data on visibility and hit probability might be useful for computing the expected distribution of hits as a function of range for different weapons. As shown in Table 1, the probability product of the hit data and of the visibility data for each range interval yields predictions on the relative distribution of hits, if one assumes expenditure proportional to targets seen and targets seen proportional to the map measurements on visibility.

In Table 1, the data given for Ps are the fraction of all cases where a man can be seen continuously in the 50-yd interval. Employment of the data sets up a model which visualizes the enemy approaching a defender who fires on the enemy when he first appears. The results of the repetition of many cases of this simple dual situation should permit prediction of the type of distribution of hits as a function of range, for aimed rifle fire over the Korean terrain. While it is possible to calculate the number of hits to be expected as a function of range using column 4 of the Table, the calculated number of hits cannot be

Unclassified

~~SECURITY SECRET INFORMATION~~

Unclassified

compared with the observed number because the sample of combat data did not provide information on the total number of men involved or the expenditure of rifle ammunition. For this reason, the percentage distribution of expected hits was compared to the observed distribution.

TABLE 1  
COMPUTED DISTRIBUTION OF HITS AS FUNCTION OF RANGE R

Range Interval, yd	$P_s^a$	$P_h^b$	$P_s \times P_h$	$P_s \times P_h$ , Normalized	Accumulated "Expected Fraction of Hits"
0-49	0.360	1.00	0.360	0.457	1.000
50-99	0.254	0.93	0.234	0.297	0.543
100-149	0.162	0.76	0.123	0.156	0.246
150-199	0.070	0.54	0.037	0.047	0.090
200-249	0.047	0.38	0.018	0.023	0.043
250-299	0.028	0.28	0.008	0.010	0.020
300-349	0.024	0.22	0.005	0.006	0.010
350-399	0.016	0.17	0.003	0.004	0.004
Totals			0.788	1.000	

<sup>a</sup>Probability of seeing target within each interval.

<sup>b</sup>Probability of hit.

In Fig. 6, the distribution for the calculated fraction of hits corresponds roughly with the distribution of actual hits in combat in Korea.

As a matter of interest, the M-1 rifle and the five-round salvo type weapon were compared in this way for the two extreme types of terrain, Class A and Class C. The expected distribution for hits from both weapons at ranges greater than R for the Korean terrain and for the Normandy terrain is given in Fig. 7. Since these distributions do not show the relative effectiveness of the two weapons, the same model was used to provide an indication of the merits of the salvo weapon over the rifle as terrain influences effectiveness.

In this instance, as shown in Table 2, the hits were calculated on the basis of 100 shots fired for each weapon at man targets distributed over terrain in accordance with the distribution given for  $P_s$ .

Unclassified

~~SECURITY SECRET INFORMATION~~

Unclassified

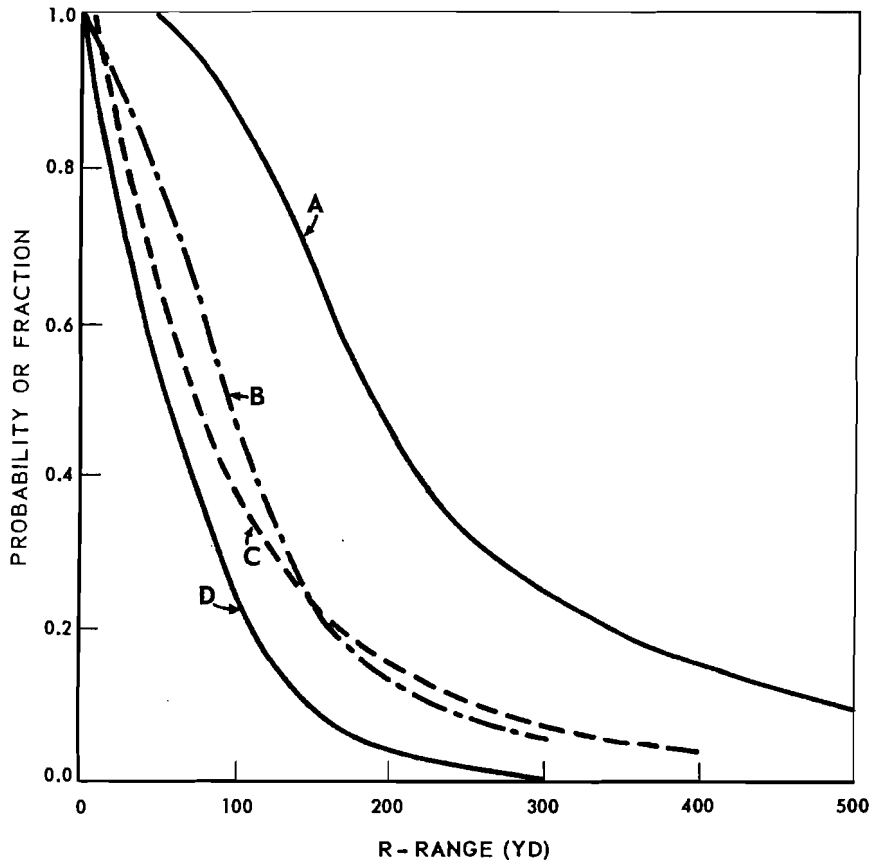

Fig. 6—Rifle marksmanship, battlefield visibility, and hit probability in combat. A:  $P_h$ , probability of hitting man-target as function of range; B, observed fraction of hits occurring at ranges greater than R; C, probability of seeing target at ranges greater than R ( $1 - P_s$ ); D, computed fraction of hits expected\* to occur at ranges greater than R ( $P_s \times P_h$ , where  $P_s$  is converted to frequency of visible areas occurring in each 50 yd interval, and where  $P_h$  is averaged in each interval by assuming the mean P value).

\* Assumes expenditure proportional to targets seen and targets seen proportional to  $P_s$ .

Unclassified

~~SECRET~~ #18484

Unclassified

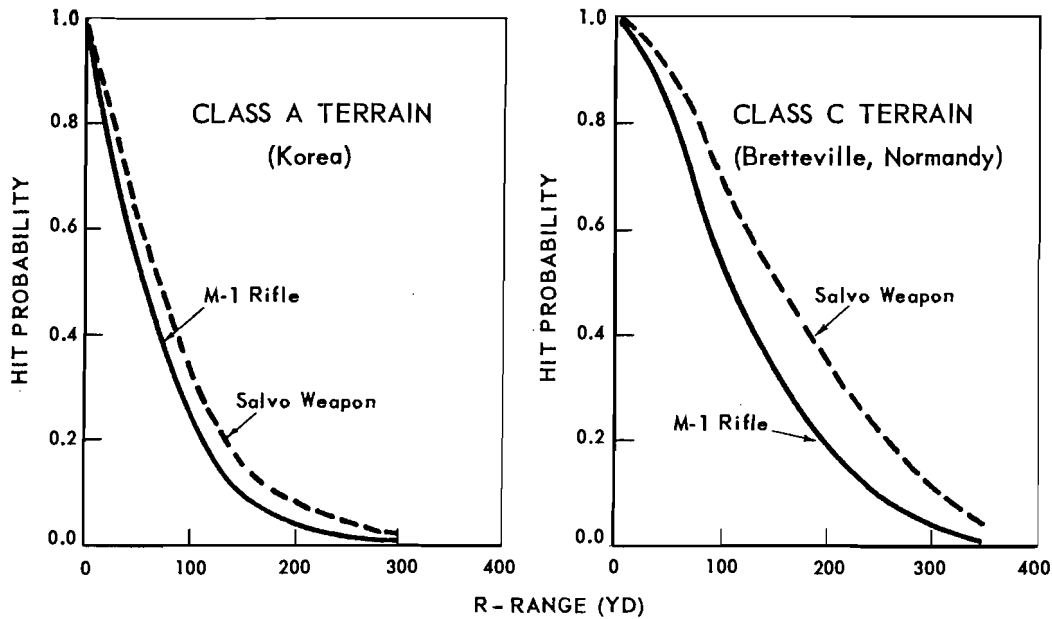

Fig. 7—Theoretical distribution of hits as function of range for M-1 Rifle and a Salvo-Type Hand Weapon for Class "A" and "C" Terrains.

TABLE 2

RELATIVE EFFECTS OF M-1 SINGLE-ROUND FIRE AND SALVO FIRE AS FUNCTION OF RANGE FOR TERRAIN TYPES A AND C

Range Interval, yd	Ps <sup>a</sup>		Ph <sup>b</sup>		Expected Hits		Ps × Ph, Normalized	
	Class A	Class C	M-1	Salvo	M-1 Class A	Salvo Class A	M-1 Class C	Salvo Class C
0-49	0.360	0.05	1.00	1.00	37	37	9	9
50-99	0.254	0.10	0.93	0.99	24	26	16	17
100-149	0.162	0.09	0.76	0.96	12	16	12	15
150-199	0.070	0.09	0.54	0.89	4	6	8	14
200-249	0.047	0.09	0.38	0.81	2	4	6	12
250-299	0.028	0.06	0.28	0.71	1	2	3	9
300-349	0.024	0.06	0.22	0.60	1	1	2	6
350-399	0.016	0.04	0.17	0.49	0	1	1	3
Totals	0.961	0.58			81	93	57	85

<sup>a</sup>Probability of seeing target within each interval.

<sup>b</sup>Probability of hit.

Unclassified

~~SECRET~~ INFORMATION

~~SECRET~~

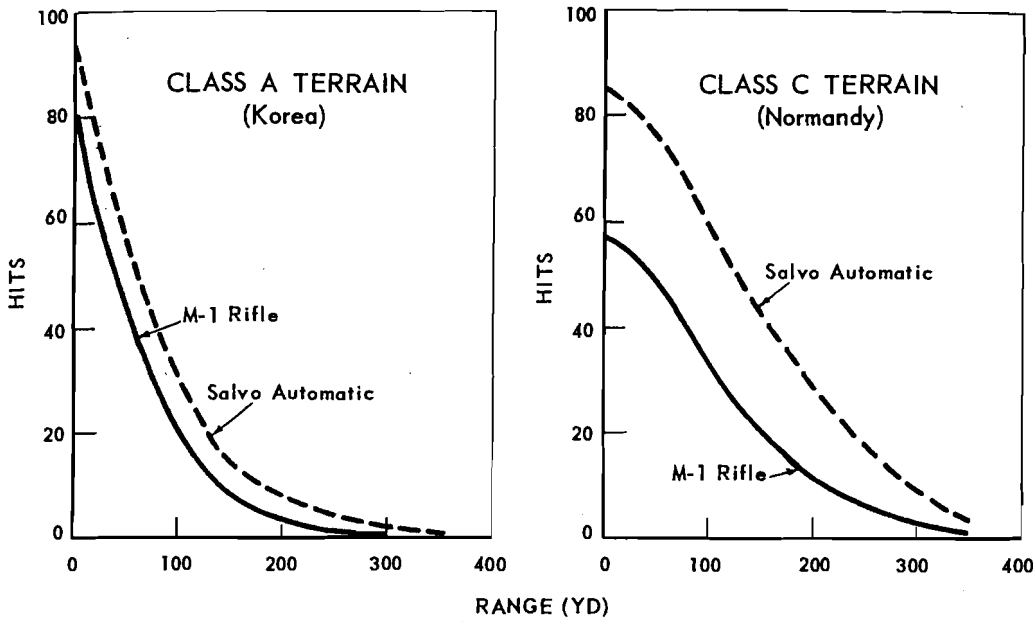

Fig. 8—Relative effectiveness of M-1 Rifle and Salvo Automatic for Class "A" and "C" Terrains.

It will be noted in Fig. 8 that the comparative effectiveness of the salvo weapon is much greater for open terrain types like Class C than for terrain types of Class A because of the greater hit effectiveness of the salvo weapon at the longer ranges. Such information, although only relative, suggests that the dispersion type hand weapon would offer material advantages over the M-1 rifle in areas of combat such as western Europe. On the other hand, the advantages of the new weapon in areas like Korea are not as great and the comparison made in Fig. 8 supports the contention that a hand weapon designed for semiautomatic use in the short ranges and for full automatic use in the longer ranges with controlled dispersion would offer a good solution for the common hand arm.

If theory, as herein presented, can be confirmed by more extensive knowledge of expenditure and ranges of hits incurred in combat by the rifle and other direct fire weapons to include machine guns, recoilless rifles, antitank weapons, and the like, the method would constitute a promising basis for evaluating a balanced weapons system, and T/O&E for units might be established on a quantitative basis.

~~Unclassified~~

~~SECURITY SECRET INFORMATION~~

~~SECRET~~  
SECURITY INFORMATION

Unclassified

## CONCLUSIONS

1. The ranges at which the rifle is used most frequently in battle and the ranges within which the greater fraction of man targets can be seen on the battlefield do not exceed 300 yd.
2. Within these important battle ranges, the marksmanship of even expert riflemen is satisfactory in meeting actual battle requirements only up to 100 yd; beyond 100 yd, marksmanship declines sharply, reaching a low order at 300 yd.
3. To improve hit effectiveness at the ranges not covered satisfactorily in this sense by men using the M-1 (100 to 300 yd), the adoption of a pattern-dispersion principle in the hand weapon could partly compensate for human aiming errors and thereby significantly increase the hits at ranges up to 300 yd.
4. Current models of fully automatic hand weapons afford neither these desirable characteristics nor adequate alternatives. Such weapons are valueless from the standpoint of increasing the number of targets hit when aiming on separated man-size targets.
5. Certain of the costly high standards of accuracy observed in the manufacture of current rifles and ammunition can be relaxed without significant losses in over-all hit effectiveness.
6. To meet the actual operational requirements of a general purpose infantry hand weapon many possibilities are open for designs which will give desirable dispersion patterns (and accompanying increases in hit probability) at the ranges of interest. Of the possible salvo or volley automatic designs, the small caliber, lightweight weapon with controlled dispersion characteristics appears to be a promising approach. (Low recoil of a small caliber weapon facilitates dispersion control.)
7. To create militarily acceptable wound damage at common battle ranges, missiles of smaller caliber than the present standard .30 caliber can be used without loss in wounding effects and with substantial logistical and over-all military gains.
8. A very great increase in hit lethality can be effected by the addition of toxic agents to bullet missiles.

## RECOMMENDATIONS

1. It is recommended that the Ordnance Corps proceed to determine the design or technological feasibility of developing a

Unclassified

~~SECRET~~  
SECURITY INFORMATION



~~SECRET~~  
Unclassified

hand weapon which has the characteristics cited in this analysis, namely:

- a. Maximum hit effectiveness against man targets within 300 yd range. (This does not mean that the weapon will be ineffective beyond this range.)
- b. Small caliber (less than .30).
- c. Wounding capability up to 300 yd at least equivalent to the present rifle.
- d. Dispersion of rounds from salvos or bursts controlled so as to form a pattern such that aiming errors up to 300 yd will be partly compensated, and hit effectiveness thereby increased for these ranges.

2. As one possible alternative to the current "volume of fire" (fully automatic) approach to the problem of increasing the effective firepower of infantry riflemen, it is recommended—subject to tentative confirmation of design feasibility—that a rifle incorporating at least in principle the military characteristics here proposed be manufactured for further and conclusive test.

Unclassified

SECURITY ~~SECRET~~ INFORMATION #18788

Unclassified

## BIBLIOGRAPHY

1. Gardner, John H.; Hitchman, Norman A.; Best, Robert J.  
ORO-R-5: ALCLAD Final Report, Appendix A.  
1 August 1951 (SECRET).
2. Johnson, Ellis A.; Parker, Edward M.; and ORO Staff.  
ORO-R-3: MAID Report, Appendix H.  
21 January 1950 (SECRET).
3. ORO-R-5, Appendix B (SECRET).
4. DeBakey, M. and Beebe, G. Battle Casualties. Springfield,  
Illinois: C. Thomas Co., 1951 (UNCLASSIFIED).
5. Oughterson, Col. A. W. Wound Ballistics Report,  
Bougainville Campaign, 1944 (RESTRICTED).
6. Office of the Surgeon General, Wound Ballistics Survey,  
Korea (15 November, 1950-5 May 1951) (CONFIDENTIAL).
7. AORG liaison Letter, December 1951 (SECRET).
8. Donovan, Grace N. ORO-T-18(FEC): Use of Infantry Weapons  
and Equipment in Korea. August 1952 (SECRET).
9. Kaye, J. D. The Use of Infantry Weapons in Korea.  
ORS/Korea. Report No. 6, 12 March 1952 (SECRET).
10. Bayly Pike, D. F. and Goepel, Charles. ORO-T-161: The  
Effects of Terrain on Battlefield Visibility (SECRET).
11. Army Field Forces. Report of Board No. 3, Project 2231;  
Vols. I and II. Fort Benning, Georgia, 27 October 1950  
(SECRET).
12. National Research Council. Missile Casualty Reports,  
Nos: 1 to 17.
13. Chemical Corps Medical Laboratory. Wound Ballistics of  
a .22 Caliber Brass Scale Model of the .30 Caliber M-2  
Rifle Ball, Research Report No. 94, December 1951  
(CONFIDENTIAL).
14. Hall, D. L. An Effectiveness Study of the Infantry Rifle,  
BRLM 593, March 1952 (CONFIDENTIAL).
15. Army Chemical Center. Reports on Project 4-04-19-001  
(SECRET).
16. ORO unpublished Study.
17. FM-23-5, US Rifle Cal .30 M-1. October 1951 (UNCLASSIFIED).

Unclassified

SECURITY ~~SECRET~~ INFORMATION

~~SECRET~~

APPENDIX

ANALYSIS AND APPLICATION OF  
RESULTS OF RIFLE-RANGE TESTS

Unclassified

Unclassified

APPENDIX

ANALYSIS AND APPLICATION  
OF RESULTS OF RIFLE-RANGE TESTS

CONTENTS

	Page
SUMMARY	49
INTRODUCTION	49
ANALYSIS	50
Objective – Data from Tests – Determination of Means (mpi) and Dispersion (Standard Deviation) – Summary of Means and Standard Deviation – Dispersion as a Function of Range – Systematic Errors in the mpi – Comparison of Observed and Theoretical Distributions of Deviations from mpi – Remarks on the Homogeneity of Results for Individual Riflemen – Remarks on Deviations of mpi from Aiming Point – Comparison of Observed and Theoretical Probabilities of Hitting Target at Various Ranges – Remarks on Results of Firing on Targets Appearing Randomly at Either of Two Ranges.	
APPLICATION	91
Theoretical Probability of Hitting Type E Silhouette Target With a Salvo Pattern – Probabilities for 1, 2, 3, 4, and 5 Hits on Man-Size Target With Five-Shot Pattern Salvo – Comparison of Theoretical Probabilities of Hitting "Average Target" with Single-Shot and Five-Shot Pattern Salvo – Remarks on Significance of Probabilities of Hitting a Target with a Single-Shot and with Five-Shot, Four-Shot Pattern Salvos – Effect	

ORO-T-160

Unclassified

45

Unclassified

CONTENTS (Continued)

of Weapon Dispersion on Probability of Hitting Target. Page

FIGURES

A1-A32. Shot Patterns on Target and Screen, Tests 1 and 2. 52-75

A33. Example illustrating use of probability paper to determine standard deviations and means, whether or not distribution is truncated 76

A34. Observed standard deviation,  $S_T$ , of distance of individual shots from mpi as function of target range, for experts 78

A35. Observed standard deviation,  $S_T$ , of distance of individual shots from mpi as function of target range, for marksmen 80

A36. Distance of mpi from top of target as function of range 84

A37. Distance of mpi from vertical line through target center as function of range; Test 1 85

A38. Distance of mpi from vertical line through target center as function of range; Test 2 86

A39. Probability of expert riflemen hitting Type E silhouette of range 88

A40. Probability of marksmen hitting Type E silhouette target as a function of range 89

A41. Probability of hitting Type E silhouette target with single shot compared with probability of at least one hit with a five-shot pattern salvo; curves based on aiming errors 92

Unclassified

Unclassified

## CONTENTS (Continued)

FIGURES	Page
A42. Probability of hitting "average" target, A, with single shot compared with probability of at least one hit on target with five-shot pattern salvos.	94
A43. Probability of hitting a circular target as function of range for several weapon-ammunition errors	97
<b>TABLES</b>	
A1. Rifle Range Test 1	98
A2. Rifle Range Test 2	99
A3. Rifle Range Test 3	100
A4-5. Comparison of Observed Number of Shots Inside Zones Bounded by Circles of Radii $r_1$ and $r_2$ in., with Number Expected from Bivariate Distribution with Radial Standard Deviation $\sigma_r$ , at four Ranges, R, in yd.	
Test 1 (Ei and Es)	101
Test 1 (Mi and Ms)	102
A6-7. Comparison of Observed Number of Shots Inside Zones Bounded by Circles of Radii $r_1$ and $r_2$ in., with Number Expected from Bivariate Distribution with Radial Standard Deviation $\sigma_r$ , at four Ranges, R, in yd.	
Test 2 (Ei and Es)	103
Test 2 (Mi and Ms)	104
A8. Probabilities for Experts Firing Individually, of Obtaining Exactly 1, 2, 3, 4, and 5 hits on Type E Silhouette with Five-Shot Pattern Salvo for Indicated Target Ranges	105
A9. Probabilities for Marksmen Firing Individually, of Obtaining Exactly 1, 2, 3, 4, and 5 Hits on Type E Silhouette with Five-Shot Pattern Salvo for Indicated Target Ranges	105

Unclassified

Unclassified

### TARGET RANGE DIAGRAM

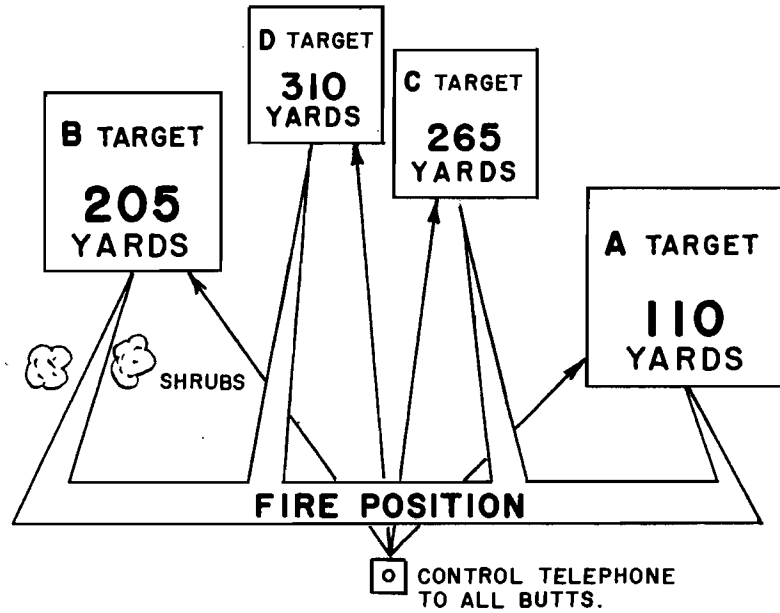

### BUTT WITH TARGET AND SCREEN

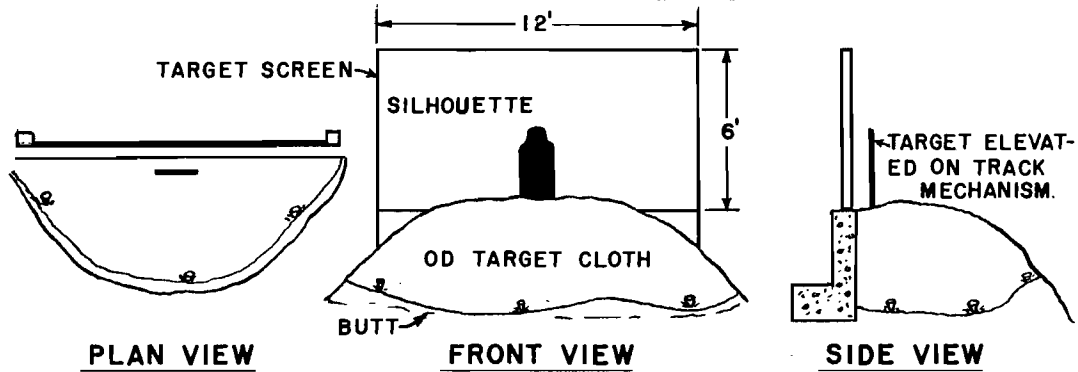

The range area can be described as a common-looking open-field area with gentle undulations in the ground and with heavy grass, shrubs, and the like covering the surface area as one would see in relatively open country in many parts of the world.

Unclassified

~~SECURITY SECRET INFORMATION~~ #18494

Unclassified

## SUMMARY

Results of expert riflemen and marksmen firing at man-size targets at different ranges were analyzed to determine aiming errors as function of range. The aiming errors in mils were found to be independent of range. Results of the analysis were used to compute the probability of hitting targets smaller than the man-size target and, therefore, more realistically representative of the average area presented by men in combat. Results of the analysis were also used to predict the probabilities of hitting targets with a hypothetical weapon firing a five-shot pattern and a four-shot pattern salvo. The probability of obtaining at least one hit from a single-salvo firing was found to be decidedly greater than the probability of hitting with a single-shot weapon. Probabilities of obtaining multiple hits with the salvo-weapon were also computed. Finally, the effect of weapon dispersion on the probability of hitting was determined. These computations show that eliminating the weapon-ammunition dispersion would not materially improve the rifleman's hit probability.

## INTRODUCTION

In the BALANCE study of the Army weapons system, examination of the basic hand arm of the infantry, the rifle, indicated a need to study the effectiveness of aimed rifle fire on man-size targets at ranges of combat interest. Heretofore, marksmanship has been measured by scoring hits on target only, and sufficient evidence could not be obtained on the nature of the dispersion (magnitude of errors) of all rounds fired.

To provide basic parameters for the whole rifle study, a field test was conducted at Fort Belvoir, Va., where expert riflemen and marksmen were used in a series of experiments designed to provide data from which meaningful conclusions could be drawn. Two grades of riflemen (expert and marksman) were used so that by Army standards the upper and lower limits of marksmanship could be studied. By having the men fire on man-silhouette targets (type E) at battle ranges of 100-300 yd on a transition type range, an element of combat realism was provided. In order to record and measure the dispersion of rounds, target screens 6 ft high and 12 ft wide were mounted behind the silhouette target at each range. The Appendix Frontispiece shows the design of the range used and the manner in which targets were located.

ORO-T-160

Unclassified

49

~~SECURITY SECRET INFORMATION~~



~~SECRET~~  
UNCLASSIFIED #18495

Dimensions of the screens and test procedures were products of preliminary trials designed to determine the methodology and physical requirements necessary to study the man-rifle complex on the desired basis. The target butts were draped with OD target cloth so that rounds below the target and screen could be taken into account by the perforations made in the cloth. The target cloth also was useful in camouflaging the mounds of earth at each target location.

In the test plan, psychological factors which might have arisen in group firing were eliminated by arranging groups of experts and marksmen with equal representation on the fire line. Also, to remove any learning effects in the experiment, the order of fire on targets was arranged in a manner to follow a latin square type of plan. This plan allowed each man to complete his firing serial on four ranges by ending the serial on the target with which he had begun, making a total of five target shoots on four ranges. Learning was not found to be a significant variable, and is not included in the analysis.

Test personnel were selected according to marksmanship scores from 13 training companies in the Engineer Replacement Training Center, Fort Belvoir, Va. Sixteen riflemen (eight experts and eight marksmen) were used on each of the two tests which were conducted on different days. Since different men were used in each test, a total of 32 men were employed in the whole experiment. The following outline shows the variety of conditions studied and the plan of tests. The shots on target and screen were color-coded in each experiment to make identification possible. All firing was done from the prone position using M-1 rifles and battle sights.

## ANALYSIS

### Objective

The objective of the analysis was to determine accuracy of aimed rifle fire, and its dependence on target range, for marksmen and experts firing the M-1 rifle under the conditions previously described. The accuracy thus obtained was required as a basis for predicting with reasonable reliability, the results which might be obtained with a hypothetical weapon of comparable accuracy which could fire several bullets in a pre-determined pattern.

### Data from Tests

The locations of bullet holes, derived from the tests are

UNCLASSIFIED

**PLAN OF RIFLE MARKSMANSHIP TESTS**  
 Fort Belvoir, Va., 27 Oct and 10 Nov 1951

Plan of Tests 1 and 2

Purpose	Subject	Order of Fire	Conditions
To evaluate individual marksmanship	E	A-B-C-D-A	Targets (silhouettes) exposed for 3 sec every 3 sec. For each exposure, each man fired one round; 8 rounds fired per man per target. Firing done in 4-man serials.
	M	C-D-A-B-C	
	E	B-A-D-C-B	
	M	D-C-B-A-D	
	E	A-D-C-B-A	Conditions repeated.
	M	B-C-D-A-B	
	E	D-A-B-C-D	
	M	C-B-A-D-C	
	E	A-B-C-D-A	Conditions repeated.
	M	C-D-A-B-C	
	E	B-A-D-C-B	
	M	D-C-B-A-D	
	E	A-D-C-B-A	Conditions repeated.
	M	B-C-D-A-B	
	E	D-A-B-C-D	
	M	C-B-A-D-C	
To evaluate group marksmanship	8 experts	B-A-D-C-B	Target exposed for 3 sec every 3 sec. Group fired simultaneously at each range, single round firing for each exposure, 4 rounds per target per man.
	8 marksmen	B-A-D-C-B	Same conditions as for experts.

Test No. 3

To study effects of rapid fire when order of target appearance is unknown	4 marksmen	C-A-C-C-A-A-C-A	Targets exposed for only 1 sec, alternate snap shooting at two target ranges, schedule of exposure shown was unknown to the men. Experiment was done for group or simultaneous firing and for individual firing.
	4 experts	C-A-C-C-A-A-C-A	Same as above conditions.

KEY

E = Expert	B = Tgt at 205 yd
M = Marksman	C = Tgt at 265 yd
A = Tgt at 110 yd	D = Tgt at 310 yd

~~SECRET~~  
#18497  
Unclassified

shown in Figs. A1 to A32, on which are also indicated the number of shots which were fired and the number of these which hit the screen. In most of the tests, some of the rounds did not hit the screen. Most, if not all, of these were observed to have hit the ground in front of the screen. While the percentage of shots hitting the target, as tabulated in the last column of Table A1 is, of course, a function of accuracy, it does not provide complete information on the nature of the dispersion of the shot-pattern.

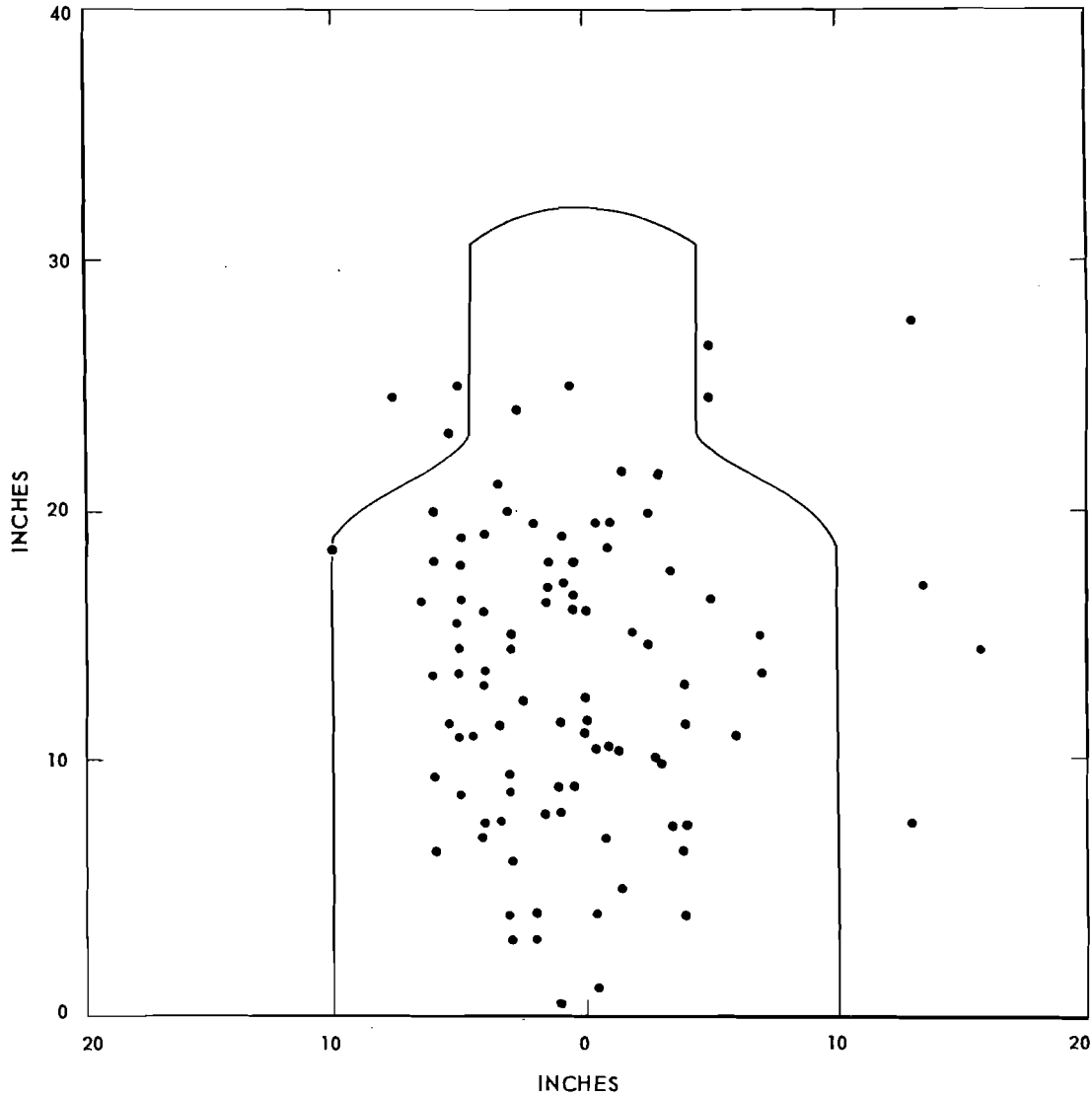

Fig. A1—110 yard range (Test No. 1), expert riflemen firing individually, 96 rounds fired (8 each by 12 men), 96 rounds on target cloth, 88 rounds on target

Unclassified

ORO-T-160

UNCLASSIFIED

~~SECRET~~ INFORMATION

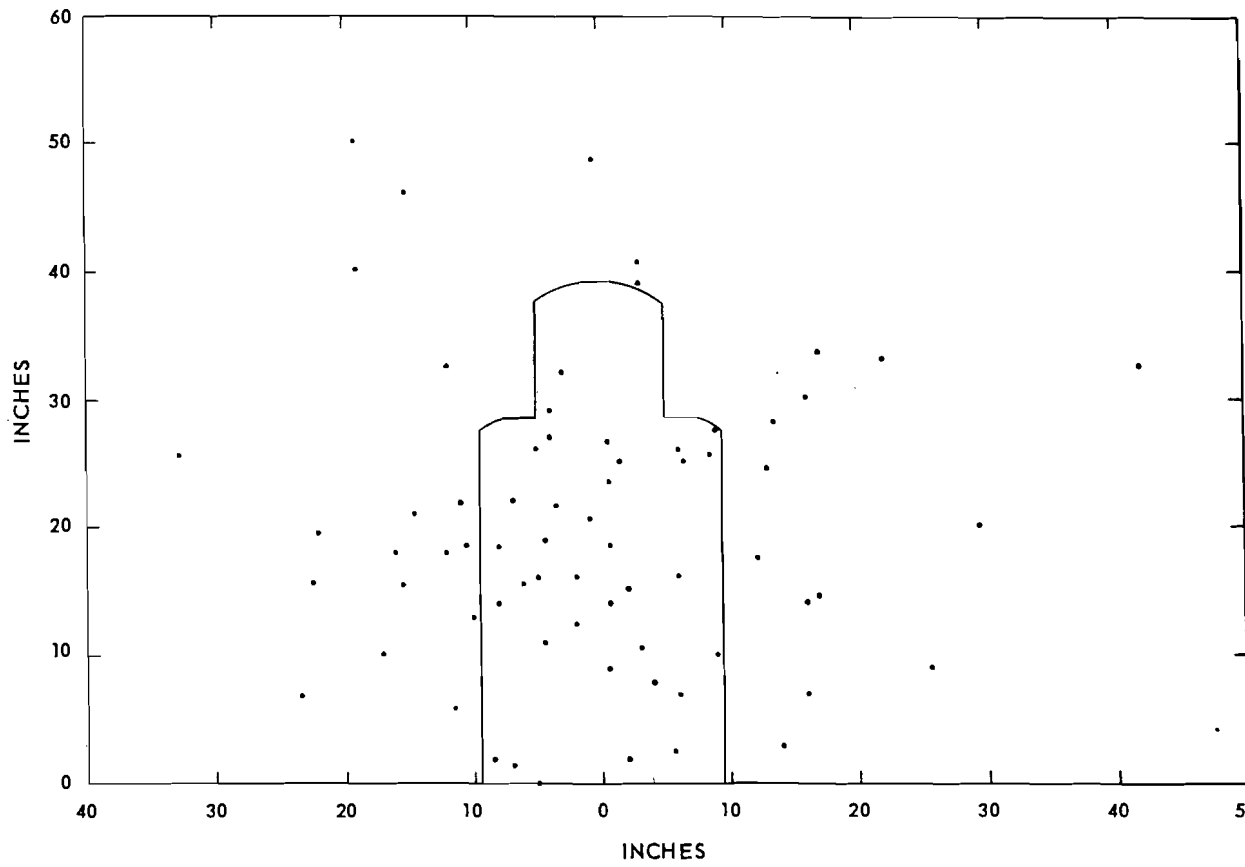

Fig. A2—205 yd range (Test No. 1), expert riflemen firing individually, 80 rounds fired (8 each by 10 men), 69 rounds on target cloth, 36 rounds on target

Unclassified

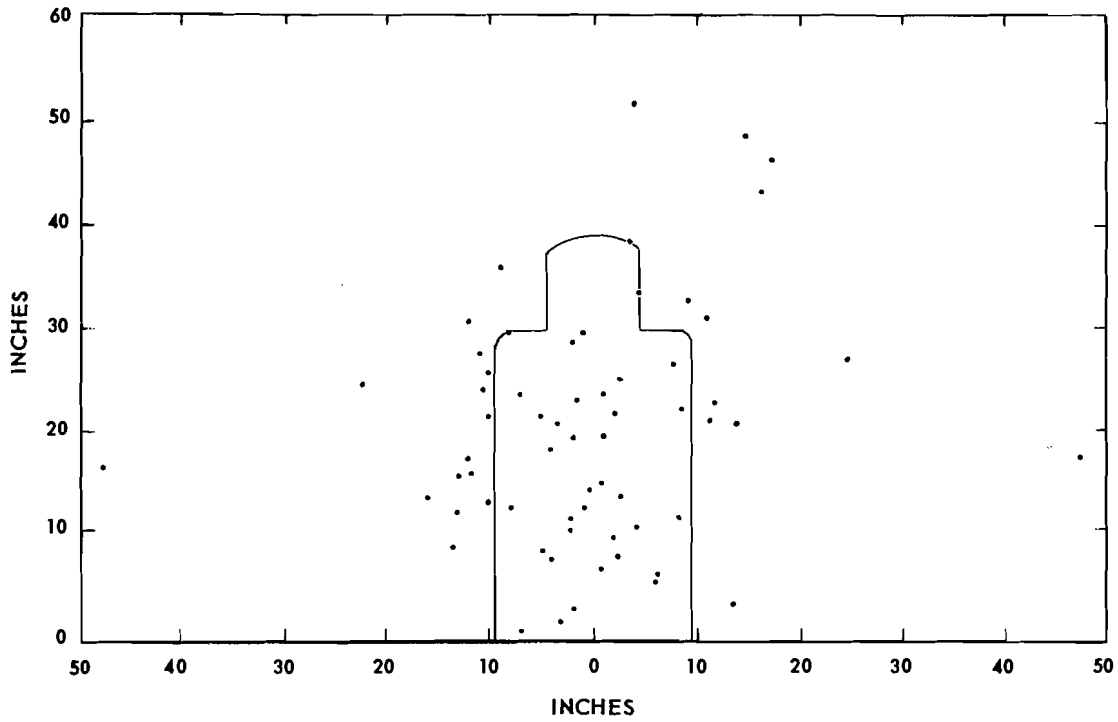

Fig. A3—265 yard range (Test No. 1), expert riflemen firing individually, 72 rounds fired (8 each by 9 men), 62 rounds on target cloth, 34 rounds on target

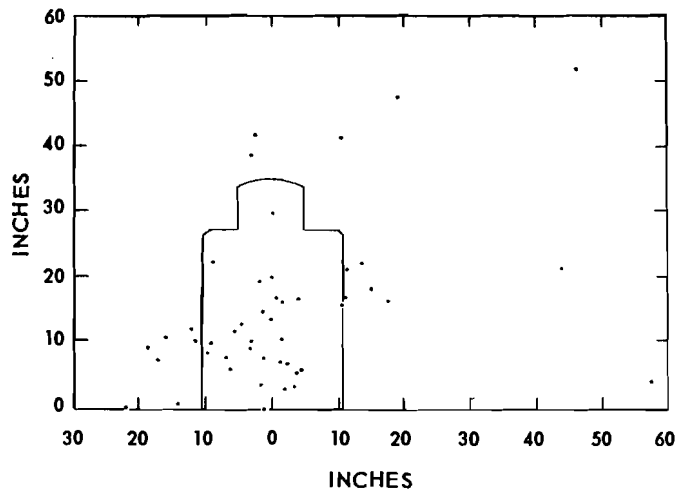

Fig. A4—310 yard range (Test No. 1), expert riflemen firing individually, 72 rounds fired (8 each by 9 men), 47 rounds on target cloth, 28 rounds on target

Unclassified

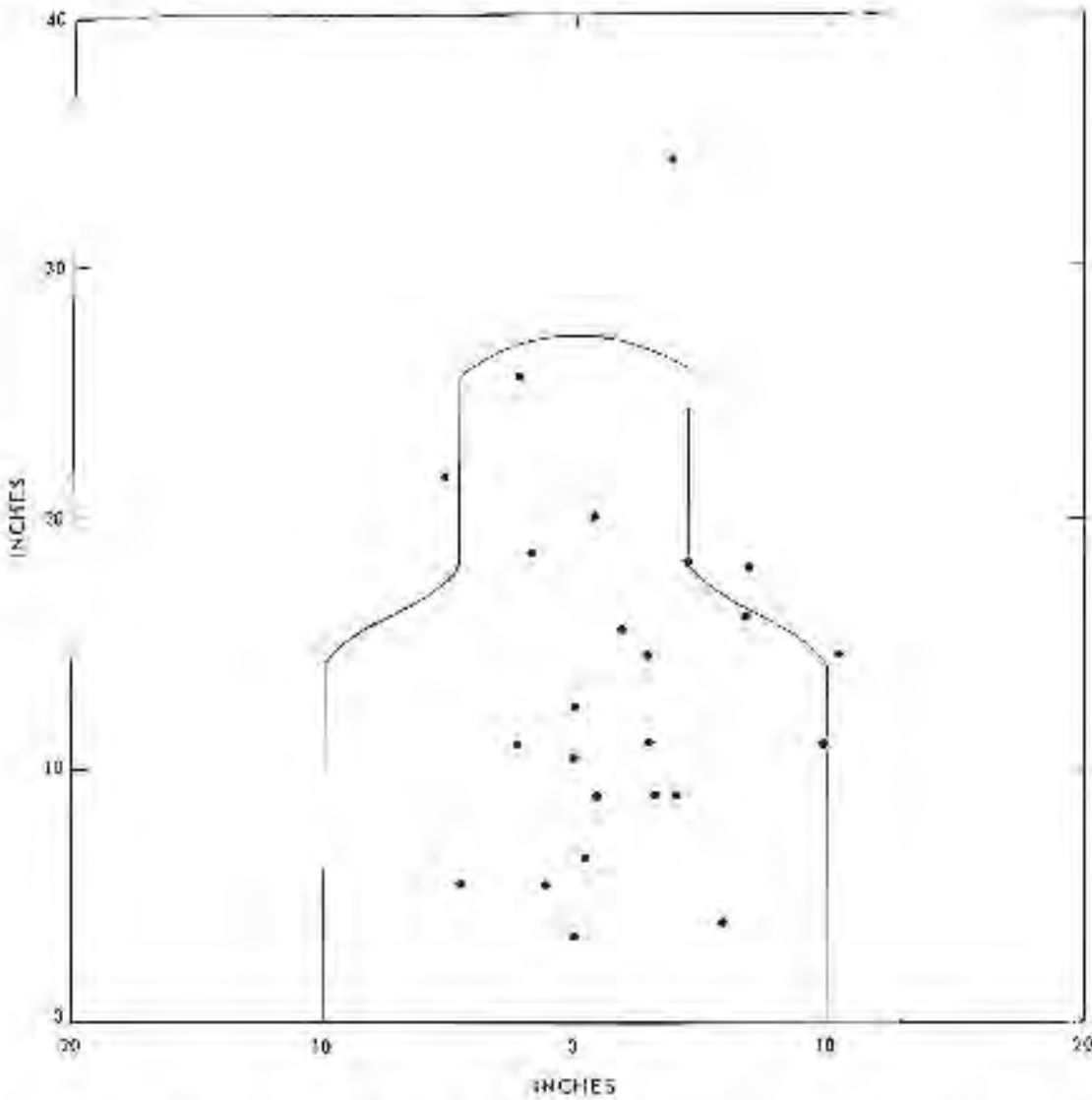

Fig. A5—110 yard range (Test No. 1), expert riflemen firing simultaneously, 32 rounds fired (4 each by 8 men), 24 rounds on target cloth, 20 rounds on target

~~SECRET~~  
UNCLASSIFIED

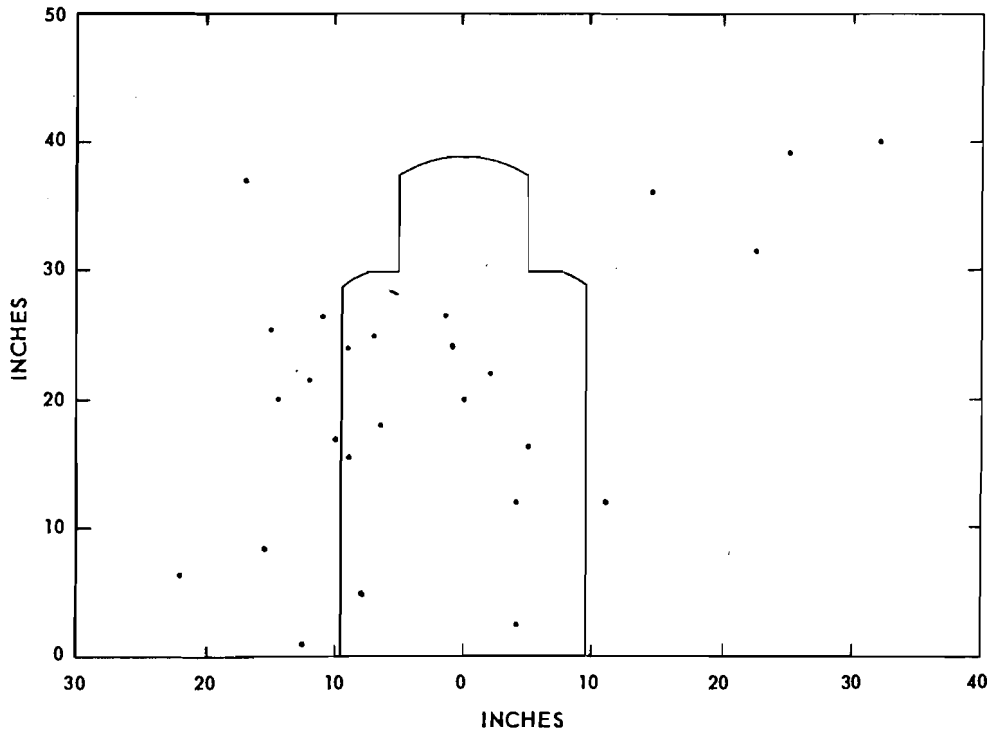

Fig. A6—205 yard range (Test No. 1), expert riflemen firing simultaneously, 32 rounds fired (4 each by 8 men), 26 rounds on target cloth, 12 rounds on target

~~SECRET~~  
UNCLASSIFIED

~~SECRET~~ #18502

Unclassified

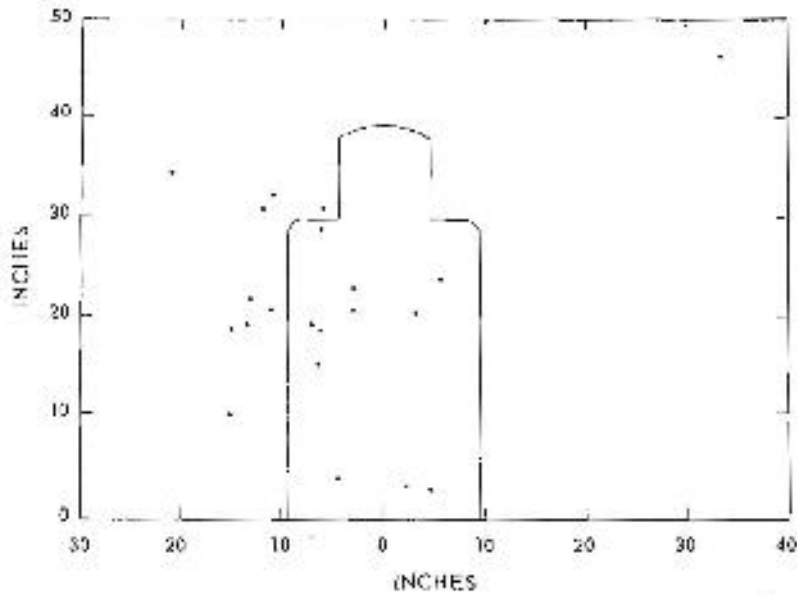

Fig. A7—265 yard range (Test No. 1), expert riflemen firing simultaneously, 32 rounds fired (4 each by 8 men), 21 rounds on target cloth, 11 rounds on target

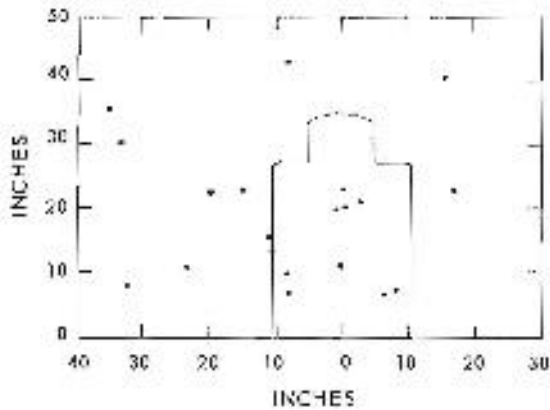

Fig. A8—310 yard range (Test No. 1), expert riflemen firing simultaneously, 32 rounds fired (4 each by 8 men), 19 rounds on target cloth, 9 rounds on target

Unclassified

~~SECRET~~



58

Unclassified

~~SECRET~~ INFORMATION

ORO-T-160

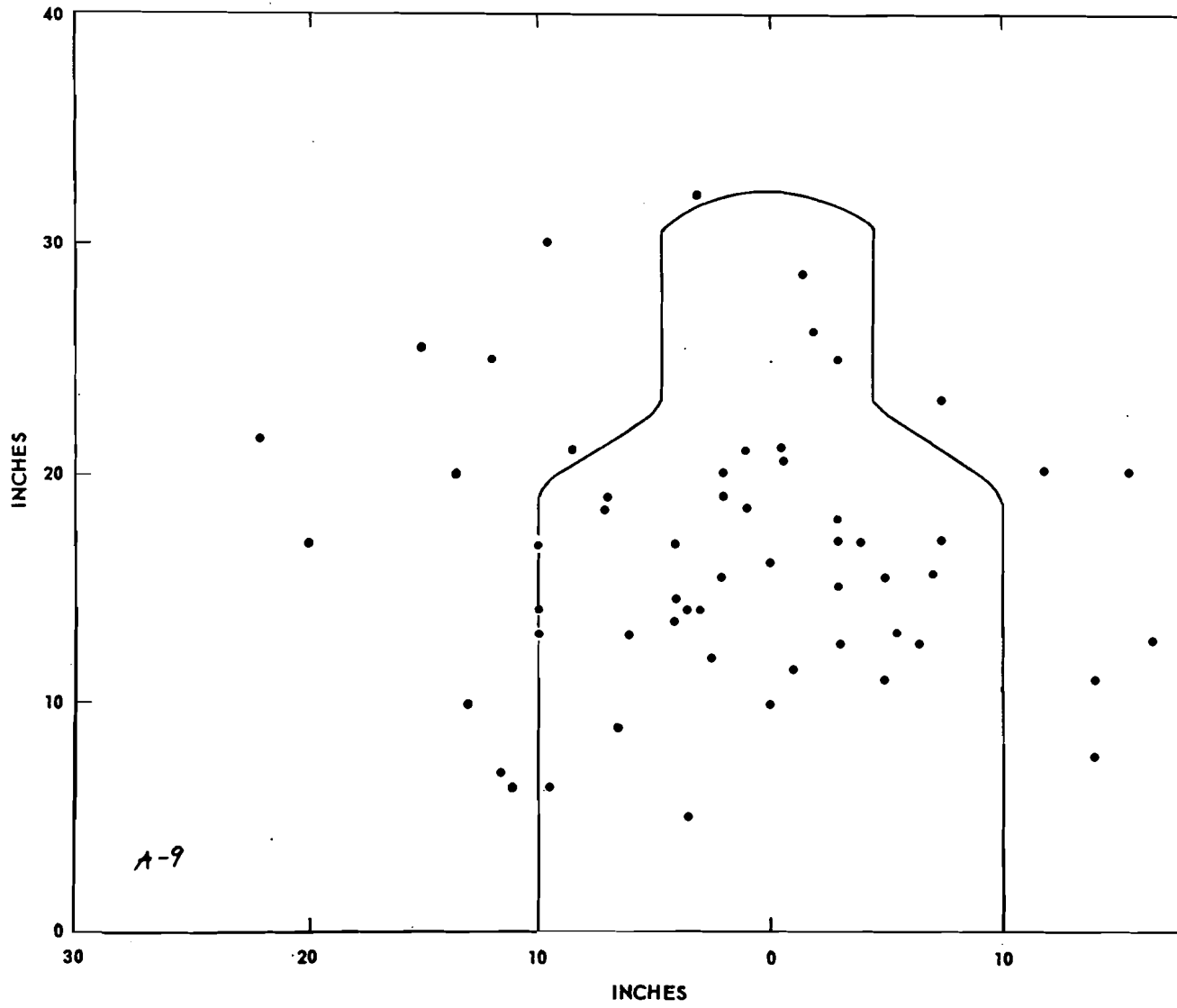

Fig. A9—110 yard range (Test No. 1), marksmen firing individually, 56 rounds fired (8 each by 7 men) – 8 rounds fired by Bates not included—56 rounds on target cloth, 39 rounds on target

ORO-T-160

~~SECRET~~

CONFIDENTIAL

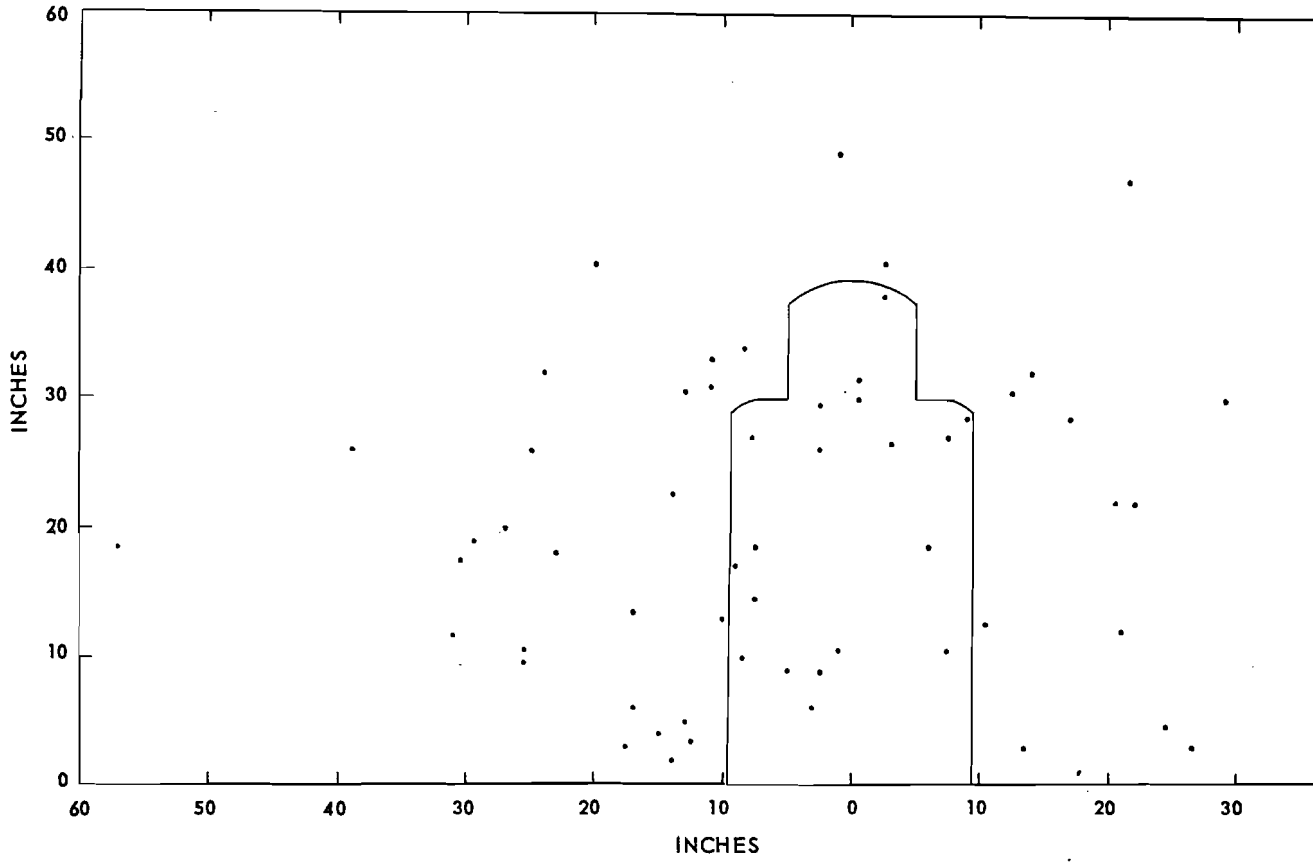

Fig. A10—205 yard range (Test No. 1), marksmen firing individually, 72 rounds fired (8 each by 9 men), 58 rounds on target cloth, 19 rounds on target

~~SECRET~~  
Unclassified

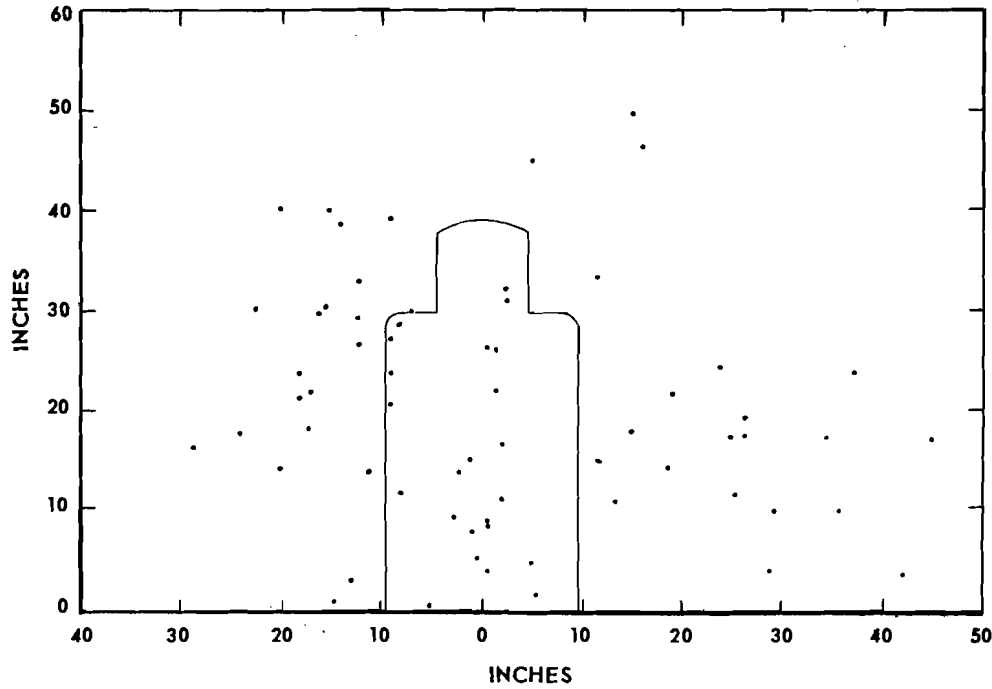

Fig. A11—265 yard range (Test No. 1), marksmen firing individually, 72 rounds fired (8 each by 9 men), 65 rounds hit target cloth, 25 rounds hit target

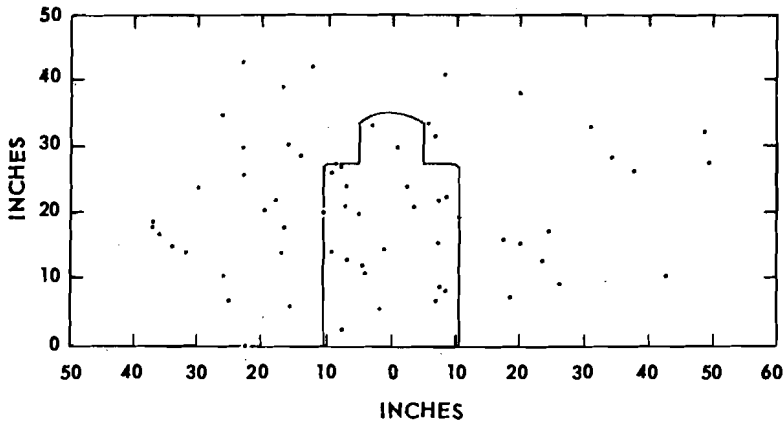

Fig. A12—310 yard range (Test No. 1), marksmen firing individually, 80 rounds fired (8 each by 10 men) - Bates excluded, 61 rounds on target cloth, 24 rounds on target

~~SECRET~~  
Unclassified

ORO-T-160

UNCLASSIFIED

SECRET INFORMATION

61

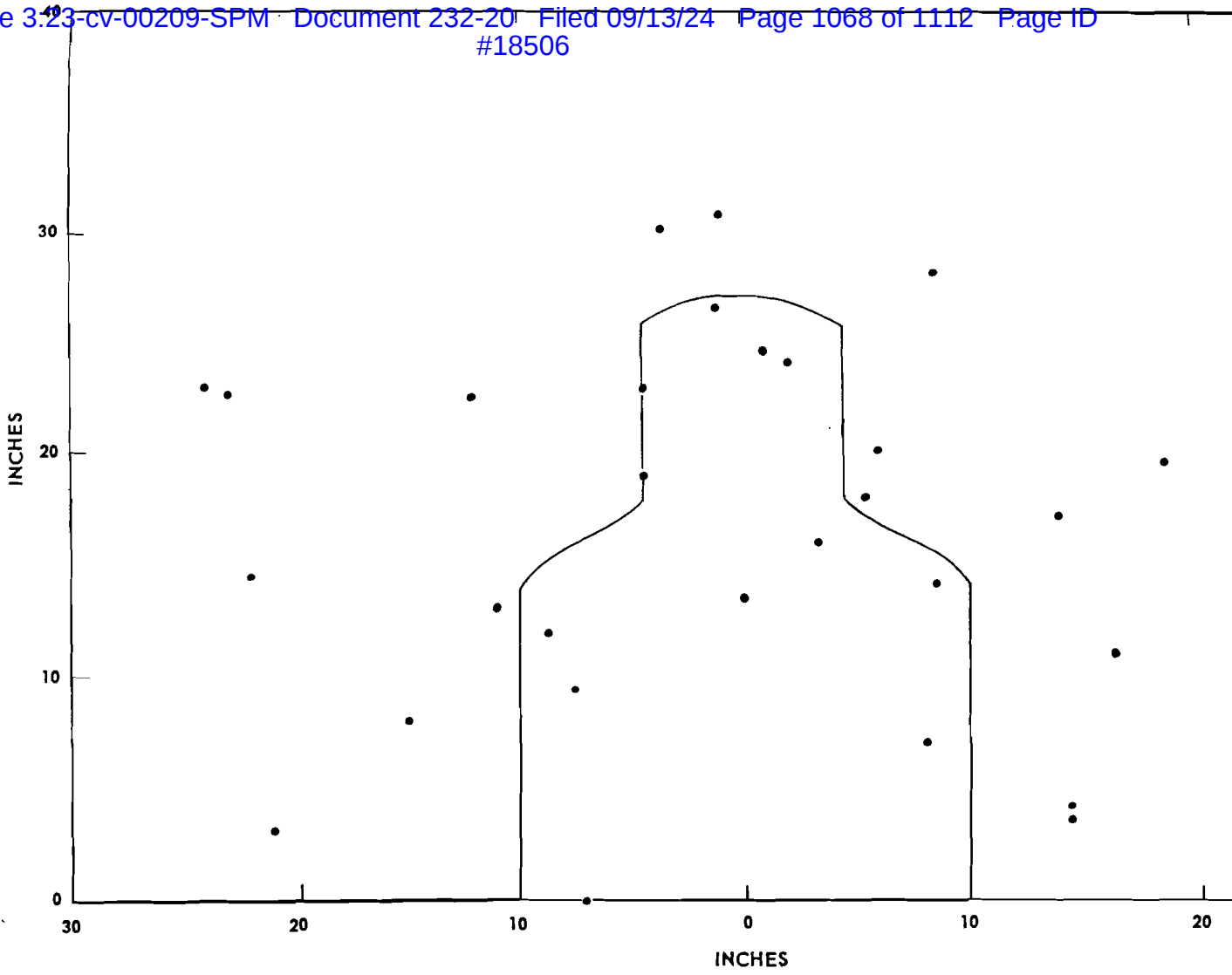

Fig. A13—110 yard range (Test No. 1), marksmen firing simultaneously, 32 rounds fired (4 each by 8 men), 30 rounds hit target

62

Unclassified

~~SECRET~~

ORO-T-160

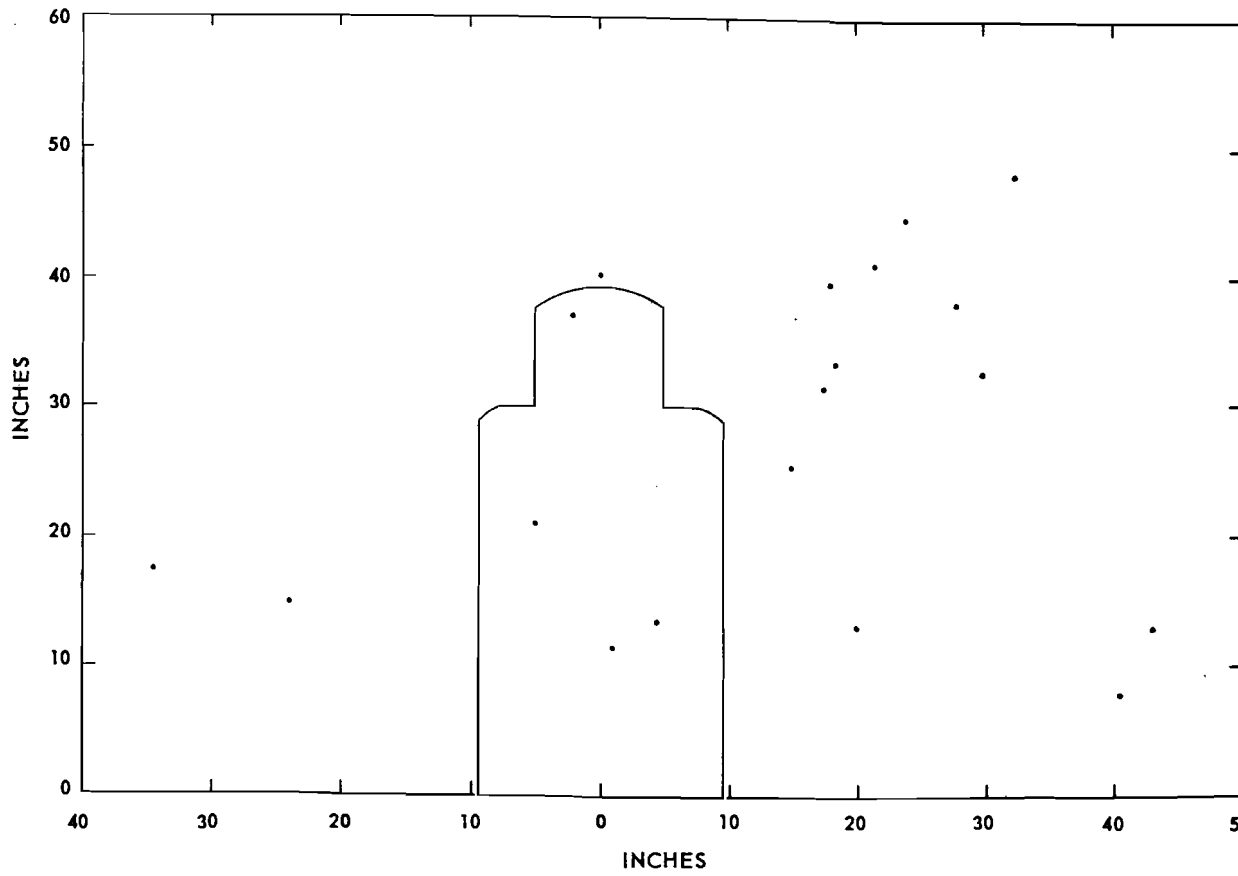

Fig. A14—205 yard range (Test No. 1), marksmen firing simultaneously, 32 rounds fired (4 each by 8 men)  
19 rounds on target cloth, 4 rounds on target

SECURITY ~~SECRET~~ INFORMATION #18508

Unclassified

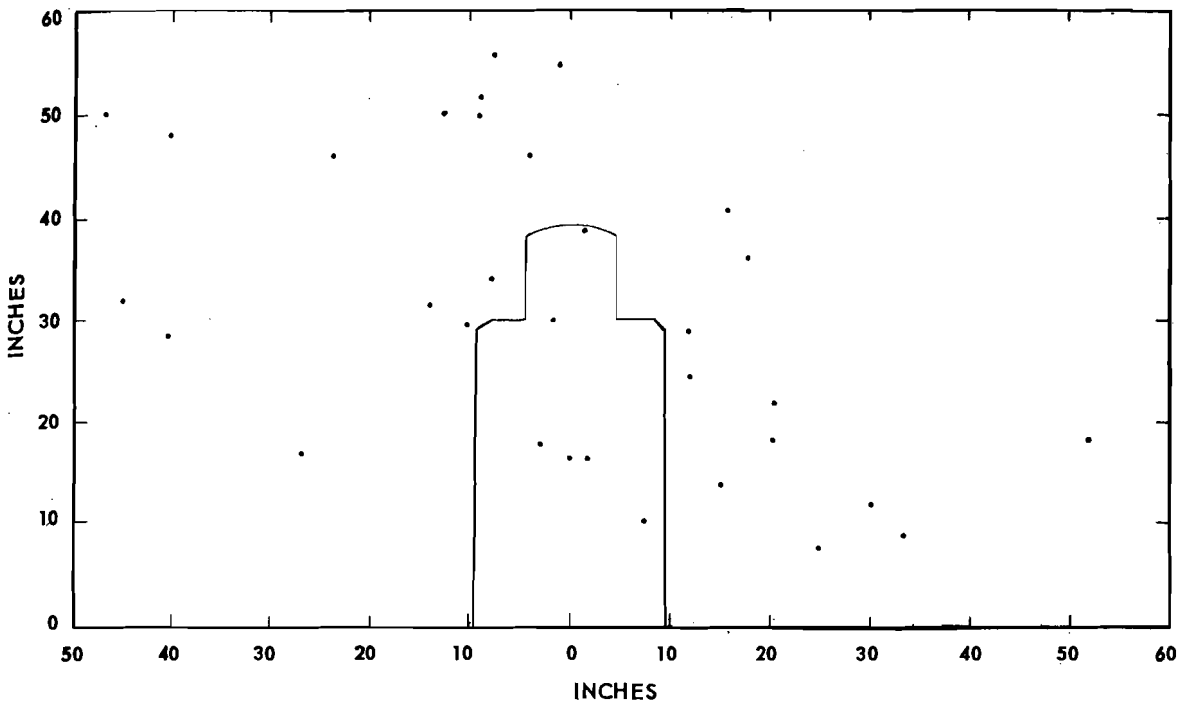

Fig. A15—265 yard range (Test No. 1), marksmen firing simultaneously, 32 rounds fired (4 each by 8 men), 32 rounds hit target cloth, 6 rounds hit target

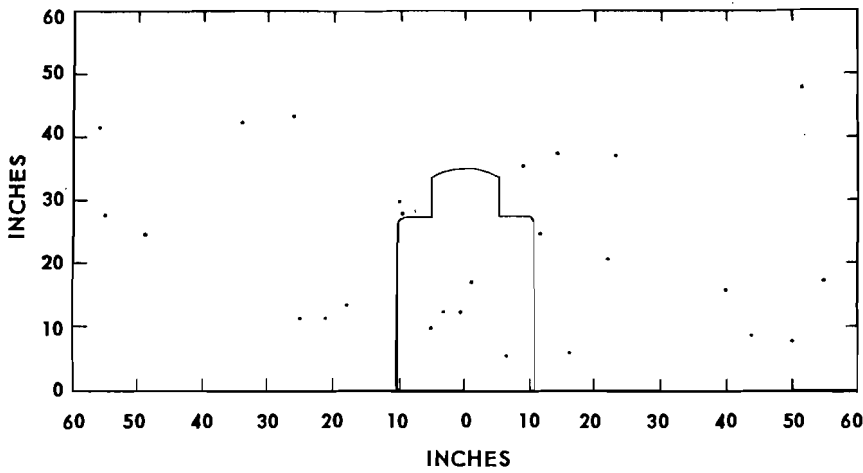

Fig. A16—310 yard range (Test No. 1), marksmen firing simultaneously, 32 rounds fired (4 each by 8 men), 25 rounds hit target cloth, 4 rounds hit target

Unclassified

SECURITY ~~SECRET~~ INFORMATION

Unclassified

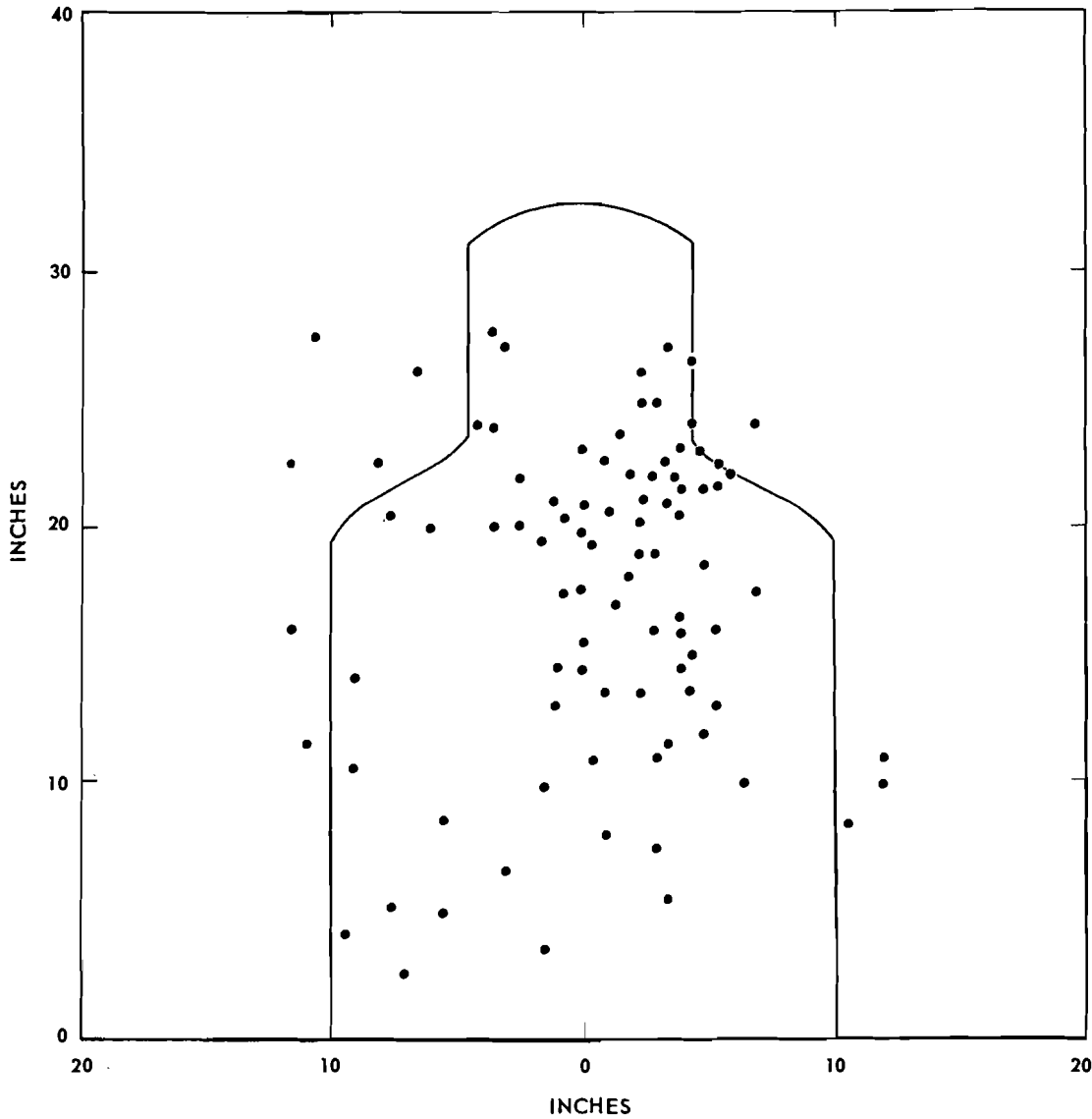

Fig. A17—110 yard range (Test No. 2), expert riflemen firing individually, 96 shots fired (8 each by 12 men), 91 rounds hit target cloth, 81 rounds hit target

Unclassified

~~SECRET~~ INFORMATION

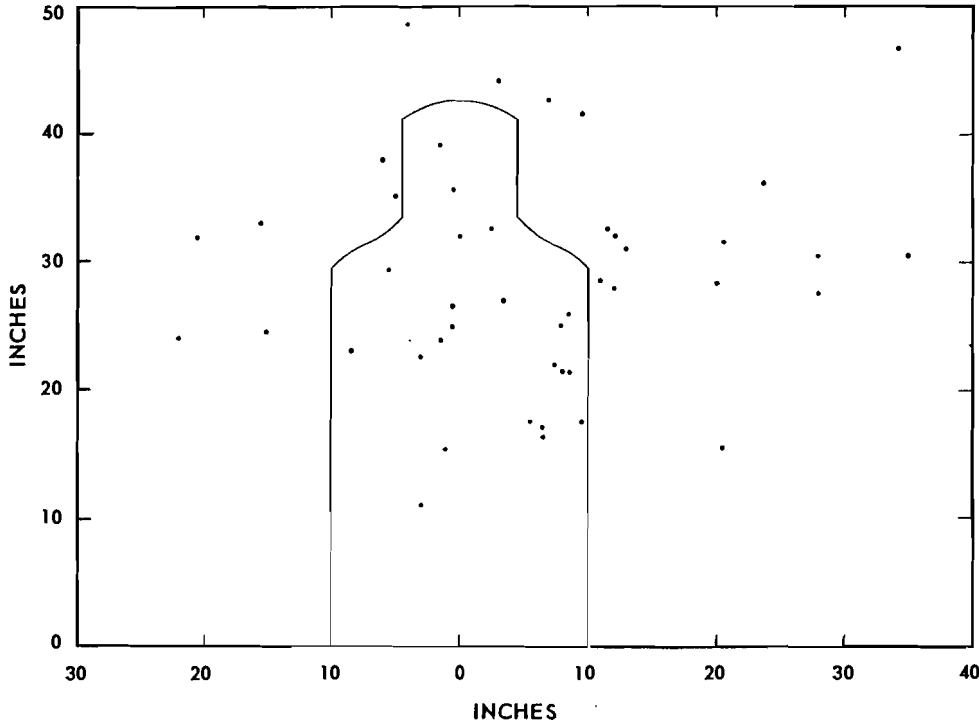

Fig. A18—205 yard range (Test No. 2), experts firing individually, 64 rounds fired (8 each by 8 men), 45 rounds hit target cloth, 22 rounds hit target



Unclassified

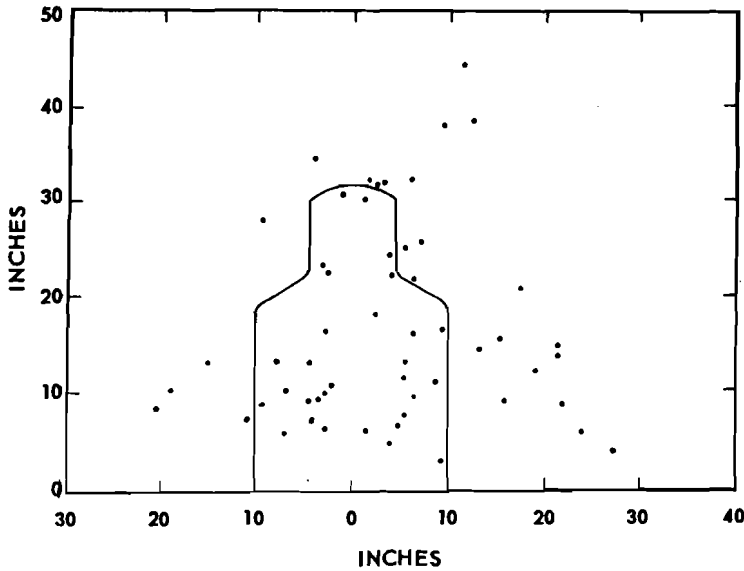

Fig. A19—265 yard range (Test No. 2), expert riflemen firing individually, 64 rounds fired (8 each by 8 men), 56 rounds on target cloth, 30 rounds on target

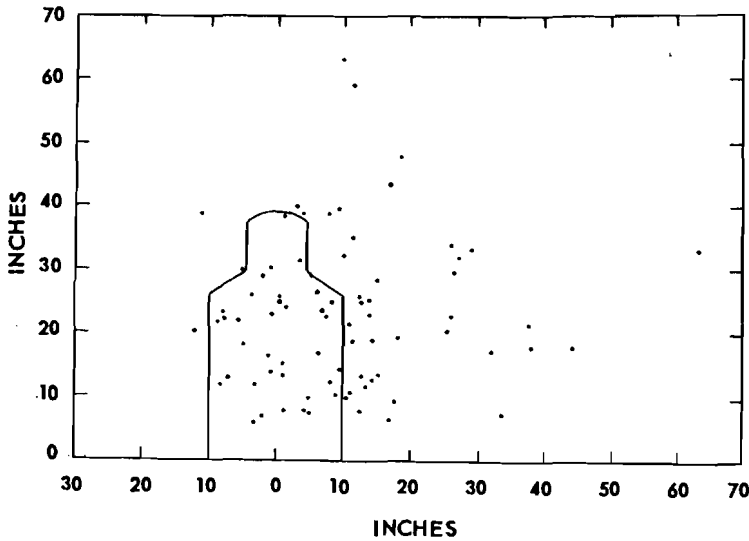

Fig. A20—310 yard range (Test No. 2), expert riflemen firing individually, 80 rounds fired (8 each by 10 men), 77 rounds hit target cloth, 35 rounds hit target

Unclassified

~~SECRET~~ INFORMATION  
Unclassified

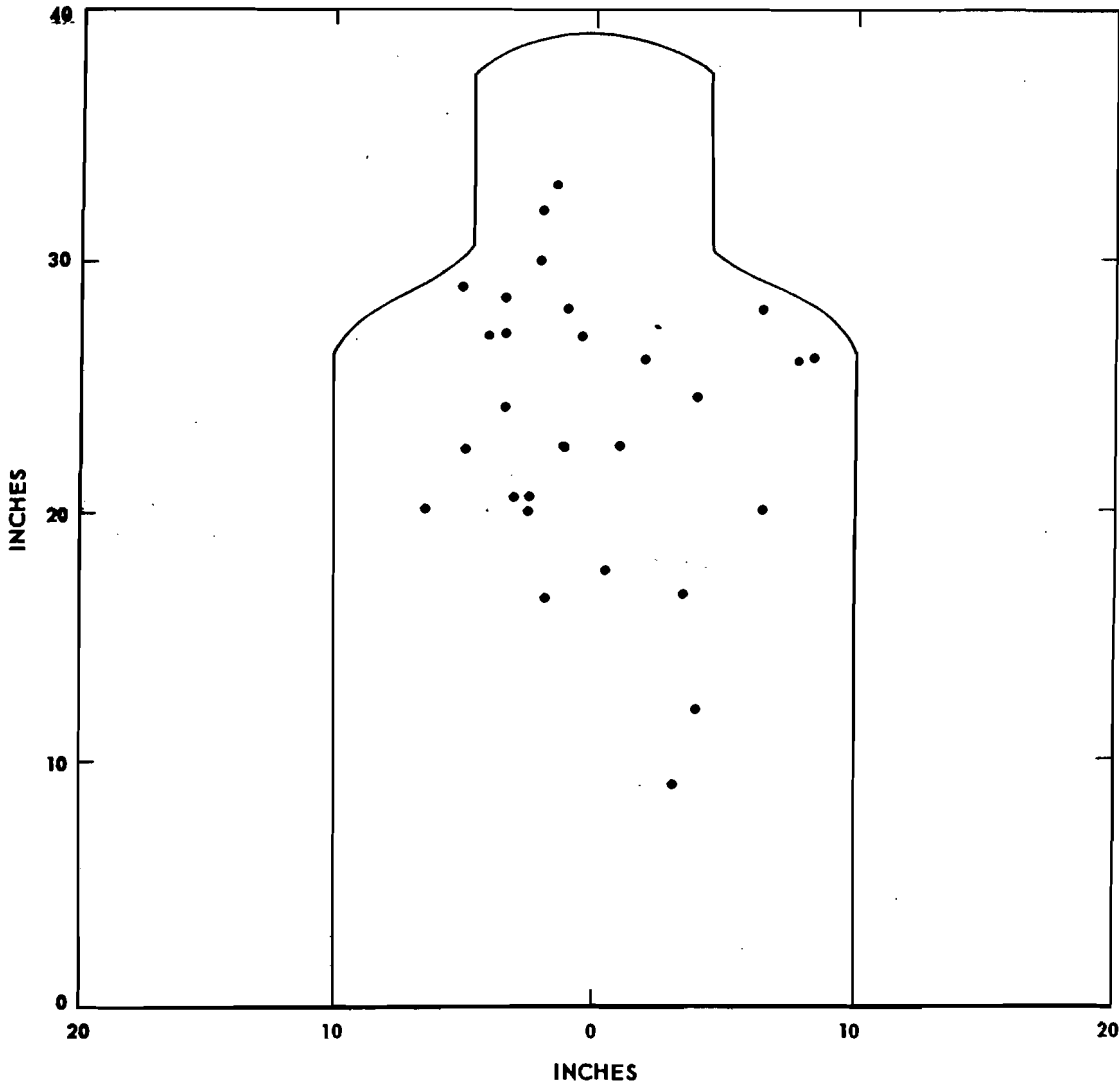

Fig. A21—110 yard range (Test No. 2), experts firing simultaneously, 32 rounds fired (4 each by 8 men), 28 rounds hit target cloth, 28 rounds hit target

Unclassified

89

SECRET

Unprocessed

ORO-T-160

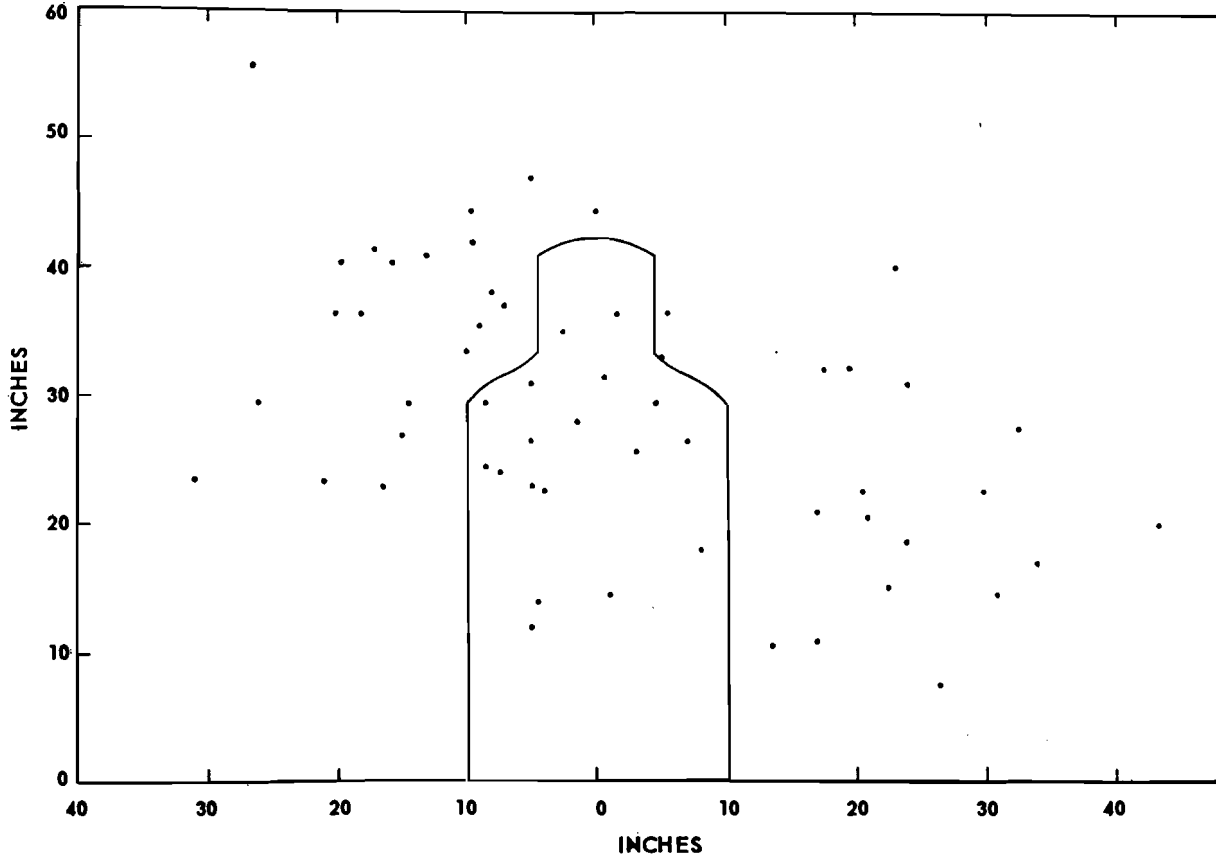

Fig. A22—205 yard range (Test No. 2), experts firing simultaneously, 64 rounds fired (4 each by 16 m  
58 rounds hit target cloth, 19 rounds hit target

Unclassified

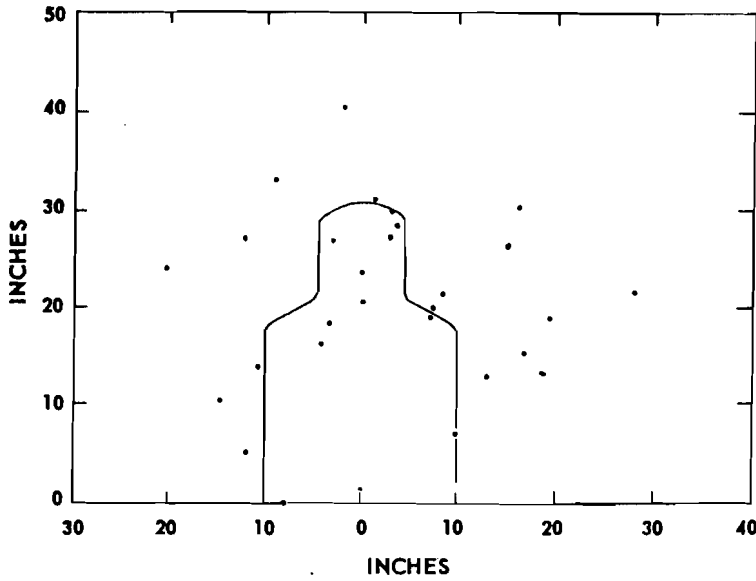

Fig. A23—265 yard range (Test No. 2), expert riflemen firing simultaneously, 32 rounds fired (4 each by 8 men), 28 rounds on target cloth, 13 rounds on target

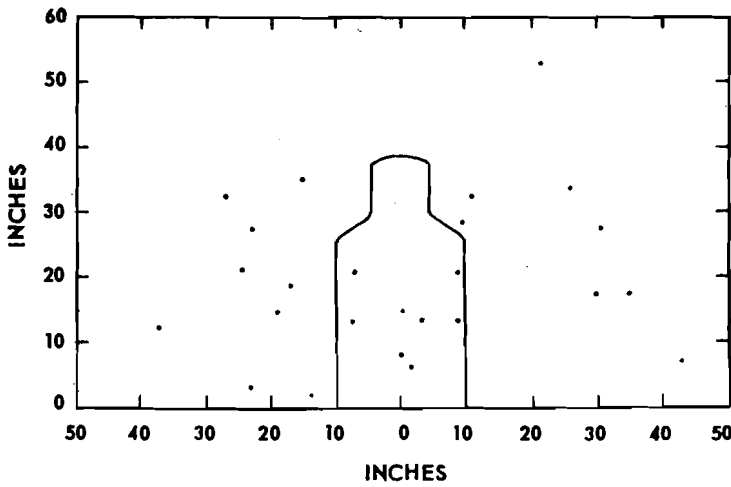

Fig. A24—310 yard range (Test No. 2), expert riflemen firing simultaneously, 32 rounds fired (4 each by 8 men), 25 rounds hit target cloth, 8 rounds hit target

Unclassified  
~~SECURITY SECRET INFORMATION~~

Unclassified

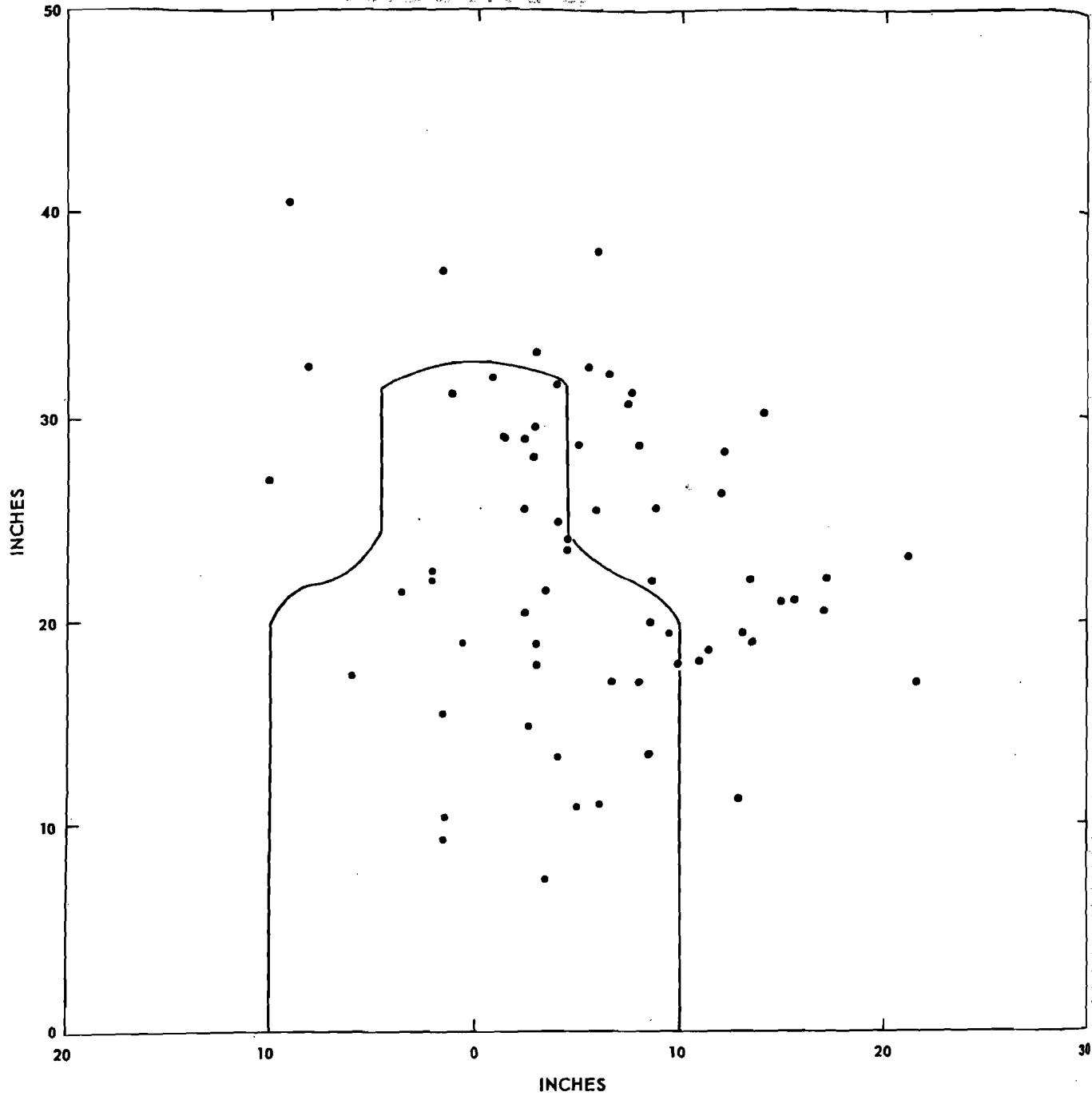

Fig. A25—110 yard range (Test No. 2), marksmen firing individually, 64 shots fired (8 each by 8 men), 64 rounds hit target cloth, 34 rounds hit target

Unclassified

#18516

ORO-T-160

INCHES

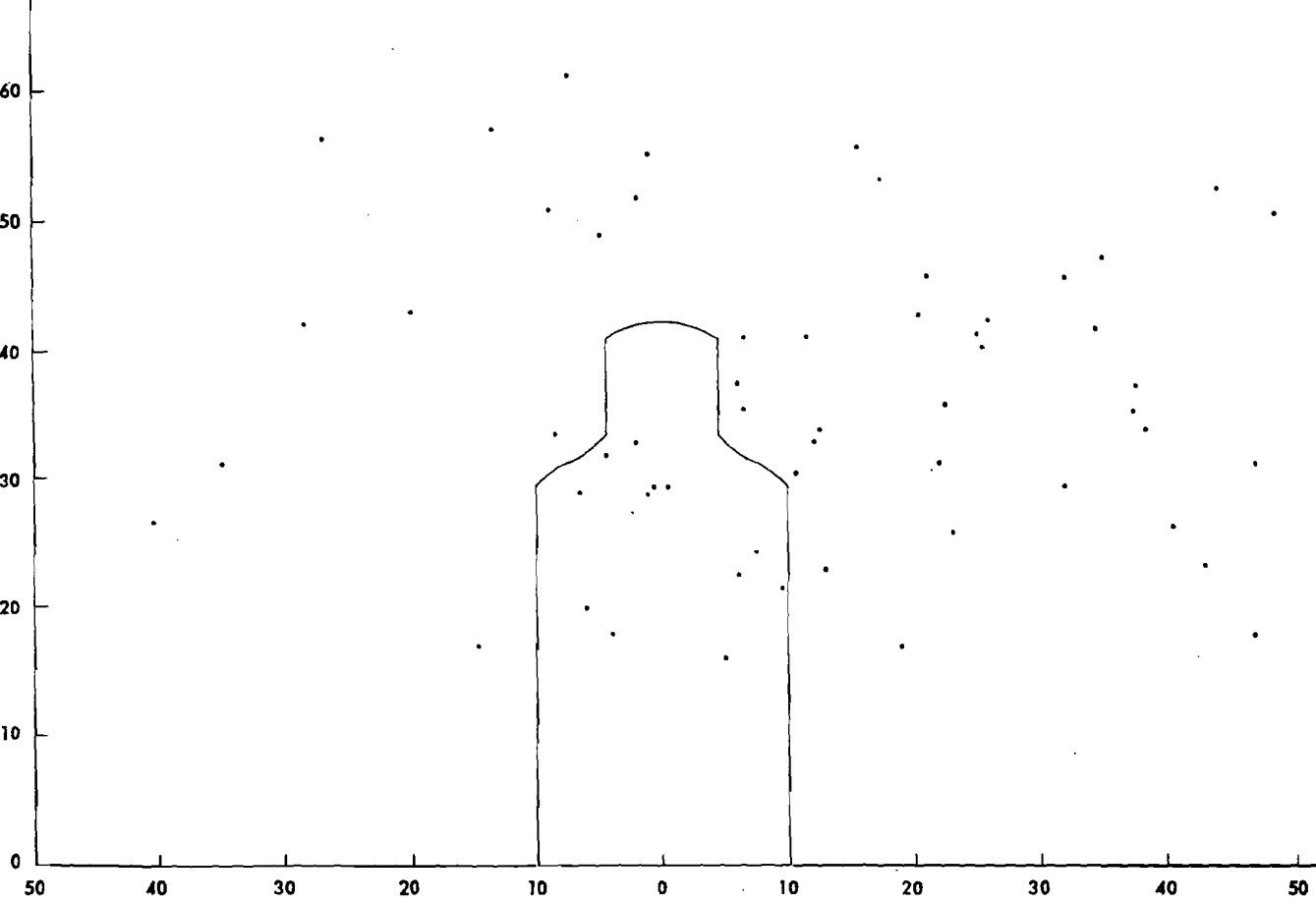

INCHES

Fig. A26—205 yard range (Test No. 2), marksmen firing at target individually, 72 rounds fired (8 each by 9men), 59 rounds hit target cloth, 12 rounds hit target

SECRET

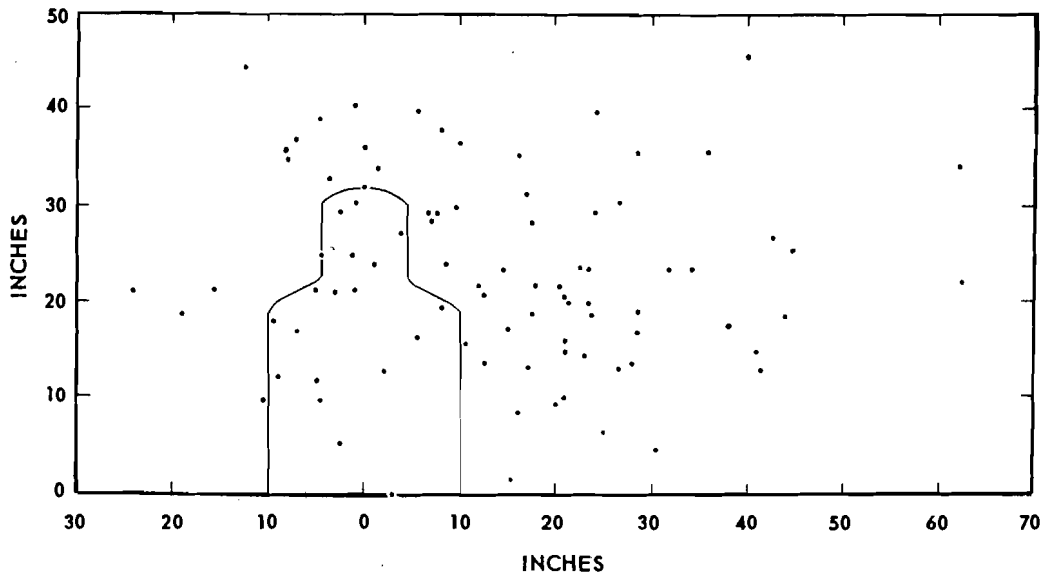

Fig. A27—265 yard range (Test No. 2), marksmen firing individually, 96 rounds fired (8 each by 12 men), 88 rounds on target cloth, 19 rounds on target

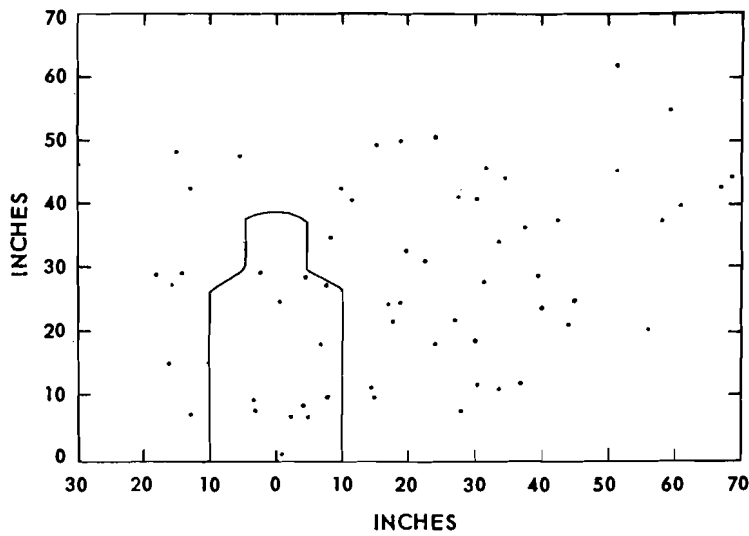

Fig. A28—310 yard range (Test No. 2), marksmen firing individually, 80 rounds fired (8 each by 10 men), 61 rounds hit target cloth, 12 rounds hit target

Unclassified

ORO-T-160

~~SECURITY~~ ~~SECRET~~ INFORMATION

Classification

73

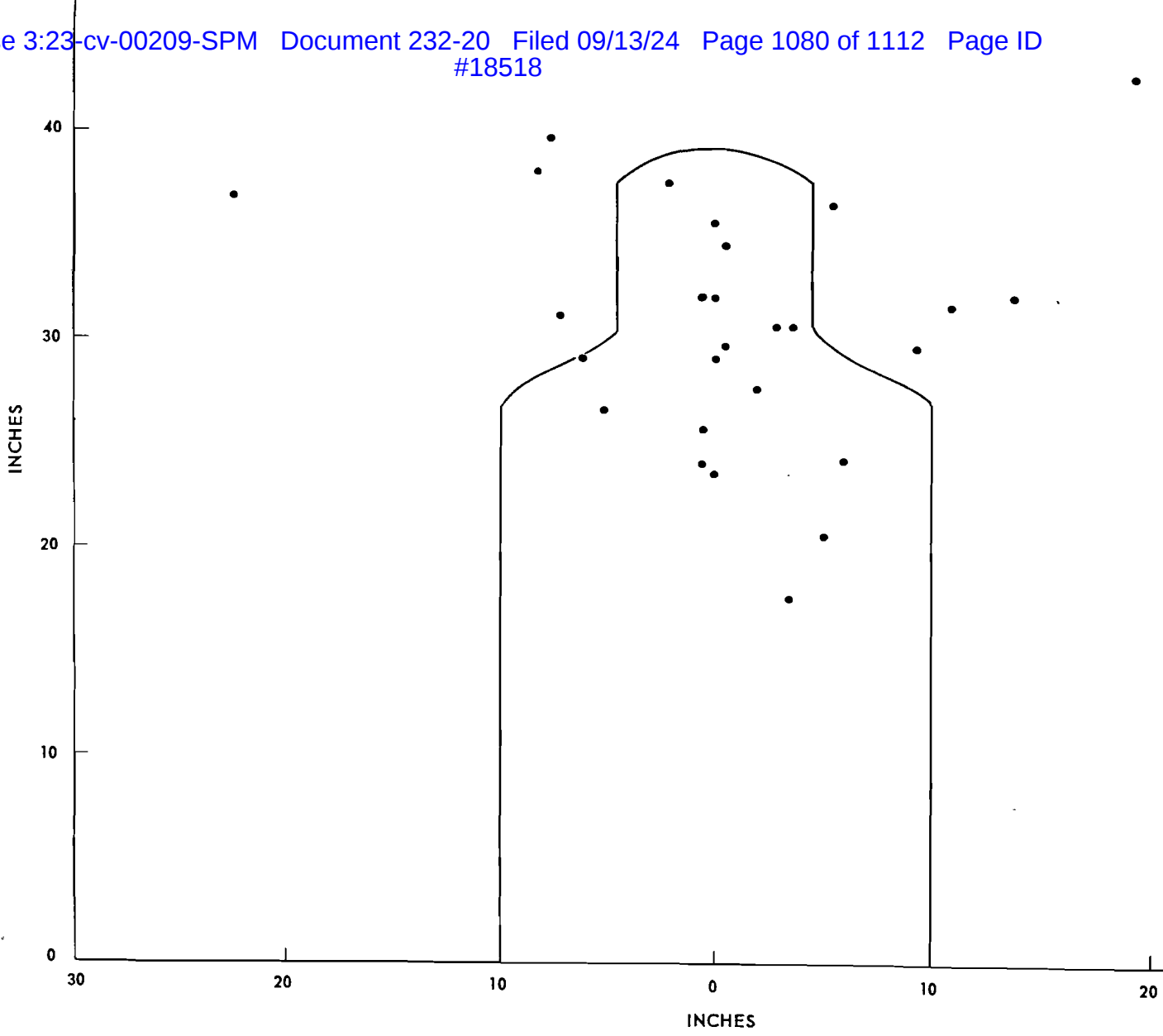
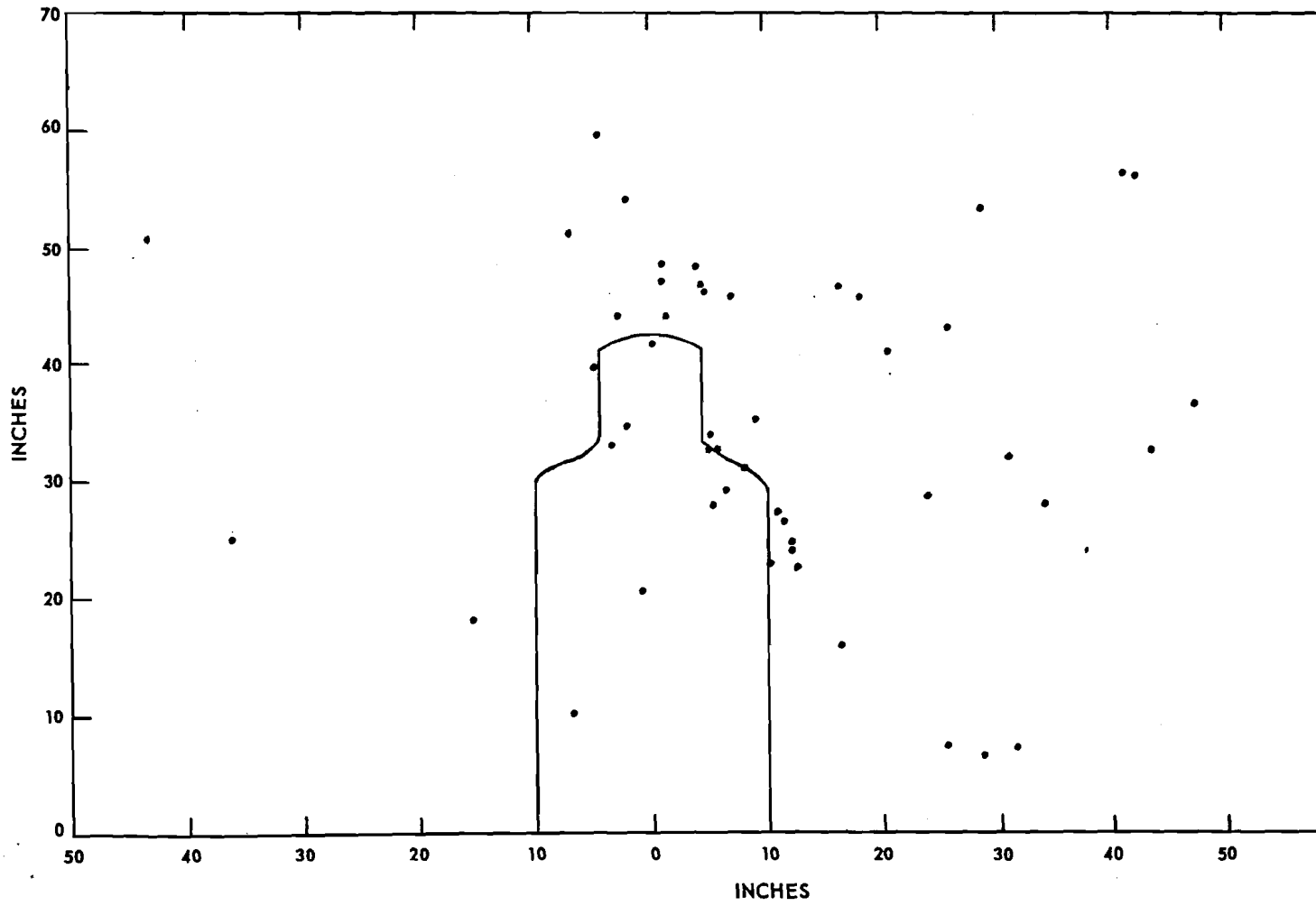

Fig. A29—110 yard range (Test No. 2), marksmen firing simultaneously, 32 rounds fired (4 each by 8 men), 29 rounds hit target cloth, 18 rounds hit target



Unclassified  
74  
SECRET  
SECURITY INFORMATION



ORO-T-160

Fig. A30—205 yard range (Test No. 2), marksmen firing simultaneously, 65 rounds fired (4 each by 16 men) - 1 man fired 5 rounds - 49 rounds hit target cloth, 10 rounds hit target

~~SECRET~~  
UNCLASSIFIED

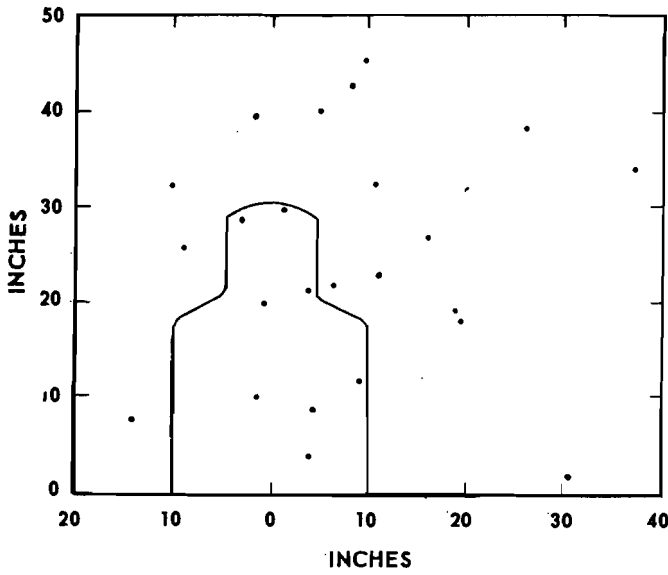

Fig. A31—265 yard range (Test No. 2), marksmen firing simultaneously, 32 rounds fired (4 each by 8 men), 24 rounds hit target cloth, 8 rounds hit target.

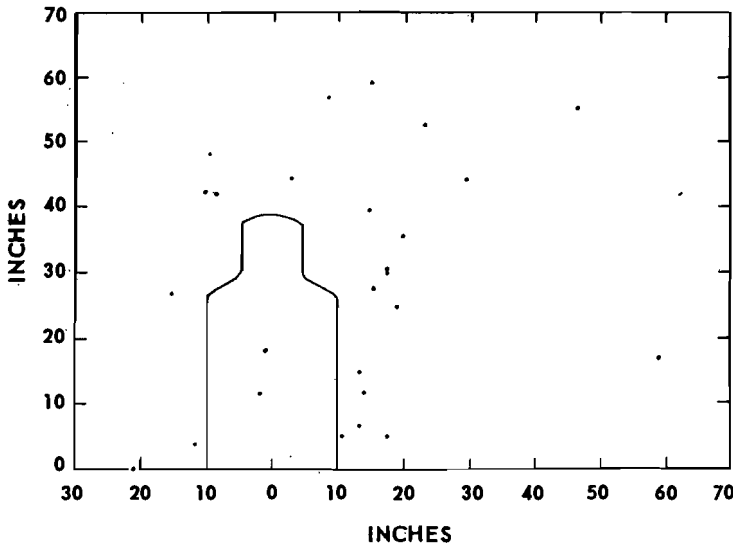

Fig. A32—310 yard range (Test No. 2), marksmen firing simultaneously, 32 rounds fired (4 each by 8 men), 26 rounds hit target cloth, 2 rounds hit target

~~SECRET~~  
UNCLASSIFIED

~~SECRET~~  
~~SECURITY INFORMATION~~  
 Unclassified

Determination of Means (mpi)  
and Dispersion (Standard Deviation)

As already indicated, the location of those rounds which did not hit the target or screen, is, of course, unknown. How then can the mean (mpi) and dispersion (standard deviation) be determined when these depend on the actual location of all shots? This problem is most conveniently solved by using probability paper as illustrated in Fig. A33.

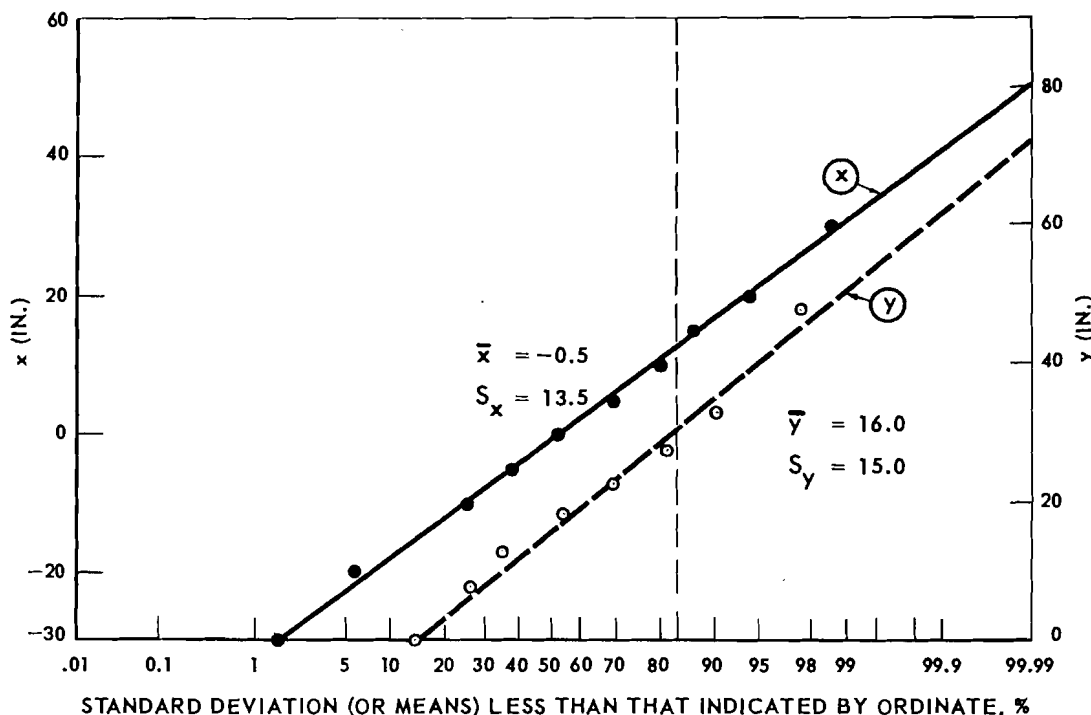

Fig. A33—Example illustrating use of probability paper to determine standard deviations and means, whether or not distribution is truncated. Data are from Test 1, experts firing individually at 205 yd.

Suppose  $x$  is a variable normally distributed about mean  $\bar{x}$ , and suppose from a sample of  $n$   $x$ 's  $F_1$  is determined, where  $F_1$  is the fraction of all the  $x$ 's in the sample which have values less than  $x_1$ , and  $F_2$  the fraction containing all values of  $x$  less than  $x_2$  ( $x_2 > x_1$ ) and so on to  $F_n$ . Then for a normal distribution of the  $x$ 's, the scale of  $F$  (abscissa scale of Fig. A33) is so designed that when values of  $F$  are plotted against the corresponding  $x$ , the points determine a straight line. The ordinate, on this line, corresponding to abscissa  $F = 50$  (i. e., 50 percent) determines

Unclassified

SECURITY ~~SECRET~~ INFORMATION 18522

Classified

the mean of the sample. If this mean is subtracted from the ordinate corresponding to abscissa  $F = 0.841$ , the difference is the estimated standard deviation of individual values about the mean of the sample.

Thus, the upper line in Fig. A33 indicates mean:  $\bar{x} = -0.5$  inch and standard deviation:  $S_x = 13.5$  in. These apply to the x coordinates of the points of Fig. A2. Similarly from the lower line in Fig. A33:  $\bar{y} = 16.0$  inches (y measured from bottom of screen in Fig. A2) and  $S_y = 15.0$  inches. The percentages (i. e., abscissae) for the points along the lower line of Fig. A33 were computed using as base (i. e., 100 percent) the total number of shots fired (i. e., 80 from Fig. A2), although of these (11/80) 14 percent were off the screen at the bottom. Thus, even though the distribution of y's is truncated at  $y = 0$  (bottom of screen), it is relatively simple to estimate the mean and the standard deviation through the use of probability paper which incidently facilities the calculation even for the nontruncated case.

On the other hand, if the distributions of x and y are statistically independent (as was the case of Fig. A1 for which the correlation between x and y did not significantly differ from zero) then, referring to Fig. A2, the mean and standard deviation of x will be independent of y. Hence, in computing the percentages (ordinates) for the upper set of points in Fig. A33, it was essential to use a base (i. e., 100 percent) equal to the number of shots on the screen (i. e., 69 from Fig. A2). That is to say, the distribution of the x's of Fig. A2 is not truncated, as was that of the y's; only the sample size for x is diminished as a consequence of some 11 shots having gone off the screen.

#### Summary of Means and Standard Deviation

Proceeding as described in the preceding paragraph, the means of x and y and their standard deviations were determined for each of the test results shown in Figs. A1 to A32. For Tests 1 and 2, the results are given respectively in Tables A1 and A2. Inspection of  $S_x$  and  $S_y$  (i. e., the standard deviations of x and y) in Tables A1 and A2 indicates on the whole no very great difference between  $S_x$  and  $S_y$ . More elaborate tests indicate the same conclusion. For example, in Test 1, Table 1, if  $S_x$  and  $S_y$  in the first four rows are each normalized to range 100 yd (on the assumption of constant mil error), and then the variance of x and y are separately pooled (from the results at the four ranges), the resulting  $S_x = 4.9$  inches and  $S_y = 5.8$  inches, a difference of only 18 percent. In other cases, for example, in Test 1 for marksmen

SECURITY ~~SECRET~~ INFORMATION

Unclassified

firing individually, ( $M_1$ , Table A1)  $S_x$  exceeds  $S_y$ . Hence, on the whole no serious consequences are likely to arise from assuming  $\sigma_x = \sigma_y$  for all the results ( $\sigma_x$ , and  $\sigma_y$  are standard deviations for the whole population).

Dispersion as a Function of Range

In the preceding paragraph, it was indicated that when the standard deviation in x (or y) at each of the four ranges was divided by the range, the results were essentially independent of range. It was also indicated that x and y were independent

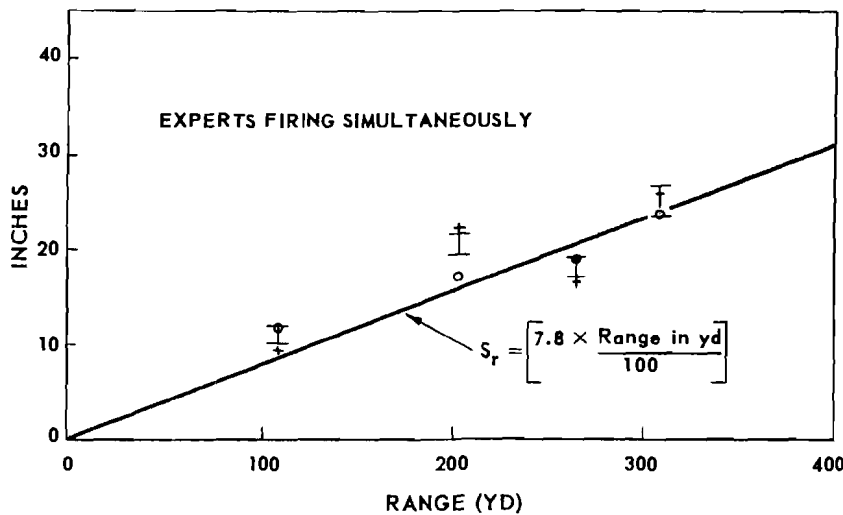
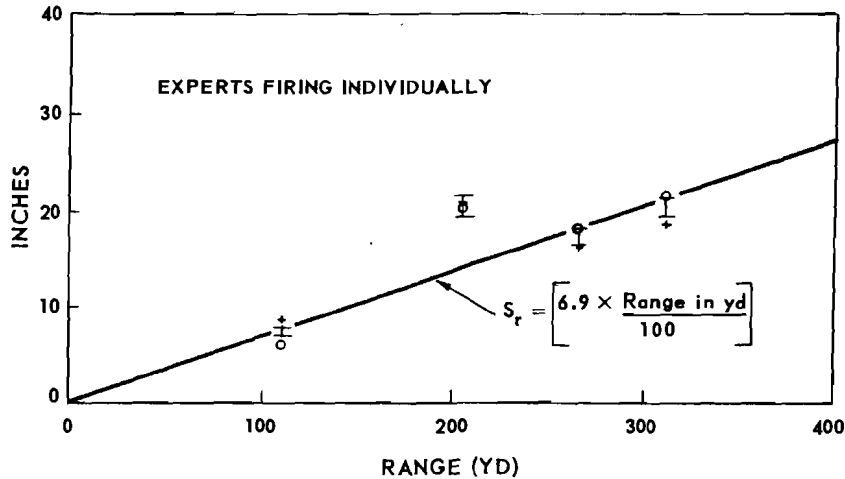

Fig. A34—Observed standard deviation,  $S_r$ , of distance of individual shots from mpi as function of target range, for experts.  $\circ$ , Test 1;  $+$ , Test 2;  $\bar{I}$ , centered at  $S_r$  from combined results of Tests 1 and 2. Total vertical extent of  $\bar{I}$  indicates range within which 50 percent of results from similar samples should fall.

Unclassified

~~SECRET~~ #18524

classified

(i. e., correlation zero) and that their standard deviations could be assumed equal. This suggests the standard deviation of  $r$  ( $r^2 = x^2 + y^2$ ) as a convenient measure of dispersion since it combines  $S_x$  and  $S_y$  (actually  $S_r^2 = S_y^2 + S_x^2$ ).

For Tests 1 and 2 respectively, values of  $S_r$  are listed in column 7 of Tables A1 and A2. In Figs. A34 and A35, these values of  $S_r$  are plotted as a function of range to target. It is evident in Figs. A34 and A35 that the "observed" values of  $S_r$  for the different ranges are, within the indicated statistical uncertainties, reasonably approximated by the indicated straight lines. This implies that the dispersion (standard deviation) in inches at the target increases linearly with the target range, according to the equations indicated. The constants show that, in accuracy, the riflemen rank in the following order: (1) experts firing individually, (2) experts firing simultaneously, (3) marksmen firing individually, and (4) marksmen firing simultaneously.

#### Systematic Errors in the mpi

Figure A36 indicates the vertical distance of the mpi from the top of the target, at the four ranges, for experts and marksmen in Tests 1 and 2. Even if all men aimed at the center of the target, vertical systematic deviations of the mpi from the aiming point would be expected as a consequence of the parabolic nature of the bullet trajectory. How the vertical coordinate of the mpi varies with range would depend on the range for which the sights are set. Figures A37 and A38 indicate for Tests 1 and 2, respectively, the x - coordinate of the mpi at different ranges. It is evident that in Test 1 the bias is quite small and in most cases probably not statistically significant. On the contrary, the bias in Test 2 is generally larger than in Test 1, particularly for marksmen, and is in many cases statistically significant. Results of tests for the significance of this bias are given in the last row of Tables A4, A5, A6, and A7, on which further comment will follow.

#### Comparison of Observed and Theoretical Distributions of Deviations from mpi

If  $x$  and  $y$  are deviations from a mean, and are independently and normally distributed with equal standard deviations,  $\sigma_x = \sigma_y$ , then it is convenient to consider the distribution of radial deviations,  $r$ , ( $r = x + y$ ), which have standard deviation,  $\sigma_r = (\sigma_x^2 + \sigma_y^2)^{1/2}$ . It can be shown that, of all the radial deviations

classified

Unclassified

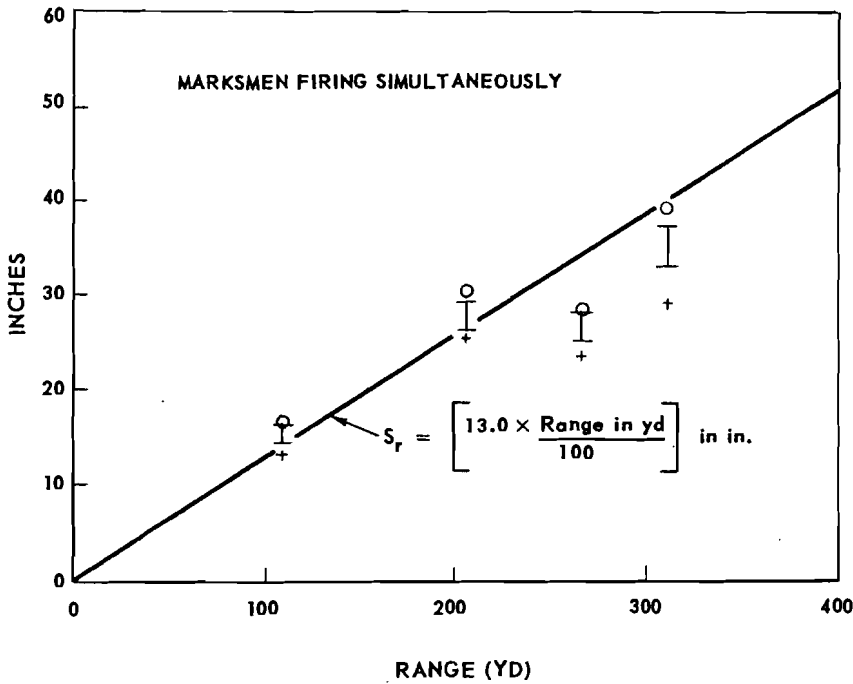
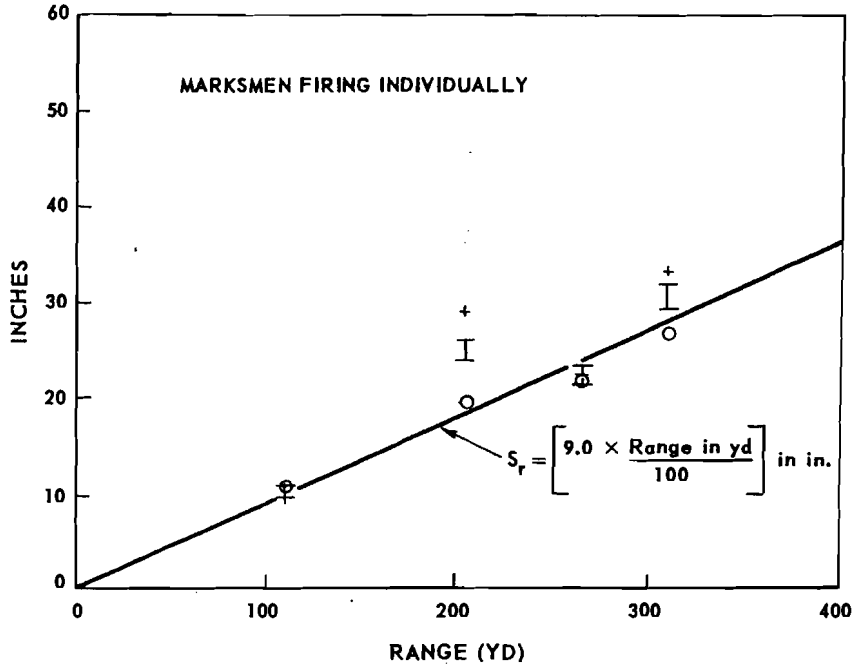

Fig. A35—Observed standard deviation,  $S_r$ , of distance of individual shots from mpi as function of target range for marksmen. For meaning of symbols see Fig. A34.

Unclassified

~~SECURITY INFORMATION~~ 18526

Unclassified

from the mean, the fraction having deviations greater than or equal to  $k\sigma_r$  is, on the average, given by:

$$W(k) = e^{-k^2} \quad (1)$$

or looked at in another way  $W(k)$  is the probability that a shot falls outside the circle of radius  $r = k\sigma_r$ . The following table indicates values of  $W(k)$  for a few selected values of  $k$ :

k	0.000	0.536	0.833	1.179	$\infty$
W (k)	1.000	0.750	0.500	0.250	0.000

In particular, the circle of radius  $0.833 \sigma_r$ , with  $W(k) = 0.500$ , is usually called the circular probable error (cpe). Thus circles of radii, 0,  $0.536 \sigma_r$ ,  $0.833 \sigma_r$ ,  $1.179 \sigma_r$ , and  $\infty$ , with centers at the mpi, divide the plane into four zones, such that the probability of a shot hitting within any one of the zones is 25 percent. These circles were drawn in each of the originals of Figs. A1 to A32, (but they are not reproduced here), and the radii of the circles bounding each zone are listed in Tables A4, A5, A6, and A7. These tables also indicate the expected and observed numbers of shots falling in each zone.

In several cases, such as illustrated in Fig. A4, parts of some or of all zones are off the screen. For these cases it is obviously impossible to indicate how those shots which did not hit the screen were distributed among the zones. In such instances only those shots observed to hit the screen can be properly allocated among the partial zones which are on the screen. The expected number of hits within the parts of zones which are on the screen is, however, computed from the total number of shots fired (72 in the case of Fig. A4). This was done using circular probability paper to facilitate the numerical integration to determine the probability of hits falling within the partial zones. Multiplying these probabilities by the total number of shots fired gave the expected number of hits in each partial zone.

Corresponding to each of Figs. A1 to A32, the discrepancy between the observed and expected number of hits in each of the four zones (or partial zones) was measured by  $\chi^2$ .  $P(\chi^2)$  in Tables A4, A5, A6, and A7 indicates the probability of obtaining, in similar samples, as bad or a worse fit between observation and expectation than that indicated in the Tables. For Test 1, the values of  $P(\chi^2)$  in Tables A4 and A5 are, in general, large enough so that the fit of the observed distribution to the theoretical one is acceptable. Thus, for subsequent calculations, the

Unclassified

~~SECURITY INFORMATION~~ SECRET



~~SECRET~~  
#18527

more convenient theoretical distribution can with confidence be used in place of the observed distribution. The discrepancy between the observed and theoretical distributions in Test 2 are on the whole greater than for Test 1.

Undoubtedly, this arises either from a large bias in the mpi for shots fired by some of the riflemen, or from nonhomogeneity in the dispersion for all the riflemen. However, as Figs. A34 and A35 indicate, the radial dispersions,  $s_r$ , are not very different in the two tests so that subsequent conclusions based on dispersion indicated by the straight lines (or equations) of Figs. A34 and A35, will not be much in error.

Remarks on the Homogeneity of Results for Individual Riflemen

Attempts were made to identify each bullet hole according to the man firing in the case of those tests in which men fired individually. In many cases, it turned out that holes were obviously improperly marked. Because of the small number of shots fired by each man, the results of individuals could be compared reliably only if the location of all shots fired was known. Thus, the comparison of individuals is limited to the situation of Figs. A1 and A9. The test for homogeneity consisted, in the case of Fig. A1, in counting the number of shots each individual fired inside and the number outside the probable error circle, and testing this against the expected number based on the results for all riflemen. The following table indicates the results for Fig. A1:

Man No.	1	2	3	4	5	6	7	8	9	10	11	12	Total
No. inside <sup>a</sup> p.e. circle	0	4	4	5	2	5	7	7	5	6	1	2	48
No. outside <sup>a</sup> p.e. circle	8	4	4	3	6	3	1	1	3	2	7	6	48

<sup>a</sup>The expected number throughout is 4.

Applying the  $\chi^2$  test,  $P = 0.003$ , for the hypothesis that there is no difference (in the long run) among the several individuals, the value of  $P$  indicates a likelihood of some difference among the individuals, which for subsequent purposes is not serious, mainly because some individuals (Nos. 1 and 11) appear worse than the average, while others (Nos. 7 and 8) appear better. This somewhat compensates, so that the distribution of all shots does not deviate seriously from the expected distribution

~~SECRET~~

~~SECRET~~

~~SECRET~~ INFORMATION 28

classified

(see  $P(\chi^2)$  Tables A4, A5, A6, and A7). Similar tests for the results in Fig. A9 are given in the following table:

Man No.	1	2	3	4	5	6	7	Total
No. inside <sup>a</sup> p.e. circle	1	4	5	4	7	2	4	27
No. outside <sup>a</sup> p.e. circle	7	4	3	4	1	6	4	29

<sup>a</sup>The expected number throughout is 4.

Here  $P(\chi^2) = 0.08$ , indicating no statistically significant departure from homogeneity of results for the seven individuals.

#### Remarks on Deviations of mpi from Aiming Point

In connection with Fig. A36, it is reasonable to expect some systematic vertical deviations in mpi with range; because of this, tests of the vertical deviation of the mpi from an aiming point were not made. However, deviations of the mpi to the right or left (x coordinate) from the vertical line through the center of the target were tested to determine whether they were large enough to be statistically significant. The results are shown in Tables A4, A5, A6, and A7 in which  $P(\bar{x})$  indicates the probability of obtaining (in further samples under similar circumstances) deviations of the mpi as great or greater than those actually observed. It is evident in Tables A4 and A5 that, in most cases, the deviations are not statistically significant. For Test 2 as shown in Tables A6 and A7 several small values of  $P$  were obtained. This indicates that many of the deviations are statistically significant, particularly since Table A2 and Fig. A37 show that all the mpi, in Test 2, deviated to the right ( $\bar{x}$ , positive). It should be mentioned, however, that if the mpi for some of the individual riflemen deviate significantly from the mpi averaged for all, then the deviations of single shots from the latter mpi are not statistically independent. Taking account of this would increase the values of  $P(\bar{x})$  in the Tables. In any case, the deviations of the mpi ( $\bar{x}$  in Tables A4 and A5) in Test 1 were not, in general, significant so that subsequent calculations will apply reasonably well to conditions of Test 1.

~~SECRET~~ INFORMATION

Unclassified

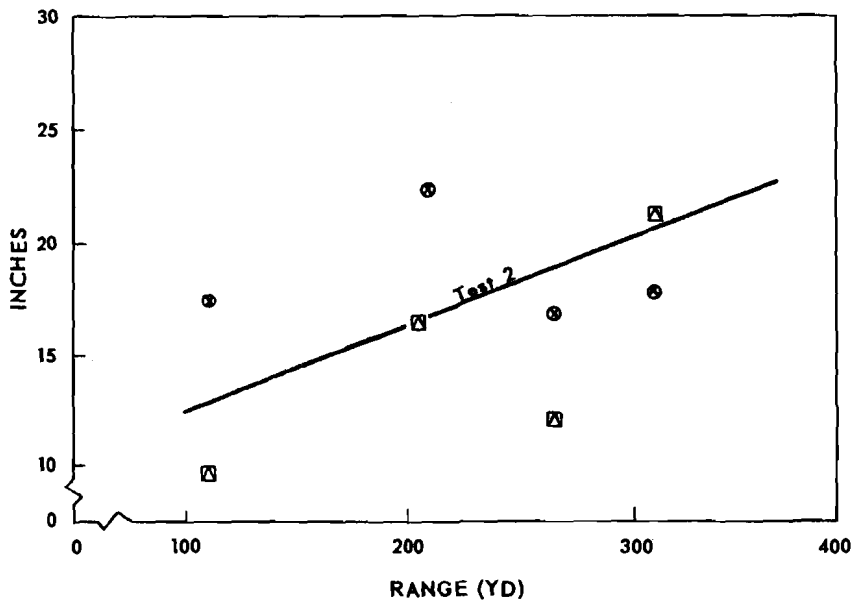
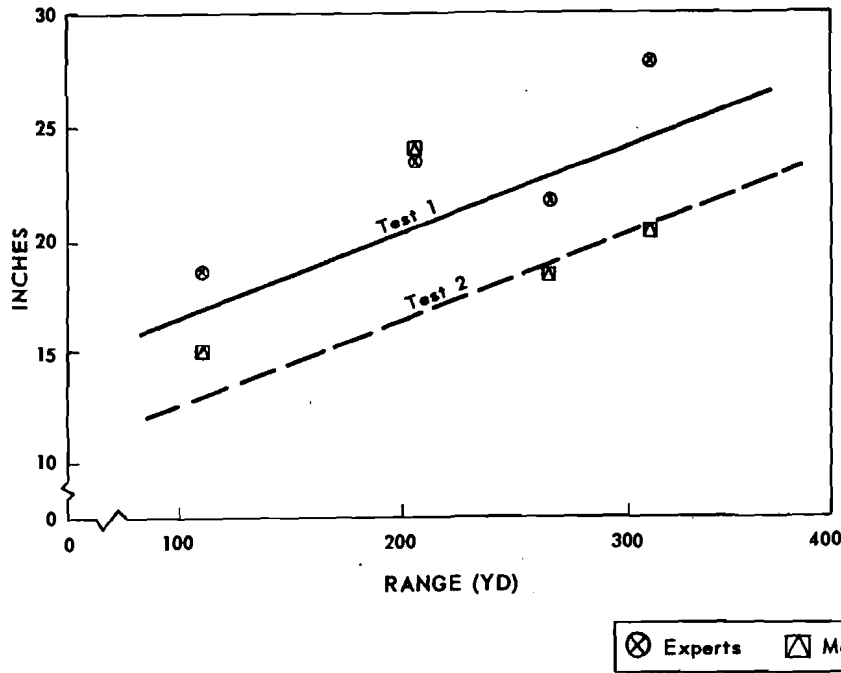

Fig. A36—Distance of mpi from top of target as function of range; combined individual and simultaneous firings of experts and marksmen; Tests 1 and 2.

Unclassified

~~SECURITY SECRET INFORMATION~~ #18530

unclassified

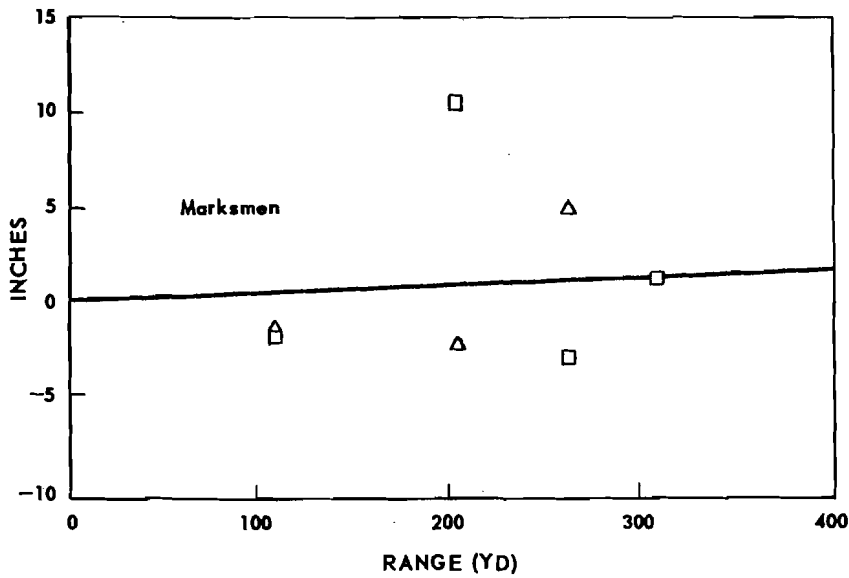
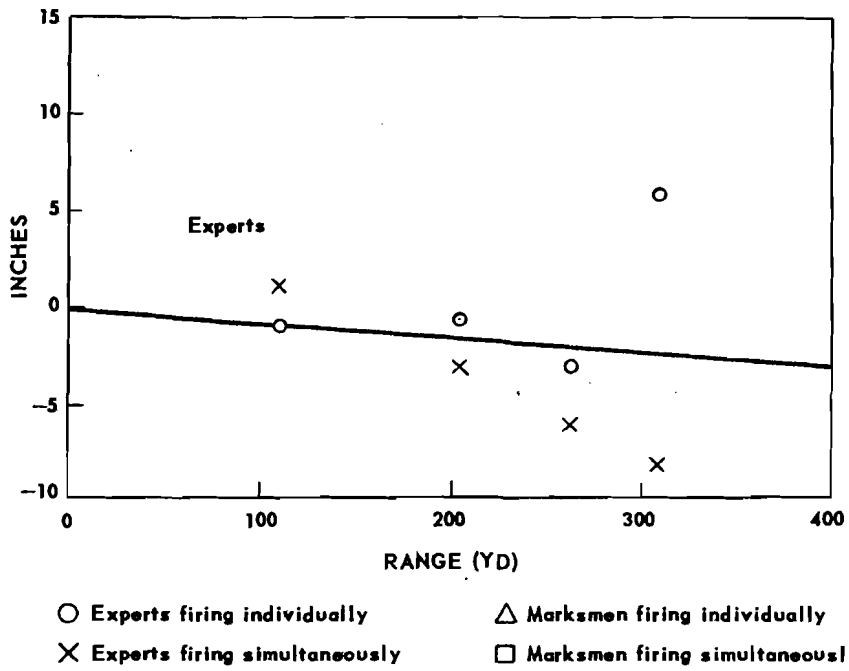

Fig. A37—Distance of mpi from vertical line through target center as function of range; marksmen and experts firing individually and simultaneously, Test 1.

unclassified

UNCLASSIFIED

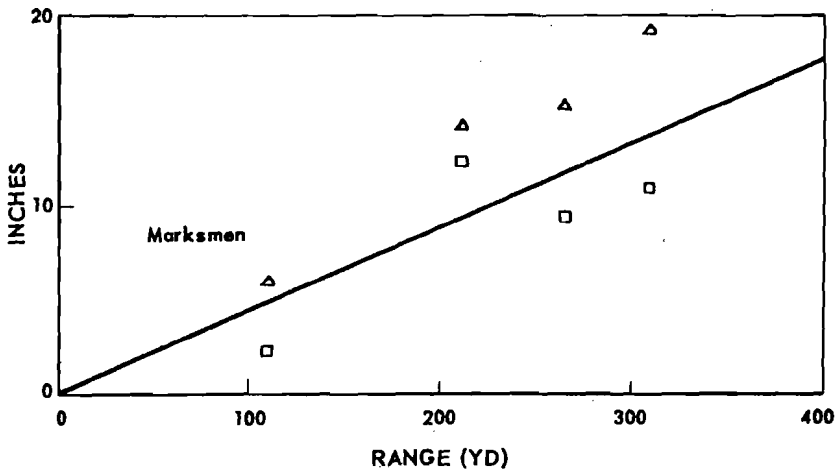
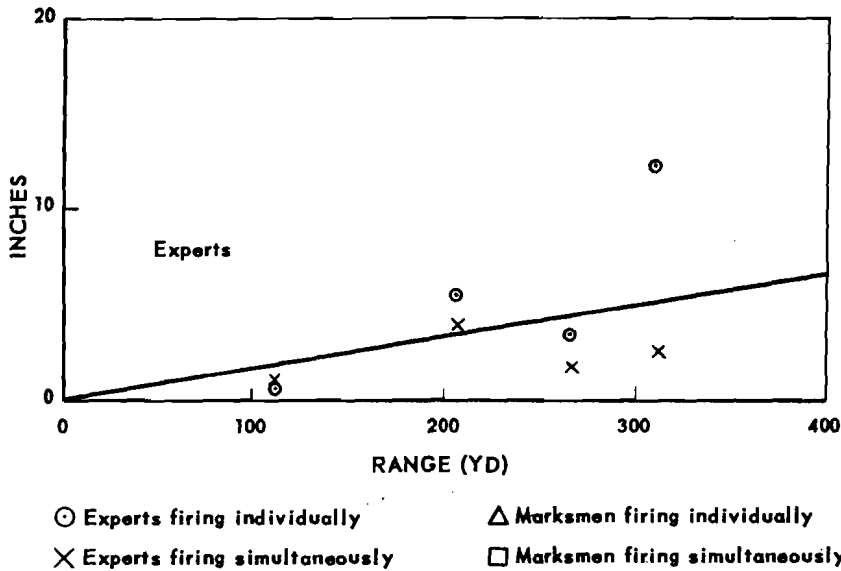

Fig. A38—Distance of mpi from vertical line through target center as function of range; marksmen and experts firing individually and simultaneously, Test 2.

UNCLASSIFIED

SECURITY ~~SECRET~~ INFORMATION #18532

Unclassified

Comparison of Observed and Theoretical  
Probabilities of Hitting Target at Various Ranges

Figures A39 and A40 compare the observed and theoretical probabilities of hitting the target at different ranges under the several conditions involved in Tests 1 and 2. The observed probabilities are, of course, just the percentage hits on the target, from Fig. A1 to A32. The theoretical probabilities, shown by the curves of Figs. A39 and A40 were computed on the basis of the following model: (a) The target was assumed to have the shape and dimensions shown in the accompanying sketch:

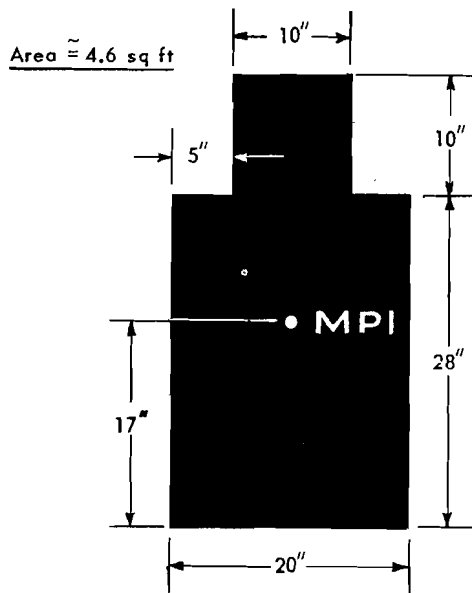

The location of the assumed mpi for all ranges is shown; it is on the vertical center line through the target. (b) The standard deviation of radial deviations, for any particular range, was assumed to be that given by the lines (or equations) in Figs. A34 and A35.

Tests show that the deviations of some of the "observed points" from the curves, in Figs. A39 and A40, are statistically significant. These deviations are generally below the curve. In Fig. A40, for example, all the crosses in the upper figure fall below the curve. Examination of Table A2 indicates that the mpi (the  $\bar{x}$ 's in the Table) were all to the right of the vertical center line through the target; moreover, the small values of  $P(\bar{x})$  in Table A7 indicate that these deviations of the

SECURITY ~~SECRET~~ INFORMATION

Unclassified

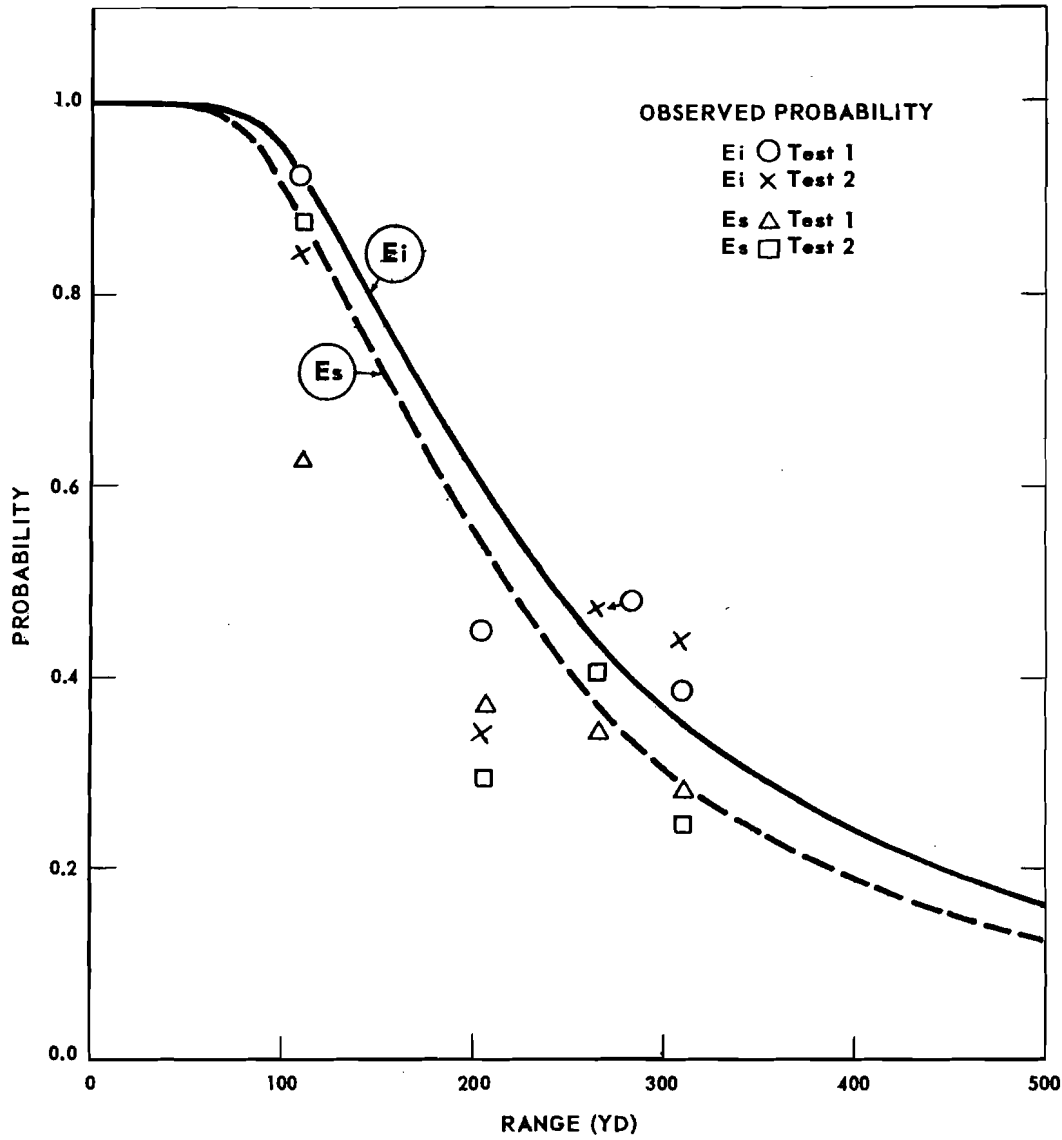

Fig. A39—Probability of expert riflemen hitting Type E silhouette of range. Ei: firing individually; Es: firing simultaneously.

Unclassified

~~SECRET~~ INFORMATION #18534

Unclassified

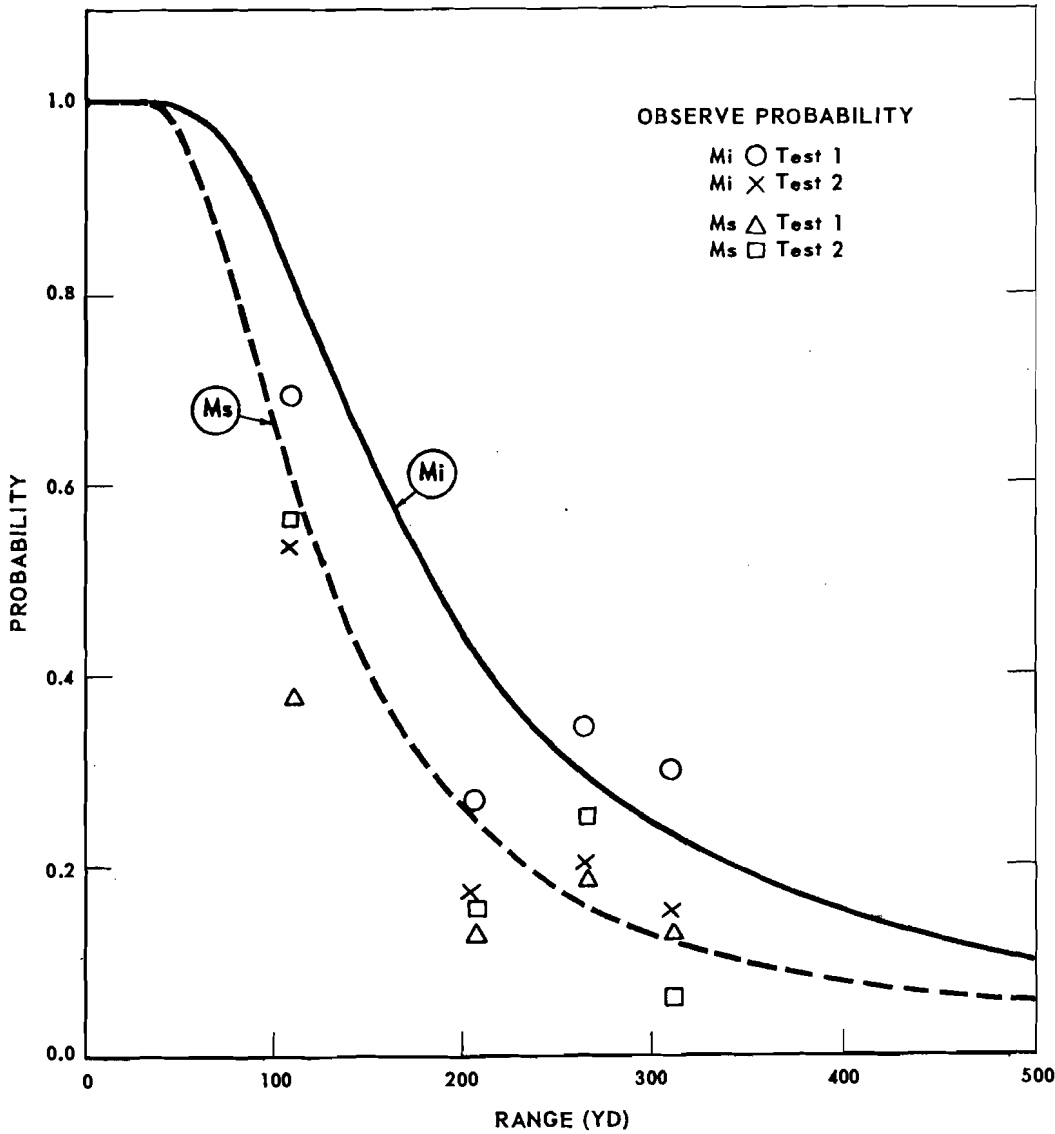

Fig. A40—Probability of marksmen hitting Type E silhouette target as a function of range. Mi: firing individually; Ms: firing simultaneously.

Unclassified

~~SECRET~~



~~SECURITY SECRET INFORMATION~~  
#18535

Unclassified

mpi from the center line were statistically significant. Nevertheless, the curves give a fair approximation to observed results, at least for Test 1. In fact, the differences between the theoretical probabilities of hit and those observed in Test 1 are, in general, comparable with the differences between the observed probabilities in Test 1 and those observed in Test 2. At the range of 205 yd, all the observed points fall below the curves. In Figs. A34 and A35 it may also be seen that the observed standard deviations obtained for range 205 yd, appear to be consistently high. Observers at the firing range indicated that the target appeared to be as far away as that at 265 yd. This may have been an illusion due to some bushes close to the line of sight. If sufficient data were available to determine from a large number of samples the nature of the distribution of mpi, this could be used in the determination of theoretical probabilities. In any case, the theoretical curves and the hypotheses on which they were derived provide a convenient and sufficiently good basis on which to compare probabilities of hitting targets with a single-shot weapon and a hypothetical one which fires several shots simultaneously in a pattern.

Remarks on Results of Firing on Targets  
Appearing Randomly at Either of Two Ranges

Table A3 indicates the results obtained when the target (type E silhouettes) appeared randomly, and for 1 sec., at either of two ranges (110 yd or 265 yd) as described in the introduction. Due to the small number of rounds fired and especially to the very small number of hits on the target, inspection of Table A3 indicates that for any particular range the differences between the percentage hits on the target are not statistically significant for experts firing individually ( $E_i$ ) compared to experts firing simultaneously. For Test 3 the same conclusion obtains for marksmen. Thus, from Table A3 the results  $E_i$  and  $E_s$  were combined for each of the two ranges; results for  $M_i$  and  $M_s$  were similarly combined. When the combined results for experts in Test 3 at range 110 yd were compared with the results of experts firing simultaneously from Tests 1 and 2, at 110 yd, the percentage hits on the target were definitely less in Test 3, and the difference was found to be statistically significant. Similarly, the combined results for experts in Test 3 at 265 yd indicated a significantly lower percentage hits than that obtained from the combined results, in Tests 1 and 2, of experts firing

~~SECURITY SECRET INFORMATION~~

~~SECURITY~~ **SECRET** ~~INFORMATION~~ #18536

simultaneously at range 265 yd. That is, as would be anticipated, the accuracy of expert riflemen for the same range was much less under the conditions of Test 3 than under the conditions of Tests 1 and 2. For the marksmen, the results from Test 3 were not statistically different from those of Tests 1 and 2 at the same ranges.

## APPLICATION

### Theoretical Probability of Hitting Type E Silhouette Target With a Salvo Pattern

In the same way that the results of the present analysis were used to compute the curves of Figs. A39 and A40, they may also be used to obtain the variation, with range, of the probability of hitting the target with a salvo pattern. In Fig. A41, the curves  $M_s(1)$  and  $E_i(1)$  are respectively the curves  $M_s$  of Fig. A40, and  $E_i$  of Fig. A39. The curves  $M_s(1)$  and  $E_i(1)$  were obtained for the target, sketched previously, in the following way: The right half of the target can be considered made up of two rectangles: one 5 in. x 38 in., and the other 5 in. x 28 in.; with A as mean, the independent probabilities of x and y falling inside each of the rectangles are readily found from tables of the probability integral since the standard deviations of x and y are known for any range; for each rectangle the product of the two probabilities gives, of course, the probability of both x and y being in the rectangle; summing over both rectangles and multiplying by 2 gives the probability of hitting the target.

In Fig. A41, the curves  $E_i(2)$  and  $M_s(2)$  were computed for the five-shot pattern drawn as it would hit a screen at 300 yd range. It was assumed that there was no statistical dispersion in the position (at the target) of any one of the individual missiles relative to the others. It was also assumed that the "spread" of the pattern was proportional to range. The dispersion of the center missile (the others in the pattern remain fixed relative to the center missile) at the target was assumed to be the same as that used in computing the curves  $E_i(1)$  and  $M_s(1)$ , i. e., that derived from the analysis of the aiming errors obtained in the tests. For each range a "virtual target" was drawn such that if the aimed round of the pattern (i. e., the central one) fell inside the boundary of the virtual target then at least one missile hit the target. Except for the fact that the "virtual target" was somewhat more complex in shape, the procedure used to obtain

~~SECURITY~~ **SECRET** ~~INFORMATION~~

Unclassification

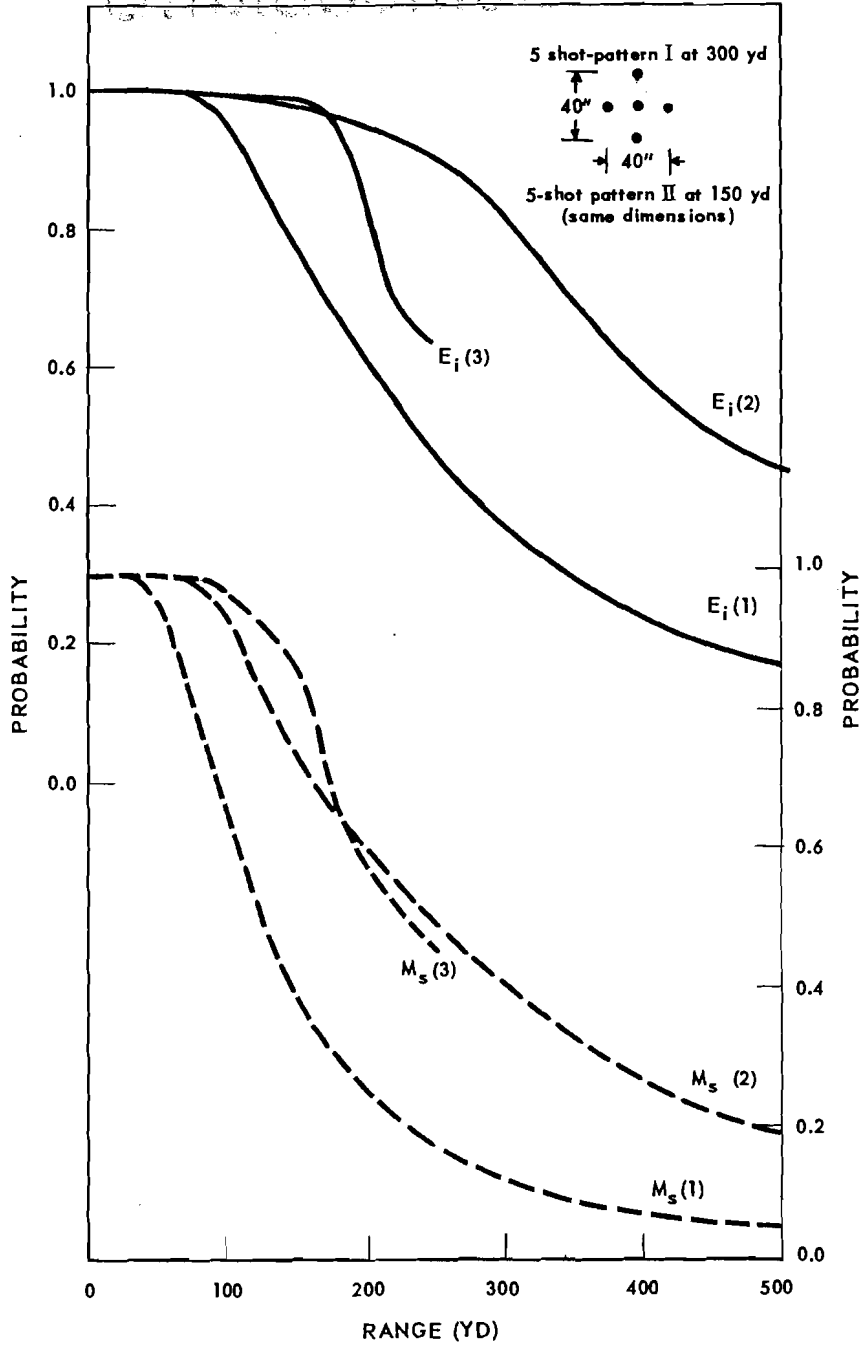

Fig. A41—Probability of hitting E type silhouette target with single shot compared with probability of at least one hit with a five-shot pattern salvo; curves based on aiming errors.  $E_i$ : experts firing individually;  $M_s$ : marksmen firing simultaneously; (1) with single shot; (2) at least one hit with five-shot pattern I; (3) at least one hit with five-shot pattern II.

Unclassification

SECURITY ~~SECRET~~ INFORMATION #18938

Unclassified

the probability of obtaining at least one hit was the same as that described above for single shots (i. e., no pattern).

The curves  $E_i(3)$  and  $M_s(3)$  were similarly computed for the same shape of salvo pattern, but for a pattern with half the spread (at any given distance) as that used for  $E_i(2)$  and  $M_s(2)$ . From Fig. A41 it is evident that, of the two shot patterns, the one with the greater spread has the over-all advantage over ranges up to 300 yd. Incidentally, the probability of at least one hit, on type E silhouette, indicated by curves  $E_i(2)$  and  $M_s(2)$ , Fig. A41, for ranges up to 225 yd applies also to the four-shot pattern resulting from removal of the center shot from pattern I. Curves  $E_i(3)$  and  $M_s(3)$  apply also to the four-shot pattern resulting from the removal of the central bullet of pattern II.

#### Probabilities for 1, 2, 3, 4, and 5 Hits

##### on Man-Size Target With Five-Shot Pattern Salvo

The probabilities of 1, 2, 3, 4, and 5 bullets hitting a target are given in Tables A8 and A9 for marksmen and for experts individually firing a five-shot pattern salvo. The target, type E silhouette, is that sketched previously. The shot pattern used in the calculations is pattern I as sketched in Fig. A41. It should be noted that, in the case of multiple hits, the individual hits are not located at random relative to each other. This follows from the assumptions stated previously to the effect that on arrival at the target the relative positions of all missiles in the pattern are fixed, with the dimensions of the pattern proportional to range.

#### Comparison of Theoretical Probabilities of Hitting

##### "Average Target" with Single-Shot and Five-Shot Pattern Salvo

At the eye of a rifleman, the solid angle subtended by the average human target in combat is less than that subtended by the type E silhouette.<sup>1</sup> For the approximation to the average target a rectangle (for convenience in calculation) 20 in. x 12 in. was chosen and designated target A (see Fig. A42). The probability of hitting target A as a function of range was computed giving the results shown by the curves in Fig. A42. These curves indicate that the probability of at least one hit with the five-shot pattern salvo is decidedly greater, for the same range, than the probability of hitting with a single shot. If the central bullet is removed from

<sup>1</sup>ORO-R-5

Unclassified

SECURITY ~~SECRET~~ INFORMATION

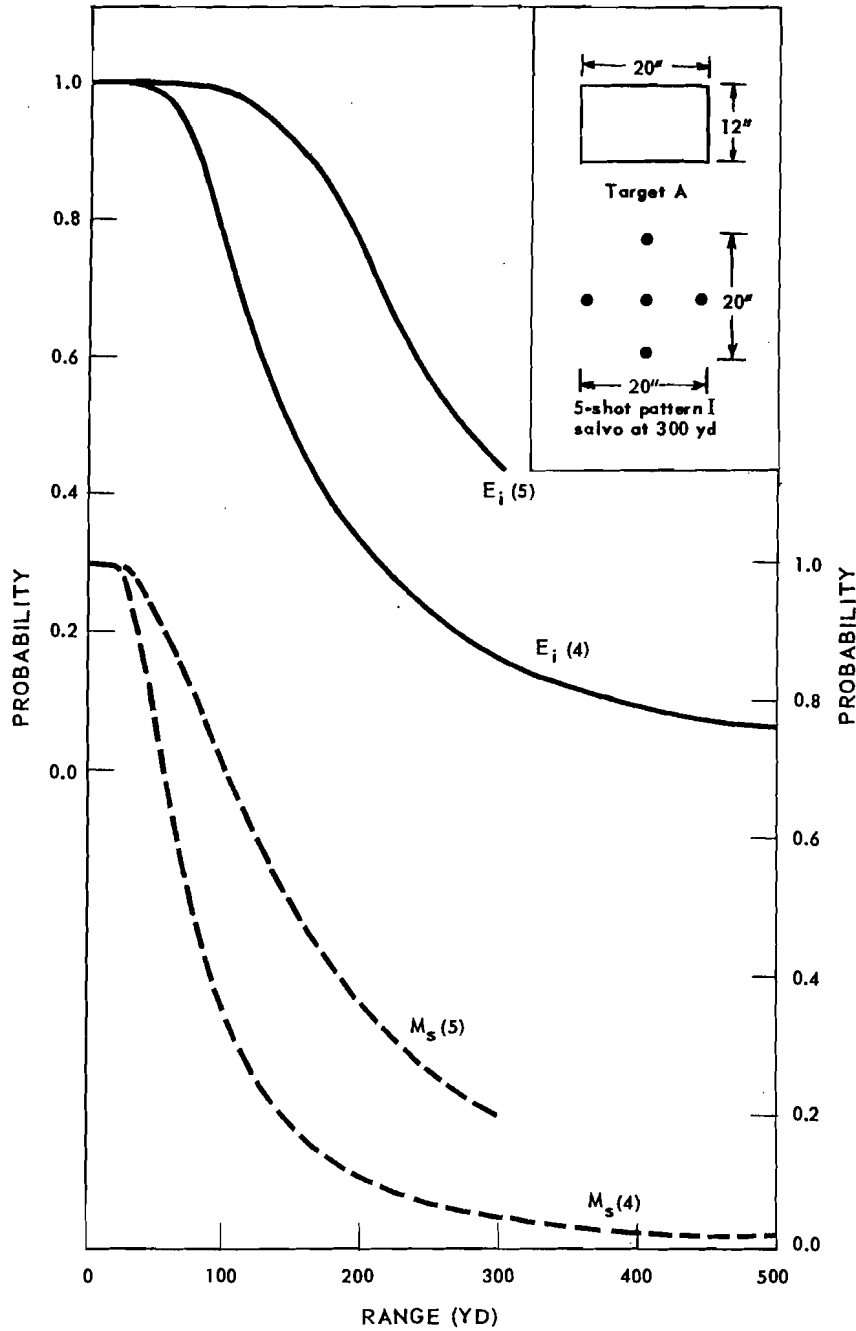

Fig. A42—Probability of hitting “average” target, A, (sketched in box) with single shot compared with probability of at least one hit on target with five-shot pattern salvos.  $E_i$ : experts firing individually;  $M_s$ : marksmen firing simultaneously; (4) with single shot; (5) at least one hit on target with five-shot pattern I.

~~SECURITY SECRET INFORMATION~~

the five-shot pattern the probability of at least one hit on target A is unaffected at ranges less than 150 yd.

Remarks on Significance of Probabilities of Hitting a Target with a Single-Shot and with Five-Shot, Four-Shot Pattern Salvos

Although the probability of at least one hit on the target is, at the same range, greater for one five-shot pattern salvo than for a single shot, it is less than the probability of at least one hit on the target for five separately aimed single shots. Consider, for example, the comparison at 200 yd range for the upper curves in Fig. A42. For the five-shot pattern, curve  $E_i(5)$  indicates at 200 yd a probability of about 0.74 for at least one hit. For one single shot, curve  $E_i(4)$  indicates about 0.32 for the hit probability. The probability of at least one hit in five single-shot trials is then:  $(1 - 0.68^5) \doteq 0.85$  which is somewhat greater than the probability of 0.74 for at least one hit for the five-shot pattern.

Consider also the case for range 150 yd for target A. The curve  $E_i(4)$  of Fig. A42 shows for range 150 yd a probability of 0.49 for hitting target A. Curve  $E_i(5)$  indicates 0.90 for the probability of at least one hit using the five-shot pattern. As indicated in the preceding section, the probability of at least one hit for the four-shot pattern (central one of the five-shot pattern removed) is, for ranges less than 150 yd, the same as for the five-shot pattern. Thus, the probability of at least one hit, in this case, from five single shots is  $(1 - 0.51^5) = 0.97$  which is slightly greater than that for at least one hit from a single five-shot pattern salvo. However, if we use a four-shot pattern we find  $(1 - 0.51^4) = 0.93$  for the probability of at least one hit from four single shots compared to 0.90 for the probability of at least one hit from the four-shot pattern. Thus, for targets which may remain in the rifleman's view only long enough for him to aim once, the advantages of the five-shot pattern salvo are evident.

Effect of Weapon Dispersion on Probability of Hitting Target

In order to determine the effect of weapon dispersion (the dispersion at the target when the rifle is rigidly fixed) on the probability of hitting the target, it is necessary to determine the standard deviation due only to aiming. From the firing test data the total standard deviation,  $\sigma_r$ , at the target was found to be proportional to the range, that is

$$\sigma_r = cr \text{ in.} \quad (1)$$

with  $r$  the range in units of 100 yd.

~~SECURITY SECRET INFORMATION~~

~~SECRET~~  
UNCLASSIFIED

Let  $\sigma_w$  represent the standard deviation due to weapon dispersion (i. e., standard deviation of shot distances from mpi). Now the standard deviation at the target, due only to weapon dispersion, will also be proportional to the range  $r$ , then:

$$\sigma_w = \alpha r \text{ in.} \quad (2)$$

Also the standard deviation,  $\sigma_A$ , due to aiming errors only (i.e., no weapon-ammunition dispersion) will be proportional to the range, thus:

$$\sigma_A = A r \text{ in.} \quad (3)$$

Since deviations from the mpi due to aiming errors and to weapon-ammunition errors are independent, than at a particular range:

$$\sigma_r^2 = \sigma_A^2 + \sigma_w^2 \quad (4)$$

or for any range  $r$ :

$$c^2 r^2 = A^2 r^2 + \alpha k^2 r^2 \quad (5)$$

Tests on the M-1 rifle indicate that  $\alpha = 2.3$  in.; that is, the standard deviation of shot distances from the mpi, for a rigidly held rifle, is 2.3 in. at 100 yd. (i.e.,  $r = 1$ ), including dispersion due to ammunition. This determines  $A$  in Equation 5 when  $c$  is known. From Table A5 the value of  $c$  is 9.0 in. for marksmen firing individually. For this case, and using  $\alpha = 2.3$  in., Equation 5 determines  $A = 76$ . Thus for other weapon dispersions,  $k \times 2.3$ , the variance  $\sigma_r^2$  of the combined errors due to weapon-ammunition and aiming is given by:

$$\sigma_r^2 = r^2 (76 + 5k^2) \quad (6)$$

Consider target A which, as previously described, is a rectangle 20 in. x 12 in. The probability of hitting this target (mpi at center) is, to a degree of approximation sufficient for present purposes, the probability of hitting a circular target with the same area. Thus, for convenience in estimating the effect of weapon dispersion on probability of hitting, consider the circular target with radius  $a$  such that  $\pi a^2 = 240 \text{ in.}^2$ , (12 in. x 20 in.) from which  $a^2 = 76.5$  ( $a = 8.75$  in.). For the mpi at the center of the circle, the probability,  $P_m$ , of missing the target (i. e., of shots falling outside the circle of radius  $a$ ) is:

$$P_m = e^{-a^2/\sigma_r^2} = e^{-76.5/r^2(76 + 5k^2)} \quad (7)$$

for marksmen firing individually. The three lines designated  $M_i$  in Fig. A43 are the curves of Equation (7) for each of three values

UNCLASSIFIED

~~SECRET~~ #18542

Unclassified

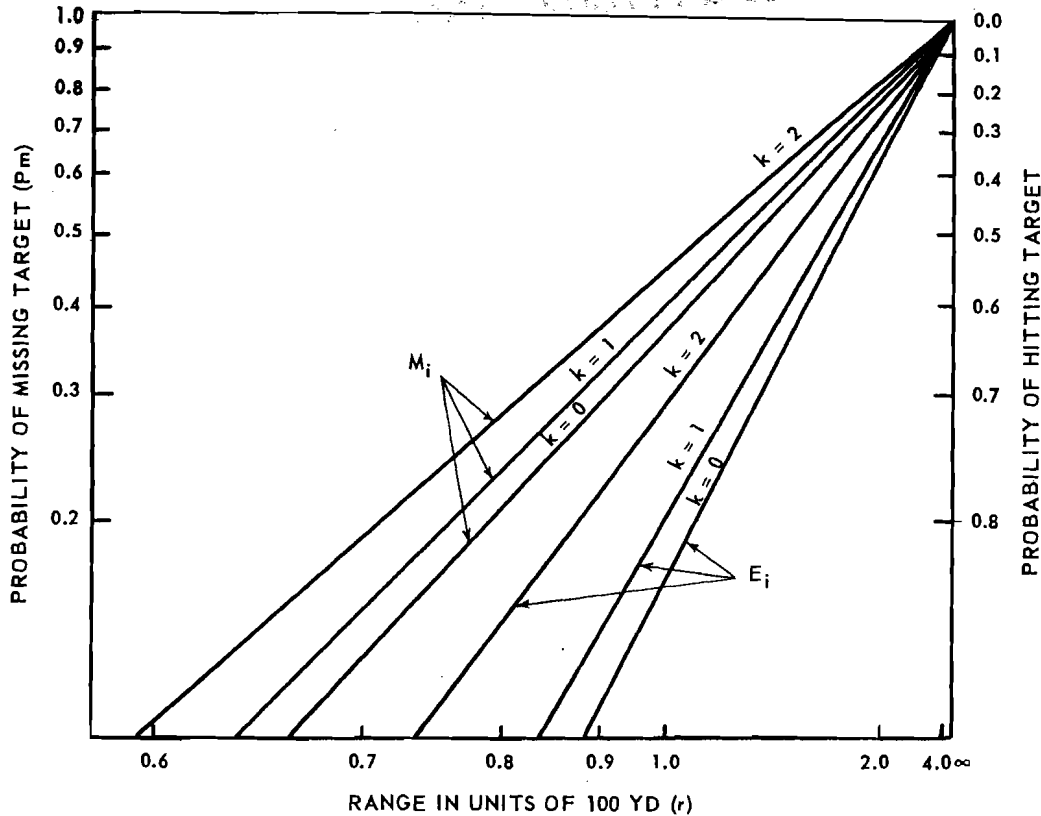

Fig. A43—Probability of hitting a circular target of area = 240 sq in. (radius = 8.75 in.) as a function of range for several weapon-ammunition errors. Plotted for marksmen firing individually, M<sub>i</sub>; and experts firing individually, E<sub>i</sub>. k is a selected multiple of the standard deviation of the strike from the mpi, as caused by weapon and ammunition alone. Thus k = 1 represents actual performance with issue rifle and ammunition, k = 0 shows performance with perfect weapons and ammunition, and k = 2 indicates performance with weapons and ammunitions giving double the actual standard deviation.

of k. From these curves (M<sub>i</sub>) it will be seen that the probability of hitting for K = 0 (i.e., no weapon-ammunition dispersion) is only slightly less than k = 1 (i.e., for the actual dispersion of the M-1 rifle and ammunition). Also, the curves for k = 2 indicate probabilities of hitting which are still not significantly less than those for a dispersionless rifle and ammunition (k = 0). The four lower curves (E<sub>i</sub>) in Fig. A43 apply to experts firing individually, for which the equation is:

$$P_m = e^{-a^2/\sigma_r^2} = e^{-76.5/r^2(42.5 + 5k^2)} \quad (8)$$

Equation 8 is obtained in the same manner as Equation 7 starting with the value of 6.9 in. for c, obtained from Table A4 for experts firing individually.

Unclassified



TABLE A1  
RIFLE RANGE TEST 1

Men	Range, yd	$\bar{x}$ , in.	$\bar{y}$ , in.	Std. Deviation, in.			No. Men Firing	Rounds per man	Total Rounds	No. Rounds	
				x	y	r				Target	Screen
E <sub>i</sub> <sup>a</sup>	110	- 0.9	13.5	4.1	5.2	6.4	12	8	96	88	96
	205	- 0.5	16.0	13.5	15.0	20.2	10	8	80	36	69
	265	- 3.0	19.5	13.0	13.0	18.4	9	8	72	34	62
	310	+ 6.0	7.0	12.6	17.8	21.8	9	8	72	28	47
E <sub>s</sub> <sup>b</sup>	110	+ 1.2	8.7	4.1	11.2	11.9	8	4	32	20	24
	205	- 2.8	15.6	11.0	12.8	16.9	8	4	32	12	26
	265	- 5.9	11.0	8.4	17.2	19.1	8	4	32	11	21
	310	- 8.2	10.0	15.0	18.3	23.7	8	4	32	9	19
M <sub>i</sub> <sup>c</sup>	110	- 1.7	16.4	8.7	6.4	10.8	7	8	56	39	56
	205	- 2.0	15.2	13.0	14.5	19.5	9	8	72	19	58
	265	+ 4.8	18.3	17.2	14.0	22.2	9	8	72	25	65
	310	- 1.0	14.8	24.0	12.2	26.9	10	8	80	24	61
M <sub>s</sub> <sup>d</sup>	110	- 1.8	14.2	14.2	9.0	16.8	8	4	32	12	30
	205	+ 10.5	11.8	23.0	20.2	30.6	8	4	32	4	19
	265	- 2.5	31.5	25.1	13.9	28.7	8	4	32	6	32
	310	+ 1.0	17.2	36.0	15.8	39.3	8	4	32	4	25

<sup>a</sup>E<sub>i</sub> - Expert Riflemen Individually Firing at Target.  
<sup>b</sup>E<sub>s</sub> - Expert Riflemen Simultaneously Firing at Target.

<sup>c</sup>M<sub>i</sub> - Marksmen Individually Firing at Target.  
<sup>d</sup>M<sub>s</sub> - Marksmen Simultaneously Firing at Target.

SECURITY INFORMATION

ORO-T-160

TABLE A2  
RIFLE RANGE TEST 2

Men	Range, yd	$\bar{x}$ , in.	$\bar{y}$ , in.	Std. Deviation, in.			No. Men Firing	Rounds per man	Total Rounds	No. Rounds	
				x	y	r				Target	Screen
E <sub>i</sub> <sup>a</sup>	110	+ 0.6	15.4	5.2	6.9	8.6	12	8	96	81	91
	205	+ 5.7	18.0	14.8	14.5	20.7	8	8	64	22	45
	265	+ 3.4	14.1	9.4	13.1	16.1	8	8	64	30	56
	310	+ 12.5	23.5	13.5	13.1	18.8	10	8	80	35	77
E <sub>s</sub> <sup>b</sup>	110	+ 0.8	20.5	2.8	9.3	9.7	8	4	32	28	28
	205	+ 3.9	23.0	17.1	14.3	22.3	16	4	64	19	58
	265	+ 1.7	17.0	10.1	12.8	16.3	8	4	32	13	28
	310	+ 2.5	13.9	21.5	14.1	25.7	8	4	32	8	25
M <sub>i</sub> <sup>c</sup>	110	+ 5.8	23.4	6.8	7.1	9.8	8	8	64	34	64
	205	+ 14.1	26.6	23.1	17.9	29.2	9	8	72	12	59
	265	+ 15.2	20.2	19.5	11.4	22.6	12	8	96	19	88
	310	+ 19.1	17.0	24.1	23.3	33.5	10	8	80	12	61
M <sub>s</sub> <sup>d</sup>	110	+ 2.2	26.7	10.5	8.1	13.3	8	4	32	18	29
	205	+ 12.1	24.5	18.5	18.0	25.8	16	4	65 <sup>e</sup>	10	49
	265	+ 9.2	14.4	12.7	20.1	23.8	8	4	32	8	24
	310	+ 10.8	21.3	17.2	23.7	29.3	8	4	32	2	26

<sup>a</sup>E<sub>i</sub> - Expert Riflemen Individually Firing at Target.  
<sup>b</sup>E<sub>s</sub> - Expert Riflemen Simultaneously Firing at Target.  
<sup>c</sup>M<sub>i</sub> - Marksmen Individually Firing at Target.

<sup>d</sup>M<sub>s</sub> - Marksmen Simultaneously Firing at Target.  
<sup>e</sup>One Man Fired Five Rounds.

ORO-T-160

SECURITY INFORMATION

100 MISSISSIPPI

**TABLE A3**  
**RIFLE RANGE TEST 3.**  
**FIRING AT TARGETS NO. 1 AND NO. 3 ALTERNATELY ON RANDOM SCHEDULE**

Men	Range, yd	$\bar{x}$ , in.	$\bar{y}$ , in.	Std. Deviation, in.			No. Men Firing	Rounds per man	Total Rounds	Number Rounds	
				x	y	r				Not Expend.	On Target
E <sub>i</sub> <sup>a</sup>	110	- 4.4	16.8	20.2	21.4	29.4	4	4	15	1	4
	265	0.0	23.0	20.0	15.9	25.6	4	4	16	0	1
E <sub>s</sub> <sup>b</sup>	110	+ 4.0	7.9	18.0	11.3	21.3	4	4	11	5	2
	265	+ 4.0	- 8.0	21.0	24.8	32.5	4	4	16	0	0
M <sub>i</sub> <sup>c</sup>	110	- 1.8	16.7	13.4	8.7	16.0	4	4	14	2	7
	265	- 1.4	6.9	41.1	23.5	47.3	4	4	15	1	1
M <sub>s</sub> <sup>d</sup>	110	- 10.8	13.0	11.6	15.4	19.3	4	4	13	3	4
	265	- 2.7	- 7.0	15.4	19.5	24.8	4	4	16	0	3

<sup>a</sup>E<sub>i</sub> - Expert Riflemen Individually Firing at Target.

<sup>b</sup>E<sub>s</sub> - Expert Riflemen Simultaneously Firing at Target.

<sup>c</sup>M<sub>i</sub> - Marksmen Individually Firing at Target.

<sup>d</sup>M<sub>s</sub> - Marksmen Simultaneously Firing at Target.

~~SECRET~~ INFORMATION

ORO-T-160

SECURITY ~~SECRET~~ #18546

TABLE A4

COMPARISON OF OBSERVED NUMBER OF SHOTS INSIDE ZONES BOUNDED BY CIRCLES OF RADII  $r_1$ , AND  $r_2$ , IN., WITH NUMBER EXPECTED FROM BIVARIATE DISTRIBUTION WITH RADIAL STANDARD DEVIATION  $\sigma_r$ ; AT FOUR RANGES, R, IN YD: TEST 1

(A) Experts Individually  $\sigma_r = 6.9 R/100$  ( $\sigma_r$  in in.)  
 $(\sigma_x = \sigma_y = 4.87 R/100, \text{ in.})$

R (yd)		110		205				265				310				
$\sigma_r$		7.6		14.1				18.3				21.4				
Zone	No. in Zone		Zone	No. in Zone		Zone	No. in Zone		Zone	No. in Zone		Zone	No. in Zone			
$r_1$	$r_2$	Obsd	Exptd	$r_1$	$r_2$	Obsd	Exptd	$r_1$	$r_2$	Obsd	Exptd	$r_1$	$r_2$	Obsd	Exptd	
0	4.1	25	24	0	7.6	15	20	0	9.8	23	18	0	11.5	20 <sup>d</sup>	16 <sup>d</sup>	
4.1	6.3	28	24	7.6	11.7	14	20	9.8	15.2	19	18	11.5	17.8	12 <sup>d</sup>	12 <sup>d</sup>	
6.3	9.0	23	24	11.7	16.6	18	20	15.2	21.6	12	18	17.8	25.2	8 <sup>d</sup>	11 <sup>d</sup>	
9.0	$\infty$	20	24	16.6	$\infty$	33	20	21.6	$\infty$	18	18	(25.2 B) <sup>b</sup>		7 <sup>d</sup>	11 <sup>d</sup>	
On Screen	96			69				62				47				50
Off Screen	0			11 <sup>a</sup>				10 <sup>a</sup>				25 <sup>c</sup>				22 <sup>c</sup>
Total	96	96			80				80	72				72	72	
$P(\chi^2)$	0.75			0.01				0.25				0.5				
$P(\bar{x})$	0.10			0.66				0.05				10 <sup>-4</sup>				

(B) Experts Simultaneously  $\sigma_r = 7.8 R/100$  ( $\sigma_r$  in in.)  
 $(\sigma_x = \sigma_y = 5.51 R/100, \text{ in.})$

R (yd)		110		205				265				310				
$\sigma_r$		8.6		16.0				20.7				24.2				
Zone	No. in Zone		Zone	No. in Zone		Zone	No. in Zone		Zone	No. in Zone		Zone	No. in Zone			
$r_1$	$r_2$	Obsd	Exptd	$r_1$	$r_2$	Obsd	Exptd	$r_1$	$r_2$	Obsd	Exptd	$r_1$	$r_2$	Obsd	Exptd	
0	4.6	9	8	0	8.6	8	8	0	11.1	7 <sup>d</sup>	8	0	13.0	5 <sup>d</sup>	8 <sup>d</sup>	
4.6	7.1	5	8	8.6	13.3	7	8	11.1	17.2	7 <sup>d</sup>	6 <sup>d</sup>	13.0	20.1	7 <sup>d</sup>	6 <sup>d</sup>	
7.1	10.1	4	8	13.3	18.9	5	8	17.2	24.4	5 <sup>d</sup>	5 <sup>d</sup>	20.1	28.5	3 <sup>d</sup>	5 <sup>d</sup>	
10.1	$\infty$	14	8	18.9	$\infty$	12	8	(24.4 B) <sup>b</sup>		2 <sup>d</sup>	5 <sup>d</sup>	(28.5 B) <sup>b</sup>		4 <sup>d</sup>	5 <sup>d</sup>	
On Screen	24			26				21				19				24
Off Screen	8 <sup>a</sup>			6 <sup>a</sup>				11 <sup>c</sup>				13 <sup>c</sup>				8 <sup>c</sup>
Total	32	32			32				32	32				32	32	
$P(\chi^2)$	0.05			0.75				0.4				0.25				
$P(\bar{x})$	0.27			0.17				0.02				0.01				

<sup>a</sup>Off screen in outermost zone.

<sup>c</sup>Off screen; zone unknown.

<sup>b</sup>Outside  $r_1$  but on screen.

<sup>d</sup>Within zone and on screen.

$P(\chi^2)$  probability of obtaining as bad or worse fit between observed and expected numbers.

$P(\bar{x})$  probability of obtaining mpi as far or farther from vertical center line of target.

~~SECRET~~ INFORMATION

TABLE A5

COMPARISON OF OBSERVED NUMBER OF SHOTS INSIDE ZONES BOUNDED BY CIRCLES OF RADII  $r_1$ , AND  $r_2$ , IN., WITH NUMBER EXPECTED FROM BIVARIATE DISTRIBUTION WITH RADIAL STANDARD DEVIATION  $\sigma_r$ ; AT FOUR RANGES, R, IN YD: TEST 1

(A) Marksmen Individually  $\sigma_r = 9.0 R/100$  ( $\sigma_r$  in in.)  
 $(\sigma_x = \sigma_y = 6.36 R/100, \text{ in.})$

R (yd)		110				205				265				310			
$\sigma_r$		9.9				18.4				23.9				27.9			
Zone		No. in Zone		Zone		No. in Zone		Zone		No. in Zone		Zone		No. in Zone			
$r_1$	$r_2$	Obsd	Exptd	$r_1$	$r_2$	Obsd	Exptd	$r_1$	$r_2$	Obsd	Exptd	$r_1$	$r_2$	Obsd	Exptd		
0	5.3	18	14	0	9.9	11	18	0	12.8	15	18	0	15.0	22	20		
5.3	8.2	10	14	9.9	15.4	10	18	12.8	19.9	18 <sup>d</sup>	18 <sup>d</sup>	15.0	23.2	14 <sup>d</sup>	16 <sup>d</sup>		
8.2	11.7	11	14	15.4	21.8	13 <sup>d</sup>	15 <sup>d</sup>	19.9	28.0	20 <sup>d</sup>	14 <sup>d</sup>	23.2	32.9	15 <sup>d</sup>	16 <sup>d</sup>		
11.7	$\infty$	17	14	(21.8 B) <sup>b</sup>		24 <sup>d</sup>	13 <sup>d</sup>	(28.0 B) <sup>b</sup>		12 <sup>d</sup>	12 <sup>d</sup>	(32.9 B) <sup>b</sup>		10 <sup>d</sup>	12 <sup>d</sup>		
On Screen	56			58	64			65	62			61	64				
Off Screen	0			14 <sup>a</sup>	8 <sup>a</sup>			7 <sup>a</sup>	10 <sup>a</sup>			19 <sup>a</sup>	16 <sup>a</sup>				
Total	56	56		72	72			72	72			80	80				
$P(\chi^2)$	0.25			10 <sup>-3</sup>				0.3				0.9					
$P(\bar{x})$	0.07			0.07				0.02				0.7					

(B) Marksmen Simultaneously  $\sigma_r = 13.0 R/100$  ( $\sigma_r$  in in.)  
 $(\sigma_x = \sigma_y = 9.2 R/100, \text{ in.})$

R (yd)		110				205				265				310			
$\sigma_r$		14.3				26.6				34.5				40.3			
Zone		No. in Zone		Zone		No. in Zone		Zone		No. in Zone		Zone		No. in Zone			
$r_1$	$r_2$	Obsd	Exptd	$r_1$	$r_2$	Obsd	Exptd	$r_1$	$r_2$	Obsd	Exptd	$r_1$	$r_2$	Obsd	Exptd		
0	7.7	5	8	0	14.3	4 <sup>d</sup>	8 <sup>d</sup>	0	18.4	11	8	0	21.6	11 <sup>d</sup>	8 <sup>d</sup>		
7.7	11.9	7	8	14.3	22.2	2 <sup>d</sup>	6 <sup>d</sup>	18.4	28.7	13 <sup>d</sup>	8 <sup>d</sup>	21.6	33.6	4 <sup>d</sup>	6 <sup>d</sup>		
11.9	16.9	9 <sup>d</sup>	8 <sup>d</sup>	22.2	31.4	8 <sup>d</sup>	5 <sup>d</sup>	28.7	40.6	3 <sup>d</sup>	5 <sup>d</sup>	33.6	47.5	4 <sup>d</sup>	4 <sup>d</sup>		
(16.9 B) <sup>b</sup>		9 <sup>d</sup>	6 <sup>d</sup>	(31.4 B) <sup>b</sup>		5 <sup>d</sup>	4 <sup>d</sup>	(40.6 B) <sup>b</sup>		5 <sup>d</sup>	3 <sup>d</sup>	(47.5 B) <sup>b</sup>		6 <sup>d</sup>	2 <sup>d</sup>		
On Screen	30	30		19	23			32	24			25	20				
Off Screen	2 <sup>a</sup>	2 <sup>a</sup>		13 <sup>a</sup>	9 <sup>a</sup>			0 <sup>a</sup>	8 <sup>a</sup>			7 <sup>a</sup>	12 <sup>a</sup>				
Total	32			32	32			32	32			32	32				
$P(\chi^2)$	0.5			0.1				0.01				0.2					
$P(\bar{x})$	0.3			2 x 10 <sup>-3</sup>				0.6				0.8					

<sup>a</sup>Off screen, zone unknown.

<sup>b</sup>Outside  $r_1$  but on screen.

<sup>d</sup>Within zone and on screen.

$P(\chi^2)$  probability of obtaining as bad or worse fit between observed and expected numbers.

$P(\bar{x})$  probability of obtaining mpi as far or farther from vertical center line of target.

TABLE A6

COMPARISON OF OBSERVED NUMBER OF SHOTS INSIDE ZONES BOUNDED BY CIRCLES OF RADII  $r_1$ , AND  $r_2$ , IN., WITH NUMBER EXPECTED FROM BIVARIATE DISTRIBUTION WITH RADIAL STANDARD DEVIATION  $\sigma_r$  AT FOUR RANGES, R, IN YD: TEST 2

(A) Experts Individually  $\sigma_r = 6.9 R/100$  ( $\sigma_r$  in in.)  
 $(\sigma_x = \sigma_y = 4.87 R/100, \text{ in.})$

R (yd)		110				205				265				310						
$\sigma_r$		7.6				14.1				18.3				21.4						
Zone		No. in Zone		Zone		No. in Zone		Zone		No. in Zone		Zone		No. in Zone						
$r_1$	$r_2$	Obsd	Exptd	$r_1$	$r_2$	Obsd	Exptd	$r_1$	$r_2$	Obsd	Exptd	$r_1$	$r_2$	Obsd	Exptd					
0	4.1	15	24	0	7.6	9	16	0	9.8	20	16	0	11.5	21	20					
4.1	6.3	23	24	7.6	11.7	8	16	9.8	15.2	14 <sup>d</sup>	16 <sup>d</sup>	11.5	17.8	31	20					
6.3	9.0	22	24	11.7	16.6	9	16	15.2	21.6	14 <sup>d</sup>	13 <sup>d</sup>	17.8	25.2	18	20					
9.0	$\infty$	36	24	16.6	$\infty$	38	16	21.6	B) <sup>c</sup>	8 <sup>d</sup>	11 <sup>d</sup>	25.2	B) <sup>c</sup>	7 <sup>d</sup>	16 <sup>d</sup>					
On Screen	91					45					56	56					77	76		
Off Screen	5 <sup>a</sup>					19 <sup>a</sup>					8 <sup>b</sup>	8 <sup>b</sup>					3 <sup>b</sup>	4 <sup>b</sup>		
Total	96	96					64	64					64	64					80	80
$P(\chi^2)$	0.02					<0.001					0.71					0.02				
$P(\bar{x})$	0.25					$3 \times 10^{-6}$					0.04					$2 \times 10^{-9}$				

(B) Experts Simultaneously  $\sigma_r = 7.8 R/100$  ( $\sigma_r$  in in.)  
 $(\sigma_x = \sigma_y = 5.51 R/100, \text{ in.})$

R (yd)		110				205				265				310						
$\sigma_r$		8.6				16.0				20.7				24.2						
Zone		No. in Zone		Zone		No. in Zone		Zone		No. in Zone		Zone		No. in Zone						
$r_1$	$r_2$	Obsd	Exptd	$r_1$	$r_2$	Obsd	Exptd	$r_1$	$r_2$	Obsd	Exptd	$r_1$	$r_2$	Obsd	Exptd					
0	4.6	6	8	0	8.6	6	16	0	11.1	10	8	0	13.0	8	8					
4.6	7.1	8	8	8.6	13.3	10	16	11.1	17.2	9	8	13.0	20.1	2 <sup>d</sup>	7 <sup>d</sup>					
7.1	10.1	11	8	13.3	18.9	15	16	17.2	24.2	8 <sup>d</sup>	7 <sup>d</sup>	20.1	28.5	7 <sup>d</sup>	6 <sup>d</sup>					
10.1	$\infty$	7	8	18.9	$\infty$	33	16	24.4	B) <sup>c</sup>	1 <sup>d</sup>	6 <sup>d</sup>	28.5	B) <sup>c</sup>	8 <sup>d</sup>	5 <sup>d</sup>					
On Screen	28					58					29	29					25	26		
Off Screen	4 <sup>a</sup>					6 <sup>a</sup>					4 <sup>b</sup>	3 <sup>b</sup>					7 <sup>b</sup>	6 <sup>b</sup>		
Total	32	32					64	64					32	32					32	32
$P(\chi^2)$	0.63					<0.001					0.26					0.23				
$P(\bar{x})$	0.49					0.01					0.52					0.42				

<sup>a</sup>Off screen in outermost zone.

<sup>b</sup>Off screen, zone unknown.

<sup>c</sup>Outside  $r_1$  but on screen.

<sup>d</sup>Within zone and on screen.

$P(\chi^2)$  probability of obtaining as bad or worse fit between observed and expected numbers.

$P(\bar{x})$  probability of obtaining mpi as far or farther from vertical center line of target.

TABLE A7

COMPARISON OF OBSERVED NUMBER OF SHOTS INSIDE ZONES BOUNDED BY CIRCLES OF RADII  $r_1$ , AND  $r_2$ , IN., WITH NUMBER EXPECTED FROM BIVARIATE DISTRIBUTION WITH RADIAL STANDARD DEVIATION  $\sigma_r$  AT FOUR RANGES, R, IN YD: TEST 2

(A) Marksmen Individually  $\sigma_r = 9.0 R/100$  ( $\sigma_r$  in in.)  
 $(\sigma_x = \sigma_y = 6.36 R/100, \text{ in.})$

R(yd)		110				205				265				310			
$\sigma_r$		9.9				18.4				23.9				27.9			
Zone		No. in Zone		Zone		No. in Zone		Zone		No. in Zone		Zone		No. in Zone			
$r_1$	$r_2$	Obsd	Exptd	$r_1$	$r_2$	Obsd	Exptd	$r_1$	$r_2$	Obsd	Exptd	$r_1$	$r_2$	Obsd	Exptd		
0	5.3	13	16	0	9.9	9	18	0	12.8	32	24	0	15.0	13	20		
5.3	8.2	21	16	9.9	15.4	9	18	12.8	19.9	20	24	15.0	23.2	13 <sup>d</sup>	18 <sup>d</sup>		
8.2	11.7	16	16	15.4	21.8	12	18	19.9	28.1	27 <sup>d</sup>	20 <sup>d</sup>	23.2	32.9	17 <sup>d</sup>	14 <sup>d</sup>		
11.7	$\infty$	14	16	21.8	$\infty$	42	18	28.1	B) <sup>c</sup>	9 <sup>d</sup>	17 <sup>d</sup>	32.9	B) <sup>c</sup>	18 <sup>d</sup>	13 <sup>d</sup>		
On Screen		64		59		85		88		85		61		65			
Off Screen		0		13 <sup>a</sup>		8 <sup>b</sup>		8 <sup>b</sup>		11 <sup>b</sup>		19 <sup>b</sup>		15 <sup>b</sup>			
Total		64		72		96		96		96		80		80			
$P(\chi^2)$		0.50		<0.001		0.04		0.04		0.12		<2 x 10 <sup>-9</sup>		<2 x 10 <sup>-9</sup>			
$P(\bar{x})$		<2 x 10 <sup>-9</sup>		<2 x 10 <sup>-9</sup>		<2 x 10 <sup>-9</sup>		<2 x 10 <sup>-9</sup>		<2 x 10 <sup>-9</sup>		<2 x 10 <sup>-9</sup>		<2 x 10 <sup>-9</sup>			

(B) Marksmen Simultaneously  $\sigma_r = 13.0 R/100$  ( $\sigma_r$  in in.)  
 $(\sigma_x = \sigma_y = 9.2 R/100, \text{ in.})$

R(yd)		110				205				265				310			
$\sigma_r$		14.3				26.6				34.5				40.3			
Zone		No. in Zone		Zone		No. in Zone		Zone		No. in Zone		Zone		No. in Zone			
$r_1$	$r_2$	Obsd	Exptd	$r_1$	$r_2$	Obsd	Exptd	$r_1$	$r_2$	Obsd	Exptd	$r_1$	$r_2$	Obsd	Exptd		
0	7.7	13	8	0	14.3	16	16	0	18.5	13	8	0	21.6	13	8		
7.7	11.9	9	8	14.3	22.2	10	16	18.5	28.7	8 <sup>d</sup>	6 <sup>d</sup>	21.6	33.6	8 <sup>d</sup>	6 <sup>d</sup>		
11.9	16.9	3	8	22.2	31.4	13 <sup>d</sup>	15 <sup>d</sup>	28.7	40.6	3 <sup>d</sup>	5 <sup>d</sup>	33.6	47.5	3 <sup>d</sup>	5 <sup>d</sup>		
16.9	$\infty$	7	8	31.4	B) <sup>c</sup>	10 <sup>d</sup>	12 <sup>d</sup>	40.6	B) <sup>c</sup>	0 <sup>d</sup>	5 <sup>d</sup>	47.5	B) <sup>c</sup>	2 <sup>d</sup>	5 <sup>d</sup>		
On Screen		29		49		59		24		24		26		24			
Off Screen		3 <sup>a</sup>		16 <sup>b</sup>		6 <sup>b</sup>		8 <sup>b</sup>		8 <sup>b</sup>		6 <sup>b</sup>		8 <sup>b</sup>			
Total		32		65		65		32		32		32		32			
$P(\chi^2)$		0.09		<0.001		0.05		0.05		0.15		<2 x 10 <sup>-9</sup>		<2 x 10 <sup>-9</sup>			
$P(\bar{x})$		0.23		<2 x 10 <sup>-9</sup>		0.04		0.04		0.03		<2 x 10 <sup>-9</sup>		<2 x 10 <sup>-9</sup>			

<sup>a</sup>Off screen in outermost zone.

<sup>b</sup>Off screen, zone unknown.

<sup>c</sup>Outside  $r_1$ , but on screen.

<sup>d</sup>Within zone and on screen.

$P(\chi^2)$  probability of obtaining as bad or worse fit between observed and expected numbers.

$P(\bar{x})$  probability of obtaining mpi as far or farther from vertical center line of target.

~~CONFIDENTIAL~~  
#18550

**UNCLASSIFIED**

TABLE A8

PROBABILITIES, FOR EXPERTS FIRING INDIVIDUALLY,  
OF OBTAINING EXACTLY 1, 2, 3, 4, AND 5 HITS  
ON TYPE E SILHOUETTE WITH FIVE-SHOT PATTERN  
SALVO FOR INDICATED TARGET RANGES

Range, yd	Exact No. of Hits					At least 1 hit
	1	2	3	4	5	
100	0.040	0.002	0.049	0.420	0.489	1.000
150	0.174	0.041	0.269	0.506	0.000	0.990
200	0.325	0.145	0.398	0.091	0.000	0.959
250	0.423	0.353	0.125	0.000	0.000	0.901
300	0.546	0.280	0.000	0.000	0.000	0.826
350	0.524	0.165	0.000	0.000	0.000	0.689
400	0.499	0.087	0.000	0.000	0.000	0.586

TABLE A9

PROBABILITIES, FOR MARKSMEN FIRING INDIVIDUALLY,  
OF OBTAINING EXACTLY 1, 2, 3, 4, AND 5 HITS  
ON TYPE E SILHOUETTE WITH FIVE-SHOT PATTERN  
SALVO FOR INDICATED TARGET RANGES

Range, yd	Exact No. of Hits					At least 1 hit
	1	2	3	4	5	
100	0.111	0.011	0.093	0.415	0.360	0.990
150	0.271	0.066	0.250	0.350	0.000	0.937
200	0.388	0.122	0.284	0.058	0.000	0.852
250	0.434	0.240	0.085	0.000	0.000	0.759
300	0.482	0.186	0.000	0.000	0.000	0.668
350	0.436	0.108	0.000	0.000	0.000	0.544
400	0.398	0.057	0.000	0.000	0.000	0.455

**UNCLASSIFIED**

~~CONFIDENTIAL~~